

Owner's Manual

*Compatible with C/Ku Band
On Screen Display
Category Menu Selection*

•

TRX-500 Satellite Receiver

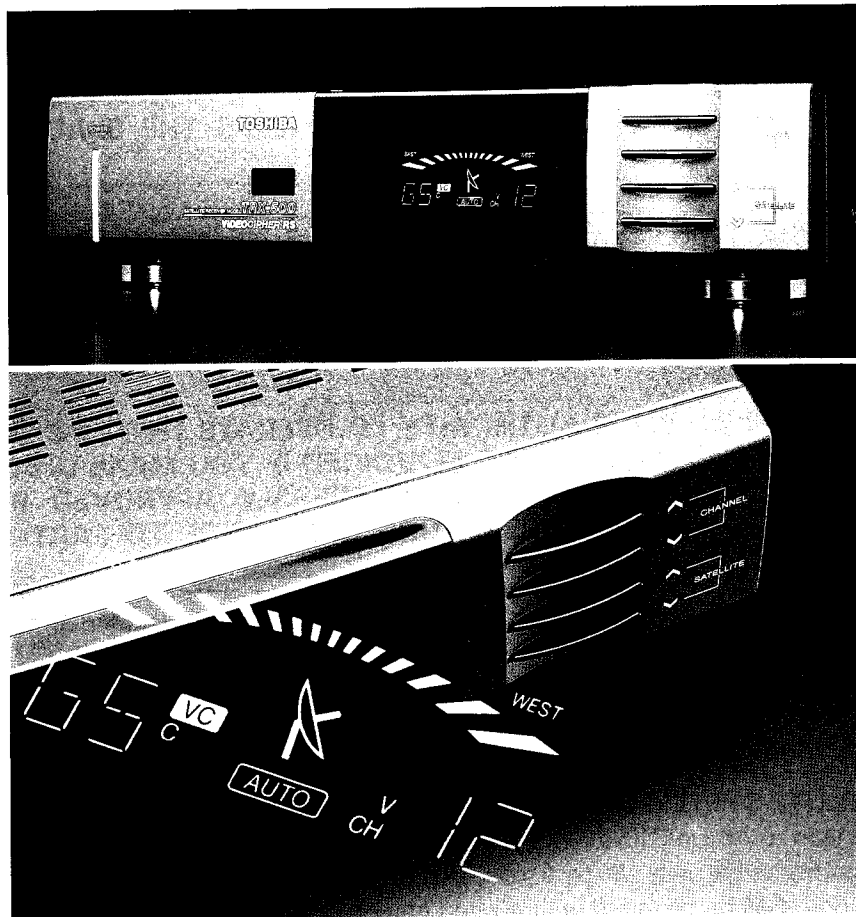

TOSHIBA

PLEASE READ

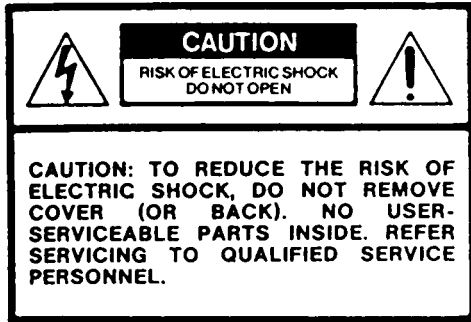

The lightning flash with arrowhead symbol, within a triangle, is intended to alert the user to the presence of uninsulated "dangerous voltage" within the product's enclosure that may be of sufficient magnitude to constitute a risk of electric shock to persons.



The exclamation point within a triangle is intended to alert the user to the presence of important operating and maintenance (servicing) instructions in the literature accompanying the appliance.

WARNING: TO REDUCE THE RISK OF FIRE OR ELECTRIC SHOCK, DO NOT EXPOSE THIS APPLIANCE TO RAIN OR MOISTURE. DANGEROUS HIGH VOLTAGES ARE PRESENT INSIDE THE ENCLOSURE. DO NOT OPEN THE CABINET. REFER SERVICING TO QUALIFIED PERSONNEL ONLY.

CAUTION: TO PREVENT ELECTRIC SHOCK, DO NOT USE THIS POLARIZED PLUG WITH AN EXTENSION CORD OR OTHER OUTLET UNLESS THE BLADES CAN BE FULLY INSERTED.

ATTENTION: POUR PREVENIR LES CHOCS ELECTRIQUES, NE PAS UTILISER CETTE FICHE POLARISEE AVEC UN PROLONGATEUR, UNE PRISE DE COURANT OU UNE AUTRE SORTIE DE COURANT, SAUF SI LES LAMES PEUVENT ETRE INSEREES A FOND SANS EN LAISSER AUCUNE PARTIE A DECOUVERT.

USER-INSTALLER CAUTION: YOUR AUTHORITY TO OPERATE THIS FCC CERTIFIED EQUIPMENT COULD BE VOIDED IF YOU MAKE CHANGES OR MODIFICATIONS NOT EXPRESSLY APPROVED BY THIS PARTY RESPONSIBLE FOR COMPLIANCE TO PART 15 OF THE FCC RULES.

In the spaces provided below, record the VCII Plus Address No. and Serial No. located at the rear of your satellite receiver.

VCII PLUS Address No. _____ Serial No. _____ (Printed on a white label)
Retain this information for future reference.

NOTE TO THE SATELLITE SYSTEM INSTALLER

Please pay close attention to Article 810-20 of the National Electrical Code that provides guidelines for proper installation of antenna discharge units. In particular, this article specifies that each conductor of a "lead in" from an outdoor antenna shall be provided with a listed antenna discharge unit except where the lead in conductors are enclosed in a continuous metallic shield that is effectively grounded.

NOTE TO THE CATV SYSTEM INSTALLER

For CATV system installations, please pay close attention to Article 820-40 of the National Electrical Code that provides guidelines for proper grounding and, in particular, specifies that the cable ground shall be connected to the grounding system of the building, as close to the point of cable entry as practical.

TABLE OF CONTENTS

FEATURES & CONTROLS	3-7
FEATURES	3
INDICATION OF CONTROLS	4-7
FRONT PANEL	4
FRONT PANEL DISPLAY	4
REAR PANEL	5-6
REMOTE CONTROL	7
SETUP	8-14
INSTALLATION	8-11
INITIAL SETUP	12-14
BASIC OPERATION	15-17
ADVANCED OPERATION	18-51
CATEGORY SELECTION	18-20
FAVORITE PROGRAM	21-22
PARENTAL CONTROL	23-24
VIDEO FINE TUNING	25
DESCRAMBLER OPERATION	26-40
MAIN FUNCTIONS	41-51
OTHERS	52-54
TROUBLESHOOTING	52-53
SPECIFICATIONS	54

QUICK REFERENCE

ANTENNA LOCK (SEE PARENTAL CONTROL)	16
AUDIO (AUDIO PROGRAM SELECTION)	16
(CHANGE AUDIO PROGRAM)	50
AUTO MODE (SEE RECEIVER MODE)	44
AUTO TUNING	44
CATEGORY	18
CHANNEL LOCKOUT (SEE PARENTAL CONTROL)	44
CHANNEL SCAN	48
CHANNEL SKIP	21
FAVORITE CHANNELS	47
INITIALIZE DATA	44
INPUT MODE (A/B SWITCH CONTROL)	46
MOTOR LIMITS (CHANGE MOTOR LIMITS)	13
(SETTING MOTOR LIMITS)	23
PARENTAL CONTROL	45
POLARITY (POLARITY/SKEW & VIDEO FINE TUNING)	51
PROGRAM MODE (GO TO THE PROGRAM MODE)	49
REALIGN MEMORY	47, 51
RECEIVER MODE	53
SATELLITE (DELETING A SATELLITE)	53
(FINE TUNING A SATELLITE)	53
(PROGRAMMING A NEW SATELLITE)	13
(SATELLITE POSITION MEMORY)	15
(SATELLITE SELECTION)	45
SKEW (POLARITY/SKEW & VIDEO FINE TUNING)	48
SKIP TUNING	25, 45
VIDEO FINE TUNING (POLARITY/SKEW & VIDEO FINE TUNING)	

FEATURES

Thank you for purchasing the TOSHIBA TRX-500. This system has superior performance and many advanced functions. We are confident that you will be fully satisfied with your new TRX-500. This system has the following features.

Compatible with VIDEOCIPHER® RS Descrambler

Allows enjoyment of VideoCipher® RS programming.

Built-in Programmable Antenna Positioner with Power Supply

24 C-band satellites and 24 Ku-band satellites can be programmed.

Compatible with C/Ku band

Color On Screen Display

Displays various functions such as satellite name, channel, audio, etc.

FL (FLUORESCENT) Multi-Function Display

Displays satellite name, channel, etc.

20 Favorite Channel Memory

Stores satellite position, channel number and Audio.

Category Menu Selection

Initially, satellite programs are factory programmed in 10 different categories. Allows easy selection of satellite programs.

Full Function Remote Control

Additional Features

Frequency Synthesized Tuning System

Parental Control (Antenna lock, Channel lockout)

Auto Tuning

Channel Scan

INDICATION OF CONTROLS

FRONT PANEL

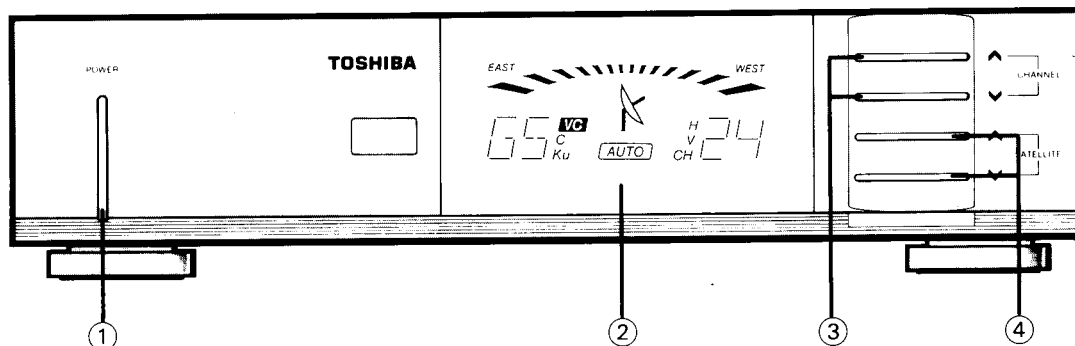

① POWER BUTTON

Turn the receiver on or off.

② FRONT PANEL DISPLAY

Displays current satellite information.

③ CHANNEL BUTTON

Selects channels up or down.

④ SATELLITE BUTTON

These buttons select the next programmed satellite to the east or west. When the button is released, the dish will automatically begin moving to the desired satellite.

FRONT PANEL DISPLAY

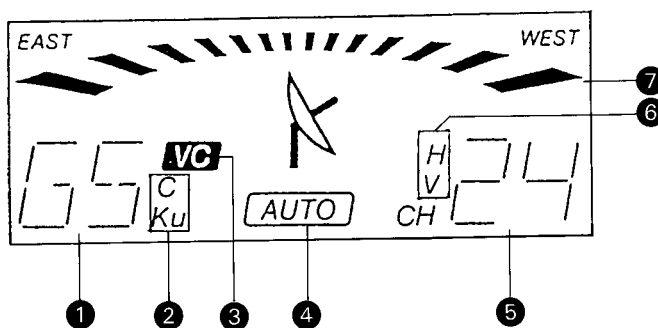

① SATELLITE NAME DISPLAY

Displays the receiving satellite which is being received.

② C/Ku BAND INDICATOR

Indicates the satellite band being received.

③ VIDEOCIPHER® INDICATOR

Indicates the system is receiving a VideoCipher® RS signal.

④ AUTO MODE INDICATOR

Indicates the AUTO mode has been selected.

⑤ CHANNEL DISPLAY

Displays the satellite channel being received.

⑥ POLARITY INDICATOR

Indicates the channel polarity. Displays "H" for horizontal and "V" for vertical polarity.

⑦ ANTENNA MOVEMENT INDICATOR

The display flashes when the dish is moving east or west.

INDICATION OF CONTROLS

REAR PANEL

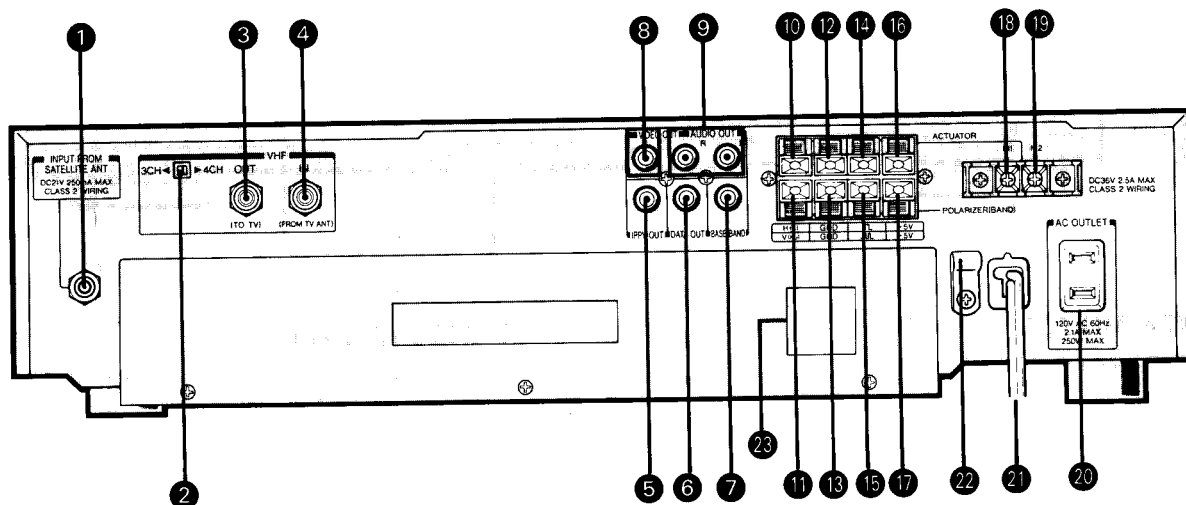

1 INPUT

This connector accepts the input signal from the satellite antenna.

2 CHANNEL 3/4

The output of the modulator 3 (VHF OUT) is controlled by this switch. TV reception on channel 3 or 4 is possible.

3 VHF OUT

Channel 3 or 4 modulated VHF signal output. Connect to the VHF input on a television set.

4 VHF IN

A VHF signal input. Connect to a VHF antenna or cable system.

5 IPPV OUT

This phono connector provides output data from the VideoCipher® RS module.

6 DATA OUT

This phono connector provides output data from the VideoCipher® RS module.

7 BASE BAND

This phono connector provides filtered, unclamped composite baseband video output to an external descrambler.

8 VIDEO OUT

This phono connector provides the video output to a VCR or a monitor.

9 AUDIO OUT

These phono connectors provide the audio outputs, left and right, from the receiver. The output level can be adjusted from the remote control.

10 H (C)

This output provides +12V to an external H/V switch when:

- V/H is selected in the INPUT MODE and the H polarity is selected.
- C/Ku is selected in the INPUT MODE and a C-band satellite is selected.

11 V (Ku)

This output provides +12V to an external H/V switch when:

- V/H is selected in the INPUT MODE and the V polarity is selected.
- C/Ku is selected in the INPUT MODE and a Ku-band satellite is selected.

12 GND

An actuator position feedback line used in conjunction with 14 alone or 14 and 16.

13 GND

This is the return line for 10 11 15 17.

14

This is the actuator return pulse input.

15 

This terminal is the output control for the polarizer.

16 +5V

This terminal is the 5V supply for a hall effect sensor.

17 +5V

This terminal is the 5V supply for the polarizer.

18 M1

Combined with 19, this output controls the motor direction and dynamic braking. When the EAST is pressed, + 36V (MAX) appears at the M1 relative to M2.

19 M2

Combined with 18, this output controls the motor direction and dynamic braking. When the WEST is pressed, + 36V (MAX) appears at the M2 relative to M1.

20 AC OUTLET

Provides 120V AC (250W MAX) as long as the line cord is plugged into an active wall outlet.

21 LINE CORD

120V AC, 60Hz (nominal) input.

22 CABLE HOLDER

This is used to secure the cable from satellite antenna.

23 TELEPHONE JACK

This connects your VideoCipher® RS module to your telephone line when utilizing pay-per-view services.

REMOTE CONTROL

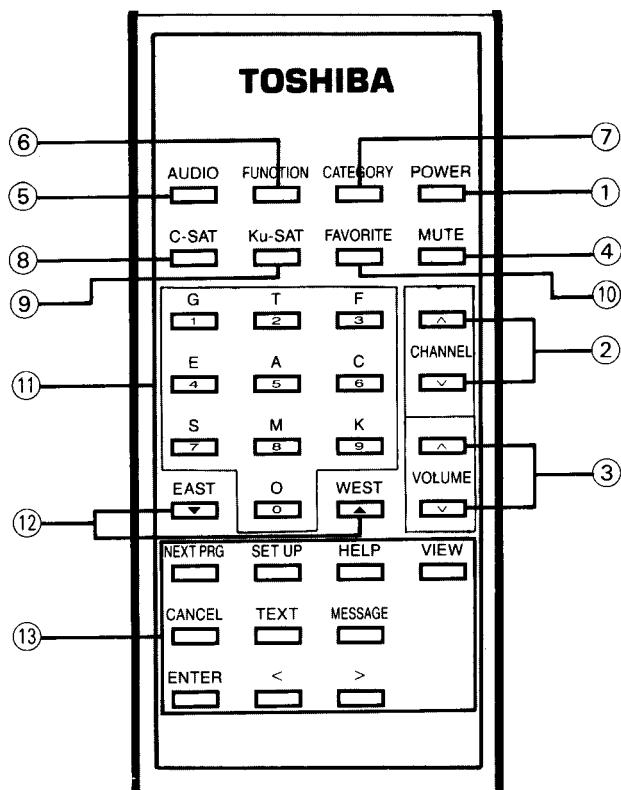

① POWER BUTTON

This button turns the receiver on or off.

② CHANNEL BUTTONS

These buttons allow channel scanning up or down.

③ VOLUME BUTTONS

These buttons adjust the audio level up or down.

④ MUTE BUTTON

This button mutes the sound.

⑤ AUDIO BUTTON

Pressing this button, followed by the ALPHANUMERIC buttons or EAST or WEST , selects preprogrammed audio subcarriers.

⑥ FUNCTION BUTTON

Pressing this button, selects the MAIN menu.

⑦ CATEGORY BUTTON

Pressing this button, followed by an ALPHANUMERIC button, selects a desired satellite program by category.

⑧ C-SAT BUTTON

Pressing this button, followed by the ALPHANUMERIC buttons or EAST or WEST , selects C-band satellites.

⑨ Ku-SAT BUTTON

Pressing this button, followed by the ALPHANUMERIC buttons or EAST or WEST , selects Ku-band satellites.

⑩ FAVORITE BUTTON

Pressing this button, followed by the ALPHANUMERIC buttons, selects a favorite channel. Up to 20 channels can be stored in the receiver's memory.

⑪ ALPHANUMERIC BUTTONS

These 10 buttons are used to do the following.

- (1) To select a satellite and a channel directly.
- (2) To select a favorite channel.
- (3) To select a satellite program by category.
- (4) To select an audio program.
- (5) To select MAIN FUNCTIONS.

⑫ ANTENNA EAST/WEST BUTTONS

This button is used to move the antenna. When pressed with , , this button cycles through programmed satellite positions.

⑬ VIDEOCIPHER® RS CONTROLS

These buttons perform those functions associated with the operation of the VideoCipher® RS Descrambler. These buttons are operative only when receiving VideoCipher signals. See page 26.

Note: , and are also used for other functions.

If the wrong key was pressed or the operation of the receiver was unknown, press . will clear any on screen display.

■ INSTALLING THE BATTERIES:

- ① Press down and pull off.
- ② Insert two AAA batteries, observing the polarity shown by the diagram inside the battery compartment.

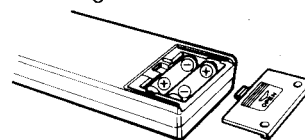

INSTALLATION

1. CONNECTIONS TO A SATELLITE ANTENNA

(1) SINGLE LNB

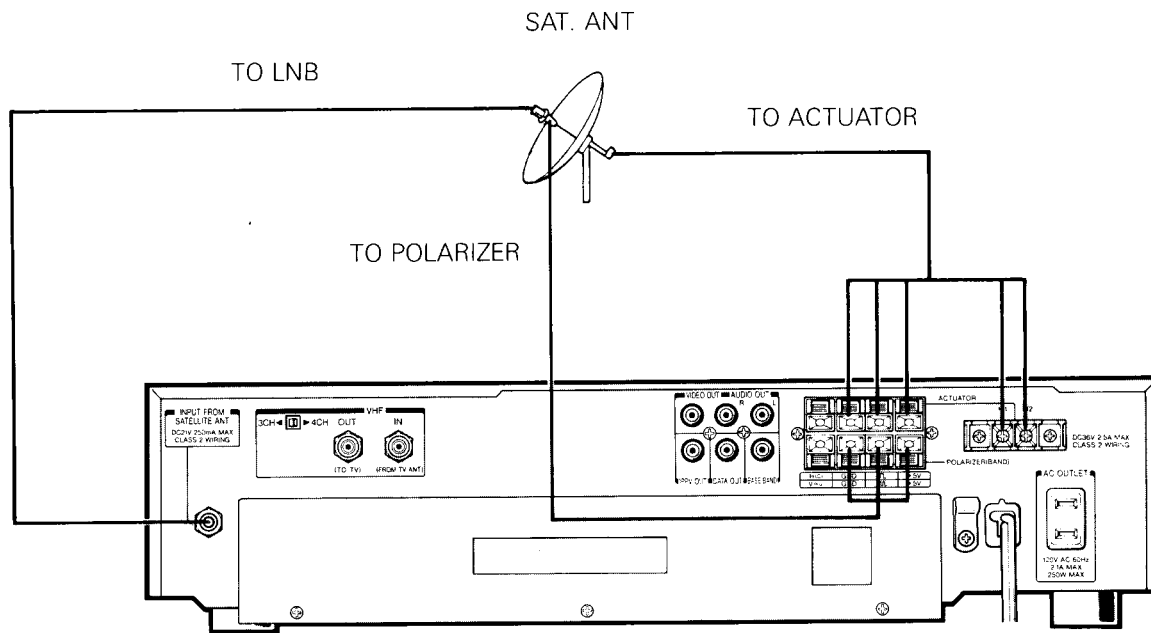

(2) DUAL LNBs (C-Band only or Ku-Band only)

Set the INPUT MODE to V/H.
See page 13.

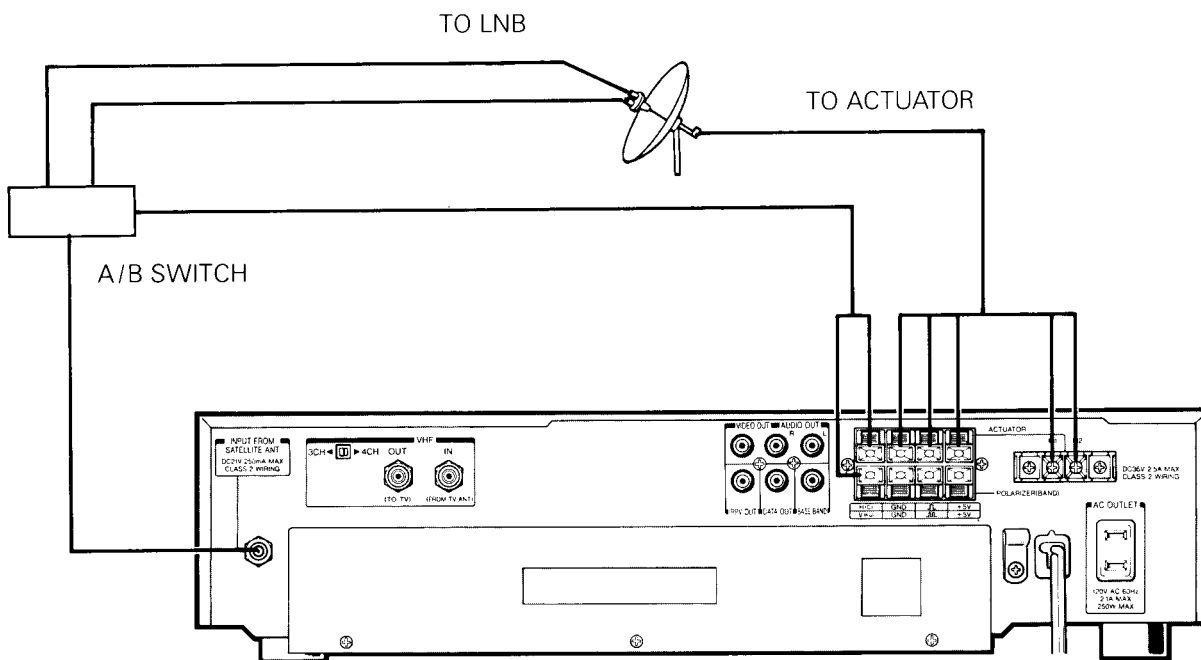

SET UP

INSTALLATION

(3) DUAL LNBS (Single C-band and Single Ku-band LNBS)

Set the INPUT MODE to C/Ku.

See page 13.

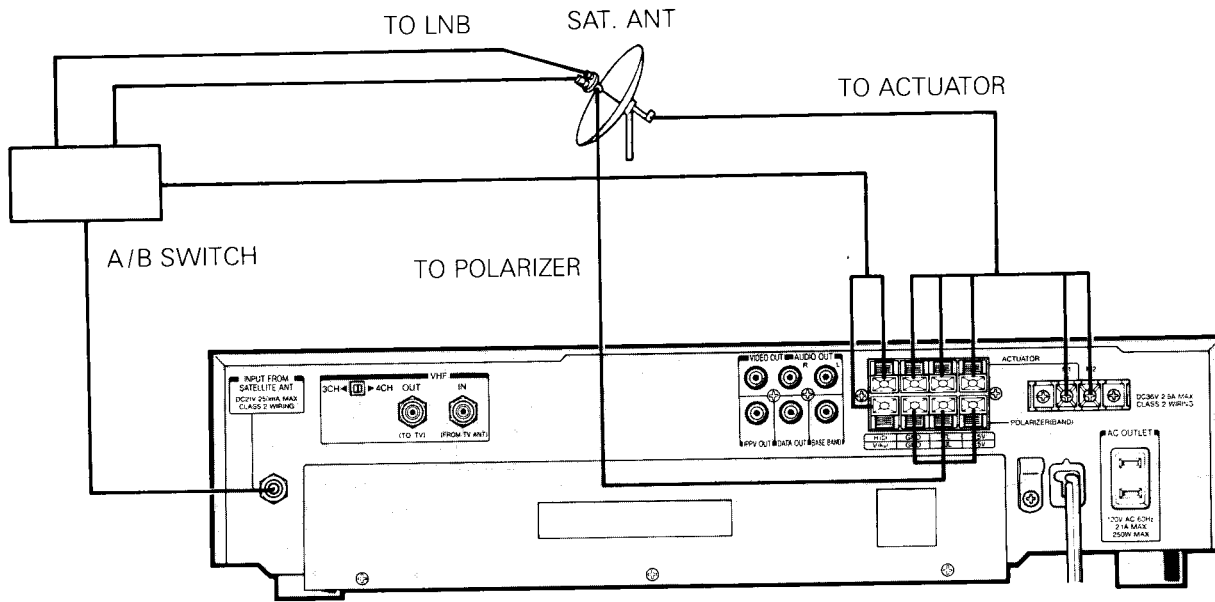

2. CONNECTION TO OTHER AV COMPONENTS

EX. 1

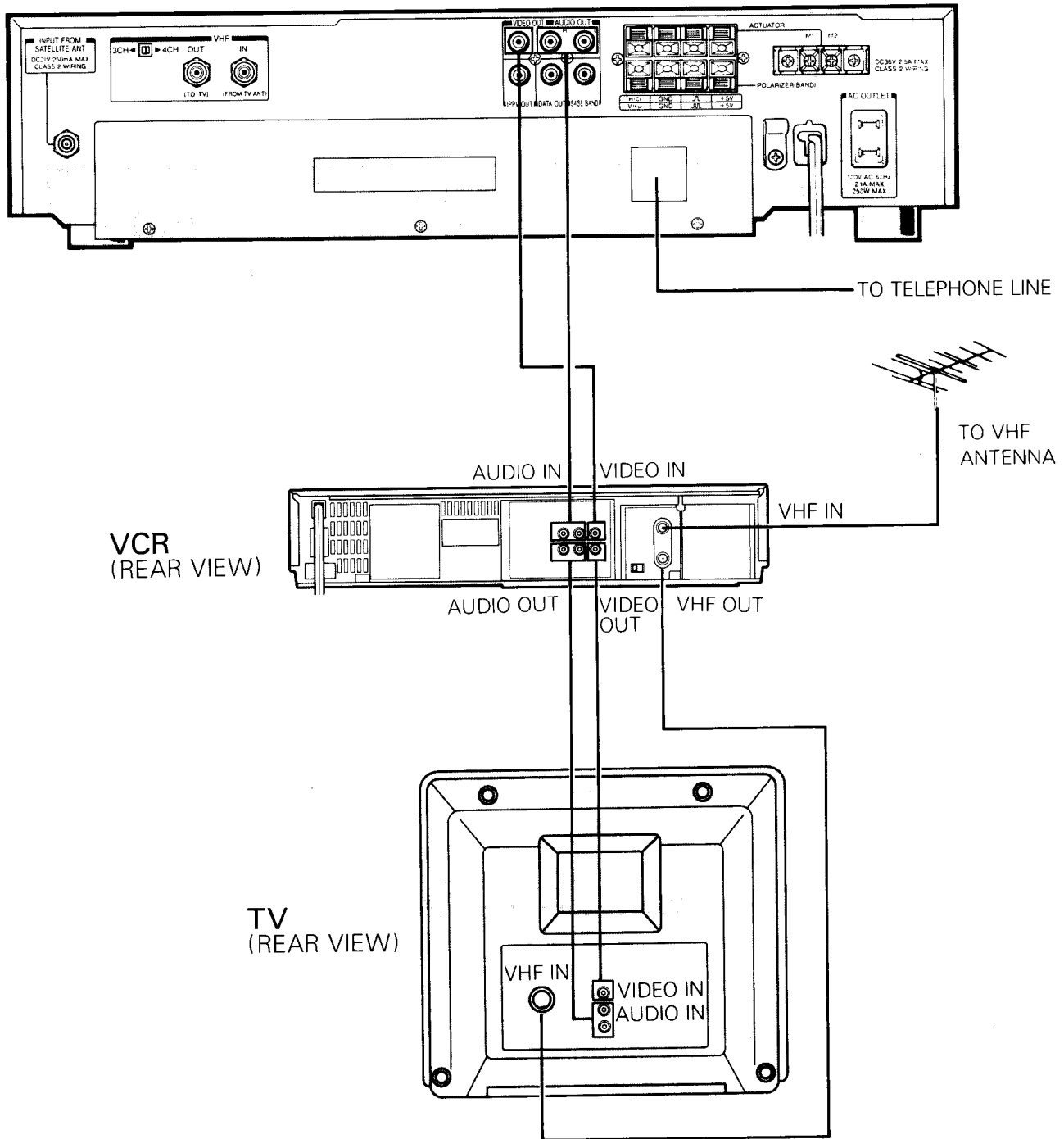

SET UP

- When recording a program on a VCR, set the TRX-500's volume control to 63 (max).

INSTALLATION

EX. 2 When using a television without audio and video inputs.

NOTE:

When the receiver is turned on, satellite programs can be watched on TV.
When the receiver is turned off, the VHF TV programs can be watched on TV.

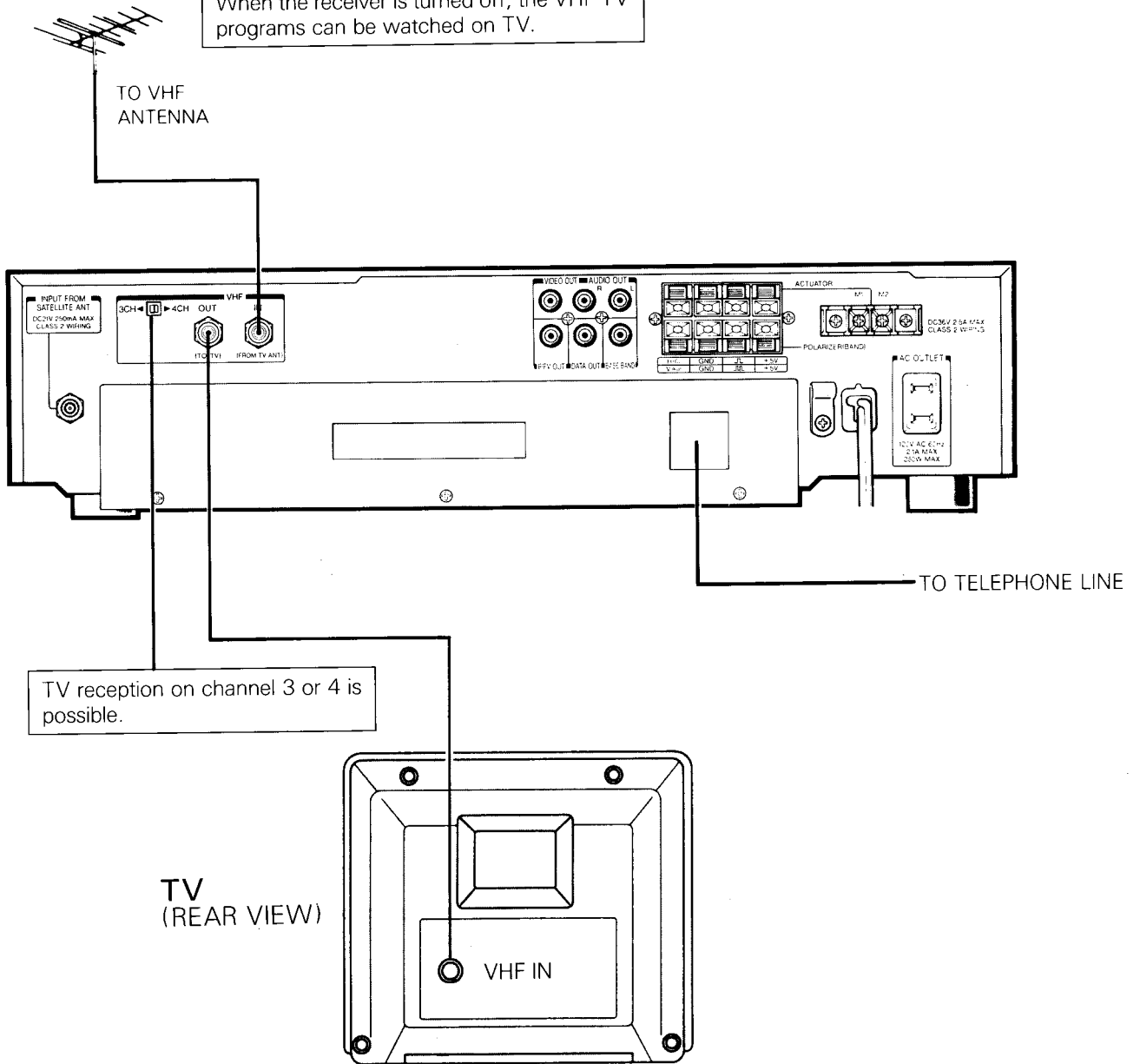

INITIAL SETUP

The following initial setup procedures must be completed before attempting to operate the receiver. Under normal circumstances, there should be no need to change these programs after the initial setup.

1. POWER ON

Turn on the receiver and TV. Change the input of the TV to correspond with the input of the satellite receiver. (Ex. Video 1, 2 or Channel 3/4 when using the RF modulator.)

2. SET TO THE PROGRAM MODE

Confirm that the receiver is in the PROGRAM mode by pressing the function button. Lock at the bottom of the screen for "AUTO MODE" or "PROGRAM MODE". If the receiver is in the AUTO mode ("AUTO" is indicated), set the receiver to the PROGRAM mode as follows. If the receiver is in the AUTO mode ("AUTO" is indicated), set the receiver to the PROGRAM mode as follows.

- Press **FUNCTION**, **5** and the display will be as shown at right.
- Select **2** and press **ENTER**.

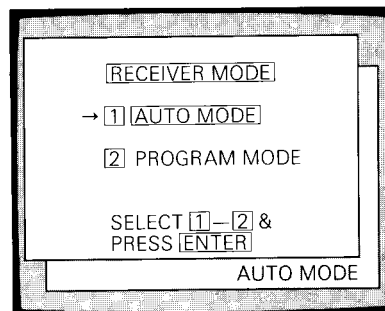

3. CHECK ACTUATOR WIRING

Confirm that when EAST **▼** is pressed, the antenna moves to the east. If not, swap the connection of M1 and M2 on the rear panel of the receiver.

4. INITIALIZE DATA

- Press **FUNCTION**, **4** and the display will be as shown at right.
- Select **1** and press **ENTER**. At this time all data is initialized as factory preset. The display will be as shown at right.

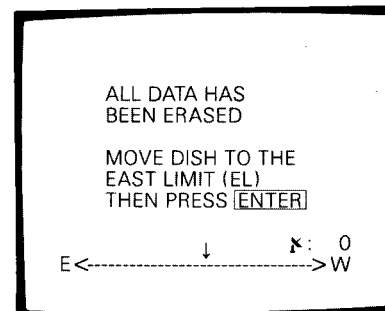
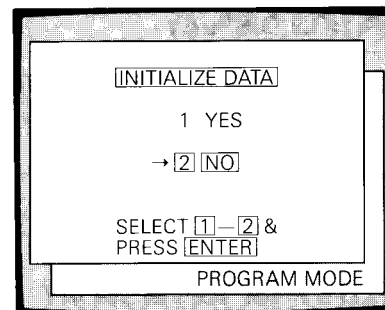

SET UP

INITIAL SETUP

5. SELECTING THE INPUT MODE FOR YOUR SYSTEM

- (a) Press **FUNCTION**, **1**, **3** and the display will be as shown at right.
- (b) By pressing EAST **▼** or WEST **▲**, select C/Ku or V/H in accordance with the antenna and LNB configuration being used.
- (c) Press **VIEW** to return.

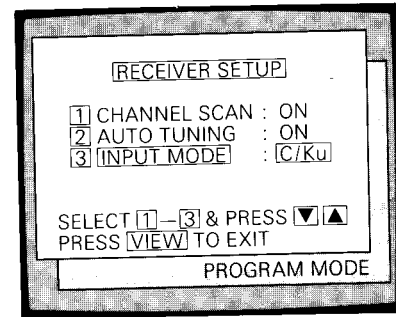

6. SETTING MOTOR LIMITS

The motor limits must be set to prevent the dish from traveling too far. The motor limits should be set so that the dish can aim anywhere between the farthest east satellite and the farthest west satellite, without hitting any objects such as the ground or a fence.

- (a) The east limit must be set first. Move the dish east until "No Return Pulse" is displayed on screen. At this time press WEST **▲** for 1~2 seconds. This is the east limit. Press **ENTER** to store this position.
Note: To avoid possible damage to an actuator without a mechanical stop, an additional person should be located near the dish to notify the installer the actuator is reaching its limit.
- (b) Repeat step (a) to enter the west limit. The motor limit setup is over.

DISH POSITION DISPLAY

The display shows the relative dish position. When the motor limits are entered, the east limit will always be 0.

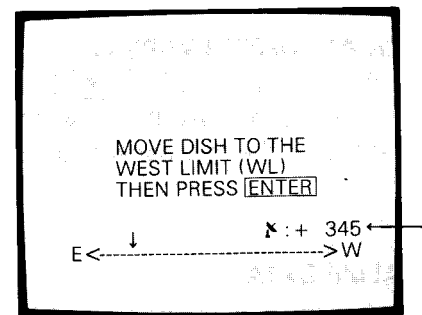

7. SATELLITE POSITION MEMORY

Up to 48 satellite can be programmed (C-band: 24, Ku-band: 24). For the satellites listed on the one sheet manual, the 2-digit ALPHANUMERIC codes designate the band, polarity and audio/video frequencies which have been stored in memory for each of the satellites. Therefore, it is necessary to program only the satellite locations for these satellites.

- (a) Press **FUNCTION**, **1**. The display will be as shown at right.

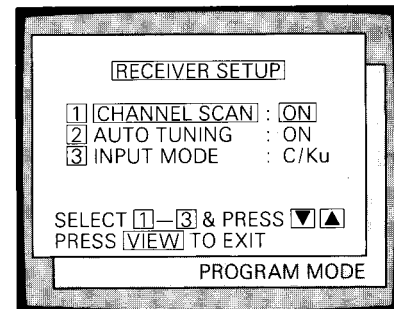

- (b) Select and by pressing EAST or WEST , turn the CHANNEL SCAN ON.
- (c) Select and by pressing EAST or WEST , turn the AUTO TUNING ON.

(d) Press to exit.

- (e) Select C or Ku-band by pressing or and select a satellite name by pressing or until the desired satellite name appears, or enter the satellite designation (2 digit) by the ALPHANUMERIC buttons.

Ex. When GALAXY 1 is selected, press , , .

- (f) By pressing and holding EAST or WEST , move the dish to the selected satellite until a picture is visible. To correctly identify the satellite, please refer to a current programming guide.

Press , the skew and satellite positioner will automatically adjust to deliver the best possible picture. When completed, the antenna position is stored.

To program additional satellite positions, repeat step (e) through (f).

- (g) Press , , , to return to the AUTO MODE.

The INITIAL SETUP is now complete.

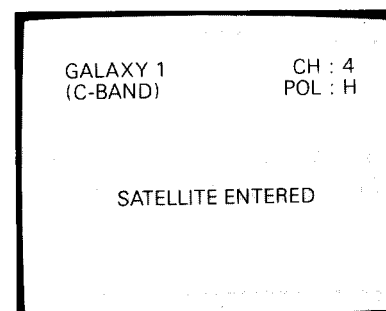
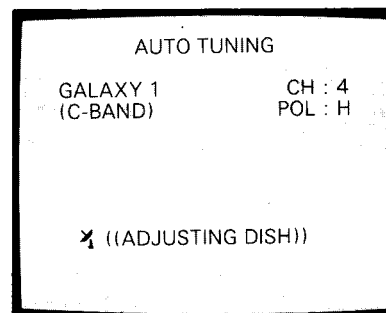
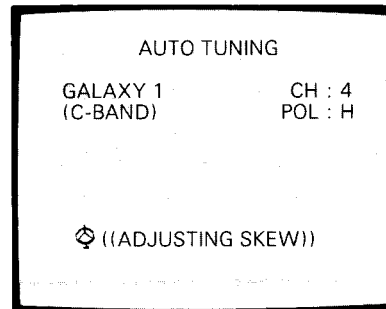
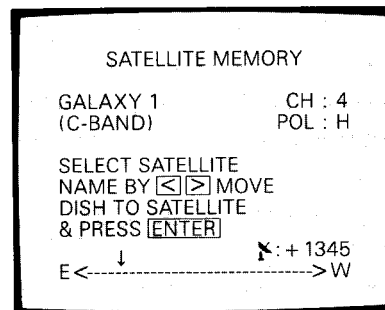

SETUP

BASIC OPERATION

The following describes the basic operation of this receiver assuming that the operation of INSTALLATION section has been properly completed.

1. POWER ON

Press **POWER** and the front panel display will illuminate. Check that "AUTO" appears on the display. If not, set the receiver to the AUTO mode. See page 47.

2. SATELLITE AND CHANNEL SELECTION

(1) Satellite selection

There are two ways to select a satellite.

● Direct access

Press **C-SAT** or **Ku-SAT** and input the desired satellite designation (2-digit as G1, T3, etc.) by pressing the ALPHANUMERIC buttons. Then the dish will move to the desired satellite.

● Next access

Press **C-SAT** or **Ku-SAT** and press and hold EAST **▼** or WEST **▲** until the desired satellite name appears on the display. After releasing the button, the dish will move to the desired satellite.

Note: If it is desired to view the programmed satellite list, press **C-SAT** or **Ku-SAT** twice, the list will then be displayed on the TV screen. Press **<** or **>** to see the next or previous satellite list.

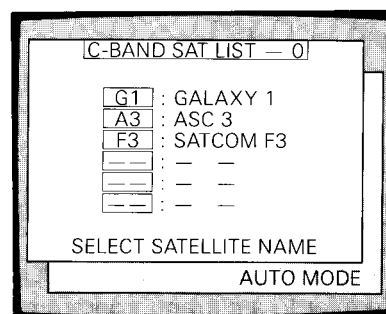

Ex. When G1, C-BAND is selected.

Press **C-SAT**, **G**, **1** or press **C-SAT**, and hold EAST **▼** or WEST **▲** until G1 is displayed on the front panel and on screen.

When the dish is moving to the selected satellite, the GRAPHIC SCREEN will appear on TV, as shown at right. The GRAPHIC SCREEN can be turned off. (Page 48)

After the dish reaches the selected satellite position, (in this case, G1), the display will change.

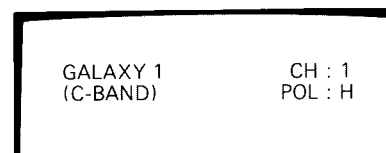
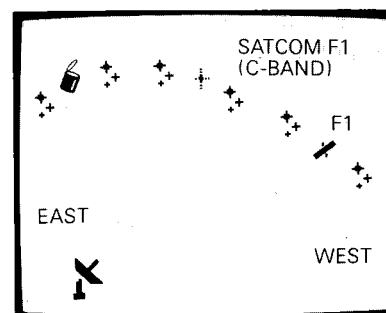
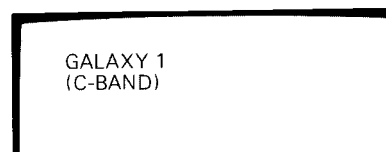

(2) Channel selection

There are two ways to select a channel.

- Direct access
Enter the desired channel number by pressing the ALPHANUMERIC buttons.
- Up, down access
Press CHANNEL or until the desired channel appears.

When a channel is selected, the number will be displayed as shown at right.

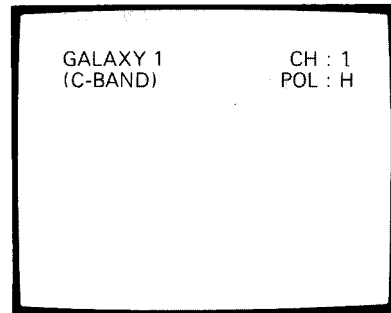

3. AUDIO PROGRAM SELECTION

This receiver has 20 (0—19) AUDIO PROGRAMS.

By using this AUDIO PROGRAM function, the desired audio data can be selected easily.

There are two ways to select an audio program.

● DIRECT ACCESS

- (a) By pressing twice, the AUDIO PROGRAM LIST will be displayed.

Press to see the next or previous AUDIO PROGRAM LIST.

- (b) Select the desired program number.

● UP/DOWN ACCESS

- (a) By pressing and holding EAST or WEST , the AUDIO PROGRAM can be changed.

Note: AUDIO PROGRAM 0 (VC AUDIO) is only for the VideoCipher® II RS. The AUDIO PROGRAM is automatically set to AUDIO PROGRAM 0 when receiving a VideoCipher® II RS program. Initially, the AUDIO PROGRAM is set as shown at right. The AUDIO PROGRAMS 5—19 can be changed. 0—4 cannot be changed.

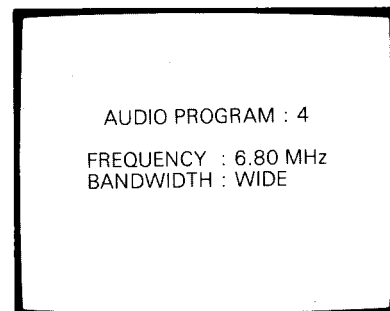
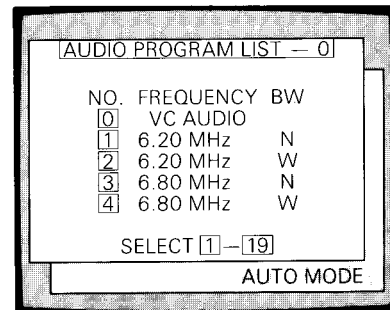

BASIC OPERATION

4. VOLUME AND MUTE CONTROLS

Press VOLUME or button to adjust the audio to a comfortable listening level.

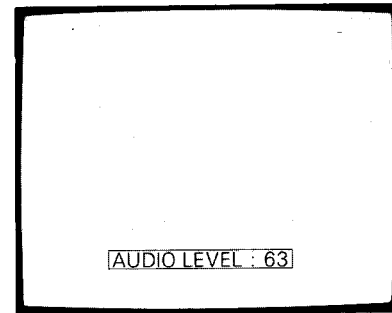

The volume reference level, 0—63 will change by pressing VOLUME or .

Press to turn off the audio. The display will be as shown at right. Press again to return to the previous volume level.

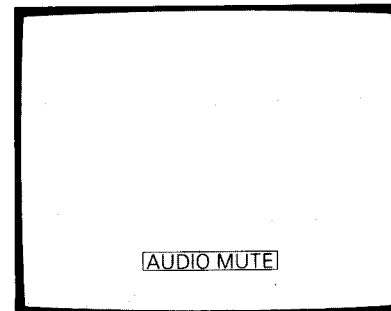

5. MOVING THE DISH

To move the dish, use EAST or WEST .

Note: If the wrong key was pressed or an undesired on screen display appears, press . VIEW will clear any on screen display.

If "NO RETURN PULSE" is displayed on screen when a satellite is selected or the dish is moved, check the antenna and actuator connections.

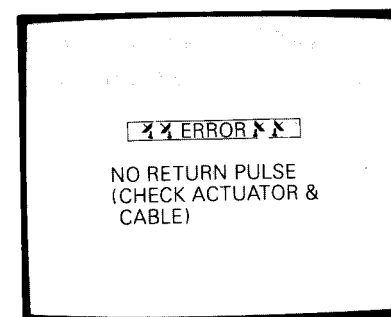
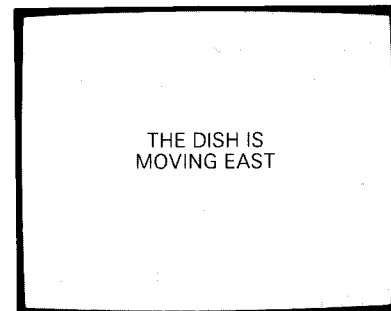

CATEGORY SELECTION

The satellite programs are stored in 10 different categories. (Refer to the supplied PROGRAM NAME LIST.) By using this function, it is possible to select the desired satellite program very easily. If desired, the factory programmed data can be changed. It is possible to store up to 100 satellite programs.

1. SELECTION

(a) Press **CATEGORY** and the category list will be displayed as shown at right.

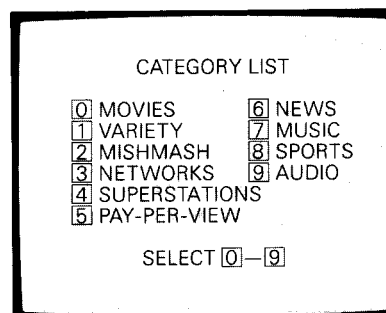

(b) Select the desired category number and the program name list will be displayed as shown at right. Press **<** **>** to see the next or previous list. Select the desired program number.

Ex. When **0** is selected.

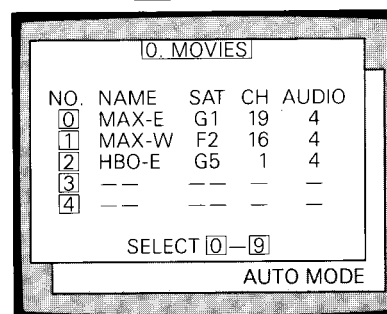

CATEGORY SELECTION

2. CHANGING A PROGRAM

Initially, satellite programs have been factory preset. If desired, they can be re-programmed as follows.

Note: When a service moves satellites or transponder, be sure to change the same program in the FAVORITE CHANNELS. This is not changed automatically. Using CHANGING A PROGRAM has no effect on data stored in the FAVORITE CHANNELS.

(1) TO STORE A PROGRAM

- (a) Set the receiver to the AUTO mode.
Move the dish to the desired satellite and channel.
- (b) Receive the desired satellite, channel and audio that is to be stored.
- (c) Press **FUNCTION**, **3**, **2** and the display will be as shown at right.

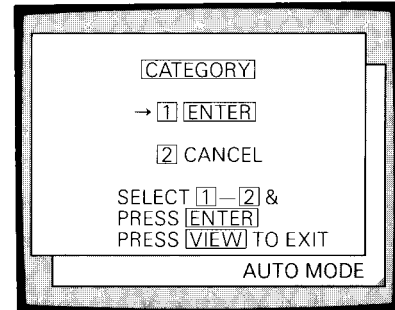

- (d) Select **1** and press **ENTER**. The category list will be displayed as shown at right.

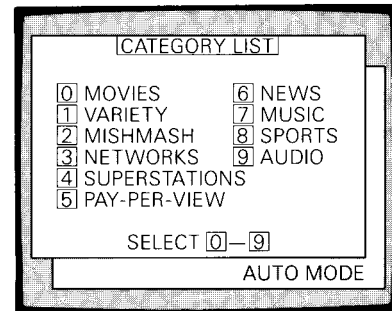

- (e) Select the desired category number and the program name list will be displayed.
Press **<** **>** to see the next or previous list.

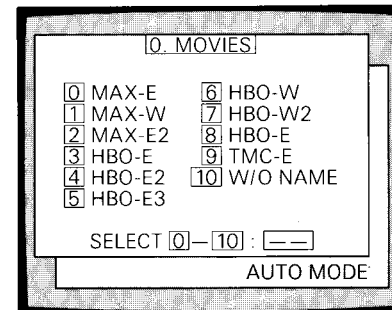

- (f) Select the desired program name to be stored.
If it is desired to store without a name, select 10 (w/o Name).

Note: When moving a program to a new satellite location, it is necessary to write the new location over the old one, as shown at right.

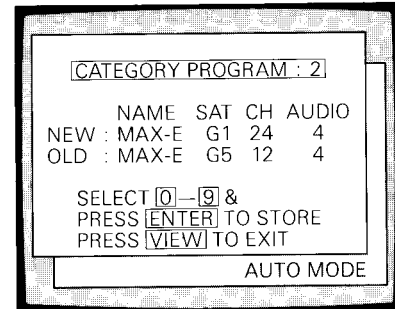

- (g) Select the desired program number. The pre-programmed data will be displayed as shown at right. Press [ENTER] to store the new location.
- (h) If unsure of which program number to store, press [CATEGORY]. The category program list will be displayed as shown at right. Press [<] [>] to see the next or previous list. Press [VIEW] to return.

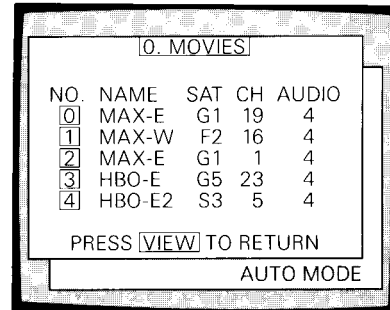

(2) TO CANCEL A PROGRAM

- (a) Set the receiver to the AUTO mode.
- (b) Press [FUNCTION], [3], [2] and the display will be as shown at right.

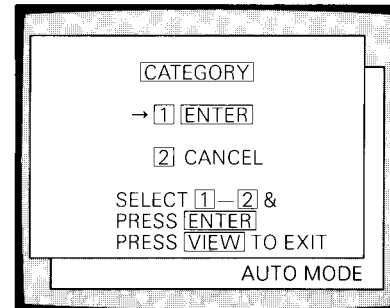

- (c) Select [2], [ENTER] and the category list will be displayed as shown at right.

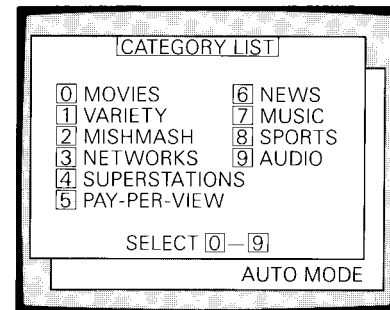

- (d) Select the category number and the pre-programmed list will be displayed as shown at right. Press [<] [>] to see the next or previous list.

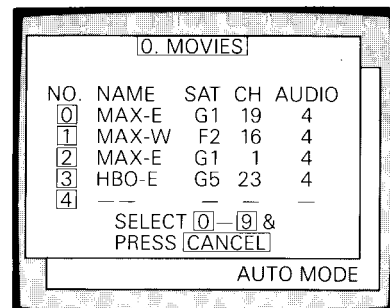

- (e) Select the program number to be cancelled and press [CANCEL] to delete the data.

FAVORITE CHANNELS

By using this function, it is possible to store up to 20 of your favorite satellite programs. It is then possible to select your desired program without selecting a satellite or channel. These programs may be on the same satellite or 20 different satellites. This feature is only available in the AUTO mode.

1. PROGRAMMING FAVORITE CHANNELS

- Set the receiver to the AUTO mode.
- Move the dish to the satellite and channel to be stored.
- Press **FUNCTION**, **3**, **3** and the display will be as shown at right.

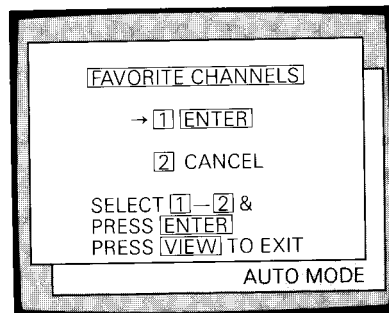

Select **1** and **ENTER**. The satellite and channel will be displayed as shown at right.

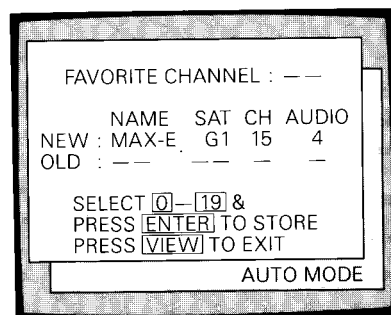

Input the FAVORITE CHANNEL number (0—19), which is to be stored and **ENTER**.

Note: When a program has moved to a new satellite location, it is necessary to program that change in the category selection menu before updating your FAVORITE CHANNEL list.

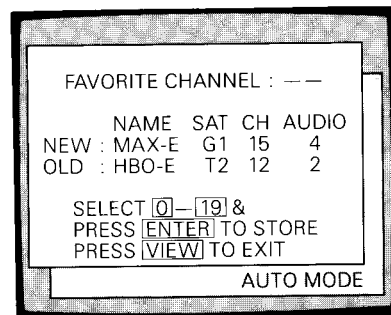

- If it is undecided which program number to store, press **FAVORITE**. Press **<** or **>** to see the next or previous FAVORITE CHANNEL list. Press **VIEW** to return.

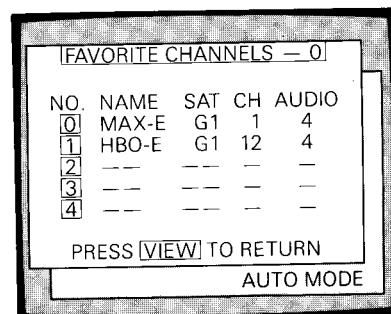

2. TO CANCEL A FAVORITE CHANNEL

- (a) Set the receiver to the AUTO mode.
- (b) Press **FUNCTION**, **3**, **3** and the display will be as shown at right.

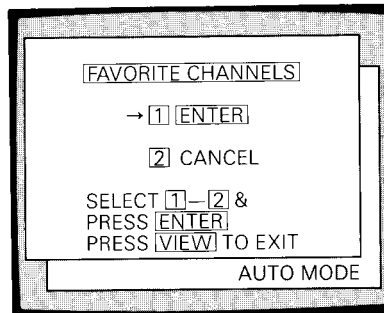

Select **2** and **ENTER**, the display will be as shown at right.

Press **<** or **>** to see the next or previous list.

- (c) Select the program number and press **CANCEL** to delete a FAVORITE CHANNEL.

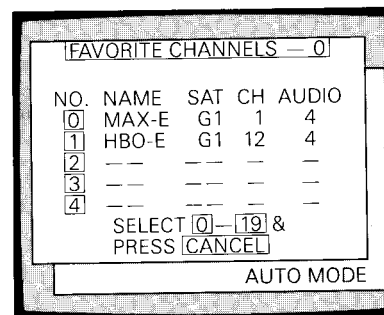

3. OPERATION OF A FAVORITE CHANNEL

Press **FAVORITE** twice and the FAVORITE CHANNEL list will be displayed. Press **<** or **>** to see the next or previous list. Enter the program number to select your FAVORITE CHANNEL.

Note: To select a FAVORITE CHANNEL directly without displaying the FAVORITE CHANNEL list, press **FAVORITE** and continue to enter the desired FAVORITE CHANNEL number.

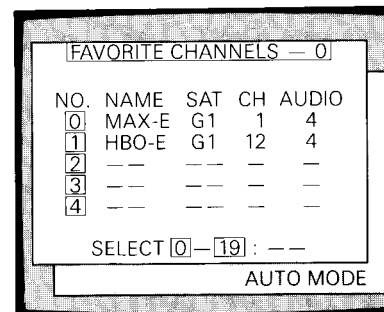

PARENTAL CONTROL

There are two features in PARENTAL CONTROL. One is antenna lock and the other is channel lockout. The password is needed to use this PARENTAL CONTROL feature. The factory preset password is 1048.

NOTE:

This function can be used only when receiver is in the AUTO mode. When PARENTAL CONTROL is on, the receiver can not be changed from AUTO to PROGRAM.

1. THE PARENTAL CONTROL PROGRAMMING

(a) Set the receiver to the AUTO mode.

(b) Press **FUNCTION**, **4** and the display will be as shown at right.

(c) Input the password and press **ENTER**. When the password is correct, the display will be as shown at right.

(d) Select the item number (1–4).

(e) The PARENTAL CONTROL items are as follows.

1. PARENTAL CONTROL (ON/OFF)

By pressing EAST **▼** or WEST **▲**, select ON or OFF.

2. ANTENNA LOCK PROGRAMMING

By pressing EAST **▼** or WEST **▲**, the antenna can be locked or unlocked.

3. CHANNEL LOCKOUT PROGRAMMING

When **3** is selected, the display will be changed as shown at right.

● Programming a channel lockout

Select the desired channel by pressing EAST **▼** or WEST **▲**.

Press **ENTER** and the channel is programmed to lockout. (An "L" will be displayed when selecting the other channel.)

Press **VIEW** and the previous on-screen display will be back.

● Canceling a channel lockout

By pressing EAST **▼** or WEST **▲**, select the channel that is locked out.

Press **CANCEL** and the channel will not be locked out.

Press **VIEW** and the previous on-screen display will be back.

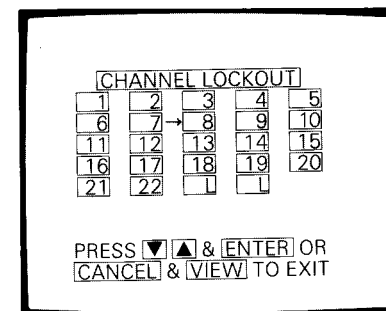
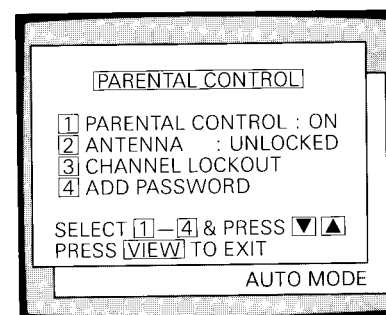
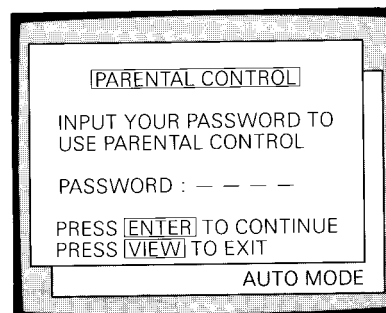

On the C-band satellite

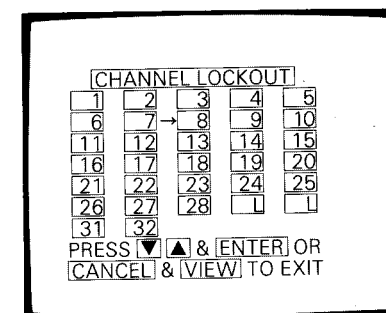

On the Ku-band satellite

4. ADD PASSWORD

When **4** is selected, the display will be as shown at right. Input the new password (4 digit) by using the ALPHANUMERIC buttons and press **ENTER** to store. The display will be back to the parental control menu.

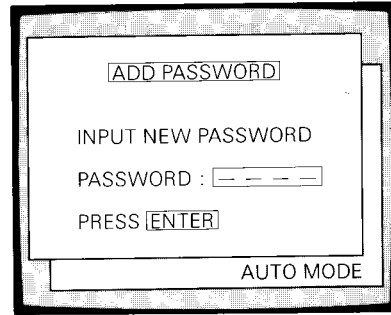

EX. When "1234" is entered as a new password, the display will be as shown at right.

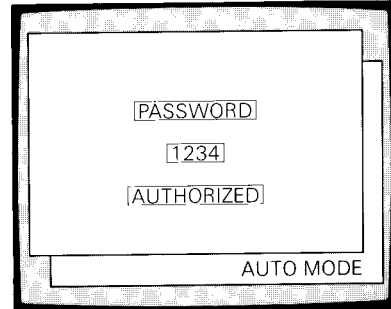

(f) Press **VIEW** to return to normal mode.

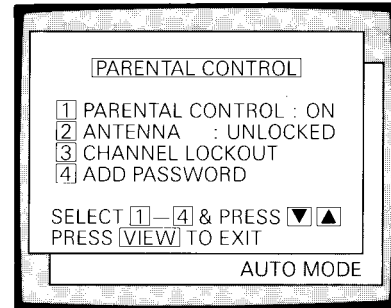

2. OPERATION OF THE PARENTAL CONTROL FEATURES

● When the antenna lock is on and EAST **▼** or WEST **▲** is pressed to try to move the antenna, or if a satellite ALPHANUMERIC designation is entered, the display will be as shown at right.

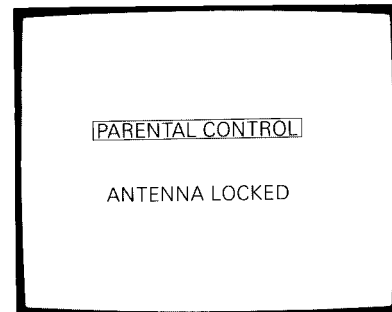

● When the channel lockout is on and a satellite channel is selected that is programmed to lockout, the display will be as shown at right.

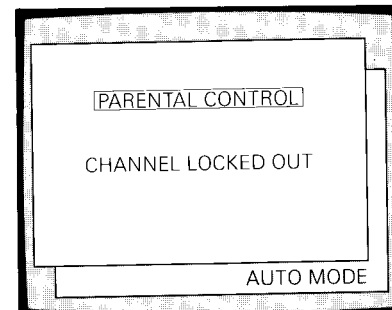

VIDEO FINE TUNING

By using this function, it is possible to reduce the sparkle noise in the picture. Only when the AFC (Auto Frequency Control) is off, can the video frequency be tuned. The video fine tune can be stored by channel.

(a) Press **FUNCTION**, **2**, **1** and the display will be as shown at right.

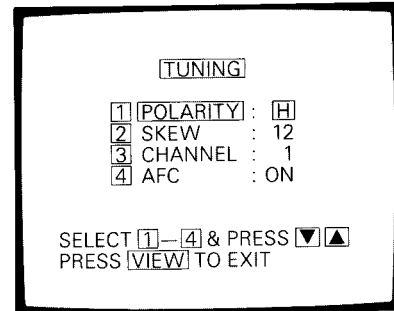

(b) Select 4.
By pressing EAST ▼ or WEST ▲, turn the AFC ON or OFF.

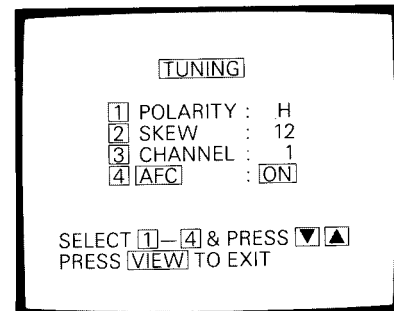

(c) The video frequency can be tuned only when the AFC is OFF. Select **5** and by pressing and holding EAST ▼ or WEST ▲, adjust the video frequency for the best picture. Press **VIEW** to return.

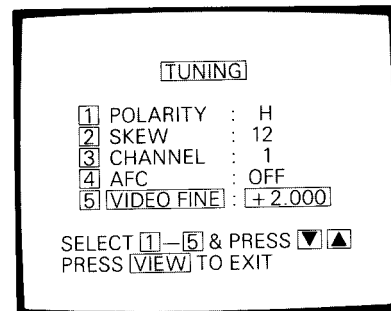

DESCRAMBLER OPERATION

Your new satellite system may contain a VideoCipher® Renewable Security (VideoCipher® RS, or VCRS) descrambler. With this descrambler, VideoCipher® scrambled channel can be enjoyed. This section describes how to use the descrambler.

I. GETTING STARTED

MODULE AUTHORIZATION

After your dealer has installed your new VCRS module, you or your dealer must follow the steps below.

1. Tune to a VideoCipher® scrambled channel. At this time the VideoCipher® signal LED should be illuminated on the receiver.
2. Press **SET UP** and **1** and **1**. The Unit ID will appear in two formats on the screen (shown below) in lines number 1 and 2. Please write the numbers down in the spaces provided.

Unit ID: -

Phone ID: - - - - - - - - - - - - - - - - - - - -

These lines contain your unique unit identification numbers (which will differ from those shown at right) and are used by your program providers to authorize you for subscription program reception.

3. The installation data will also show Signal Quality on line 8. This should read greater than 60. If this signal reads less than 60, you may experience difficulty authorizing the module. Adjusting dish alignment, receiver video fine tuning, and/or skew may help to increase the Signal Quality received by the module. Press **VIEW** to leave this screen and resume normal viewing.

• INSTALLATION DATA •	
VideoCipher RS Descrambler	
1) Unit ID:	0400-3057-FF4E
2) Phone ID:	0100-0060-2577-7516
3)	
4) Version:	Module 1.0
5) IRD S:	Subscribed
6) VIDEOpal	not enabled
7) Provider ID	153
8) Signal Quality	100
9) Trip Counter	1
10) Message Rate	10
11) Category	CO-4F
12) Location	Set
(Press VIEW to exit)	

SUBSCRIPTION SERVICES TRANSFER: NEW OR EXISTING

4. Call the programmer(s) who provided subscription services on the old module (their telephone numbers are included with the new module for your convenience). This is necessary to transfer your subscription programs to your new module. Programmers may ask for the Unit ID that appeared on your most recent billing statement(s), or on the back of the older module. Your Programmers will also require the ID numbers noted in item 2 above. These numbers are also used for all new subscription purchases.

NOTE: The unit ID is sometimes referred to as the Unit Address, or UA.

5. After initiating or transferring services, leave the receiver tuned to a VideoCipher® scrambled channel until the module receives authorization and you are able to view the programs you ordered. If you view the Setup 1,1 screen again, you will notice that your trip counter number has increased.

DESCRAMBLER OPERATION

OPERATIONS: ON-SCREEN DISPLAYS AND DESCRIPTIONS

Once your module has received subscription authorization, you may want to take the time to become familiar with the many different features, capabilities, and on-screen displays (OSDs) that your VCRS module can produce and what purposes they serve. Your on-screen displays allow you to: 1) see how well your system is functioning on VideoCipher® channels; 2) receive important messages from your programmer; 3) limit access to programs with mature subject materials; or 4) use the Instant Pay-Per-View features of your module.

NOTE: These on-screen displays are visible only on VideoCipher® channels.

THE SETUP SCREEN

Available Services Menu

The first screen you see after you press **SET UP** is "Available Services Menu". This menu simply allows you to choose the next screen you want to see from four available choices. If you wish to return to normal television viewing at any time, press **VIEW**.

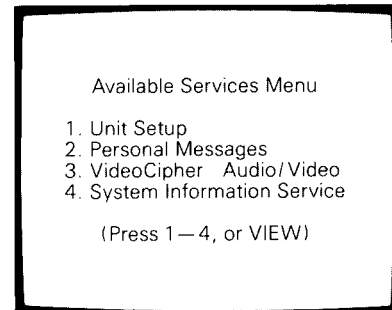

THE SETUP AND 1 SCREEN

VideoCipher® Unit Setup

Pressing **SET UP** and **1** will allow you to view the VideoCipher® Unit Setup screen. This screen contains eight different choices. Choices 1 through 4 are used for normal operation of the module, while choices 5 through 8 relate to instant pay-per-view operation. Press **VIEW** to leave this screen and resume normal viewing.

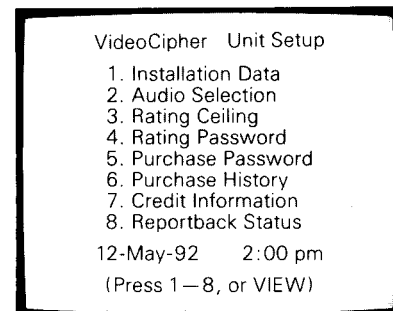

SETUP 2

Personal Messages

Pressing **SET UP** and **2** or the message key will allow you to view the Personal Messages screen. Unless your programmer has sent you a message, this screen will read "No Personal Messages". Press **HELP** for additional information on the Personal Messages screen. Press **VIEW** to leave this screen and return normal viewing.

NOTE: Your VCRS module cannot be disabled from receiving messages. Read messages (to remove the blinking message indicator) by pushing the **MESSAGE** key. Press **VIEW** to leave this screen and resume normal viewing.

SETUP 3

VideoCipher® Audio/Video

Pressing **SET UP** and **3** will allow you to view the programming currently offered on the VideoCipher® channel that you have selected. Selecting **VIEW** is the same as pressing **SET UP**, **3**.

SETUP 4

System Information Service

Pressing **SET UP** and **4** will allow you to view the Systems Information Services screen. This screen is intended for broadcast text messages and will be headed by the title VideoCipher® Text Service. This text service is broadcast at the programmer's option and may not be available on many channels. Press **HELP** for further information on the Systems Information Services screen. Press **VIEW** to leave this screen and return to normal viewing.

OTHER MODULE FUNCTIONS

In addition to the **SET UP** key functions, your VCRS module also offers some other key functions. They are listed below:

HELP

This key provides any additional information available for the screen you are viewing.

MESSAGE

This key allows you to view any personal messages you may have.

NEXT

This key allows you to see information about the next program being broadcast on the channel you are viewing. This information is transmitted at the programmer's option.

VIEW

This key allows you to see information about the current program. This may include the program name and how much time is left in the program. In addition, it returns you to normal viewing from any other on-screen display. The information displayed disappears after 5 seconds if the key is not pressed again.

NOTE: Not all programmers broadcast **VIEW** or **NEXT PRG** information.

The VideoCipher® Unit Setup screen contains many important diagnostic items. Let's review them one at a time.

THE SETUP 1 AND 1 SCREEN

Checking The Unit Status

When you press **SET UP**, **1** and **1** you will see the Installation Data screen. This screen provides information about unit and system operation. Press **HELP** for additional information on the Installation Data screen. Press **VIEW** to leave this screen and continue normal viewing, or press **ENTER** to return to the Setup menu.

```

• INSTALLATION DATA •
VideoCipher RS Descrambler
1) Unit ID: 0400-3057-FF4E
2) Phone ID: 0100-0060-2577-7516
3)
4) Version: Module 1.0
5) IRD S: Subscribed
6) VIDEOpal not enabled
7) Provider ID 153
8) Signal Quality 100
9) Trip Counter 1
10) Message Rate 10
11) Category CO-4F
12) Location Set
(Press VIEW to exit)
    
```

DESCRAMBLER OPERATION

Lines 1 and 2 contain your unique unit identification number, used by the programmer to authorize you for subscription programming.

Line 3 will be blank unless the VideoCipher® RS replaceable security element, the TvPass Card, is installed. It will then display a TvPass Card ID number.

NOTE: The TvPass Card is not included in this initial shipment of the VCRS module.

Line 4 tells you what version of module and TvPass Card is in your system.

NOTE: The numbers shown on your screen may be different than the ones shown above. The TvPass Card version will only show up if one is installed.

Line 5 tells you the scrambling status of the VideoCipher® channel to which you are currently tuned. Refer to the table below for possible displays.

<u>MODEL TYPE</u>	<u>SCRAMBLING STATUS</u>	<u>AUTHORIZATION STATUS</u>
DES = Module inserted into a standalone descrambler	F = Fixed Key	Subscribed
IRD = Module inserted into an integrated receiver descrambler	P = Processed, Unscrambled	Purchased
	S = Scrambled	Not Subscribed

Line 6 shows if your new module has been authorized for instant pay-per-view operation. This line will read, "VIDEOpal enabled" if the module is authorized for instant pay-per-view (see page 34 of this manual to authorize your built-in VIDEOpal Order Recorder).

Line 7 contains the unique Programmer ID code for each channel.

Line 8 is your Signal Quality. The maximum Signal Quality is 100. As noted earlier in the Authorization-section of this manual, if this number is less than 60, you may have difficulty authorizing the module and your satellite system is possibly in need of tuning or maintenance to operate properly.

Line 9 shows how many authorization change requests your module has received since you turned to this screen.

Line 10 shows if your module is receiving a clear signal from your satellite dish. The clearest signal will be a 10.

Line 11 shows if your system has received its monthly authorization update from the programmer. These numbers should be the same on all working descramblers, and will change on a monthly basis. Your programmer may ask about these characters should you have trouble gaining access to programming.

Line 12 shows that the programmer has your unit identification number stored properly, enabling you to receive the programming you have ordered.

THE SETUP 1 AND 2 SCREEN

Checking The Unit Settings

When you press **SET UP**, **1** and **2** you will see the Audio Selection screen.

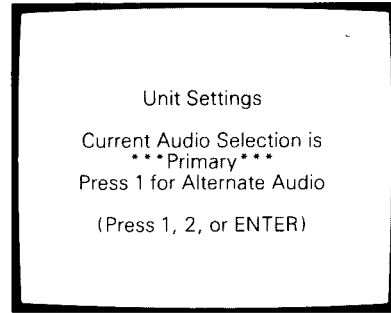

Current Audio Selection

This feature allows setting the audio on scrambled channels to either *****Primary***** or *****Alternate*****. The normal setting will be *****Primary*****. Scrambled channels may or may not broadcast an *****Alternate***** audio feed. Pressing **1** will change the module setting to *****Alternate*****. (Alternate could be a second language transmission.) Press **VIEW** at any time to resume normal viewing.

THE SETUP 1 AND 3 SCREEN

Setting The Rating Ceiling

Press **SET UP**, **1** and **3** reveals the Set Rating Ceiling screen. For example, if you set your Rating Ceiling at "PG-13", your module will require a password (if one has been set) before allowing viewing access of any movies with "R" or "X" ratings. You cannot, however, lockout shows with a "G" rating or non-rating, "NR". Refer to the guide below for a complete list of movies ratings.

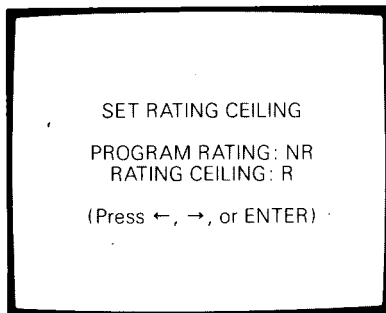

MOVIE RATINGS GUIDE

- NONE** — No Rating
- G** — General Audiences
- PG** — Parental Guidance Suggested
- PG13** — Parental Guidance for Children Under 13
- R** — Restricted
- NR** — Not Rated; Used for Non-Rated Adult Programming
- NC17** — No Children 17 or Under
- X** — Adult, No One Under 18

ADVANCED OPERATION

The Program Rating line shows the rating the current program carries. An "NR" on this line indicates the program being viewed is not rated by the Motion Picture Association of America (MPAA). The Rating Ceiling line indicates the highest rating the module will allow to be viewed. To set the level, press the left or right arrow keys until the rating ceiling reaches the desired level. If you wish to insure that no programs are locked out due to Rating Ceiling, this setting should remain at "X". Remember, you must press **ENTER** to save the changes and it is advisable to set a password, as described below, to enforce this rating level. Press **HELP** for additional information on the Set Rating Ceiling screen. Press **VIEW** to return to normal viewing.

DESCRAMBLER OPERATION

THE SETUP 1 AND 4 SCREEN

Setting A Rating Password

Pressing **SET UP**, **1** and **4** allows you to establish a Rating Password. This screen will allow putting a password into place so that the Rating Ceiling can only be changed by you.

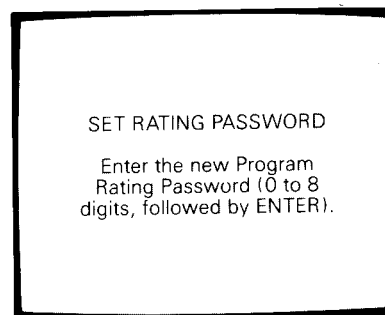

To Set A Rating Password

Choose an easy to remember number (a birth date, etc.). Enter up to 8 characters (the screen will show one * for each number pressed) and press **ENTER**. The module will ask you to enter your password again for confirmation. Enter the same numbers, followed by **ENTER**. Your new Rating Ceiling Password will be stored. If you make a mistake, use the left arrow key to erase the entry. If you decide to change your Rating Ceiling (**SET UP** **1** and **3**), the module will ask you to enter the existing Rating Password. After the password has been entered, you can change your Rating Ceiling as described above. Press **HELP** for further information on the Set Rating Password screen. Press **VIEW** to leave this screen and resume normal viewing.

To Remove A Rating Password

Press **SET UP**, **1** and **4** to re-enter the Password screen. Next, enter the existing password, then press **ENTER**. Now, press **ENTER** two more times to remove your Rating Ceiling Password. If you want to set a new password, follow the instructions above. Press **VIEW** to resume normal viewing.

THE TvPass Card

In the event of a change in Programmers' authorization levels, programmers may decide to utilize the card authorization feature of the VCRS module. This feature consists of a TvPass Card, which is a plastic "smart card", about the size of an average credit card. This card will fit into the slot provided in the rear of the module, at the back of IRD.

If a TvPass Card is in use with this VCRS module, you will need to be aware of some additional OSDs. These OSDs are designed to inform you of satellite system problems relating to the installation and use of the TvPass Card. These displays will appear automatically on all VideoCipher® Channels in the event of a problem with your TvPass Card.

NOTE: These displays cannot be seen unless the TvPass Card system is in use and you are tuned to a VideoCipher® channel. The TvPass Card is not included in this initial shipment of the VCRS module.

CONDITION

EXPLANATION/ACTION

TvPass Card Not Installed

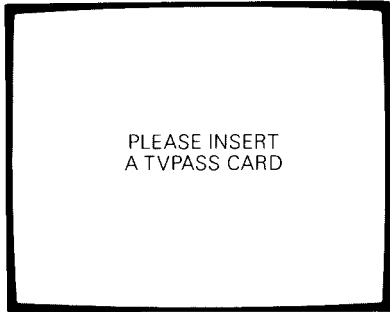

System authorization has been upgraded to a higher level, which now requires a TvPass Card.

1. Insert your TvPass Card into the VCRS descrambler via the opening in the back of the module.
2. If this screen appears and you do not have a TvPass Card, contact your program provider.

TvPass Card Installation Error

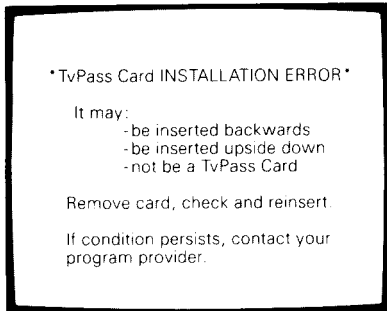

The TvPass Card you are attempting to install is not working properly. Please make sure that its orientation is correct. Only General Instrument TvPass Cards will work in this VCRS descrambler. Contact your program provider if this problem persists.

TvPass Card Needs Information

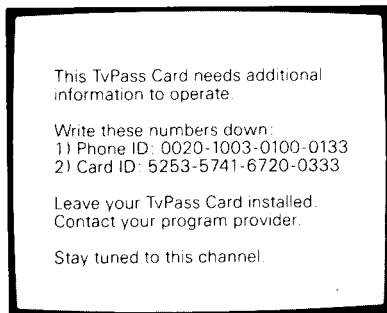

This TvPass Card needs additional information to operate. Write down the numbers appearing on your screen, leave your TvPass Card installed, stay tuned to this channel, and contact your program provider.

Phone ID:

Card ID:

Descrambler Not Authorized

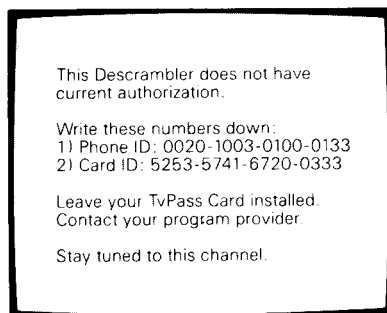

This descrambler is not currently authorized. Write down the numbers appearing on your screen, leave your TvPass Card installed, stay tuned to this channel, and contact your program provider.

Phone ID:

Card ID:

ADVANCED OPERATION

DESCRAMBLER OPERATION

Wrong TvPass Card In Descrambler

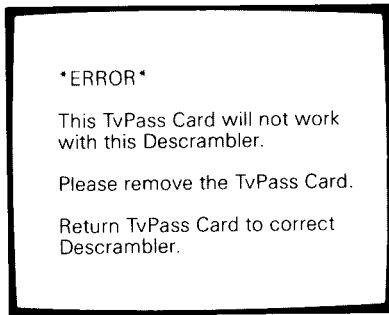

This TvPass Card was authorized in a different VCRS-equipped IRD, and cannot be moved to this VCRS descrambler. You must return it to the original unit.

II. INSTANT PAY-PER-VIEW

THE WORLD OF VIDEOPAL® INSTANT PAY-PER-VIEW

The VIDEOpal Order Recorder is a breakthrough in home satellite viewing. It provides your system with instant pay-per-view at the touch of a button! With it, you'll enjoy many special programs and events once available only to cable subscribers or on videotape. The benefits of the VIDEOpal system are many.

INSTALLATION INFORMATION

FCC-Required Notification

Type Of Service

The built-in VIDEOpal system in the VCRS module is designed to be used on standard telephone lines and connects to the telephone line by means of a standard jack called the USOC RJ11C. Connection to telephone company-provided coin service (central office implemented systems) is prohibited.

Telephone Company Procedures

In order for your telephone company to provide you service, it may occasionally be necessary for them to make changes in their equipment, operations, or procedures. If these changes affect your service or the operation of your equipment, the telephone company should give you notice, in writing, to allow you to make any changes necessary to maintain uninterrupted service. If you have any questions about your telephone line, such as how many pieces of equipment you can connect to it, your telephone company should provide this information upon request. In certain circumstances, it may be necessary for your telephone company to request information from you concerning the equipment which you have connected to your telephone line. Upon request of your telephone company, provide the FCC registration number and the Ringer Equivalence Number (REN) of the equipment which is connected to your line: both of these items are listed on the equipment label. The sum of all the RENs on your telephone lines should be less than five in order to assure proper service from your telephone company. In some cases, a sum of five may not be usable on a given line.

NOTE: The REN for your built-in VIDEOpal system in the VCRS module is 0.3B.

If Problems Arise

If any of your telephone equipment is not operating properly, you should immediately remove it from your telephone line, as it may cause harm to the telephone network. If your telephone company notes a problem, they may temporarily discontinue service. When practical, they will notify you in advance of this disconnection. If advance notice is not feasible, you should be notified as soon as possible. When you are notified, you should be given the opportunity to correct the problem and be informed of your right to file a complaint with the FCC.

NOTE: The VIDEOpal Order Recorder will not work properly at this time if you are on a party line or if operator assistance is required to make long distance telephone calls

NOTICE FOR CANADIAN USERS

The Canadian Department of Communications label identifies certified equipment. This certification means that the equipment meets certain telecommunications network protective operational and safety requirements. The Department does not guarantee the equipment will operate to the user's satisfaction. Before installing this equipment, users should ensure that it is permissible to be connected to the facilities of the local telecommunications company. The equipment must also be installed using an acceptable method of connection. In some cases, the company's inside wiring associated with a single line individual service may be extended by means of a certified connector assembly (telephone extension cord). The customer should be aware that compliance with the above conditions may not prevent degradation of service in some situations.

Repairs to certified equipment should be made by an authorized Canadian maintenance facility designated by the supplier. Any repairs or alterations made by the user to this equipment, or equipment malfunctions, may give the telecommunications company cause to request the user to disconnect the equipment. Users should ensure, for their own protection, that the electrical ground connections of the power utility, telephone lines, and internal metallic water pipe system (if present) are connected together. This precaution may be particularly important in rural areas.

CAUTION: Users should not attempt to make such connections themselves, but should contact the appropriate electric inspection authority, or electrician.

The Load Number for the VCRS with the internal VIDEOpal system is 7.

The Load Number (LN) assigned to each terminal device denotes the percentage of the total load to be connected to a telephone loop which is used by the device to prevent overloading. The termination on a loop may consist of any combination of devices subject only to the requirement that the total of the load numbers of all the devices does not exceed 100.

PAY-PER-VIEW AUTHORIZATION WITH THE SATELLITE VIDEO CENTER

To authorize your VCRS module for pay-per-view programming, please follow these simple steps:

1. Ensure proper connection of the module to the telephone system as explained in the installation instructions. It is necessary for the module to be connected to a live telephone line for pay-per-view authorization. It is suggested that you test this line by connecting a telephone to this line and placing a call. Be sure to reconnect the telephone line to the module before proceeding with authorization.

2. Tune to a VideoCipher® scrambled channel and verify proper signal strength. Press **SET UP**, **1** and **1** to verify. The signal strength that appears on line 8 should read greater than 60. If this signal reads less than 60, you may experience difficulty authorizing the module. Adjusting dish alignment, receiver tuning, and/or skew may help to increase the module Signal Quality.

* INSTALLATION DATA *	
VideoCipher RS Descrambler	
1) Unit ID:	0400-3057-FF4E
2) Phone ID:	0100-0060-2577-7516
3)	
4) Version:	Module 1.0
5) IRD S:	Subscribed
6) VIDEOpal not enabled	
7) Provider ID	153
8) Signal Quality	100
9) Trip Counter	1
10) Message Rate	10
11) Category	CO-4F
12) Location	Set
(Press VIEW to exit)	

3. Call your pay-per-view program provider or the Satellite Video Center at 800-54-VIDEO (800-548-4336). A Customer Service Representative will assist you in setting up an account to purchase pay-per-view. The module is authorized for pay-per-view when Line 6 reads "VIDEOpal enabled".

DESCRAMBLER OPERATION

ON-SCREEN DISPLAYS AND DESCRIPTIONS FOR PAY-PER-VIEW

THE SETUP 1 AND 5 SCREEN

Setting/changing Purchase Passwords

1. Press **SET UP**, **1** and **5** to establish a purchase password. This screen allows you to limit access to pay-per-view programming, by setting a security password for use with the module's internal VIDEOpal Order Recorder. For example, you may wish to prevent purchases by children or babysitters in your home. This feature is for customer convenience, but is not required to operate the instant pay-per-view feature. It is, however, strongly suggested that a password be used in order to prevent unauthorized pay-per-view purchases. Press **HELP** for further information on the Purchase Password screen. Press **VIEW** to leave this screen and resume normal viewing.



2. There are two types of passwords with this product. You may have already set a Rating Password, now you are going to set a Purchase Password. Choose an easy to remember number (such as an anniversary, etc.). Enter up to 8 characters (the screen will show one * for each number pressed) and then press **ENTER**. For confirmation, the module will ask you to enter your new password again. Enter the same numbers, followed by the **ENTER** key. Your new Purchase Password will be stored. If you then wish to make a purchase, you will be asked to enter the Purchase Password. Enter it as instructed above and you will be allowed to complete your purchase.

To Change A Purchase Password

Follow these simple steps:

1. Press the **SET UP**, **1** and **5** keys on the remote control and follow the directions on your screen.

Removing A Password

Press **SET UP**, **1** and **5** to re-enter the Password screen. Next, enter the existing password, then press **ENTER**. Now, press **ENTER** two more times to remove your Purchase Password. If you want to set a new password, follow the instructions at the top of this page. Press **VIEW** to resume normal viewing.

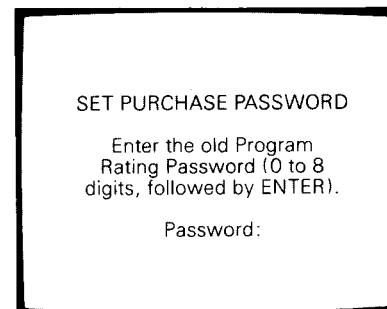

NOTE: If you should forget your password, it may be necessary to call your pay-per-view program provider or the Satellite Video Center at 800-54-VIDEO. They will remove the forgotten password via satellite. This will reset the Purchase Password and the Rating Password, making it necessary to reset both. There may be a charge for a password reset.

THE SETUP 1 AND 6 SCREEN

Purchase History

Pressing the **SET UP**, **1** and **6** buttons will allow you to view the Purchase History screen. This screen will allow you to review the 16 most recent programs purchased with your instant pay-per-view feature. Use the left and right arrow keys on your remote control to see all 16 purchases. Press **HELP** for additional information on the Purchase History screen. Press **VIEW** to leave this screen and resume normal viewing. (If you have no purchase history, you will only view the Unit Setup screen.)

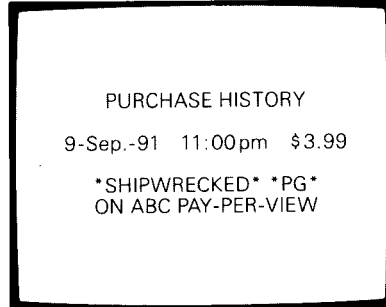

THE SETUP 1 AND 7 SCREEN

Credit Information

Pressing **SET UP**, **1** and **7** will allow you to view the Credit Information screen. The Satellite Video Center (or another authorization center) may ask you to read this screen if the unit's instant pay-per-view services are interrupted. The credit amount shown at the top of the screen does not represent dollars credited to the unit account—it is for administrative purposes only. The last line indicates whether or not you have established an account to purchase programs with the Satellite Video Center. Press **HELP** for additional information on the Credit Information screen. Press **VIEW** to leave this screen and resume normal viewing. You will not be able to access this screen if you have not established VIDEOpal services.

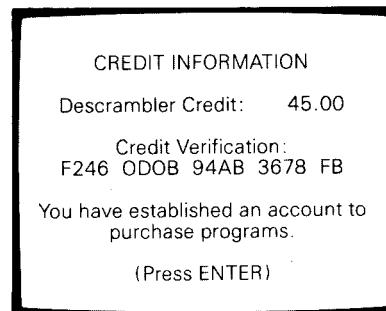

THE SETUP 1 AND 8 SCREEN

Reportback Status

Pressing **SET UP**, **1** and **8** will allow you to view the Reportback Status screen. Periodically, the VIDEOpal Order Recorder will report through a toll-free (800) number, any instant pay-per-view purchases that have been made. This screen will display whether or not the last reportback attempt was successful. The screen should always read SUCCESSFUL. If this screen reads anything else, please check the telephone cable connection on the rear of the module and contact the Satellite Video Center at 800-54-VIDEO. Press **HELP** for additional information on the Reportback Status screen. Press **VIEW** to leave this screen and resume normal viewing.

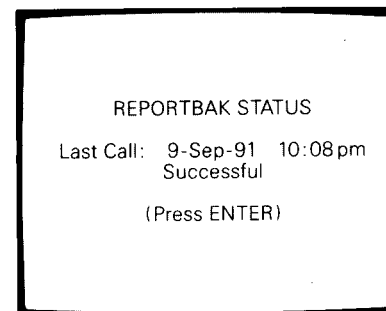

ADVANCED OPERATION

DESCRAMBLER OPERATION

Instant Pay-Per-View Operation

Once authorized by the Satellite Video Center, your module provides you with the ability to purchase pay-per-view services on satellite. Simply consult your program listings for available program services and follow the instructions below to enjoy VCRS pay-per-view programming.

Satellite Video Center Pay-Per-View Programs

The VIDEOpal built into the module allows purchase of the current program being offered on pay-per-view channels or the program coming up next after the current program ends.

Purchasing The Current Program

1. Tune the satellite receiver to the satellite and transponder (channel) of the pay-per-view program you wish to purchase. For a complete listing of pay-per-view movies and events, check your satellite program guide.
2. Press **VIEW** for purchasing information. This screen will display the name of the program, the amount of time remaining in the program (if it has already started), and the price of the program.
3. To order the program, press the **ENTER** key, enter the password (if there is one), then press **ENTER** again to confirm the order. *That's all it takes!*

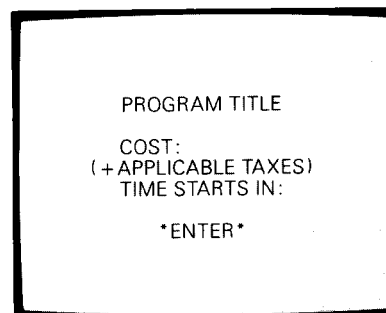

Current Program Screen

NOTE: Pay special attention to the time the program ends. Your account will be billed for the full program price regardless of how much of the program has elapsed before you order. Also, Rating Ceiling lockout applies prior to confirmation of purchase, if active.

NOTE: All programmers have the ability to prevent a late program purchase after some portion of the program has already elapsed. For example, if you should accidentally try to purchase a program after it has passed the halfway mark, you may see a message stating that you cannot purchase this program. This lockout feature, called the Purchase Window, is optional with each programmer who may or may not decide to use it.

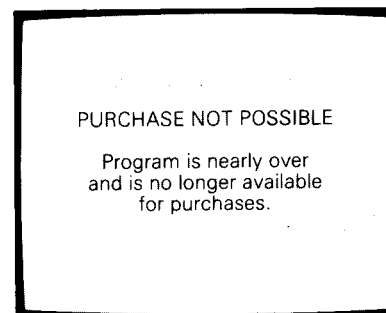

Purchase Window Screen

Purchasing The Next Program

1. To order the next program, tune the satellite receiver or IRD to the correct satellite and transponder (channel) and press **NEXT PRG**. The screen will display information on the program title, cost, and the amount of time remaining before the next program begins. You may also consult a satellite guide for program availability.

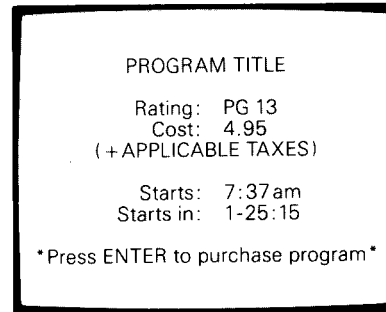

Next Program Screen

2. The screen will prompt you to press **ENTER** to purchase the next program. Press **ENTER** if you wish to order the program, enter the purchase password (if there is one), and then press **ENTER** again to confirm the order. Keep your IRD turned on and wait for the start of the next program. You may buy only one show in advance.

IMPORTANT: Cancelling The Program After Ordered

It is possible to cancel the NEXT program once it has been ordered. Should you decide not to view the program coming up next, simply change the channel. Or, you may also press **NEXT PRG** and then **ENTER** at the "press ENTER to CANCEL" prompt before the program begins. Your account will not be billed for the purchase of the program if it is cancelled before it begins. It is not possible, however, to cancel the current program once it has been purchased and the program has begun.

Note: VIDEOCIPHER® RS is a registered trademark of GENERAL INSTRUMENT CORPORATION.

TvPass™ Card is a trademark of GENERAL INSTRUMENT CORPORATION.

VIDEOCIPHER® RS trademark is used under license from CABLE/HOME COMMUNICATIONS CORP. (C/HCC), subsidiary of GENERAL INSTRUMENT CORPORATION.

To enable your satellite descrambler and obtain proper authorization for descrambling, appropriate programming providers or their agents must be contacted.

DESCRAMBLER OPERATION

VIDEOPAL® QUESTIONS AND ANSWERS

Q) What happens if the phone line to the VCRS system is accidentally unplugged?

A) If the unit should be disconnected from your home telephone system your pay-per-view programming services may be interrupted. If your service is discontinued, you must call the billing center or the Satellite Video Center for re-authorization.

Q) Will the VIDEOpal system interfere with my phone service?

A) Usually not. The VIDEOpal system is called upon to use your phone line when you are least likely to be using it. If you should pick up your receiver and hear a very unusual noise, it may be the VIDEOpal unit communicating with the Satellite Video Center's (or billing center's) computer at the other end. Please hang up and try your call again.

Q) Do I have to pay for the phone call?

A) The VIDEOpal Order Recorder calls in on a special toll-free (800) number so you shouldn't see the call on your monthly phone bill.

Q) How long do the calls last?

A) Typically, they last less than 15 seconds and they are usually made late at night when you are least likely to be using your telephone.

Q) Will the VIDEOpal system interfere with my telephone answering service or answering machine?

A) The VIDEOpal module is not equipped to receive phone calls, only make them. If your service or answering machine is not currently disturbed by outgoing calls, the VIDEOpal system should not cause any problems.

Q) I'm on a party line. What happens if my VIDEOpal unit tries to make a call and someone else is on the line?

A) The VIDEOpal will not work with party lines, or if you require an operator's assistance to make long distance calls.

Q) I have call forwarding / call waiting. Will the VIDEOpal system have any affect on it?

A) The VIDEOpal features should not have any affect on these services.

Q) I sometimes unplug my phone at night. Will that affect the VIDEOpal system's ability to call out?

A) It is all right to unplug your phone, however, be certain to unplug it rather than leave the receiver off the hook. Leave the VIDEOpal unit plugged into the phone line at all times.

Q) What if I should happen to forget my password?

A) If you should forget your password, it will be necessary to call the Satellite Video Center (or your billing center). They will remove the password for you, along with any other VCRS passwords. (There may be a service charge for this.) You may then enter a new password if you wish. **NOTE:** The VIDEOpal password may be the same as your VCRS password.

Q) What if I should change channels while the event is taking place, and then tune back to the same channel? Will I be charged twice for the same program?

A) No. To clarify, you will not be charged again when returning to a purchased program, even if you purchased a second program before returning to the original.

Q) What if I purchase the NEXT program, but then don't watch it?

A) Your account won't be charged for any programming you order in advance if your receiver is tuned to a different channel before the next program starts.

Q) How far in advance may I order a program?

A) You may order only the program in progress or the next program available.

Q) My telephone sometimes chirps when the VIDEOpal Order Recorder is making a phone call. Is this normal?

A) There are two basic types of phone service your phone company may offer: Rotary/Pulse (mechanical dial) and Tone (push button). Many electronic push button telephones will work with Rotary/Pulse service by using the Pulse dialing method (after pressing the telephone's buttons you will hear a clicking sound in the receiver.) The VIDEOpal Order Recorder operates in the same manner as a Pulse telephone and may cause some telephones to chirp briefly when it makes a call. This will not interfere with your telephone service or your telephone.

Q) I cannot receive the channel. What do I do?

A) Operation of the VIDEOpal system is almost totally automatic and there are no adjustments necessary. If you should ever experience any difficulty using the VIDEOpal system, please refer to the following troubleshooting suggestions:

- 1) Check all connections and make sure that the power is ON to all components.
- 2) Make certain that your satellite system is tuned to the correct satellite and channel. **NOTE:** Weather conditions and your geographical location may affect signal quality.
- 3) Check a program guide to make certain that the program you're interested in is available for pay-per-view and can be ordered with the VIDEOpal system.
- 4) Make certain your account is current (press **SET UP**, **1**, **7** for possible on-screen directions.)

ATTENTION:

This consumer unit is intended for the authorized descrambling for personal use of those satellite television signals which have been scrambled using the VIDEOCIPHER® II or VIDEOCIPHER® II Plus scrambling format. Ownership or possession of the descrambler does not entitle (not enable) the owner or possessor thereof to receive descrambled VIDEOCIPHER® II or VIDEOCIPHER® II Plus television signals. To obtain proper authorization for this consumer descrambler, the owner or possessor must separately contract with the appropriate programming provider(s) or this (their) agent(s).

U.S. government restrictions may prohibit the export of this product outside the United States, its territories, or possessions without a valid export license.

MAIN FUNCTIONS

— PROGRAM MODE —

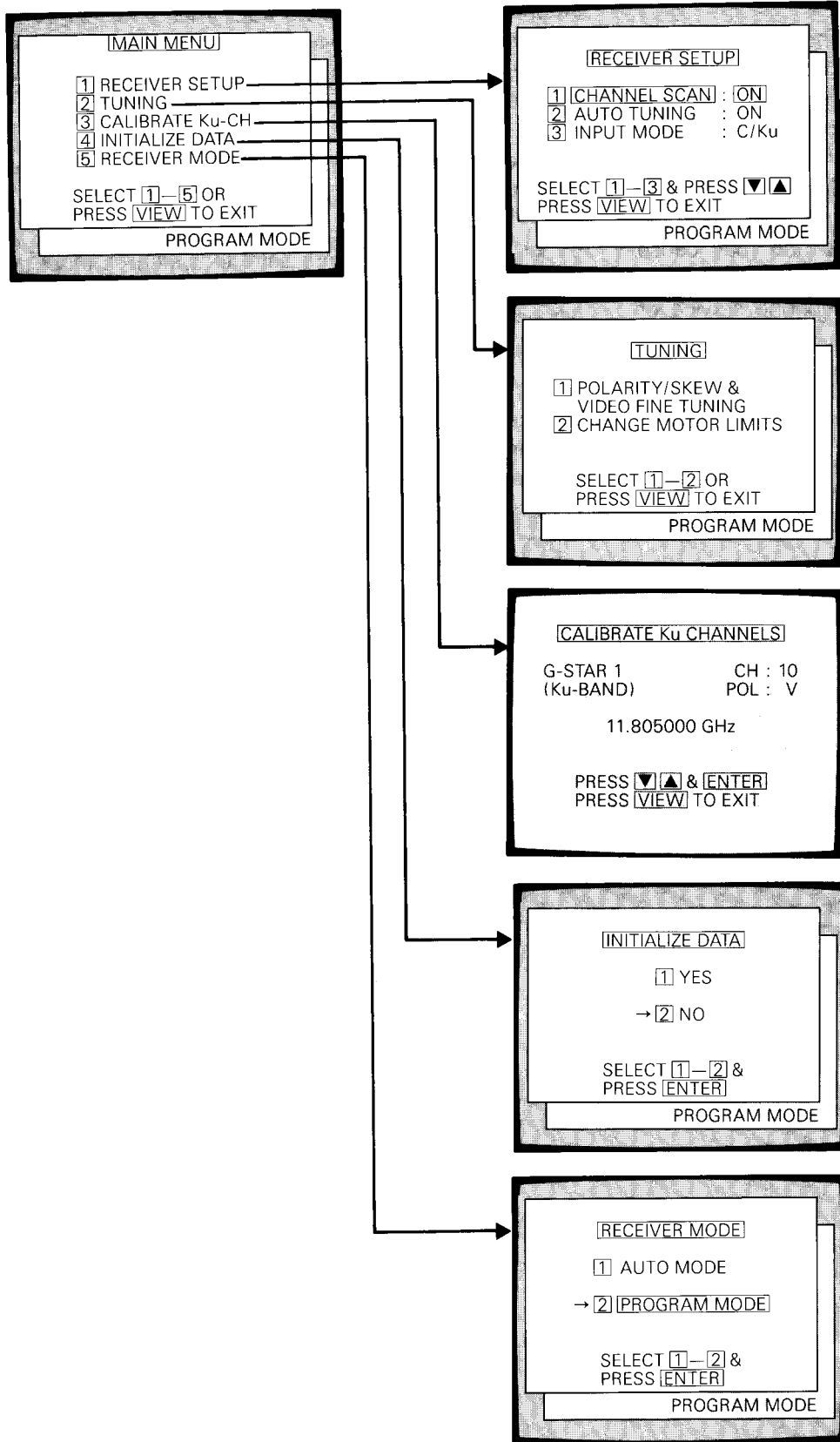

—AUTO MODE—

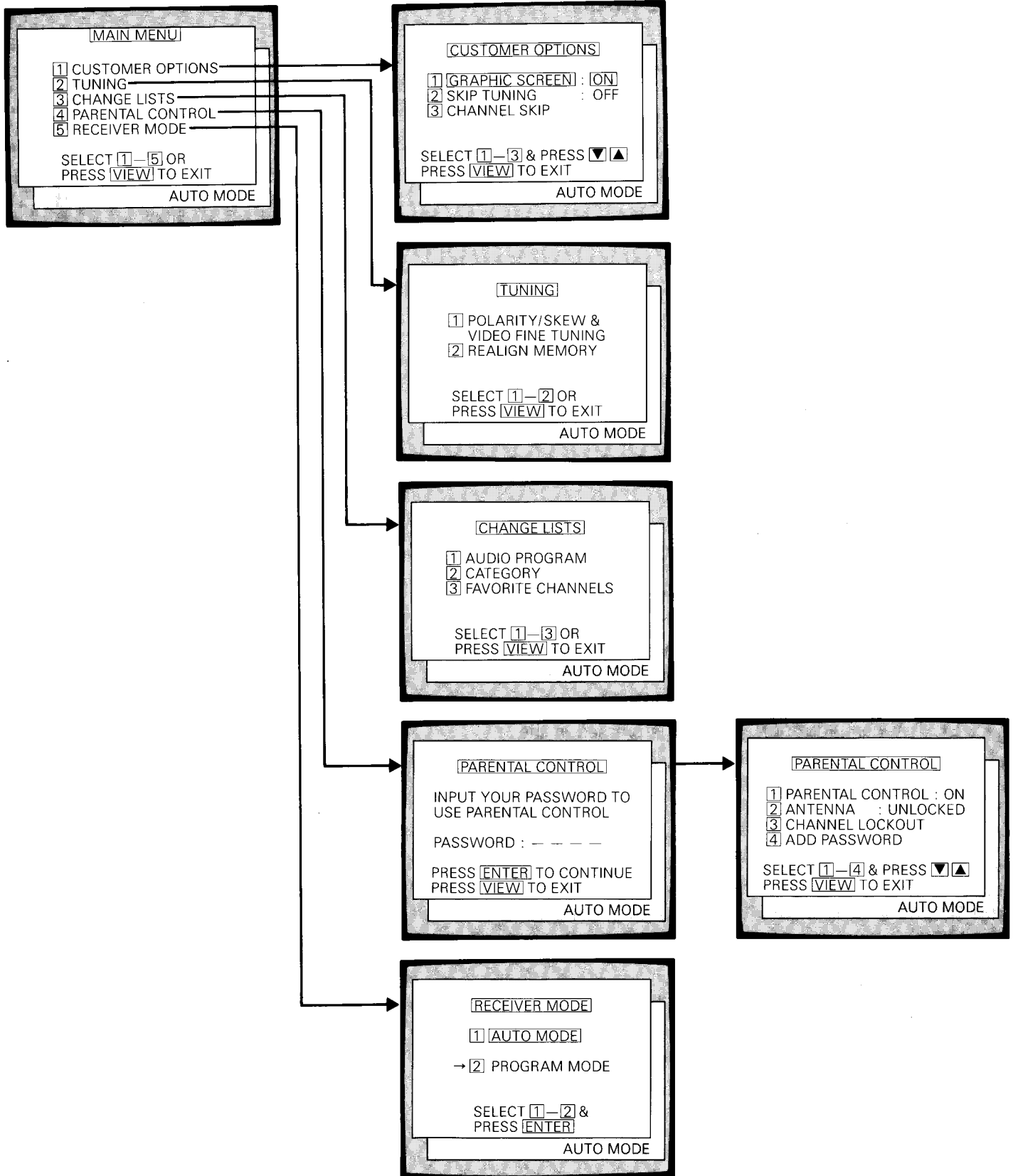

ADVANCED OPERATION

MAIN FUNCTIONS

These functions can be easily used with **FUNCTION** and an ALPHANUMERIC BUTTON as follows.

1. BASIC OPERATION OF THE MAIN FUNCTIONS

(a) Press **FUNCTION** and the main menu will be displayed as shown at right.

Note: If parental control is enabled, the receiver cannot be set into the program mode. See page 23.

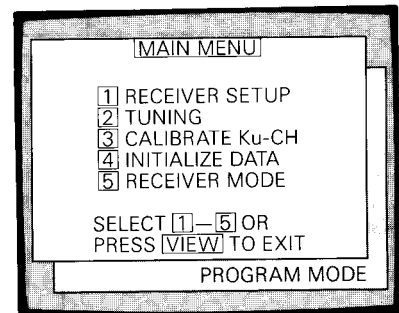

IN THE PROGRAM MODE

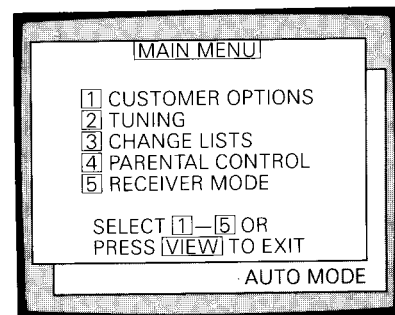

IN THE AUTO MODE

(b) Select the desired main function number by pressing an ALPHANUMERIC button. The main function chosen will be displayed as shown at right.

Ex. 1. When **FUNCTION**, **3** is pressed in the AUTO mode.

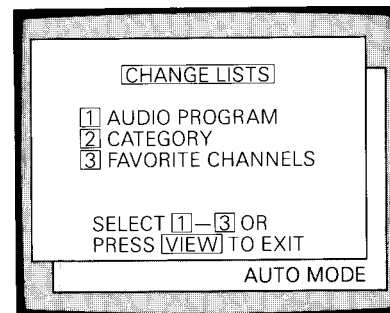

(c) Select the desired item number by an ALPHANUMERIC button. Operating instructions will appear on screen.

Ex. 2. When **1** is pressed after Ex. 1.

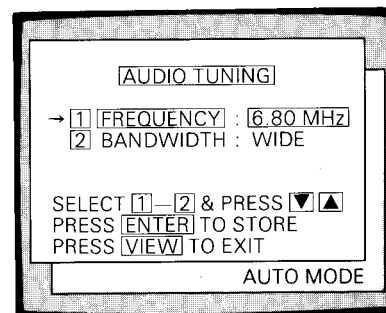

MAIN FUNCTIONS

— PROGRAM MODE —

1. RECEIVER SET UP

- (a) Press **FUNCTION**, **1** and the RECEIVER SET UP menu will be displayed as shown at right.
- (b) Select the item number (1–3).
Press EAST **▼** or WEST **▲** to set the desired mode.
- (c) Press **VIEW** to return.

The RECEIVER SET UP items are as follows.

1.1 CHANNEL SCAN (ON/OFF)

The channel scan feature allows the receiver to search rapidly for an active channel. The receiver stops scanning when a signal is found. When the channel signal is lost, the receiver begins scanning again. See the SAT-ELLITE POSITION MEMORY section (page 13).

1.2 AUTO TUNING (ON/OFF)

When this function is on, the antenna position and the skew is automatically fine-tuned.

1.3 INPUT MODE SELECTION (C/Ku or V/H)

Select C/Ku or V/H in accordance with the antenna and LNB configuration being used.

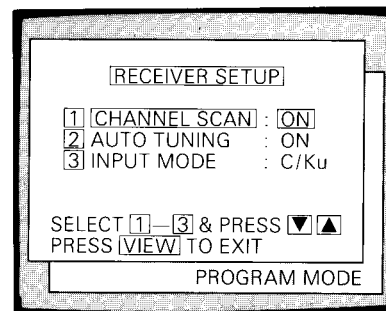

MAIN FUNCTIONS

2. TUNING

2.1 POLARITY/SKEW & VIDEO FINE TUNING

This function is available both in the PROGRAM mode and AUTO mode.

POLARITY/SKEW TUNING

Polarity settings are factory programmed and are selected when recalling a satellite and a channel. Normally it is not necessary to change the polarity. When the factory polarity does not correspond to the channel polarity, it can be changed and stored.

VIDEO FINE TUNING

By using this function it is possible to reduce video noise/interference. See VIDEO FINE TUNING section (page 25).

- Press **FUNCTION**, **2**, **1** and the display will be as shown at right.
- Select the item number to be changed.
- Change setting by pressing EAST **▼** or WEST **▲**.
- Press **VIEW** to EXIT.

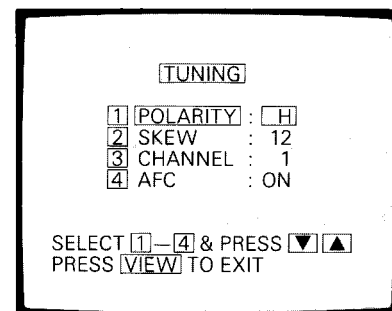

(When AFC is ON)

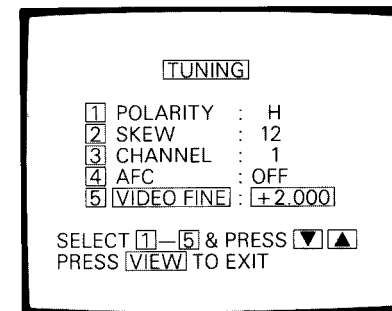

(When AFC is OFF)

The items are as follows.

- POLARITY**
Select H for the horizontal polarity, or V for the vertical polarity.
- SKEW**
Change the angle of the probe in the feedhorn.
- CHANNEL**
Changing the satellite channel being received.
- AFC (Auto Frequency Control)**
Select AFC (Auto Frequency Control) ON or OFF.
- VIDEO FINE TUNING**
Tunes the video frequency.
The video frequency can be tuned only when the AFC is OFF.

2.2 CHANGE MOTOR LIMITS

The motor limits can be changed as follows.

- Set the receiver to PROGRAM mode.
- Press **FUNCTION**, **2**, **2** and the display will be as shown at right.
- Select **1** for EAST limit or **2** for WEST limit and press **CANCEL** to cancel the old motor limit.
- Move the dish to the new east or west limit. Press **ENTER** to store the new motor limit.

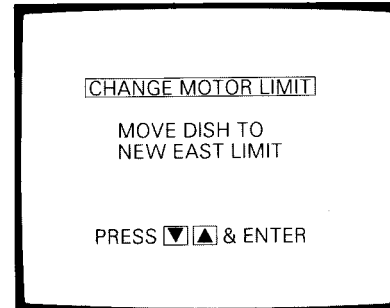
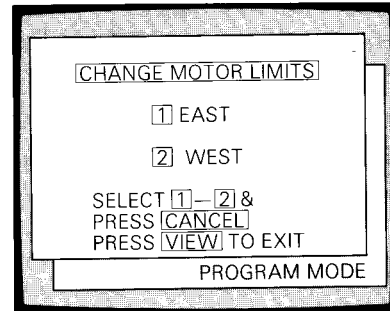

EX. When the EAST limit is canceled.

3. CALIBRATE Ku-CHANNELS

This function is used to assign any channel frequency to any channel number on the Ku-band. A Ku-band satellite channel can be programmed as follows.

- Set the receiver to the AUTO mode. Select the Ku-band satellite to be calibrated.
- Set the receiver to the PROGRAM mode.
- By using the channel **v** or **^** buttons, or the ALPHANUMERIC buttons, input the channel number to be programmed.
- Press **FUNCTION**, **3** and the display will be as shown at right.
- By using the EAST **▼** or WEST **▲** buttons, adjust the frequency for the best picture.
- Press **ENTER** to store the channel frequency.

If it is desired to program additional channels, operate again from (c). When completed, set the receiver mode to AUTO.

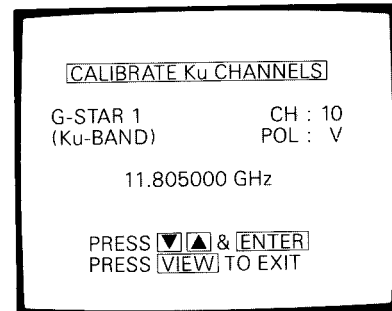

ADVANCED OPERATION

MAIN FUNCTIONS

4. INITIALIZE DATA

This function is used to erase and initialize all data which has been programmed.

- (a) Set the receiver to the PROGRAM mode.
- (b) Press **FUNCTION**, **4** and the display will be as shown at right.

Select **1** and press **ENTER** to erase and initialize all data.

Note: When data is initialized, the audio level is set to maximum.

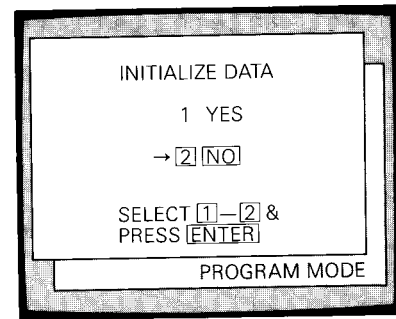

5. RECEIVER MODE

The 2 modes of the receiver are PROGRAM and AUTO. The PROGRAM mode is used when entering the east and west limits and satellite positions. The AUTO mode is used after initial programming is completed.

- (a) Press **FUNCTION**, **5** and the display will be as shown at right.
- (b) Select **1** for the AUTO mode, **2** for the PROGRAM mode and press **ENTER**.

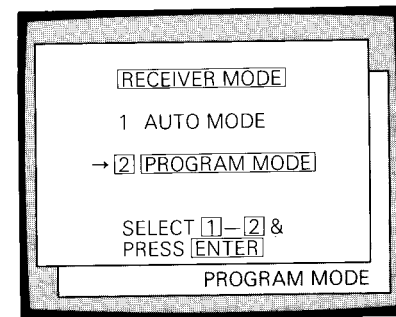

— AUTO MODE —

1. CUSTOMER OPTIONS

(a) Press **FUNCTION**, **1** and the CUSTOMER OPTIONS MENU will be displayed as shown at right.

By pressing EAST **▼** or WEST **▲**, select ON or OFF. Press **VIEW** to return to normal mode.

(c) The CUSTOMER OPTIONS items are as follows.

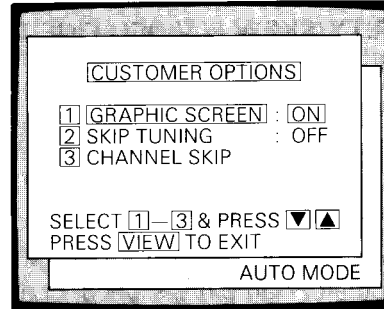

1.1 GRAPHIC SCREEN (ON/OFF)

This function is used to turn the GRAPHIC ON-SCREEN DISPLAY ON or OFF when the dish is moving between the satellites.

1.2 SKIP TUNING (ON/OFF)

When this function is on, the channel **v** **^** buttons will select the same polarities first and the opposite polarities second.

Ex. 1, 3, 5, 7, 9,, 2, 4, 6, 8, 10,

1.3 CHANNEL SKIP

When **3** is selected, the display will be as shown at right.

This receiver can be programmed to skip one or more channels of a satellite.

When programming a channel skip: Select the desired channel by pressing EAST **▼** or WEST **▲**. Press **ENTER** and the channel is programmed to be skipped. An "S" will be displayed when selecting the other channel. Press **VIEW** to clear the on screen display.

When canceling a channel skip: Pressing EAST **▼** or WEST **▲** to select the desired channel to cancel a skip. Press **CANCEL** and the skip will be canceled. Press **VIEW** to clear the on screen display.

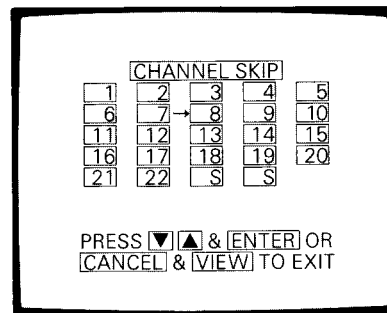

On the C-band satellite

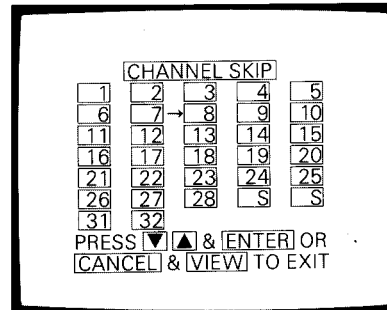

On the Ku-band satellite

ADVANCED OPERATION

MAIN FUNCTIONS

2. TUNING

2.1 POLARITY/SKEW & VIDEO FINE TUNING

See page 45 for operation.

2.2 REALIGN MEMORY

This function is used when a sensor wire has come loose, an actuator clamp has slipped, or an actuator has been reinstalled after a repair. It allows realignment of the actuator to match the already stored satellite positions without having to reprogram all of the satellites. Memory can be restored if all satellites are mispositioned either east or west by the same amount.

- (a) Confirm that the receiver is in the AUTO mode.
- (b) Select an active channel on the desired satellite that is programmed.
- (c) Press **FUNCTION**, **2**, **2** and the display will be as shown at right.
- (d) By using EAST **▼** or WEST **▲**, move the antenna to the position for the best picture.
Press **ENTER** to realign the satellite memory.

Note: There must be a satellite name on the OSD to enter this function. If a satellite name does not appear, move EAST **▼** or WEST **▲**, until one is found.

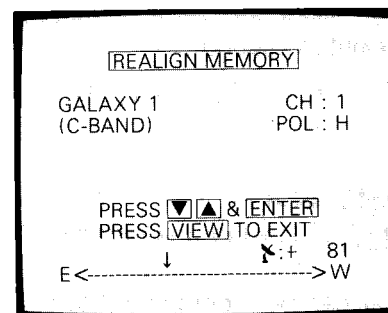

3. CHANGE LISTS

3.1 AUDIO PROGRAM

20 audio subcarriers are factory programmed. If desired, the audio program can be changed as follows.

(a) Press **FUNCTION**, **3**, **1** and the display will be as shown at right.

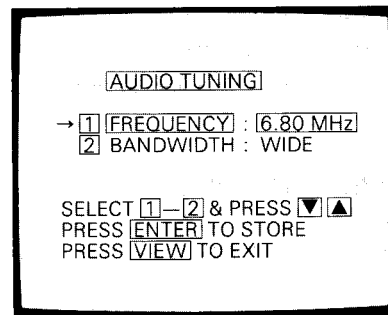

(b) Select 1.

By pressing EAST ▼ or WEST ▲, select the desired audio subcarrier.

Select 2.

By pressing EAST ▼ or WEST ▲, select the desired bandwidth WIDE or NARROW.

Press **ENTER** and the AUDIO program will be displayed as shown at right.

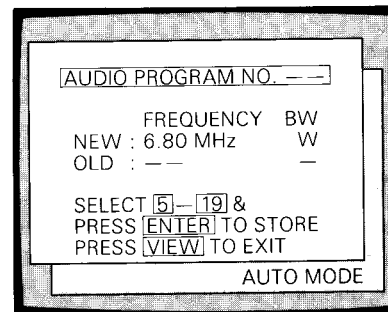

Select the AUDIO PROGRAM number (5—19) that is to be changed, and press **ENTER**.

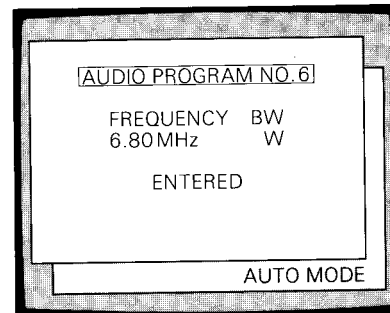

(c) If it is undecided which program number to store, press **AUDIO**. Then the AUDIO PROGRAM list will be displayed as shown at right.

Press **<** or **>** to see the next or previous list. Press **VIEW** to return.

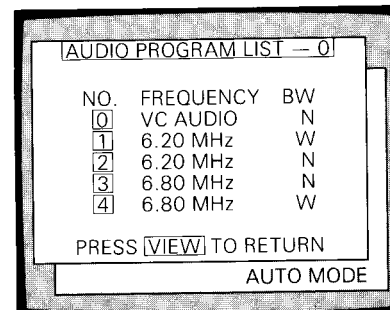

AUDIO PROGRAM 0 (VC AUDIO) is only for VideoCipher® channels. AUDIO PROGRAM 0, 1, 2, 3 and 4 cannot be changed.

ADVANCED OPERATION

3.2 CATEGORY

By using this function, it is possible to change the stored data for category selection.

See CATEGORY SELECTION section (page 18) to operate.

3.3 FAVORITE CHANNELS

This receiver can store up to 20 favorite programs.

See FAVORITE CHANNELS section (page 21) to operate.

4. PARENTAL CONTROL

This receiver has two parental control functions, antenna lock and channel lockout.

See page 23 for operation.

5. RECEIVER MODE

The 2 modes of the receiver are PROGRAM and AUTO. The PROGRAM mode is used when entering the east and west limits and satellite positions. The AUTO mode is used after initial programming is completed.

- (a) Press **FUNCTION** , **5** and the display will be as shown at right.
- (b) Select **1** for the AUTO mode, **2** for the PROGRAM mode and press **ENTER** .

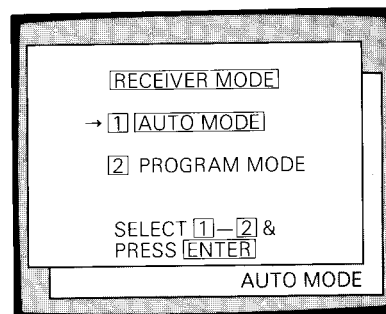

TROUBLESHOOTING

The TRX-500 is designed to give years of trouble free service. However, if a problem should occur, please check the following before calling your dealer.

problem: No picture or sound, no front panel light.

solution: Check that the receiver AC cord is plugged into an active wall outlet.

problem: No picture or sound, but the front panel lights are on.

solution: Check that the antenna is aimed to an operating satellite.

Check all cable connections.

Check to be sure television is tuned to channel 3 or 4 channel when using the RF modulator. (When using VHF OUT and VHF IN of this receiver.)

problem: No picture but sound is OK.

solution: Check cable connections to the video monitor or television.

problem: Snowy or sparkly picture.

solution: Check antenna alignment, polarity fine tuning and all interconnect cables. On some weak transponders, some snow in the picture may be normal.

Tune the video frequency. (Page 25)

problem: No sound or noisy sound but the picture is OK.

solution: Check the volume and mute controls.

Check the audio program and the audio tuning.

Check all audio cables for worn insulation or shorts.

problem: Antenna does not return accurately to all satellites.

solution: Check the mounting of the actuator on the antenna, and mounting bolts on the antenna.

Realign satellites by using the REALIGN MEMORY SECTION in the MAIN MENU (Page 49).

problem: The receiver can not be set to the PROGRAM mode.

solution: Confirm that the PARENTAL CONTROL is off.

problem: When the parental control password has been forgotten.

solution: Use 1048.

problem: When an unusual condition occurs and the remote control buttons do not operate.

solution: Unplug the AC cord.

Wait a few minutes and reconnect.

In the event you have questions or problems with any of the features or functions listed in this manual please call our CUSTOMER SUPPORT HOTLINE at

(800) 631-3811

When connected, press Prompt #4—Product Hook-Up and Information.

TROUBLESHOOTING

●PROGRAMMING A NEW SATELLITE

A new satellite can easily be stored into memory by performing the following steps:

- (a) Move to a satellite closest to the one you desire to enter.
- (b) Put receiver into the program mode.
- (c) Press **C-SAT** or **Ku-SAT**.
- (d) Enter the 2-digit name for the desired satellite using the ALPHANUMERIC buttons.
- (e) Choose a known active channel on the desired satellite (refer to a current programming guide.)
- (f) Use the EAST **▼** or WEST **▲** buttons to move to the desired satellite location.
- (g) Press **ENTER**.
- (h) Return the receiver to the AUTO MODE.

●FINE TUNING A SATELLITE

A snowy or poor picture can be fine tuned.

IN AUTO MODE

- (a) Move to the satellite to be fine tuned.
- (b) Put receiver into Program Mode.
- (c) Make sure AUTO TUNING is on (Page 44).
- (d) Press **C-SAT** or **Ku-SAT**.
- (e) Enter the 2-digit name of the satellite you are viewing.
- (f) Press **ENTER**. The skew and antenna positioner will automatically adjust to the best possible picture.
- (g) Put receiver back into Auto Mode.

●DELETING A SATELLITE

- (a) By pressing **FUNCTION**, **5**, **2**, **ENTER**, set the receiver to the PROGRAM mode.
- (b) Press **C-SAT** or **Ku-SAT** and continuously press **CANCEL**. The display will be as shown at right.

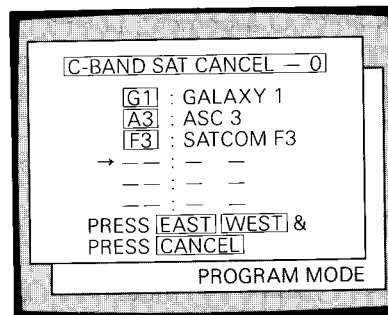

- (c) By pressing EAST **▼** or WEST **▲**, select the desired satellite name to be canceled. Press **<** or **>** to see the next or previous list. Press **CANCEL** to delete the data.

SPECIFICATIONS

RF

Input Frequency	950 to 1450 MHz
Input Impedance	75 Ω
Noise Figure	12 dB
Image Rejection	45 dB
Input Signal Level	-60 to -30 dBm
L.O. Leakage at Input Terminal	-50 dBm max.
2nd IF Frequency	402.78 MHz
Threshold	7 dB (C/N)
Bandwidth	27 MHz

VIDEO PERFORMANCE

Video Out	
Format	NTSC
De-Emphasis	CCIR REC. 405-1
Output Impedance	75 Ω
Frequency Response (10 KHz to 4.2 MHz)	+1/-3 dB
Output Level	1 Vp-p \pm 2 dB

AUDIO PERFORMANCE

Bandwidth	330 KHz/150 KHz (selectable)
De-emphasis	75 μ s
Subcarrier Frequency	5.0 to 8.5 MHz tuneable
Frequency Response	\pm 1 dB (30 to 15 KHz)
Output Impedance	600 Ω Unbalanced
Output Level	-4.2 dBs \pm 2.5 dB at 75 KHz Deviation
Signal to Noise	60 dB

RF MODULATOR

Output Frequency	VHF US 3 or 4ch selectable
Output Level	66 dB μ V \pm 3 dB

POWER

Primary Power	120V AC, 60 Hz
Power Consumption	170W (max.)
Power Supply to LNB	15 to 21.2V DC, 250mA max.
Polarizer Output (Motor Driven type)	5 \pm 0.5V, 1.0A max.

ACTUATOR INTERFACE

Motor Power (M1, M2)	36V max., 2.5A max. class 2
5V Supply	5.5V min. 6.0V max.
Sense (Reed Switch) (Hall)	Form C closure +5V TTL Level

ENVIRONMENTAL CONDITIONS

Ambient Operation Temperature	+0 to +40 $^{\circ}$ C (32 to 104 $^{\circ}$ F)
Humidity	Indoor Environment

MECHANICAL

Size	16-15/16" \times 4-3/16" \times 14-7/8"
Mass	17 lbs

SUPPLIED ACCESSORIES

1. Remote Control
2. Two "AAA" size Batteries
3. Video Cable
4. Audio Cable

Design and specifications are subject to change without notice.

TOSHIBA AMERICA CONSUMER PRODUCTS, INC.

BRANCH OFFICE/CHICAGO: 1010 JOHNSON DRIVE, BUFFALO GROVE, ILLINOIS 60089-6900
TECHNICAL SUPPORT: 800-631-3811, Prompt #4