

TOSHIBA



DVD VIDEO PLAYER **SD-3990SU** **SD-3990SC**

OWNER'S MANUAL



Introduction	2
Connections	11
Basic playback	15
Advanced playback	21
Function setup	31
Others	39



© 2005 Toshiba Corporation

SAFETY PRECAUTIONS

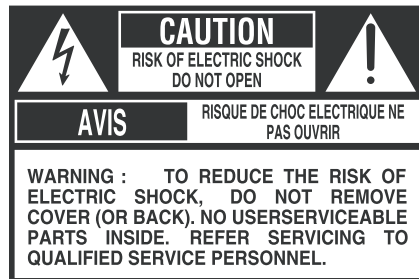

The lightning flash with arrowhead symbol, within an equilateral triangle, is intended to alert the user to the presence of uninsulated "dangerous voltage" within the product's enclosure that may be of sufficient magnitude to constitute a risk of electric shock to persons.



The exclamation point within an equilateral triangle is intended to alert the user to the presence of important operating and maintenance (servicing) instructions in the literature accompanying the appliance.



The symbol for CLASS II (Double Insulation)

- WARNING:** TO REDUCE THE RISK OF FIRE OR ELECTRIC SHOCK, DO NOT EXPOSE THIS APPLIANCE TO RAIN OR MOISTURE. DANGEROUS HIGH VOLTAGES ARE PRESENT INSIDE THE ENCLOSURE. DO NOT OPEN THE CABINET. REFER SERVICING TO QUALIFIED PERSONNEL ONLY.
- CAUTION:** TO PREVENT ELECTRIC SHOCK, MATCH WIDE BLADE OF PLUG TO WIDE SLOT, FULLY INSERT.
- ATTENTION:** POUR EVITER LES CHOCS ELECTRIQUES, INTRODUIRE LA LAME LA PLUS LARGE DE LA FICHE DANS LA BORNE CORRESPONDANTE DE LA PRISE ET POUSSER JUSQU'AU FOND.
- CAUTION:** PLEASE READ AND OBSERVE ALL WARNINGS AND INSTRUCTIONS GIVEN IN THIS OWNER'S MANUAL AND THOSE MARKED ON THE UNIT. RETAIN THIS BOOKLET FOR FUTURE REFERENCE.

IMPORTANT SAFETY INSTRUCTIONS

1. Read these instructions.
2. Keep these instructions.
3. Heed all warnings.
4. Follow all instructions.
5. Do not use this apparatus near water.
6. Clean only with dry cloth.
7. Do not block any ventilation openings. Install in accordance with the manufacturer's instructions.
8. Do not install near any heat sources such as radiators, heat registers, stoves, or other apparatus (including amplifiers) that produce heat.
9. Do not defeat the safety purpose of the polarized or grounding-type plug. A polarized plug has two blades with one wider than the other. A grounding type plug has two blades and a third grounding prong. The wide blade or the third prong are provided for your safety. If the provided plug does not fit into your outlet, consult an electrician for replacement of the obsolete outlet.
10. Protect the power cord from being walked on or pinched particularly at plugs, convenience receptacles, and the point where they exit from the apparatus.
11. Only use attachments/accessories specified by the manufacturer.

IMPORTANT SAFETY INSTRUCTIONS

12. Use only with the cart, stand, tripod, bracket, or table specified by the manufacturer, or sold with the apparatus. When a cart is used, use caution when moving the cart/apparatus combination to avoid injury from tip-over.



Introduction

13. Unplug this apparatus during lightning storms or when unused for long periods of time.

14. Refer all servicing to qualified service personnel. Servicing is required when the apparatus has been damaged in any way, such as power-supply cord or plug is damaged, liquid has been spilled or objects have fallen into the apparatus, the apparatus has been exposed to rain or moisture, does not operate normally, or has been dropped.

ADDITIONAL SAFETY INSTRUCTIONS

15. When you use headphones, keep the volume at a moderate level. If you use the headphones continuously with high volume sound, it may cause hearing damage.

16. Do not overload wall outlets; extension cords, or integral convenience receptacles as this can result in a risk of fire or electric shock.

17. Apparatus shall not be exposed to dripping or splashing and no objects filled with liquids, such as vases, shall be placed on the apparatus.

18. Keep your fingers well clear of the disc tray as it is closing. Neglecting to do so may cause serious personal injury.

19. Do not place a heavy object on or step on the apparatus. The object may fall, causing serious personal injury and serious damage to the apparatus.

20. Do not use a cracked, deformed, or repaired disc. These discs are easily broken and may cause serious personal injury and apparatus malfunction.

21. If the apparatus should smoke or smell, immediately disconnect the power cord from the wall outlet. Wait until the smoke or smell stops, then ask your dealer for a check and repair. Neglecting to do so may cause fire.

22. While it is thundering, do not touch the connecting cables or the apparatus.

23. The apparatus includes lead, an ingredient of solder used on the PCB, which is a harmful substance to human and the environment. When disposing of this apparatus, follow the rules and regulations in your area.

IMPORTANT SAFETY INSTRUCTIONS

CAUTION: This Digital Video Disc Player employs a Laser System.
To ensure proper use of this product, please read this owner's manual carefully and retain for future reference. Should the unit require maintenance, contact an authorized service location.

Use of controls or adjustments or performance of procedures other than those specified herein may result in hazardous radiation exposure.

To prevent direct exposure to laser beam, do not try to open the enclosure.
Visible and invisible laser radiation when open and interlocks defeated.
DO NOT STARE INTO BEAM.

FCC NOTICE: This equipment has been tested and found to comply with the limits for a Class B digital device, pursuant to part 15 of the FCC Rule. These limits are designed to provide reasonable protection against harmful interference in a residential installation. This equipment generates, uses, and can radiate radio frequency energy and, if not installed and used in accordance with the instructions, may cause harmful interference to radio communications.

However, there is no guarantee that interference will not occur in a particular installation. If this equipment does cause harmful interference to radio or television reception, which can be determined by turning the equipment off and on, the user is encouraged to try to correct the interference by one or more of the following measures:

- Reorient or relocate the receiving antenna.
- Increase the separation between the equipment and receiver.
- Connect the equipment into an outlet on a circuit different from that to which the receiver is connected.
- Consult the dealer or an experienced radio/TV technician for help.

Changes or modifications made to this equipment, not expressly approved by Toshiba, or parties authorized by Toshiba, could void the user's authority to operate the equipment.

The instructions shall state that an ALL-POLE MAINS SWITCH with a contact separation of at least 3 mm in each pole shall be incorporated in the electrical installation of the building.

CAUTION: These servicing instructions are for use by qualified service personnel only. To reduce the risk of electric shock do not perform any servicing other than that contained in the operating instructions unless you are qualified to do so.

In the spaces provided below, record the Model and Serial No. located on the rear panel of your DVD video player.

Model No. _____

Serial No. _____

Retain this information for future reference.

Location of the required label

CERTIFICATION: COMPLIES WITH FDA RADIATION PERFORMANCE STANDARDS, 21 CFR SUBCHAPTER J.

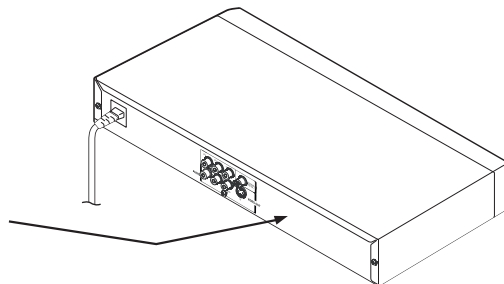

Be aware that this equipment is still powered even after the ON/STANDBY indicator turns off (standby mode) by pressing the ON/STANDBY button. To disconnect this equipment completely from the mains power, pull out the power plug from the wall outlet.

Precautions

Notes on handling

- When shipping the DVD video player, the original shipping carton and packing materials come in handy. For maximum protection, repack the unit as it was originally packed at the factory. Take care not to give it a shock or shake when carrying.
- Do not use volatile liquids, such as insect spray, near the DVD video player. Do not leave rubber or plastic products in contact with the DVD video player for a long time. They will leave marks on the finish.
- The top and rear panels of the DVD video player may become warm after a long period of use. This is not a malfunction.
- When the DVD video player is not in use, be sure to remove the disc and turn off the power.
- If you do not use the DVD video player for a long period, the unit may not function properly in the future. Turn on and use the DVD video player occasionally.

Notes on locating

- Place the DVD video player on a level surface. Do not use it on a shaky or unstable surface such as a wobbling table or inclined stand. The loaded disc may come off the proper position and cause damage to the DVD video player.
- When you place this DVD video player near a TV, radio, or VCR, the playback picture may become poor and the sound may be distorted. In this case, place the DVD video player away from the TV, radio, or VCR.

Notes on cleaning

Use a soft, dry cloth for cleaning.

- For stubborn dirt, soak the cloth in a weak detergent solution, wring well and wipe. Use a dry cloth to wipe it dry.
Do not use any type of solvent, such as thinner and benzene, as they damage the surface of the DVD video player.
- If you use a chemical saturated cloth to clean the unit, follow that product's instructions.

Inspection and Maintenance

This DVD video player is a high technology, precision device. If the optical pick-up lens and disc drive parts become dirty or worn down, the picture quality may be reduced. To avoid reduction in picture quality, it is recommended that regular inspection and maintenance (cleaning or parts replacement) be performed every 1,000 hours of use. For further details, contact your nearest consumer electronics dealer.

Notes on moisture condensation

Moisture condensation damages the DVD video player. Please read the following carefully.

Moisture condensation occurs, for example, when you pour a cold drink into a glass on a warm day. Drops of water form on the outside of the glass. In the same way, moisture may condense on the optical pick-up lens inside this unit, one of the most crucial internal parts of the DVD video player.

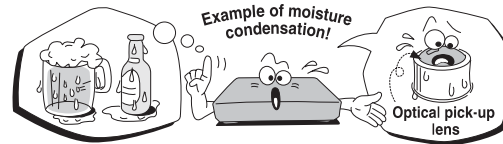

- Moisture condensation occurs during the following cases.
- When you bring the DVD video player directly from a cold place to a warm place.
- When you use the DVD video player in a room where you just turned on the heater, or a place where the cold wind from the air conditioner directly hits the unit.
- In summer, when you use the DVD video player in a hot and humid place just after you move the unit from an air conditioned room.
- When you use the DVD video player in a humid place.

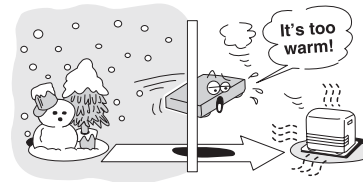

- Do not use the DVD video player when moisture condensation may occur.

If you use the DVD video player in such a situation, it may damage discs and internal parts. Remove the disc, connect the power cord of the DVD video player to the wall outlet, turn on the DVD video player, and leave it for two or three hours. After two or three hours, the DVD video player will have warmed up and evaporated any moisture. Keep the DVD video player connected to the wall outlet and moisture condensation will seldom occur.

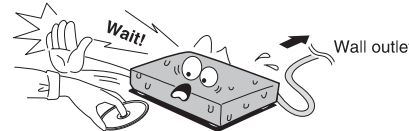

Notes on Discs

On handling discs

- Do not touch the playback side of the disc.

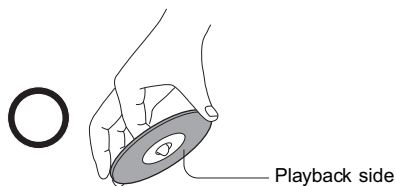

- Do not attach paper or tape to discs.



On cleaning discs

- Fingerprints and dust on the disc cause picture and sound deterioration. Wipe the disc from the center outwards with a soft cloth. Always keep the disc clean.



- If you cannot wipe off the dust with a soft cloth, wipe the disc lightly with a slightly moistened soft cloth and finish with a dry cloth.
- Do not use any type of solvent such as thinner, benzene, commercially available cleaners or antistatic spray for vinyl LPs. It may damage the disc.

On storing discs

- Do not store discs in a place subject to direct sunlight or near heat sources.
- Do not store discs in places subject to moisture and dust such as a bathroom or near a humidifier.
- Store discs vertically in a case. Stacking or placing objects on discs outside of their case may cause warping.

Notes on copyright

The unauthorized recording, use, distribution, or revision of copyrighted materials including, without limitation, television programs, videotapes, and DVDs, is prohibited under the Copyright Laws of the United States and other countries, and may subject you to civil and criminal liability.

This product incorporates copyright protection technology that is protected by method claims of certain U.S. patents and other intellectual property rights owned by Macrovision Corporation and other rights owners. Use of this copyright

protection technology must be authorized by Macrovision Corporation, and is intended for home and other limited viewing uses only unless otherwise authorized by Macrovision Corporation. Reverse engineering or disassembly is prohibited.

Structure of disc contents

Normally, DVD video discs are divided into titles, and the titles are subdivided into chapters. VIDEO CDs and audio CDs are divided into tracks. DVD video disc

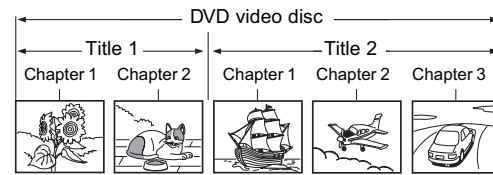

VIDEO CD/audio CD

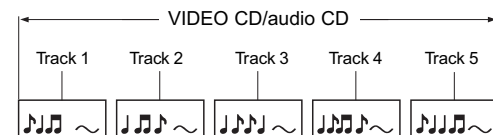

Each title, chapter or track is assigned a number, which is called "title number", "chapter number" or "track number" respectively. There may be discs that do not have these numbers.



Notes on Discs (continued)

About this owner's manual

This owner's manual explains the basic instructions of this DVD video player. Some DVD video discs are produced in a manner that allows specific or limited operation during playback. As such, the DVD video player may not respond to all operating commands. This is not a defect in the DVD video player. Refer to instruction notes of discs.

"⊘" may appear on the TV screen during operation. A "⊘" means that the operation is not permitted by the DVD video player or the disc.

Notes on region numbers

The region number of this DVD video player is 1. If region numbers, which stand for their playable area, are printed on your DVD video disc and you do not find  or , disc playback will not be allowed by the player. (In this case, the DVD video player will display a message on-screen.)

Some DVDs that have no region code label may still be subject to area restrictions and therefore not playable.



On VIDEO CDs

This DVD video player supports VIDEO CDs equipped with the PBC (Version 2.0) function. (PBC is the abbreviation of Playback Control.) You can enjoy two playback variations depending on types of discs.

- VIDEO CD not equipped with PBC function (Version 1.1)
Sound and movie can be played on this DVD video player in the same way as an audio CD.
- VIDEO CD equipped with PBC function (Version 2.0)
In addition to operation of a VIDEO CD not equipped with the PBC function, you can enjoy playback of interactive software with search function by using the menu displayed on the TV screen (Menu Playback). Some of the functions described in this owner's manual may not work with some discs.

Playable discs

This DVD video player can play the following discs.

	Disc Mark	Contents	Disc Size	Maximum playback time
DVD video discs		Audio + video (moving pictures)	12 cm	Approx. 4 hours (single sided disc) Approx. 8 hours (double sided disc)
			8 cm	Approx. 80 minutes (single sided disc) Approx. 160 minutes (double sided disc)
	VIDEO CDs		12 cm	Approx. 74 minutes
			8 cm	Approx. 20 minutes
Audio CDs		Audio	12 cm	Approx. 74 minutes
			8 cm (CD single)	Approx. 20 minutes

The following discs are also available.

- DVD-R/DVD-RW discs of DVD video format
 - CD-R/CD-RW discs of CD-DA, Video CD, MP3, WMA or JPEG format
- Some of these discs may be incompatible.

- You cannot play discs other than those listed above.
- You cannot play DVD-RAM discs or non-standardized discs, etc., even if they may be labeled as above.
- This DVD video player uses the NTSC color system, and cannot play DVD video discs recorded in any other color system (PAL, SECAM, etc.).

Because of problems and errors that can occur during the creation of DVD and CD software and/or the manufacture of DVD and CD discs, Toshiba cannot guarantee that this DVD video player the DVD will play every feature of every DVD bearing the DVD logo and/or every CD bearing the CD logo. As one of the creators of DVD technology, Toshiba DVD players are manufactured using the highest standards of quality, and as a result, such incompatibilities are rare. If you happen to experience any difficulty playing a DVD or a CD on this DVD video player, please feel free to contact us via the methods listed in the United States and Canadian Limited Warranties on pages [42](#) and [43](#).

Table of Contents

Introduction

- SAFETY PRECAUTIONS 2
- IMPORTANT SAFETY INSTRUCTIONS 3
- Precautions 5
- Notes on Discs 5
 - Notes on region numbers 6
- Table of Contents 7
- Identification of Controls 8
 - Front panel 8
 - Rear panel 8
 - DVD display 8
 - Remote control 9
 - Loading batteries 10
 - Operating with the remote control 10

Connections

- Connecting to a TV 12
 - Connecting to a TV 12
 - Connecting to an audio system and TV equipped with component video inputs 13
- Connecting to Optional Equipment 13
 - Connecting to an amplifier equipped with a Dolby Digital decoder 13
 - Connecting to an amplifier equipped with Dolby Surround Pro Logic 14
 - Connecting to an amplifier equipped with a DTS decoder 14
 - Connecting to an amplifier equipped with a MPEG2 audio decoder 14
 - Connecting to an amplifier equipped with a digital audio input 14

Basic playback

- Playing a Disc 16
 - Basic playback 16
- Variable Speed Playback 18
 - Playing in fast reverse or fast forward directions 18
 - Playing frame by frame 18
 - Playing in slow-motion 18
 - Resuming playback from the same location 18
- Locating a Desired Section 19
 - Locating a title using the top menu 19
 - Locating a desired section by entering the corresponding number 20
 - Locating a specific chapter or track 20

Advanced playback

- Accessing a Specific Location Directly 22
 - Entering the time counter of the desired location 22
- Repeating a Specific Segment 22
 - Repeating a specific segment 22
- Playing in a Varied Order 23
 - Playing titles, chapters or tracks in a varied order 23
- Playing in a Favorite Order 23
 - Setting titles, chapters, or tracks in a favorite order 23
- Selecting the Picture/Sound Enhancement (E.P.M./E.A.M.) 24
 - Selecting the picture enhancement 24
 - Selecting the sound enhancement 24
- Zooming a Picture 24
 - Zooming a picture 24
- Selecting the Camera Angle 25
 - Changing the camera angle 25
- Selecting Subtitles 25
 - Selecting a subtitle language 25
- Selecting a Language 26
 - Selecting a playback audio setting 26
- On-screen Display Operation 26
 - On-screen display operation 26
- Playing MP3/WMA Files 27
 - Playing MP3/WMA files 27
- Viewing JPEG Files 29
 - Viewing JPEG files 29
 - Viewing a thumbnail view 29
- Playing DivX® Files 30
 - Playing DivX® files 30

Function setup

- Customizing the Function Settings 32
 - Setting procedure 32
 - Setting details 34
- Table of Languages 38

Others

- Before Calling Service Personnel 40
- Specifications 41
- United States Warranty 42
- Canadian Warranty Information 43

Identification of Controls

See the page in □ for details.

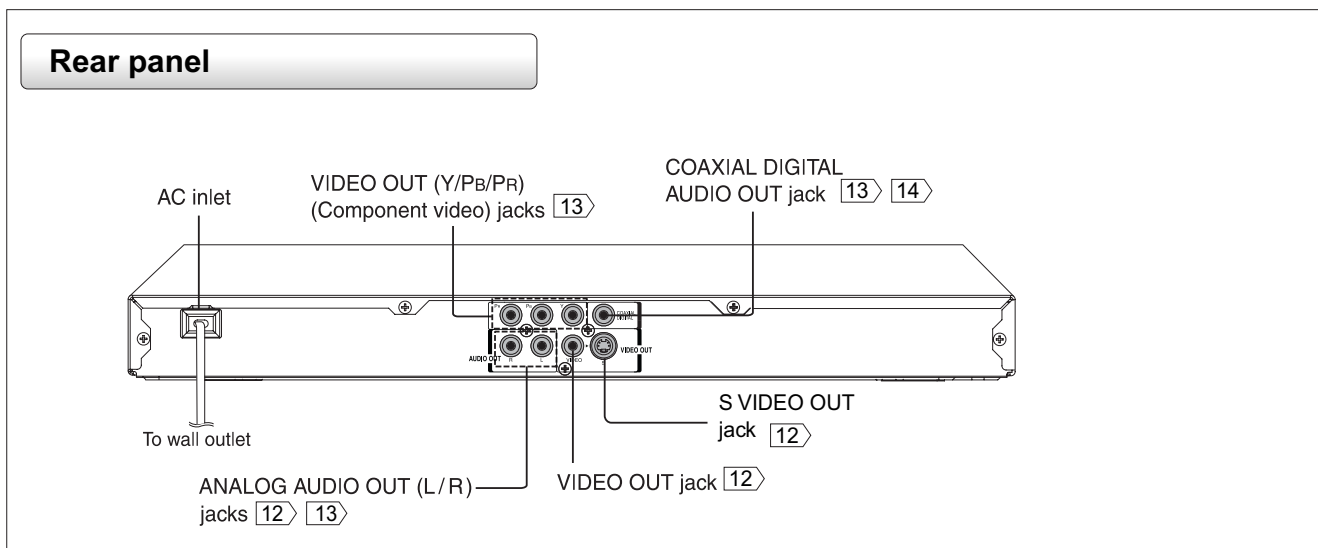
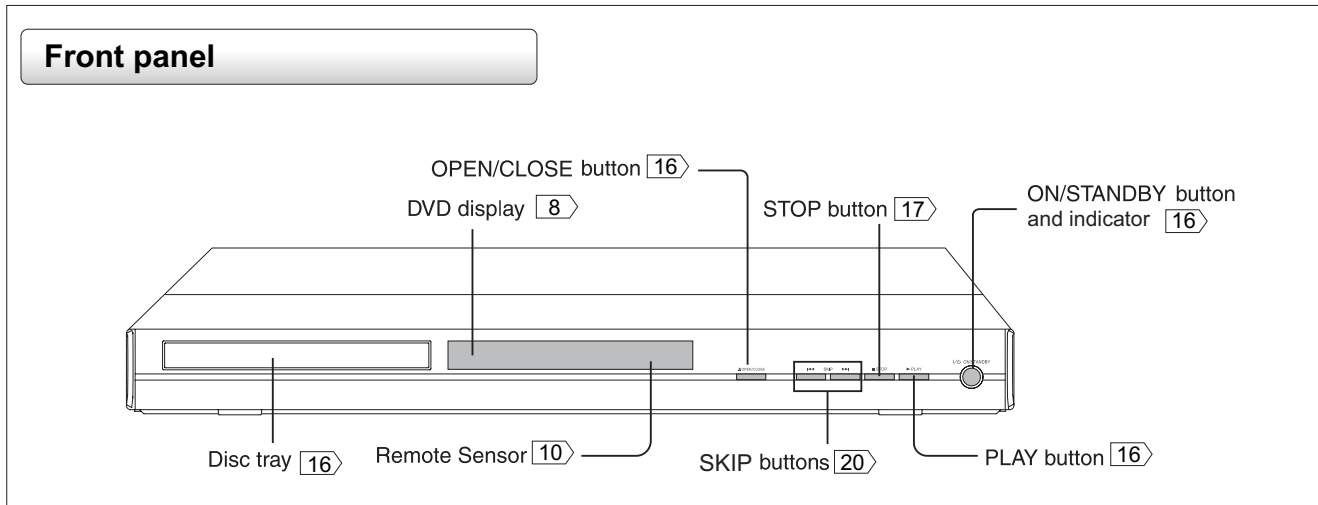

DVD display

Chapter/Track number indicator

Multifunctional indicator (indicates operating status or messages, etc.)

The indicators vary depending on the kinds of discs you play.

DVD video disc	VIDEO CD	Audio CD	OPEN	LOAD/CLOSE
<ul style="list-style-type: none"> • During playback: Example	<ul style="list-style-type: none"> • During playback: Example	<ul style="list-style-type: none"> • During playback: Example		
Some discs may only display chapter numbers.	Some discs may only display track numbers.	Some discs may only display track numbers.		

Identification of Controls (continued)

The instructions in this manual describe the functions on the remote control. See the page in □ for details.

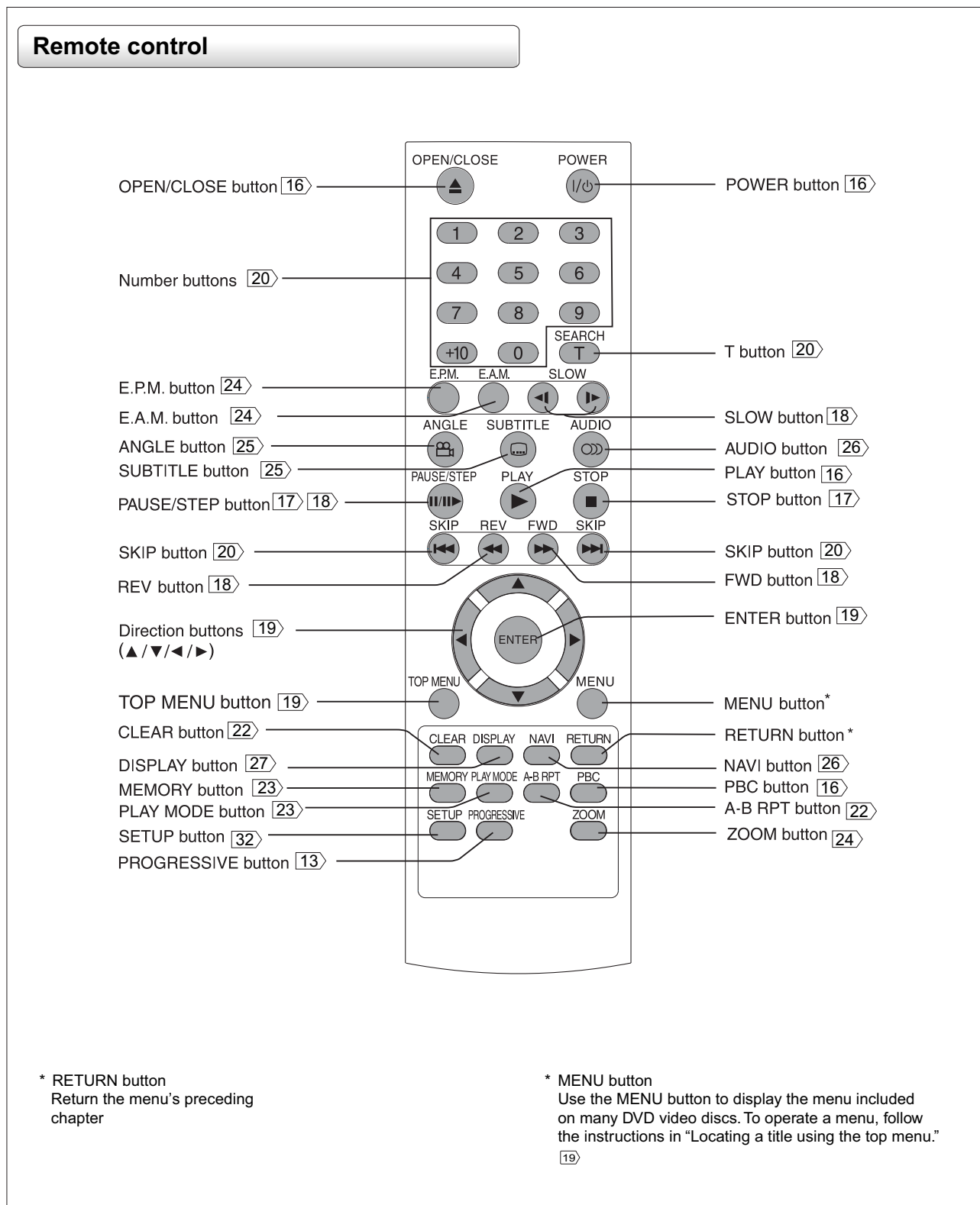

Loading batteries

1 Open the cover.

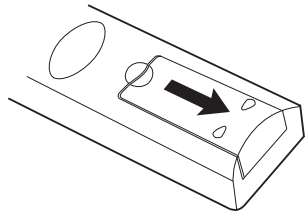

2 Insert batteries (AAA size).

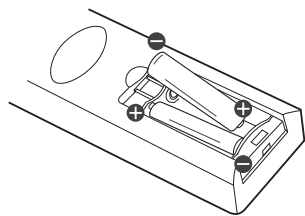

Make sure to match the + and – on the batteries to the marks inside the battery compartment.

Caution:

Never throw batteries into a fire.

Note:

- Be sure to use AAA size batteries.
- Dispose of batteries in a designated disposal area.
- Batteries should always be disposed of with the environment in mind. Always dispose of batteries in accordance with applicable laws and regulations.
- If the remote control does not operate correctly, or if the operating range becomes reduced, replace batteries with new ones.
- When necessary to replace batteries in the remote control, always replace both batteries with new ones. Never mix battery types or use new and used batteries in combination.
- Always remove batteries from remote control if they are dead or if the remote control is not to be used for an extended period of time. This will prevent battery acid from leaking into the battery compartment.

Operating with the remote control

Point the remote control at the remote sensor and press the buttons.

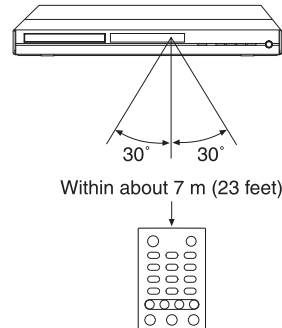

Distance: About 7 m (23 feet) from the front of the remote sensor
 Angle: About 30° in each direction of the front of the remote sensor

* Do not expose the remote sensor of the DVD video player to a strong light source such as direct sunlight or other illumination. If you do so, you may not be able to operate the DVD video player via the remote control.

Notes on the remote control

- Direct the remote control at the remote sensor of the DVD video player.
- When using the remote control, press the buttons at intervals of about 1 second to ensure the correct mode of operation.
- Do not drop or give the remote control a shock.
- Do not leave the remote control near an extremely hot or humid place.
- Do not spill water or put anything wet on the remote control.
- Do not open the remote control.

Connections

Read this chapter first to make all necessary preparations.

- **Connecting to a TV**
- **Connecting to an audio system and TV equipped with component video inputs**
- **Connecting to an amplifier equipped with a Dolby Digital decoder**
- **Connecting to an amplifier equipped with Dolby Surround Pro Logic**
- **Connecting to an amplifier equipped with a DTS decoder**
- **Connecting to an amplifier equipped with an MPEG2 audio decoder**
- **Connecting to an amplifier equipped with a digital audio input**

Connecting to a TV

Connect the DVD video player to your TV.

For details of output sound, see 26.

Connecting to a TV

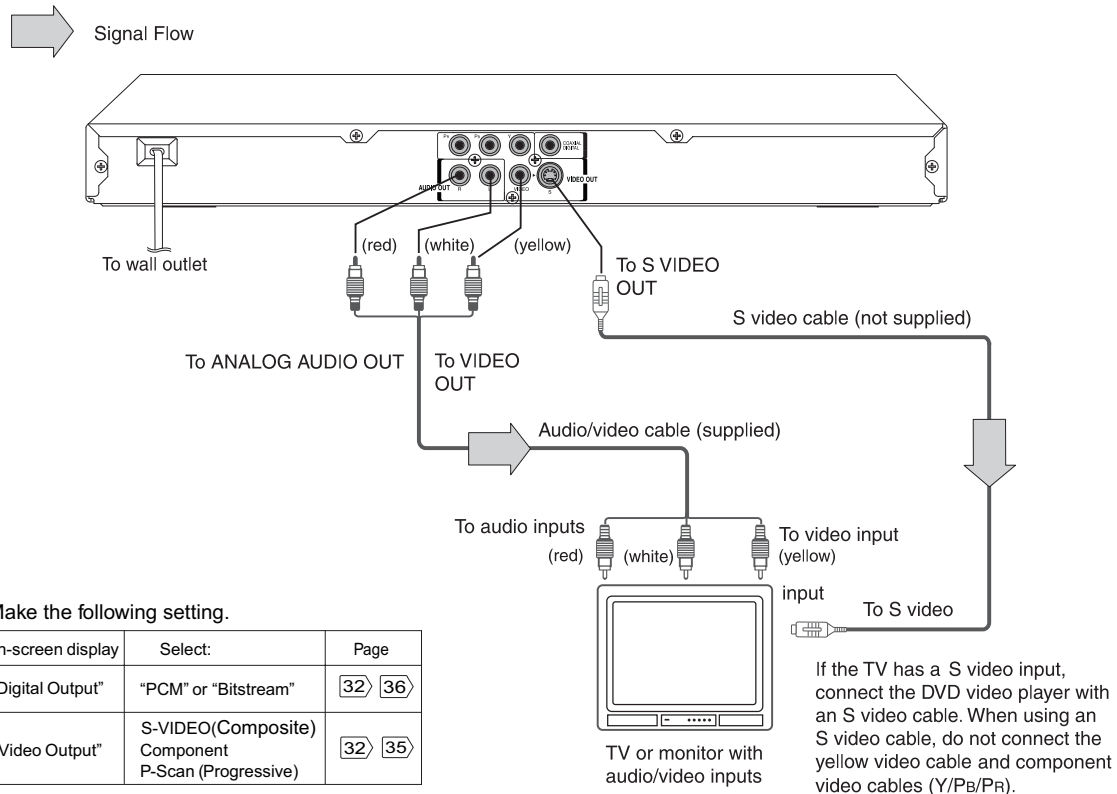

Notes

- Refer to the owner's manual of the connected TV as well.
- When you connect the DVD video player to your TV, be sure to turn off the power and unplug both units from the wall outlet before making any connections.
- If your television set has one audio input, connect the left and right audio outputs of the DVD video player to a Y cable adapter (not supplied) and then connect to your TV.
- Connect the DVD video player directly to your TV. If you connect the DVD video player to a VCR, TV/VCR combination or video selector, the playback picture may be distorted as DVD video discs are copy protected.
- Analog audio out will not have sound if DTS playback is selected.

Interlaced outputs (ColorStream[®])

Some TVs or monitors are equipped with component video inputs. Connecting to these inputs allows you to enjoy higher quality picture playback. Actual labels for component video inputs may vary depending on the TV manufacturer. (ex. Y, R-Y, B-Y or Y, Cb, Cr)
In some TVs or monitors, the color levels of the playback picture may be reduced slightly or the tint may change. In such a case, adjust the TV or monitor for optimum performance.

Progressive outputs (ColorStream Pro[®])

Some TVs or monitors are equipped with component video inputs that are capable of reproducing a progressively scanned video signal. Connecting to these inputs allows you to view the highest quality pictures with less flicker.

Consumers should note that not all high definition television sets are fully compatible with this product and may cause artifacts to be displayed in the picture. In case of 525 progressive scan picture problems, it is recommended that the user switch the connection to the "standard definition" output. If there are questions regarding our TV set compatibility with this model 525p DVD player, please contact our Customer Service Center.

Connecting to an audio system and TV equipped with component video inputs

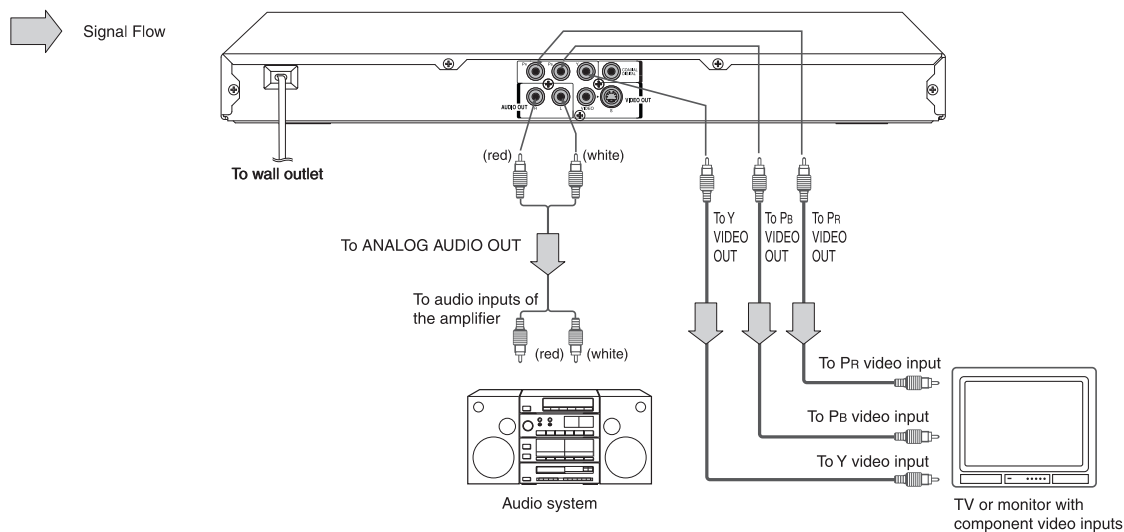

Switching the output signal (interlaced/progressive) using the remote control

You can temporarily switch the output signal for better picture quality.

Press **PROGRESSIVE** on the remote control during stop mode.

Press **PROGRESSIVE** again to turn off progressive mode.

If your TV does not support the progressive scan format, the picture will appear scrambled or blank. To return to normal picture, press **PROGRESSIVE** button again to turn off progressive mode.

- Make the following setting.

On-screen display	Select:	Page
"Digital Output"	"PCM" or "Bitstream"	32 36
"Video Output"	Component * P-Scan (Progressive)	32 35

* Only for TV equipped with component video input jacks which support the progressive scan.

Notes

- Refer to the owner's manual of the connected equipment as well.
- When you connect the DVD video player to other equipment, be sure to turn off the power and unplug all of the equipment from the wall outlet before making any connections.
- If you place the DVD video player near a tuner or radio, the radio broadcast sound might be distorted. In this case, place the DVD video player away from the tuner and radio.
- The output sound of the DVD video player has a wide dynamic range. Be sure to adjust the receiver's volume to a moderate listening level. Otherwise, high volume sound may damage your hearing as well as the speakers.
- Turn off the amplifier before you connect or disconnect the DVD video player's power cord. If you leave the amplifier power on, the speakers may be damaged.
- Progressive can be on/off only when "Video Output" is set to Component or Progressive (35).
- In component connections, the screen might become pinkish in color when the "Video Output" is set to S-VIDEO. This is not a defect of this unit (35).
- When Progressive is on, only component video will be output.
- Analog audio out will not have sound if DTS playback is selected.
- When using component video cables, do not connect the S video cable.

ColorStream® and ColorStream Pro® are registered trademarks of Toshiba America Consumer Products, L.L.C.

Connecting to Optional Equipment

You can enjoy high quality dynamic sounds by connecting the DVD video player to optional audio equipment.

Connecting to an amplifier equipped with a Dolby Digital decoder

Dolby Digital

Dolby Digital is the surround sound technology used in theaters showing the latest movies, and is now available to reproduce this realistic effect in the home. You can enjoy motion picture and live concert DVD video discs with this dynamic realistic sound by connecting the DVD video player to a 6 channel amplifier equipped with a Dolby Digital decoder or Dolby Digital processor. If you have a Dolby Surround Pro Logic decoder, you will obtain the full benefit of Pro Logic from the same DVD movies that provide full 5.1-channel Dolby Digital soundtracks, as well as from titles with the Dolby Surround mark.

Manufactured under license from Dolby Laboratories. "Dolby", "Pro Logic" and the double-D symbol are trademarks of Dolby Laboratories. Confidential unpublished works. Copyright 1992-1997 Dolby Laboratories. All rights reserved.

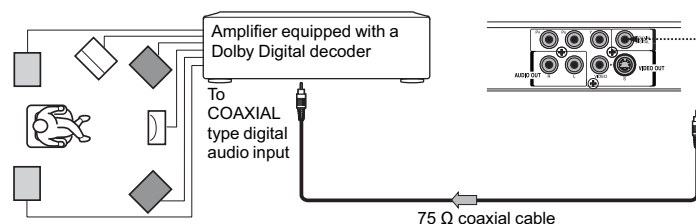

- Use DVD video discs encoded via the Dolby Digital recording system.
- Make the following setting.

On-screen display	Select:	Page
"Digital Output"	"PCM" or "Bitstream"	32 36
Recording system	D	26

Connecting to an amplifier equipped with Dolby Surround Pro Logic

Dolby Surround Pro Logic

You can enjoy the dynamic realistic sound of Dolby Surround Pro Logic by connecting an amplifier and speaker system (right and left front speakers, a center speaker, and one or two rear speakers).

- With an amplifier equipped with Dolby Digital
Connect the equipment the same way as described in "Connecting to an amplifier equipped with a Dolby Digital decoder." Refer to that amplifier's owner's manual and set the amplifier so you can enjoy Dolby Surround Pro Logic sound.
- With an amplifier not equipped with Dolby Digital
Connect the equipment as follows.

• Make the following setting.

On-screen display	Select:	Page
"Digital Output"	"PCM" or "Bitstream"	32 36

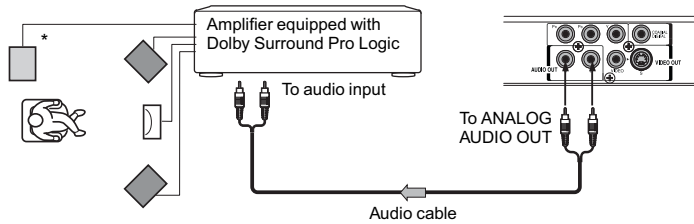

* Connect one or two rear speakers. The output sound from the rear speakers will be monaural even if you connect two rear speakers.

Connecting to an amplifier equipped with a DTS decoder

Digital Theater Systems (DTS)

DTS is a high quality surround technology used in theaters and now available for home use, on DVD video discs or audio CDs.

If you have a DTS decoder or processor, you can obtain the full benefit of 5.1 channel DTS encoded sound tracks on DVD video discs or audio CDs.

"DTS" and "DTS Digital Out" are trademarks of Digital Theater Systems, Inc.

- Use DVD video discs or audio CDs encoded via the DTS recording system.
- Make the following setting.

On-screen display	Select:	Page
"Digital Output"	Bitstream	32 36
Recording system	DTS	26

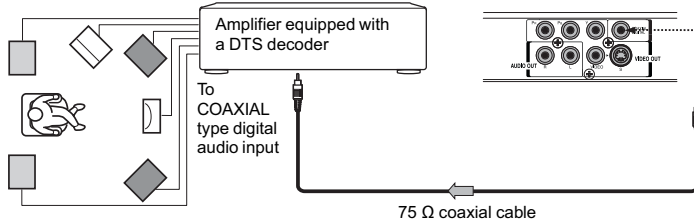

Connecting to an amplifier equipped with a MPEG2 audio decoder

MPEG2 sound

You can enjoy motion picture and live concert DVD video discs with dynamic realistic sound by connecting an amplifier equipped with an MPEG2 audio decoder or MPEG2 audio processor.

- Use DVD video discs encoded via the MPEG2 recording system.
- Make the following setting.

On-screen display	Select:	Page
"Digital Output"	"PCM" or "Bitstream"	32 36
Recording system	MPEG2	26

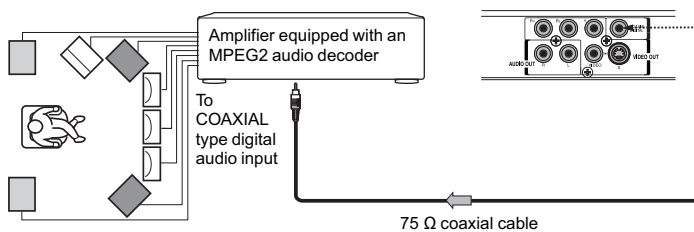

Connecting to an amplifier equipped with a digital audio input

2 channel digital stereo

You can enjoy the dynamic sound of 2 channel digital stereo by connecting an amplifier equipped with a digital audio input and speaker system (right and left front speakers).

• Make the following setting.

On-screen display	Select:	Page
"Digital Output"	PCM	32 36

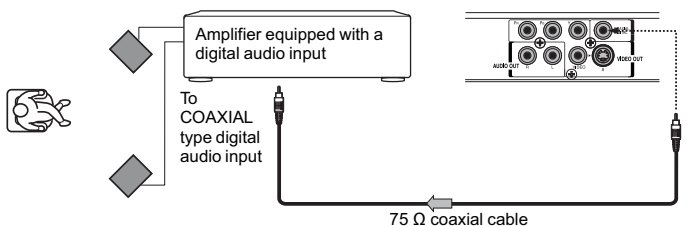

Basic playback

Begin your operation.

- Playing a Disc
- Variable Speed Playback
- Locating a Desired Section

Playing a Disc

This section shows you the basics on how to play a disc.

CAUTION
Keep your fingers well clear of the disc tray as it is closing. Neglecting to do so may cause serious personal injury.

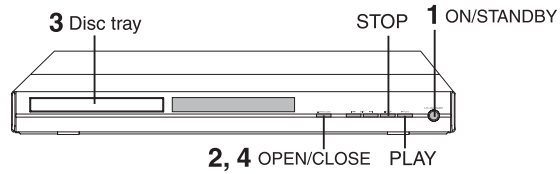

Basic playback

Preparations

- When you want to view a disc, turn on the TV and select the video input connected to the DVD video player.
- When you want to enjoy the sound of discs from the audio system, turn on the audio system and select the input connected to the DVD video player.

1 Press the ON/STANDBY button.

POWER  The DVD video player turns on. The ON/STANDBY indicator on the front panel will light up in green.

2 Press OPEN/CLOSE.

OPEN/CLOSE  The disc tray opens.

3 Place the disc on the disc tray.

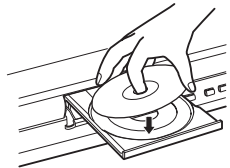





With the playback side down

- There are two different disc sizes. Place the disc in the correct guide on the disc tray. If the disc is out of the guide, it may damage the disc and cause the DVD video player to malfunction.
- Do not place a disc which is unplayable in this DVD video player.

4 Press OPEN/CLOSE to close the disc tray.

OPEN/CLOSE  Playback starts.

If you insert a DVD video disc that contains a top menu, a menu may appear. Use the  /  /  /  to select the title you want to view, then press ENTER to start playback. See "Locating a title using the top menu." [19](#)

- You may need to press the TOP MENU or MENU button to display disc menu (depending on the actual DVD video disc.)

Notes

- If the disc tray is holding a disc you have already played, playback will begin from the location where you last stopped. For resuming playback, see [18](#).
- Some video CD are recorded with PBC (Playback Control), a menu with recorded contents may appear on the TV if you have turned the PBC on. You can make your selection according to its PBC menu. Press the PBC button on the remote control to turn PBC on or off anytime during Video CD playback. When switching from PBC off to PBC on mode, playback will start from the beginning of the disc.

■ To start playback in the stop mode

Press **PLAY**.



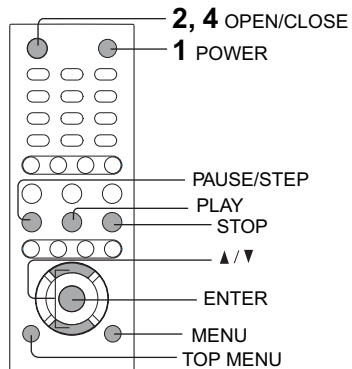

■ **To obtain a higher quality picture**

Occasionally, some picture noise not usually visible during a normal broadcast may appear on the TV screen while playing a DVD video disc because the high resolution pictures on these discs include a lot of information. While the amount of noise depends on the TV you use with this DVD video player, you should generally reduce the sharpness adjustment on your TV when viewing DVD video discs.

■ **About**

The icons on the heading bar show the playable discs for the function described under that heading.

: You can use this function with DVD video discs.

: You can use this function with VIDEO CDs.

: You can use this function with audio CDs.

■ **To pause playback (still mode)**

Press **PAUSE/STEP** during playback.



To resume normal playback, press the **PLAY** button.

- The sound is muted during still mode.

■ **To stop playback**

Press **STOP**.



■ **To remove the disc**

Press **OPEN/CLOSE**.



Remove the disc after the disc tray opens completely.

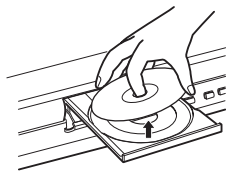

Be sure to press the **OPEN/CLOSE** button to close the disc tray after you remove the disc.

■ **To turn the power off (To enter the standby mode)**

Press **ON/STANDBY** to turn the unit to standby mode.

Note

Be aware that this equipment is still powered even after the **ON/STANDBY** indicator turns off (standby mode) by pressing the **ON/STANDBY** button. To disconnect this equipment completely from the main power, pull out the power plug from the wall outlet.

■ **About the screen saver**

When you leave the unit in DVD stop mode for approximately 2 minutes, the screen saver of the DVD video player automatically appears. To turn off the screen saver, press the **PLAY** button.

■ **Automatic Power Off function**

If the DVD video player is stopped, or the screen saver is engaged for approximately 20 minutes, the DVD video player will automatically turn itself off.

Notes

- Do not move the DVD video player during playback. Doing so may damage the disc.
- Use the **OPEN/CLOSE** button to open and close the disc tray. Do not push the disc tray while it is moving. Doing so may cause the DVD video player to malfunction.
- Do not push up on the disc tray or put any objects other than discs on the disc tray. Doing so may cause the DVD video player to malfunction.
- In many instances, a menu screen will appear after playback of a movie is completed. Prolonged display of an on-screen menu may damage your television set, permanently etching that image onto its screen. To avoid this, be sure to press the **STOP** button on your remote control once the movie is completed.

Variable Speed Playback

You can play discs at various speeds, and resume playback from the location where you stopped playback.

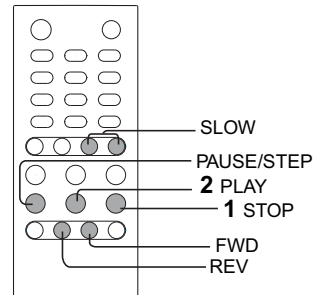

Playing in fast reverse or fast forward directions

Press REV or FWD during playback.

REV FWD

REV: Fast reverse playback
FWD: Fast forward playback

Each time you press the REV or FWD button, the playback speed changes.

To resume normal playback
Press PLAY.



- Notes
- The DVD video player mutes sound and subtitles during reverse and forward scan of DVD video discs.
 - The playback speed may differ depending on the disc.

Playing frame by frame

Press PAUSE/STEP during still playback.

PAUSE/STEP

Each time you press the PAUSE/STEP button, the picture advances one frame.

→

Pause → Step

Pause

To resume normal playback
Press PLAY.



- Note
- The sound is muted during frame by frame playback.

Playing in slow-motion

Press SLOW during playback.

SLOW

Each time you press the SLOW button, the slow-motion speed changes in the following sequence:

To resume normal playback
Press PLAY.



- Notes
- The sound is muted during slow-motion playback.
 - 3 speeds are available.

Resuming playback from the same location

1 Press STOP at the location where you want to interrupt playback.

STOP

The DVD video player memorizes the location where playback is stopped.

2 Press PLAY.

PLAY

The DVD video player resumes playback from the location where you stopped playback.

To start playback from the beginning regardless of the location where you stopped playback

1 Press STOP twice.

STOP

The DVD video player deletes the memory of the location.

2 Press PLAY.

PLAY

- DVD Playback starts from the beginning of the current title.
- VCD Playback starts from the beginning of the disc.
- CD Playback starts from the beginning of the disc.

- If you want to return to the beginning of a DVD video disc, open and close the disc tray once with the OPEN/CLOSE button before pressing the PLAY button.

Locating a Desired Section

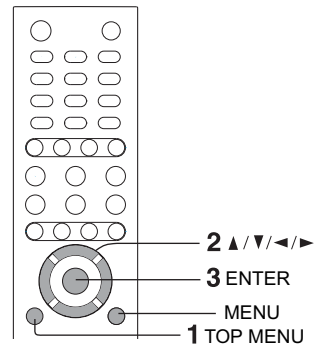

Normally, DVD video discs are divided into titles, and the titles are sub-divided into chapters. VIDEO CDs and audio CDs are divided into tracks. You can quickly locate any specific title, chapter, or track.

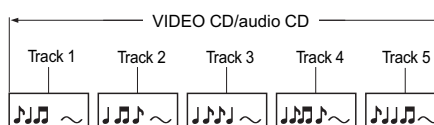
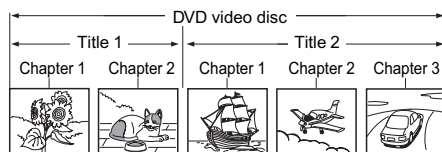

Basic playback

DVD Locating a title using the top menu

1 Press TOP MENU.

TOP MENU



The top menu appears on the TV screen.

e.g.

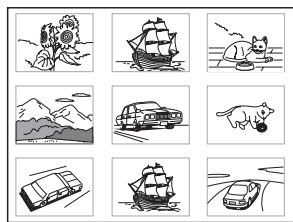

2 Press ▲/▼/◀/▶ to select the title you want.

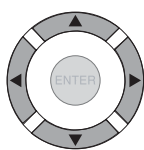

If the titles in the top menu are assigned a number, you can directly locate a specific title by pressing its designated number with the number buttons.

3 Press ENTER.

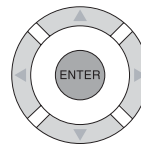

Playback starts from chapter 1 of the selected title.

Notes

- The instructions above describe basic procedures which may vary depending on the contents of the DVD video disc. If different instructions appear on the TV screen, follow those instructions.
- If you display the top menu during playback and press the TOP MENU button again without selecting any title, the DVD video player may resume playback from the point where you first pressed the TOP MENU button (depending on the actual DVD video disc.)
- This method of locating a title is available only on a disc that contains a top menu.
- Instruction notes of discs may refer to the button that displays the top menu as the TITLE button.

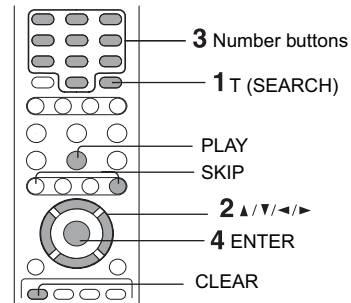

Locating a desired section by entering the corresponding number

1 Press T.
Press ▲ / ▼ to highlight the Title/Chapter or Track.

If you are using a VIDEO CD/audio CD, skip step 2. Then at step 3, enter the number for the track you want using the number buttons.

2 Press ▲ / ▼ to select a section you want to locate.

3 Press the number buttons to enter title, chapter or track number.

4 Press ENTER.

Playback starts from the selected section.

■ Accessing chapters/tracks using number buttons:

When you select a chapter/track number greater than "10", press number "1" plus any single number. Then press ENTER. For example, If you want to select chapter/track 12, just press the number button "1" and "2". The chapter/track number "12" will appear on the Search menu screen. Then press ENTER. If you want to clear the chapter/track number, press CLEAR button. But if you want to select chapter/track number 10, press +10 and then ENTER.

- Notes**
- Press the CLEAR button to clear the numbers. To clear the search menu screen, press the T button several times.
 - This method of locating a title is available only on a disc that contains title numbers.
 - For VCD wrth PBC on, accessing titles/tracks using number buttons does not work.
 - When you playback CD/DVD, SEARCH MENU may appear the number you selected by pressing any number button.

Locating a specific chapter or track

Press SKIP ►► or ◀◀ repeatedly to access the chapter or track number you want.
 Playback starts from the selected chapter or track.

SKIP ►► To locate succeeding chapters or tracks.

SKIP ◀◀ Playback starts from the beginning of the current chapter or track. When you press twice in quick successions, playback starts from the beginning of the preceding chapter or track.

Note

- Some titles may not display chapter numbers.

Advanced playback

Customizing the performance of your DVD video player.

- Accessing a Specific Location Directly
- Repeating a Specific Segment
- Playing in a Varied Order
- Playing in a Favorite Order
- Selecting the Picture /Sound Enhancement (E.P.M./ E.A.M.)
- Zooming a Picture
- Selecting the Camera Angle
- Selecting Subtitles
- Selecting a Language
- On-screen Display Operation
- Playing MP3/WMA Files
- Viewing JPEG Files
- Playing DivX® Files

Accessing a Specific Location Directly

The unit stores the points that you want to watch again up to 3 points. You can resume playback from each scene.

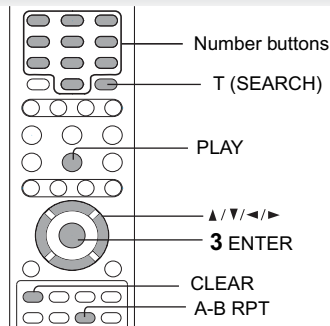

DVD VCD CD Entering the time counter of the desired location

1 Press T.
 SEARCH T Press ▲ / ▼ button to highlight the time counter.

2 Press the number buttons to enter the time.
 e.g.

3 Press ENTER.
 Playback starts from the desired location.

Notes

- Some discs may not respond to this process.
- Some scenes may not be located precisely as you specified.
- This method for accessing specific locations is available only within the current title of the DVD video disc or within the current track of the VIDEO CD / audio CD.

To set and play favorite bookmark during playback

1. Press T twice, the display of Bookmark appears, then press ENTER to mark the desired scene.

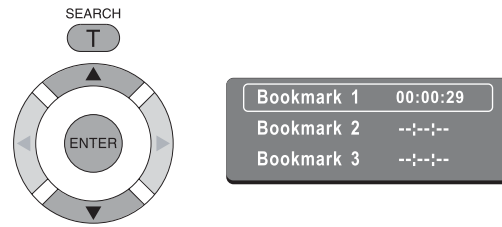

2. Press ENTER to play the favorite bookmark.

To set other bookmarks.

Follow step 1 and move through the menu by pressing the ▲ or ▼ button.

Press T again to remove this display.



To cancel the Bookmark

Follow step 1, then press CLEAR to cancel the bookmark. Move through the menu by pressing the ▲ or ▼ button to cancel other bookmarks.

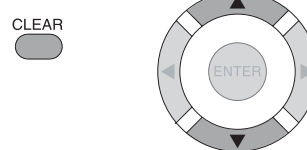

Notes

- Some discs may not work with marking operation.
- The marking is canceled when you open the disc tray or turn the power off.
- Some subtitles recorded around the marker may fail to appear.

Repeating a Specific Segment

You can specify a desired segment and repeat it.

DVD VCD CD Repeating a specific segment

1 Press A-B RPT at the beginning of the segment (point A) you want to play repeatedly.

2 Press A-B RPT again at the end of the segment (point B).
 The DVD video player automatically returns to point A and starts repeat playback of the selected segment (A-B).

To resume normal playback

Press A-B RPT until Rep Off is displayed.



Notes

- Some discs may not permit A-B repeat operation.
- You cannot set the A-B repeat function for a segment that includes multiple camera angles [25].
- You can specify a segment only within the current title or track (VIDEO CD).
- There may be a slight difference between point A and the location where playback actually resumes depending on the disc.

Playing in a Varied Order

You can play titles, chapters within a title, or tracks in a varied order.

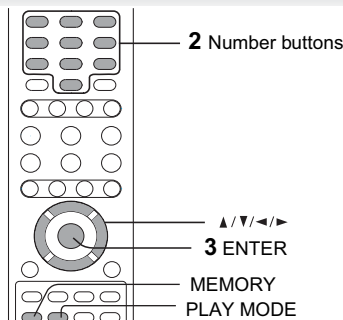

DVD VCD Playing titles, chapters or tracks in a varied order

1 Press PLAY MODE.

Press PLAY MODE button to select desired features and then press ENTER button to toggle desired mode.

e.g.

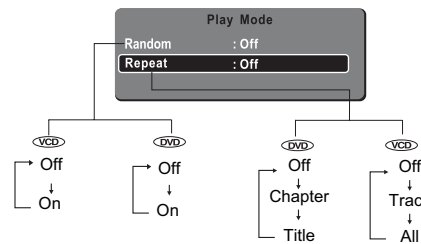

Chapter:

Repeats the chapters within the current title.

Title:

Repeats the current title.

Track:

Repeats the current track.

All:

Repeats the entire disc.

Off:

Resumes normal playback.

Note

Some discs may not permit these operations.

Above function is only used for DVD/VCD, when you playback MP3/WMA/JPEG/DivX®, please refer to 27 28.

Playing in a Favorite Order

You can combine your favorite titles, chapters or tracks and play them in the order you determine. You can program up to 12 selections into the memory. (Memory playback)

DVD VCD Setting titles, chapters, or tracks in a favorite order

1 Insert a disc and press MEMORY, and then press ► to input your favorite order.

MEMORY e.g.

The following display appears.

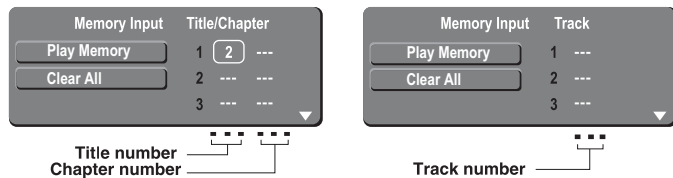

2 Select the items in the order you want by pressing the number buttons.

Each time you press the ▲/▼/◀/▶ button, the space is highlighted in turn. Highlight where you want to enter, then press the corresponding number buttons.

To select another chapter in the same title, you do not need to select the title number.

To select tracks from a VIDEO CD in order, press the number buttons for the track.

If you input a wrong number, press CLEAR button to input new number.

3 Press ▲/▼/◀/▶ to move the highlighted bar to Play Program, then press the ENTER.

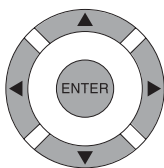

The DVD video player starts memory playback.

■ To change the programmed selections

- 1 While the display appears on the TV screen, press ▲/▼/◀/▶ to move the highlighted bar to the item you want to change.
- 2 Change the selection following the instructions in step 2.

■ To cancel the programmed selections

- 1 While the display appears on the TV screen, press ▲/▼/◀/▶ to move the highlighted bar to the item you want to cancel.
- 2 Press CLEAR.

■ To resume normal playback from memory playback

Press MEMORY button.

Press ▲/▼/◀/▶ to move the highlighted bar to Clear All, then press the ENTER. All the input Memories will be cleared.

Press PLAY button to resume normal playback.



Normal playback will start from first location.

■ To program during playback

If you press the MEMORY button during playback, a programming display appears. Follow steps 2 and 3.

Notes

- Some discs may not permit memory playback operation.
- If you select repeat 23 during memory playback, the DVD video player repeats the current memory playback.
- If you press the MEMORY button while the display appears on the TV screen, the display disappears.
- The programmed selections will be cleared when you turn off the DVD video player.

Advanced playback

Selecting the Picture/Sound Enhancement (E.P.M.* / E.A.M.*)

You can easily select a preferred picture/audio enhancement.

*E.P.M.: Enhanced Picture Mode

*E.A.M.: Enhanced Audio Mode

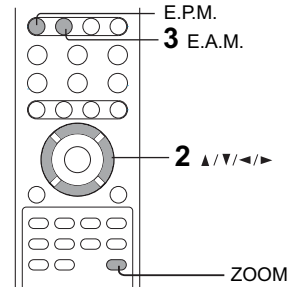

Selecting the picture enhancement

1 Press E.P.M.

E.P.M.

The picture enhancement menu appears.



2 Select the picture enhancement by pressing ▲ / ▼, then press ◀ / ▶ to make your selections.

Each time you press the ◀ / ▶ button, the picture enhancement changes.

■ To exit the picture enhancement selection Press E.P.M. again.

E.P.M.



Note

Actual effect to picture may vary depending on the TV. Make selection according to your preference.

Selecting the sound enhancement

1 Press E.A.M.

E.A.M.

The sound enhancement will appear:



Press the E.A.M. button again, the sound enhancement change to off.

3D*:

To obtain expansive virtual surround sound effects from two speakers. To use this enhancement on sounds output from the ANALOG AUDIO OUT jacks, be sure to set "Digital Output" to "PCM".

* Effective in playback of a DVD video disc or a VIDEO CD.

■ To exit the audio enhancement selection

Leave the DVD video player unattended for about 2 seconds after having made a selection.

Notes

- Actual effects to sounds may vary depending on the speaker system. Make selection according to your preference.
- Actual effects to sounds may vary depending on the disc.
- When the DVD video player is connected to an amplifier equipped with Dolby Surround Pro Logic, select "3D Effect Off". Otherwise, Dolby Surround Pro Logic may function differently than usual.

Zooming a Picture

You can magnify areas within a picture.

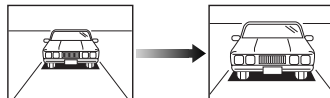

Zooming a picture

1 Press ZOOM during normal, slow or still playback.

ZOOM

The centre part of the image will be zoomed in.

e.g.

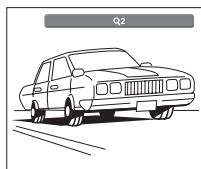

Each time you press the ZOOM button, the magnification level changes as follows:

Q 1 → Q 2 → Q 3 → Q Off

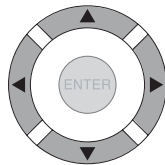

Press the ZOOM button to select the magnificant level. Press the ▲ / ▼ / ◀ / ▶ buttons to view a different part of the image. You may move the image from the centre position to UP, DOWN, LEFT and RIGHT direction. When you reach the edge of the image, the display will not shift anymore in that direction.

ZOOM

Q Off

Press the ZOOM button repeatedly until the Q Off is displayed.

■ To resume normal playback

Press ZOOM repeatedly until the Q Off is displayed. Original picture is restored.

ZOOM



Notes

- Some discs may not respond to zoom feature.
- During some scenes, the buttons may not work as described.
- Zooming does not work on subtitles or menus included on DVD video discs.
- The magnification level varies depending on the picture size you select. [24]

Selecting the Camera Angle

If the scene was recorded from multiple angles, you can easily change the camera angle of the scene you are watching.

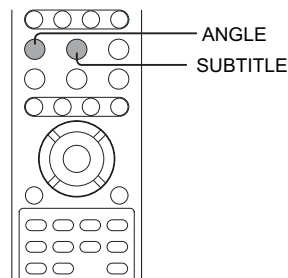
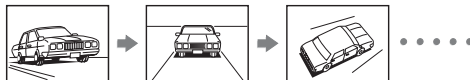

DVD Changing the camera angle

1 Press ANGLE while playing a scene recorded with multiple angles.



While playing a scene recorded with multiple angles, press the ANGLE button.

e.g. 3/3

Number changes to show the number of the current angle. (The maximum number of possible angles is 9)

2 Press ANGLE while the angle number is displayed on the TV screen.



Press the ANGLE button repeatedly to change the scene to the next angle in those recorded.

- About two seconds later, playback continues from the new angle you selected.
- If no button is pressed within 2 seconds, playback continues without changing the current angle.

To resume normal playback

Press the ANGLE repeatedly until the "1/3" is displayed.

Notes:

- This function can only be used for discs on which scenes shot from multiple angles have been recorded.
- If only one angle is recorded, "1/1" is displayed.

To change the picture transition mode of JPEG playback.

Press ANGLE button during JPEG playback will change the picture transition mode as follows:

Wipe Down
Wipe Up
Center In
Center Out
Blind Down
Blind Up
Random
None

The picture transition mode is displayed above the TV screen.

Advanced playback

Selecting Subtitles

You can display subtitles on the TV screen and select a subtitle language from those included on the DVD video disc.



DVD Selecting a subtitle language

1 Press SUBTITLE during playback.



The current subtitle setting is displayed.

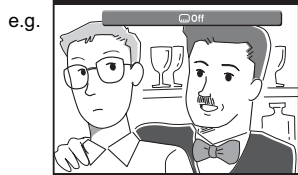

2 Press SUBTITLE while the subtitle setting is displayed on the TV screen.

Each time you press the SUBTITLE button, the subtitle languages included on the DVD video disc change.

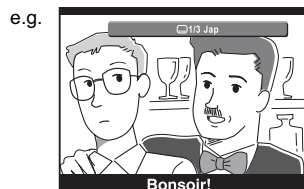

To turn off the subtitle setting display, press the SUBTITLE button repeatedly until "Off" is displayed.

To turn subtitles on or off

1 Press SUBTITLE during playback.



2 Press SUBTITLE repeatedly until the "Off" is displayed.

Notes

- Some DVD video discs are set to display subtitles automatically, and you cannot turn them off even if you set the subtitle function to off.
- During some scenes, the subtitles may not appear immediately after you select your desired.
- Some DVD video discs will allow you to make subtitle selections and turn subtitles on or off only via the disc menu.

Notes

- When you turn on the DVD video player or replace a disc, the player returns to the initial default setting [37].
- When you select a subtitle language which is not included on the disc, the DVD video player plays a prior language programmed on the disc.
- During some scenes, the subtitles may not appear immediately after you change the subtitle language.

Selecting a Language

You can select a preferred language and sound recording system from those included on the DVD video disc.

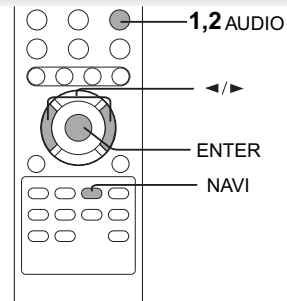

Selecting a playback audio setting

1 Press AUDIO during playback.



The current audio setting is displayed.

e.g. 2/2 D D 6 Ch Eng

Recorded audio format number changes sequentially. (The maximum number of possible audio formats is 8)

The abbreviation of the language appears instead of the language name. Refer to the list of languages and their abbreviations. [38](#)

2 Press AUDIO while the audio setting is displayed on the TV screen.



Each time you press the AUDIO button, the audio settings included on the DVD video disc change.

To turn off the audio setting display, press the AUDIO button.

Notes

- When you turn on the DVD video player or replace a disc, player returns to the initial default setting [37](#).
- If you select a sound track which is not included on the disc, the DVD video player plays a prior sound track programmed on the disc.
- Some discs allow you to change audio selections only via the disc menu. If this is the case, press the MENU button and choose the appropriate language from the selections on the disc menu.

Selecting sound channels of VIDEO CDs



Press AUDIO repeatedly during playback to hear a different audio channel (Left, Right, Mix or Stereo).

Output sound conversion table

Input	Output	COAXIAL DIGITAL AUDIO OUT jack		ANALOG AUDIO OUT Jacks
		"Digital Output" 32 36	"PCM"	
DVD video disc	Dolby Digital	"Bitstream"	PCM	○
	Linear PCM	PCM	PCM	○
	DTS	"Bitstream"	"Bitstream"	—
	MPEG1, MPEG2	"Bitstream"	PCM	○
VIDEO CD	MPEG1	PCM	PCM	○
Audio CD	Linear PCM 44.1 kHz/16 bit	PCM	PCM	○
	DTS	"Bitstream"	"Bitstream"	—
	MP3/WMA	PCM	PCM	○

: 3D sound enhancement can function.

- Signals of 96kHz from the COAXIAL DIGITAL AUDIO OUT jack are depressed to 48 kHz by down sampling process when:

– "3D Effect On" is selected. [24](#)

– a copyright protected disc is played.

- Quantization bit of signals of 20 bit or higher which is output from the COAXIAL DIGITAL AUDIO OUT jack is 16 bit if they are in a copyright protected disc.

On-screen Display Operation

When you turn on the on-screen display, you can view information on operational status and access features and settings.

On-screen display operation

1. Press NAVI.



The following display appears.

See the pages in [19](#) for details on the features.

e.g. When playing a DVD video disc.

Select by pressing **◀ / ▶** then press **ENTER** to access the feature.

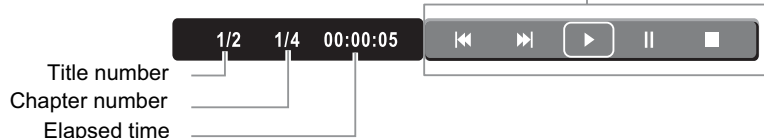

2. To turn off the display, press NAVI again.

Features

Title number (Track number)

Locate a title or track using the number buttons. [20](#)

Chapter number

Locate a chapter using the number buttons. [20](#)

Elapsed time of the current title or track. To enter the time to locate a desired location. [22](#)

■ : To stop playback. [17](#)

◀◀ : Playback starts from the beginning of the current chapter or track. [20](#)

▶ : To start playback. [16](#)

▶▶ : To locate succeeding chapters or tracks. [20](#)

|| : To pause playback. [17](#)

On-screen Display Operation (Continued)

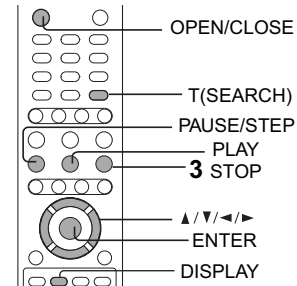

On-screen display operation

■ Viewing the operational status

1 Press **DISPLAY**.
The following display appears.

VCD2.0
Track 2/17
00:00:10 00:04:43

DVD Video
Title 2/3
Audio 1/1 D 2 Ch
Angle 1/1
Chapter 1/1
Subtitle Off
Bitrate 8.448Mbps

Time counter
VCD Elapsed time / remaining time of the current track
DVD Elapsed time / remaining time of the current title

Track List: Track 01 to Track 08

Filter: Repeat: Off, Mode: Normal

Music Playing

2 To turn off the display, press **DISPLAY** again.

Bit Rate (Mbit/s)
Amount of picture, sound and subtitle data in the DVD video disc transferred per second. The larger the value is, the more data processed, but this does not necessarily insure better picture quality.

Advanced playback

Playing MP3/WMA Files

You can play MP3/WMA files that have been recorded on a CD-R or CD-ROM on the DVD video player.

Playing MP3/WMA/ files

■ Preparations

- Make sure that a disc you want to play is compatible with this DVD video player.

1 Place a CD that contains MP3/WMA files on the disc tray.

2 Press **OPEN/CLOSE** to load the disc.

OPEN/CLOSE



3 To stop playback, press **STOP**.

STOP



■ Selecting a specific time of the current track

- 1 Press **T**.
- 2 Enter the time to select a specific time you want to play.
- 3 Press **ENTER** to begin playback of the selected time.

Notes

- Letters of a file/folder name overflowing the given space are not displayed.
- You can play in fast reverse or fast forward during MP3 playback but not WMA playback.



■ To pause playback

Press **PAUSE/STEP** during playback.





PAUSE/STEP To resume normal playback, press the **PLAY** button.



Notes

- Some discs may not permit this operation.
- WMA tracks copy-protected cannot be played.
- The COAXIAL DIGITAL AUDIO OUT jack outputs MP3/WMA sounds in the linear PCM format regardless of the current "Digital Output" selection  .
- The SKIP  functions are also available.

■ Play modes for MP3/WMA/CD/DivX®.

When you play MP3/WMA/CD/DivX®, users are able to modify the Play modes through the Toolkit which appears on the right of below picture on the screen. Press  /  buttons to navigate between the windows and  /  buttons to select files/tracks or play mode items. Then press ENTER button. Please refer to below steps to playback files/tracks in the Memory View list:

- 1) Select Edit Mode in the Toolkit then press ENTER button to start Edit Mode.
- 2) Select a file/track or more files/tracks you want in the Original View list.
- 3) Select Add To Memory in the Toolkit then press ENTER. "✓" will disappear from the screen. It means that the files/tracks you have selected already add into the Memory View list.
- 4) Select Memory View in the Toolkit then press ENTER to open the files/tracks in the Memory View list that you already selected in step 2.
- 5) Press PLAY to playback all files/tracks in the Memory View list.

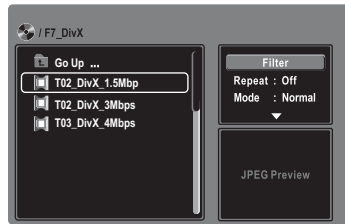

The Toolkit has the following play mode items:

- **Filter (Audio/Photo/Video):** Sets file filters.
- **Repeat (Off/Track/All):**
 - Off : Resumes normal playback.
 - Track : Repeats the current track/file.
 - All : Repeats all files on the current folder or all tracks on the disc.
- **Mode (Normal/Shuffle/Random/Intro):**
 - Normal: Resumes normal playback.
 - Shuffle: Playbacks track/file in random order.
 - Random: Playbacks track/file in random order, and will repeat playback the same track/file more than one time.
 - Intro: Only playbacks the first 10 seconds of all the files on the current folder or all tracks on the disc.
- **Edit Mode:** Memory operation works only when Edit Mode is selected.
- **Memory View:** To view tracks/files in the Memory View list. It is disabled when the Memory View list is empty.
- **Add To Memory:** Add files/tracks to the Memory View list. It is disabled if the Edit Mode is not selected.
- **Browser View :** To view files/tracks in the Original View list.
- **Clear All:** Delete the files/tracks in the Memory View list.

Select a file/track or more you want to delete in stop mode. "✓" will appear beside the deleted file/track. Select Clear All and then press ENTER. It is disabled if the Edit mode is not selected.

■ Playable files

MP3/WMA disc compatibility with this player is limited as follows:

- Playable discs: CD-ROM, CD-R (650MB / 74 min. only)
CD-RW is not recommendable.
- Sampling Frequency: 44.1 kHz only
- Bit rate: WMA: 48 kbps - 192 kbps (CBR*)
MP3: 32 kbps - 320 kbps (CBR*)
- CD physical format: Mode 1, Mode 2 XA Form 1
- File system: ISO9660 Level 1, 2 or Joliet
- File name: A file name should be in alphabet and numerals only, and must incorporate "MP3" or "WMA" extension.
e.g. "*****.MP3", "*****.WMA"
- Total number of folders: Less than 256
- Total number of files: Less than 1000
- WMA codec version: V7 or V8 (Stereo sound only)

* CBR = Constant Bit Rate

This DVD video player requires discs/recordings to meet certain technical standards in order to achieve optimal playback quality. Pre-recorded DVDs are automatically set to these standards. There are many different types of recordable disc formats (including CD-R containing MP3/WMA files). Because this area of technology is still evolving, Toshiba cannot guarantee that all recordable discs will produce optimal playback quality. The technical criteria set forth in this owner's manual are meant only as a guide.

You must obtain any required permission from copyright owners to download to download or use copyrighted content. Toshiba cannot and does not grant such permission.

Microsoft, Windows Media, and the Windows Logo are either registered trademarks or trademarks of Microsoft Corporation in the United States and/or other countries.

**Note**

When the WMA or MP3 file is out of the above specifications, the song may skip or mute with counter moving.

Viewing JPEG Files

You can play JPEG files that have been recorded on a CD-R or CD-ROM on the DVD video player. You can select a preferred view: a page of 9 thumbnail images or a single image view. Also, rotating, enlarging and shifting of each image can be possible.

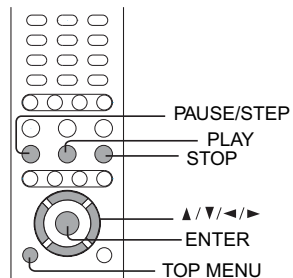

Viewing JPEG files

■ Preparations

- Prepare a disc that contains JPEG files you want to view. (30)
- Make your TV shape conform to the 4:3 picture size. Only 4:3 pictures can be played regardless of the function settings via the on-screen displays of the DVD video player. If the TV is adjusted to other sizes, e.g. "WIDE," images will appear to be horizontally expanded. For details, refer to the owner's manual of your TV.

1 Press OPEN/CLOSE to open the disc tray, place a disc that contains JPEG files.

Press OPEN/CLOSE to close the disc tray. A list of folders/files will appear on the screen.

A list of folders in the disc appears. e.g.

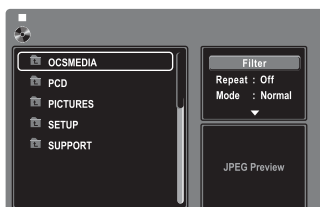

A list of files in the disc appears. (Selection mode) e.g.

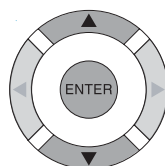
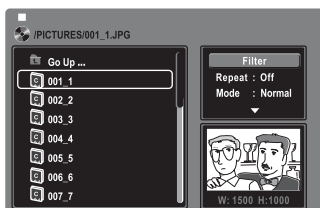

Press ▲ / ▼ to select your desired file, and then press ENTER or PLAY button to start playback. Press STOP to display a folder list.

To change the picture transition mode, see page 25.

Notes

When you press ▲ / ▼ button to select the left file, the selected picture will appear at the lower right corner.

■ To quit the JPEG playback, press STOP.



- Pressing the OPEN/CLOSE button to open the disc tray can also quit the playback.

■ To pause playback

Press PAUSE/STEP during playback



To resume normal playback, press PLAY.

■ To change the image



To view the succeeding image, press SKIP ►►.



To view the previous image, press SKIP ◀◀.

■ To magnify image

Press ZOOM repeatedly.



Each time you press the ZOOM button, the magnification level changes as follows:

Q 1 → Q 2 → Q 3 → Q off

Press the ▲ / ▼ / ◀ / ► buttons to view a different part of the image. You may move the image from the centre position to UP, DOWN, LEFT and RIGHT direction. When you reach the edge of the image, the display will not shift anymore in that direction.

■ To rotate an image

Press the ► repeatedly.

The image rotates by clockwise 90、180、270 degree.

Or Press the ◀ repeatedly.

The image rotates by counter clockwise 270、180、90 degree.

■ To resume normal playback

Press the ZOOM repeatedly until the Q off is displayed.



- Original picture is restored when the Q off appears.
- Depending on the file size, some files may not display the entire image.

Advanced playback

Viewing a thumbnail view

1 Press TOP MENU in full-screen review.

TOP MENU

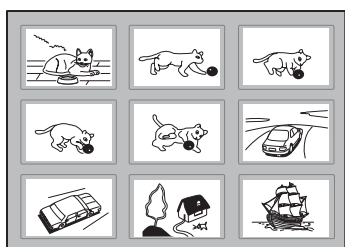

■ Turn the page if necessary

Press SKIP ◀◀ / ►► to review other thumbnail screen.

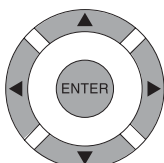

Press the ▲ / ▼ / ◀ / ► to select an image, press PLAY to view one image in full-screen and automatically images will be displayed one by one again in a few seconds.

■ **To quit the JPEG playback, press STOP.**



• Pressing the OPEN/CLOSE button to open the disc tray can also quit the playback.

■ **To pause playback**

Press PAUSE/STEP during playback



To resume normal playback, press PLAY.

Notes

- Depending on the file size, some files may not display the entire image.
- If you press the TOP MENU in full-screen review, the DVD video player will display a menu of 9 thumbnail images.

JPEG files compatibility

Discs whose compatibility with this DVD video player has been confirmed by TOSHIBA are as follows. Many of these discs, when loaded, will make the DVD video player enter the automatic mode to play a prescribed folder in the disc. To play other folders, display a folder list and select a folder.

CANON QuickCD FUJICOLOR CD Kodak Picture CD NORITSU QSS CD

JPEG disc compatibility with this DVD video player is limited as follows:

- Playable discs: CD-ROM, CD-R (650MB / 74 min. only)
CD-RW is not recommendable.
- CD physical format: Mode 1, Mode 2 XA Form 1
- File system: ISO9660 Level 1, 2 or Joliet
- File name: A file name should be in alphabet and numerals only, and must incorporate "JPG" extension.
e.g. "*****.JPG" (Do not name the file with "JPE" or "JPEG" extension.)
- Total number of folders: Less than 256
- Total number of files: Less than 1000

Depending on the file size, some files may not display the entire image.

Some discs may not permit this operation. Especially, the following conditions of included files will increase the disc's disability.

1. Pixels over 3072 x 2048 in height and/or width
2. File format except Exif

Playing DivX® Files

You can play DivX® files that have been recorded on a CD-R or CD-ROM on the DVD video player.

Playing DivX® files

1 Press OPEN/CLOSE to open the disc tray, place a disc that contains DivX® files.



Press OPEN/CLOSE to close the disc tray, after completion of reading, a list of folders in the disc will appear.

A list of folders in the disc appears.

e.g.

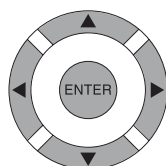
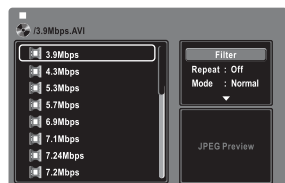

Press ▲ / ▼ to select your desired file, and then press ENTER or PLAY button to start playback.

Press STOP to display the folder list.



Notes

- It is recommended you record same kind of files in a CD-ROM or CD-R.
- Some DivX Video-On-Demand files may require registration code of your DVD video player, you may get the code in Rating settings [37](#).

■ **Playable files**

DivX® disc compatibility with this player is limited as follows:

- Playable discs: CD-ROM, CD-R (650MB / 74 min. only)
CD-RW is not recommendable.
- Audio format: CBR MP3, VBR MP3, DivX® AC3
- Enhance video: GMC, Qpel, Progressive B-frames
- Frame rate: 8 to 25 fps
- CD physical format: Mode 1, Mode 2 X A Form 1
- File system: ISO9660 Level 1, 2 or Joliet
- File name: A file name should be in alphabet and numerals only, and must incorporate "AVI" extension.
e.g. "*****.AVI "
- Total number of folders: Less than 256
- Total number of files: Less than 1000

DivX, DivX Certified, and associated logos are trademarks of DivX, Inc. and used under license.

Function setup

You can change the default settings to customize performance to your preference.

- Customizing the Function Settings
- Table of Languages

Customizing the Function Settings

You can change the default settings to customize performance to your preference.

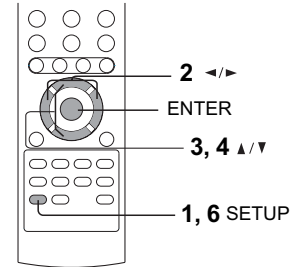

Setting procedure

1 Press SETUP during stop or playback.



The following on-screen display appears.

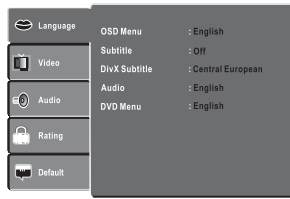

2 Press ▲ / ▼ to select an option for the setting you want to change, then press ►.

(See the next page.)

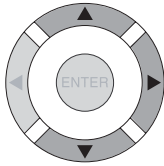

Language settings

Video settings

Audio settings

Rating settings

Default settings

3 Press ▲ / ▼ to select the setting you want to change, then press ENTER.

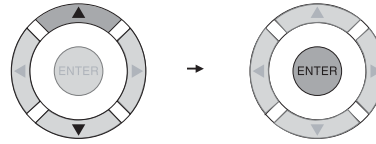

4 Change the selection by ▲ / ▼ buttons, by referring to the corresponding pages, then press ENTER.

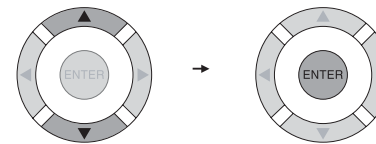

5 Repeat steps 3 and 4 to change other settings.

To select another option, press ◀ to go back to step 2.

6 Press SETUP.



The on-screen display disappears.

Note

To quit the procedure, press the SETUP button to turn off the on-screen display.















Tray Lock

Press SETUP button, and then press the number button 2005 to lock the tray.

Note

After the tray is locked, "Tray Lock Is On" will appear on the screen when OPEN/CLOSE button is pressed.

To unlock the tray, just follow the same procedure as above.

Setting		Details	Page
Language	OSD Menu	 To select a preferred language for on-screen display.	34
	Subtitle	 To select a preferred language for subtitles.	34
	DivX Subtitle	 To select a preferred language for your DivX video disc.	34
	Audio	 To select a preferred language for the sound track.	34
	DVD Menu	 To select a preferred language for disc menus.	34
Video	TV Shape	 To select a picture size according to aspect ratio of your TV.	35
	View Mode	 To select desired view type for 4:3 TV shape.	35
	Video Output	 To select whether you send composite, S-VIDEO Component or progressive signal to the connected TV.	35
	JPEG Interval	Set succeeding playback's interval of JPEG file.	35
Audio	Digital Output	 To select an output sound format corresponding to your system connection.	36
	Night Mode	 To enable and disable the Night Mode.	36
Rating	Parental	 To turn the parental lock function on or off.	36
	Set Password	 To set the password.	36
Default	Use Default Settings	 To return the initial settings such as Language, Video, Audio and etc. to the factory default.	37
	DivX Registration	 To get your DVD Video Player DivX registration code.	37

Customizing the Function Settings (continued)

Setting details

Language

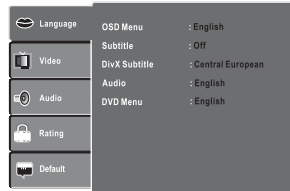

OSD Menu

DVD VCD CD

English: To view on-screen displays in English.
 Français: To view on-screen displays in French.
 Español: To view on-screen displays in Spanish.

- 1) Press SETUP button.
- 2) Press ► button to select the OSD Menu.
- 3) Press ENTER button, then the ▲ / ▼ button to shift and change the Language.
- 4) Press ENTER button .
- 5) Press SETUP to exit the menu.

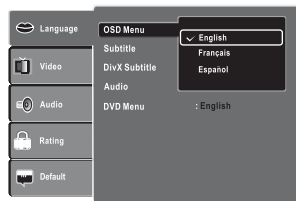

Subtitle

DVD

English: To display subtitles in English.
 Français: To display subtitles in French.
 Español: To display subtitles in Spanish.
 Auto: To display subtitles in different languages other than you selected.
 Off: To disable subtitles.

- 1) Press SETUP button.
- 2) Press ► button, then the ▲ / ▼ button to shift to select the Subtitle.
- 3) Press ENTER button, then the ▲ / ▼ button to shift and change the Language.
- 4) Press ENTER button .
- 5) Press SETUP to exit the menu .

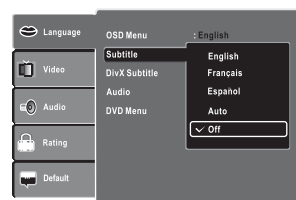

Notes

- Some DVD video discs may be set to display subtitles in a different language other than you selected. A prior subtitle language may be programmed on the disc.
- Some DVD video discs allow you to change subtitle selections only via the disc menu. If this is the case, press the MENU button and choose the appropriate subtitle language from the selection on the disc menu.

DivX Subtitle

DVD

If your DivX files include a subtitle file, then you may select a supported DivX subtitle language by region :

Standard: Albanian, Danish, Dutch, English, Finnish, French, Gaelic, German, Italian, Kurdish (Latin), Norwegian, Portuguese, Spanish, Swedish and Turkish
 Central European: Albanian, Croat, Czech, Dutch, English, German, Hungarian, Irish, Polish, Romanian, Slovak, Slovene and Serbian
 Cyrillic: Bulgarian, Belorussian, English, Macedonian, Moldavian, Russian, Serbian and Ukrainian

- 1) Press SETUP button.
- 2) Press ► button, then the ▲ / ▼ button to select the DivX Subtitle.
- 3) Press ENTER button, then the ▲ / ▼ button again until your preferred subtitle is displayed.
- 4) Press ENTER button .
- 5) Press SETUP to exit the menu.

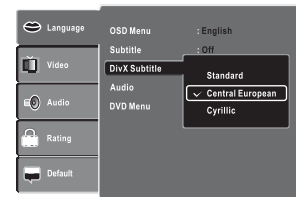

Notes

- If your DivX files do not include the subtitle file, you cannot use this selection.
- Supported subtitle file formats: .srt, .sub, .txt, .smi, .ssa, .ass, .psb.

Audio

DVD

English: To play sound tracks in English.
 Français: To play sound tracks in French.
 Español: To play sound tracks in Spanish.

- 1) Press SETUP button.
- 2) Press ► button, then the ▲ / ▼ button to select the Audio.
- 3) Press ENTER button, then the ▲ / ▼ button to shift and change the Language.
- 4) Press ENTER button .
- 5) Press SETUP to exit the menu.

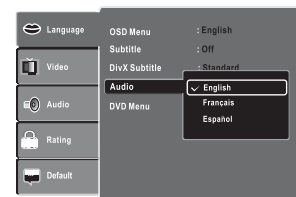

Note

Some DVD video discs may not be played in a different language that you selected. A prior language may be programmed on the disc.

DVD Menu

DVD

English: To display DVD menus in English.
 Français: To display DVD menus in French.
 Español: To display DVD menus in Spanish.

- 1) Press SETUP button.
- 2) Press ► button, then the ▲ / ▼ button to select the DVD menu.
- 3) Press ENTER button, then the ▲ / ▼ button to shift and change the Language.
- 4) Press ENTER button .
- 5) Press SETUP to exit the menu.

Note

Some DVD video discs may not include your pre-selected language. In this case, the DVD video player automatically displays disc menus consistent with the disc's initial language setting.

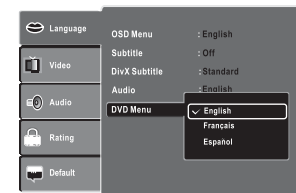

Customizing the Function Settings (continued)

Setting details

Video

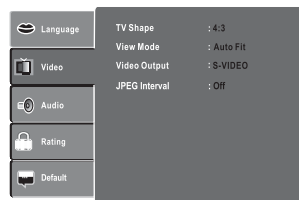

TV Shape



- 1) Press SETUP button.
- 2) Press ▲ / ▼ button to select the Video.
- 3) Press ► button, then the ▲ / ▼ button to select the TV Shape.
- 4) Press ENTER button, then the ▲ / ▼ button to shift and change the TV type.
- 5) Press ENTER button .
- 6) Press SETUP to exit the menu.

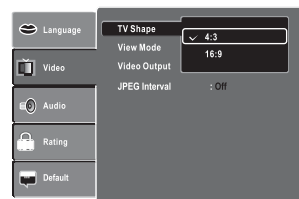

4:3



Select when a standard 4:3 TV is connected. Displays pictures cropped to fill your TV screen. Either or both sides of the picture are cut off.

16:9

Select when a 16:9 TV is connected.

Notes

- The displayable picture size is preset on the DVD video disc. Therefore, the playback picture of some DVD video discs may not conform to the picture size you select.
- When you play DVD video discs recorded in the 4:3 picture size only, the playback picture always appears in the 4:3 picture size regardless of the TV shape setting.
- If you select "16:9" and you own a 4:3 TV set, the DVD playback picture will be horizontally distorted during playback. Images will appear to be horizontally compressed. Always be sure that your TV shape conforms to the actual TV in use.

View Mode



The user may select one of the following options:

- Fill: Fill the screen with decoded image.
 Original: Display image as its original size.
 Height Fit: Fit the screen height with image height.
 Width Fit: Fit the screen width with image width.
 Auto Fit: Automatically fit the decoded image on screen without distortion.
 Pan Scan: Automatically display decoded image on full screen without distortion.

- 1) Press SETUP button.
- 2) Press ▲ / ▼ button to select the Video Mode.
- 3) Press ► button, then the ▲ / ▼ button to select the View Mode.
- 4) Press ENTER button, then the ▲ / ▼ button to shift and change the View Mode.
- 5) Press ENTER button .
- 6) Press SETUP to exit the menu.

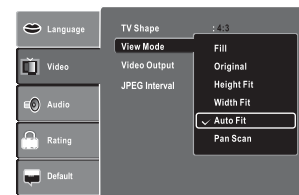

Pan Scan



Select when a standard 4:3 TV is connected. Displays pictures cropped to fill your TV screen. Either or both sides of the picture are cut off.

Auto Fit



Automatically fit the decoded image on screen without distortion. Black bars will be present on top/bottom or left/ right of screen.

Note

Depending on the DVD discs, you may not be able to view the mode as selected.

Video Output



- 1) Press SETUP button.
- 2) Press ▲ / ▼ button to select the Video
- 3) Press ► button, then the ▲ / ▼ button to select the Video Output.
- 4) Press ENTER button, then the ▲ / ▼ button to select the output mode.
- 5) Press ENTER button .
- 6) Press SETUP to exit the menu.

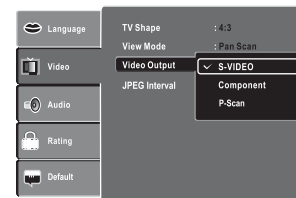

S-VIDEO: Select if you connect the DVD to TV via composite video (yellow) input or S-VIDEO input.

Component: Select if you connect the DVD to your TV which has component video inputs.

P-Scan: Select if you connect the DVD to your TV which has component video inputs that support progressive scan.

If your TV does not support progressive scan, distorted picture or blank screen will appear when " Yes " option is selected.

In this case, just wait for 15 seconds for auto recovery.

Note

At Component and Progressive mode, there is no S-VIDEO output.

JPEG Interval

- Off:** Plays back one file at a time.
5 Seconds: Plays back images in the form of a slide show at 5 second intervals.
10 Seconds: Plays back images in the form of a slide show at 10 second intervals.
15 Seconds: Plays back images in the form of a slide show at 15 second intervals.

- 1) Press SETUP button.
- 2) Press ▲ / ▼ button to select the Video.
- 3) Press ► button, then the ▲ / ▼ button to select the JPEG Interval.
- 4) Press ENTER button, then the ▲ / ▼ button to shift and change the JPEG Interval.
- 5) Press ENTER button .
- 6) Press SETUP to exit the menu.

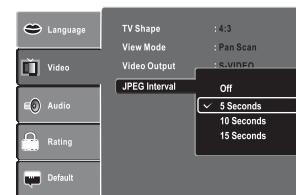

Customizing the Function Settings (continued)

Setting details

Audio

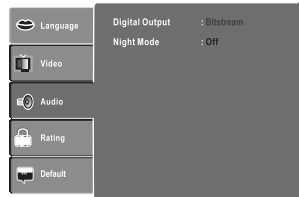

Digital Output (DVD VCD CD)

Selected the output sound format corresponding to your system connection.

- 1) Press SETUP button.
- 2) Press ▲ / ▼ button to select the Audio.
- 3) Press ► button, then the ▲ / ▼ button to select the Digital Output.
- 4) Press ENTER button, then the ▲ / ▼ button to shift and change the output sound format.
- 5) Press ENTER button .
- 6) Press SETUP to exit the menu.

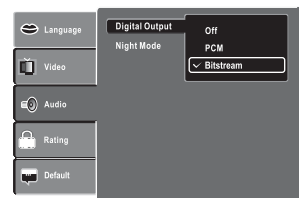

Off: No digital audio will be output.

PCM: Select when connected to a 2 channel digital stereo amplifier.

The DVD video player outputs sounds in the PCM 2 channel format when you play a DVD video disc recorded on the Dolby Digital, MPEG1 OR MPEG2 recording system.

Bitstream: Disc audio raw data will be output.

Note

When you make a connection to a TV, or Dolby Surround Pro Logic or stereo system via the analog audio jacks, select "PCM" or "Bitstream".

Night Mode (DVD VCD CD)

Night Mode is called Dynamic Range Compress. When it is on, it reduces the variations between loud and soft sounds in audio output. You can still hear softer sounds and dialogue even in very low volume.

- 1) Press SETUP button.
- 2) Press ▲ / ▼ button to select the Audio.
- 3) Press ► button, then the ▲ / ▼ button to select the Night Mode.
- 4) Press ENTER button, then the ▲ / ▼ button to shift and change the Night Mode.
- 5) Press ENTER button .
- 6) Press SETUP to exit the menu.

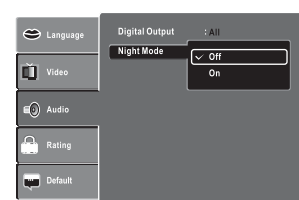

Note

Night mode is Dynamic Range Control (DRC) option for analog audio output.

Rating

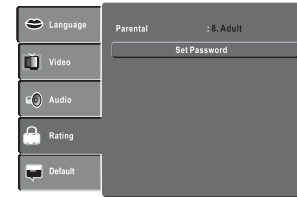

Parental (DVD)

DVD discs equipped with the password function are rated according to their content. The contents allowed by a parental lock level and the way a DVD disc can be controlled may vary from disc to disc.

For example, if the disc allowed, you could edit out violent scenes unsuitable for children and replace them with more suitable scenes, or you could lock out playback of the disc altogether.

• DVD video discs may or may not respond to the parental lock settings. This is not a defect in the DVD video player. Make sure this function works with your DVD video discs.

- 1) Press SETUP button.
- 2) Press ▲ / ▼ button to select the Rating.
- 3) Press ► button, then the ENTER button to select the Parental. "Enter Password" will appear.
- 4) Press "8888" using number buttons. (Please note, this is pre-setting password of this unit), Then press ENTER. Press ENTER again to list the parental level.

The parental lock level is equivalent to the following

Parentals:

- Level 1: Kid Safe
- Level 2: G
- Level 3: PG
- Level 4: PG-13
- Level 5: PG-R
- Level 6: R
- Level 7: NC-17
- Level 8: Adult

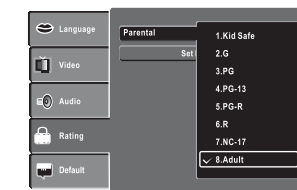

- 5) Press ▲ / ▼ to select the rating from 1 to 8. Rating one (1) has the most restrictions while rating eight(8) can virtually playback all DVD software.
- 6) Press OPEN/CLOSE button to activate the Parental Level setting. If the DVD disc has been designed to temporarily cancel the Parental Level, the screen will change depending on which disc is played. If you select " YES " with the ENTER button, " Enter Password " screen will appear. Input the 4- digit password as you have set followed by ENTER button and playback will start. If " NO " is selected, press the OPEN/ CLOSE to remove the disc.

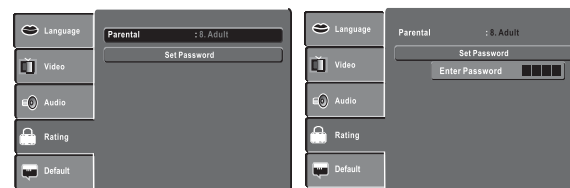

Notes

- If you make a mistake before pressing ENTER button, press CLEAR button and enter your 4-digit security code again.
- You cannot play DVD discs rated higher than the level you selected unless you cancel the parental lock function.

Set Password DVD

New Password can be set to replace the default password.

- 1) Press SETUP button.
- 2) Press ▲ / ▼ button to select the Rating.
- 3) Press ► button, then the ▲ / ▼ button to select Set Password.
- 4) Press ENTER button, "Enter Password" will appear.
- 5) Press number button to input the current password (If the password has not been set yet after you purchase this unit, it is "8888"). Then press ENTER.
- 6) Press ENTER button again, "Enter New Password" will appear. Press number buttons to input the new password.
- 7) Press ENTER button. Now your new password has been set. Be sure to remember this number!

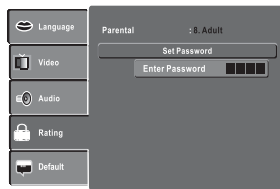

If you forget the password, you can erase your current password by pressing number button 8 on the remote four times, then press ENTER button to confirm the setting.
PASSWORD: 8888

Default

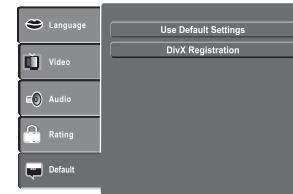

Use Default Settings DVD VCD CD

If you want to return the initial language setting such as Language, Video, Audio and etc. to the factory default, do the following:

- 1) Press SETUP button.
- 2) Press ▲ / ▼ button to select the Misc.
- 3) Press ► button, then the ENTER button to select the Use Default Settings dialog box.
- 4) Press ◀ / ▶ button to select Yes, then press ENTER button. The original setting will be restored.
- 5) Press SETUP to exit the menu.

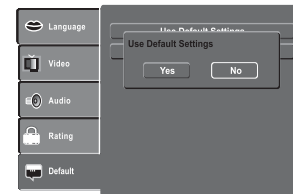

Note

When you reset the DVD video player to the factory default, the DVD video player will take 3-5 seconds to reset.

DivX Registration DVD

Some DivX Video-On-Demand files required registration code, please get the code of your DVD video player as follow:

- 1) Press SETUP button.
- 2) Press ▲ / ▼ button to select the Misc.
- 3) Press ► button, then the ▲ / ▼ button to select the DivX Registration.
- 4) Press ENTER button, your registration code will be shown.
- 5) Press ENTER button.
- 6) Press SETUP to exit the menu.

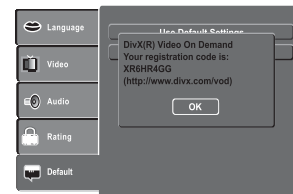

Note

This registration code is for DivX Video-On-Demand only, do not apply this code for other applications or websites.

Table of Languages

Table of languages and their abbreviations

Abbreviation	Language	Abbreviation	Language	Abbreviation	Language
---	No alternate language	GN	Guarani	PT	Portuguese
CHI (ZH)	Chinese	GU	Gujarati	QU	Quechua
DUT (NL)	Dutch	HA	Hausa	RM	Rhaeto-Romance
ENG (EN)	English	HI	Hindi	RN	Kirundi
FRE (FR)	French	HR	Croatian	RO	Rumanian
GER (DE)	German	HU	Hungarian	RU	Russian
ITA (IT)	Italian	HY	Armenian	RW	Kinyarwanda
JPN (JA)	Japanese	IA	Interlingua	SA	Sanskrit
KOR (KO)	Korean	IE	Interlingue	SD	Sindhi
MAY (MS)	Malay	IK	Inupiak	SG	Sango
SPA (ES)	Spanish	IN	Indonesian	SH	Serbo-Croatian
AA	Afar	IS	Icelandic	SI	Singhalese
AB	Abkhazian	IW	Hebrew	SK	Slovak
AF	Afrikaans	JI	Yiddish	SL	Slovenian
AM	Amharic	JW	Javanese	SM	Samoan
AR	Arabic	KA	Georgian	SN	Shona
AS	Assamese	KK	Kazakh	SO	Somali
AY	Aymara	KL	Greenlandic	SQ	Albanian
AZ	Azerbaijani	KM	Cambodian	SR	Serbian
BA	Bashkir	KN	Kannada	SS	Siswati
BE	Belorussian	KS	Kashmiri	ST	Sesotho
BG	Bulgarian	KU	Kurdish	SU	Sundanese
BH	Bihari	KY	Kirghiz	SV	Swedish
BI	Bislama	LA	Latin	SW	Swahili
BN	Bengali, Bangla	LN	Lingala	TA	Tamil
BO	Tibetan	LO	Laotian	TE	Telugu
BR	Breton	LT	Lithuanian	TG	Tajik
CA	Catalan	LV	Latvian, Lettish	TH	Thai
CO	Corsican	MG	Malagasy	TI	Tigrinya
CS	Czech	MI	Maori	TK	Turkmen
CY	Welsh	MK	Macedonian	TL	Tagalog
DA	Danish	ML	Malayalam	TN	Setswana
DZ	Bhutani	MN	Mongolian	TO	Tongan
EL	Greek	MO	Moldavian	TR	Turkish
EO	Esperanto	MR	Marathi	TS	Tsonga
ET	Estonian	MT	Maltese	TT	Tatar
EU	Basque	MY	Burmese	TW	Twi
FA	Persian	NA	Nauru	UK	Ukrainian
FI	Finnish	NE	Nepali	UR	Urdu
FJ	Fiji	NO	Norwegian	UZ	Uzbek
FO	Faroese	OC	Occitan	VI	Vietnamese
FY	Frisian	OM	(Afan) Oromo	VO	Volapük
GA	Irish	OR	Oriya	WO	Wolof
GD	Scottish Gaelic	PA	Panjabi	XH	Xhosa
GL	Galician	PL	Polish	YO	Yoruba
		PS	Pashto, Pushto	ZU	Zulu

Others

- Before Calling Service Personnel
- Specifications
- United States Warranty

Before Calling Service Personnel

Check the following guide for the possible cause of a problem before contacting service.

Symptoms and correction

Symptom	Cause	Correction	Page
No power.	<ul style="list-style-type: none"> The power plug is disconnected. 	<ul style="list-style-type: none"> Connect the power plug securely into the wall outlet. 	12,13
The DVD video player turned off by itself.	<ul style="list-style-type: none"> The automatic power off function turned the unit off. 	<ul style="list-style-type: none"> Press the PLAY button. 	17
No picture or abnormal colour (pinkish, greenish, etc.).	<ul style="list-style-type: none"> The TV is not set to receive DVD signal output. 	<ul style="list-style-type: none"> Select the appropriate video input mode on the TV so the picture from the DVD video player appears on the TV screen. 	12,16
	<ul style="list-style-type: none"> The video cable is not connected securely. 	<ul style="list-style-type: none"> Connect the video cable securely into the appropriate jacks. 	12,13
	<ul style="list-style-type: none"> Mismatch setting between TV and this unit. 	<ul style="list-style-type: none"> Select the correct Video Output setting. 	35
	<ul style="list-style-type: none"> Wrong connection. 	<ul style="list-style-type: none"> Check the connection. 	12,13
No sound.	<ul style="list-style-type: none"> PROGRESSIVE button pressed on a TV equipped with component video input jacks but does not support progressive scan. 	<ul style="list-style-type: none"> Toggle PROGRESSIVE button to turn off progressive mode. 	13
	<ul style="list-style-type: none"> The equipment connected with the audio cable is not set to receive DVD signal output. 	<ul style="list-style-type: none"> Select the correct input mode of the audio receiver so you can listen to the sound from the DVD video player. 	12,16
	<ul style="list-style-type: none"> The audio cable is not connected securely. 	<ul style="list-style-type: none"> Connect the audio cable securely into the appropriate jacks. 	12-14
	<ul style="list-style-type: none"> The audio receiver or TV is turned off. 	<ul style="list-style-type: none"> Turn on the equipment connected with the audio cable. 	16
The playback picture has occasional distortion.	<ul style="list-style-type: none"> The setting of output sound format is incorrect. 	<ul style="list-style-type: none"> Select the proper audio setting. 	26,32,36
	<ul style="list-style-type: none"> The disc is dirty. 	<ul style="list-style-type: none"> Eject the disc and clean it. 	5
The playback picture has occasional distortion.	<ul style="list-style-type: none"> It is in fast forward or fast reverse playback. 	<ul style="list-style-type: none"> Sometimes a small amount of picture distortion may appear. This is not a malfunction. 	-
	<ul style="list-style-type: none"> The effect of copy protection. 	<ul style="list-style-type: none"> Connect the DVD video player directly to the TV. Avoid connecting the DVD video player to a VCR or TV/VCR combination. 	12
The DVD video player does not start playback.	<ul style="list-style-type: none"> No disc is inserted. 	<ul style="list-style-type: none"> Insert a disc. 	16
	<ul style="list-style-type: none"> An unplayable disc is inserted. 	<ul style="list-style-type: none"> Insert a playable disc. (Check the disc type and color system.) 	6
	<ul style="list-style-type: none"> The disc is placed upside down. 	<ul style="list-style-type: none"> Place the disc with the playback side down. 	16
	<ul style="list-style-type: none"> The disc is not placed within the guide. 	<ul style="list-style-type: none"> Place the disc correctly inside the guide on the disc tray. 	16
	<ul style="list-style-type: none"> The disc is dirty. 	<ul style="list-style-type: none"> Clean the disc. 	5
The DVD video player does not start playback.	<ul style="list-style-type: none"> The parental lock function is set. 	<ul style="list-style-type: none"> Cancel the parental lock function or change the parental lock level. 	32,36
	<ul style="list-style-type: none"> It is in the mode of repeat playback, memory playback, etc. 	<ul style="list-style-type: none"> These operations may prevent a proper progress of the contents. 	-
Buttons do not work.	<ul style="list-style-type: none"> Power supply fluctuations or other abnormalities such as static electricity may interrupt correct operations. 	<ul style="list-style-type: none"> Press and hold the ON/STANDBY button on the front panel for more than about 3 seconds. The DVD video player turns off. Press the button again to turn it on. If the buttons still do not work, disconnect the power plug and insert it into the wall outlet again. 	-
The remote control does not work properly.	<ul style="list-style-type: none"> The remote control is not pointed at the remote sensor of the DVD video player. 	<ul style="list-style-type: none"> Point the remote control at the remote sensor of the DVD video player. 	10
	<ul style="list-style-type: none"> The remote control is too far from the DVD video player. 	<ul style="list-style-type: none"> Operate the remote control within about 7 m. 	10
	<ul style="list-style-type: none"> The batteries in the remote control are exhausted. 	<ul style="list-style-type: none"> Replace the batteries with new ones. 	10
The logo and playing picture of DVD player become poor.	<ul style="list-style-type: none"> Adjust sharpness too small or too large. 	<ul style="list-style-type: none"> Adjust Brightness or sharpness to a certain level 	24
The DVD player tray does not open	<ul style="list-style-type: none"> Tray Lock mode has been enable. 	<ul style="list-style-type: none"> Disable the Tray Lock function 	32

Specifications

DVD Video player/outputs/supplied accessories

DVD Video player

Power supply	120 V AC, 60 Hz
Power consumption	13 W
Mass	1.6 kg
External dimensions	430 x 42 x 198 mm (W/H/D)
Signal system	Standard NTSC
Laser	Semiconductor laser, wavelength 650/780 nm
Frequency range	DVD linear sound : 48 kHz sampling 4 Hz to 22 kHz 96 kHz sampling 4 Hz to 44 kHz
Signal-to-noise ratio	More than 100 dB
Audio dynamic range	More than 93 dB
Harmonic distortion	Less than -70dB
Wow and flutter	Below measurable level (less than ± 0.001 % (W.PEAK))
Operating conditions	Temperature: 5 °C to 35 °C, Operation status: Horizontal

Outputs

Video output	1.0 V (p-p), 75 Ω , negative sync., pin jack x 1
S video output	(Y) 1.0 V (p-p), 75 Ω , negative sync., Mini DIN 4-pin x 1 (C) 0.286 V (p-p), 75 Ω
Component video output	(Y) 1.0 V (p-p), 75 Ω , negative sync., pin jack x 1 (P _B)/(P _R) 0.7 V (p-p), 75 Ω , pin jack x 2
Audio output (COAXIAL DIGITAL)	0.5V (p-p), 75 Ω , pin jack x 1
Audio output (ANALOG)	2.0 V (rms), 680 Ω , pin jacks (L, R) x 1

Supplied Accessories

Audio/video cable	1
Remote control (SE-R0213)	1
Batteries (AAA)	2

- This model complies with the above specifications.
- Designs and specifications are subject to change without notice.
- This model may not be compatible with features and/or specifications that may be added in the future.

Others

Limited United States Warranty DVD Players - Exchange Warranty

Toshiba America Consumer Products, L.L.C. ("TACP") makes the following limited warranties to original consumers in the United States. THESE LIMITED WARRANTIES EXTEND TO THE ORIGINAL CONSUMER PURCHASER OR ANY PERSON RECEIVING THIS DVD PLAYER AS A GIFT FROM THE ORIGINAL CONSUMER PURCHASER AND TO NO OTHER PURCHASER OR TRANSFEREE.

PRODUCTS PURCHASED IN THE U.S.A. AND USED ANYWHERE OUTSIDE OF THE U.S.A., INCLUDING, WITHOUT LIMITATION, CANADA AND MEXICO, ARE NOT COVERED BY THESE WARRANTIES.

PRODUCTS PURCHASED ANYWHERE OUTSIDE OF THE U.S.A., INCLUDING, WITHOUT LIMITATION, CANADA AND MEXICO, AND USED IN THE U.S.A., ARE NOT COVERED BY THESE WARRANTIES.

Limited Ninety (90) Day Warranty

TACP warrants this DVD Player and its parts against defects in materials or workmanship for period of ninety (90) days after the date of original retail purchase.

DURING THE FIRST NINETY (90) DAYS AFTER THE DATE OF ORIGINAL RETAIL PURCHASE, TACP WILL EXCHANGE A DEFECTIVE DVD PLAYER WITH A NEW OR REFURBISHED DVD PLAYER WITHOUT CHARGE TO YOU. YOU MUST CONTACT TACP'S CONSUMER SOLUTIONS CENTER FOR INSTRUCTIONS ON HOW TO PROCESS YOUR IN WARRANTY EXCHANGE REQUEST. THE CONSUMER IS RESPONSIBLE FOR ALL INBOUND TRANSPORTATION AND INSURANCE CHARGES FOR THE DVD PLAYER TO THE EXCHANGE CENTER. DURING THE PERIOD THAT COMMENCES ON THE DATE THAT IS NINETY ONE (91) DAYS AFTER THE DATE OF ORIGINAL RETAIL PURCHASE AND BEYOND, TACP WILL EXCHANGE A DEFECTIVE DVD PLAYER WITH A NEW OR REFURBISHED DVD PLAYER FOR A NOMINAL FEE. YOU MUST CONTACT TACP'S CONSUMER SOLUTIONS CENTER FOR INSTRUCTIONS ON HOW TO PROCESS YOUR EXCHANGE REQUEST. THE CONSUMER IS RESPONSIBLE FOR ALL INBOUND TRANSPORTATION AND INSURANCE CHARGES FOR THE DVD PLAYER TO THE EXCHANGE CENTER.

Rental Units

The warranty for rental units begins with the first rental or thirty (30) days after the date of shipment to the rental firm, whichever comes first.

Commercial Units

DVD Players sold and used for commercial purposes have a limited ninety (90) day warranty for all parts and labor.

Owner's Manual and Product Registration Card

Read this owner's manual thoroughly before operating this DVD Player. Complete and mail the enclosed product registration card or register your product on-line at www.tacp.toshiba.com/service as soon as possible. By registering your DVD Player you will enable TACP to bring you new products specifically designed to meet your needs and help us to contact you in the unlikely event that a safety notification is required under the Consumer Product Safety Act. Failure to complete and return the product registration card does not diminish your warranty rights.

Your Responsibility

THE ABOVE WARRANTIES ARE SUBJECT TO THE FOLLOWING CONDITIONS:

- (1) You must retain your bill of sale or provide other proof of purchase.
- (2) All warranty servicing of this product must be made by an Authorized TACP Service Station.
- (3) The warranties from TACP are effective only if the product is purchased and operated in the Continental U.S.A. or Puerto Rico.
- (4) Labor service charges for set installation, setup, adjustment of customer controls and installation or repair of antenna systems are not covered by this warranty. Reception problems caused by inadequate antenna systems are your responsibility.
- (5) Warranties extend only to defects in materials or workmanship as limited above, and do not extend to any DVD Player or parts that have been lost or discarded by you or to damage to the DVD Player or parts caused by fires, misuse, accident, Acts of God (such as lightning or fluctuations in electric power), improper installation, improper maintenance, or use in violation of instructions furnished by TACP; use or malfunction through simultaneous use of this product and connected equipment; or to units that have been modified or had the serial number removed, altered, defaced, or rendered illegible.

How to Obtain Warranty Services

If, after following all of the operating instructions in this manual and checking the section "Troubleshooting," you found that service is needed:

- (1) For instructions on how to obtain warranty service for exchange program DVD Players, contact TACP's Call Center toll free at 1-866-583-7353.
- (2) You must include the original bill of sale (or a copy of the original bill of sale) or other proof of purchase along with the entire DVD Player when sending the DVD Player to the Authorized TACP Service Station specified by TACP's Call Center. You must pay for all transportation and insurance charges for the DVD Player to and from the Authorized TACP Service Station.

For additional information, visit TACP's website:
www.tacp.toshiba.com

ALL WARRANTIES IMPLIED BY THE LAW OF ANY STATE OF THE U.S.A., INCLUDING THE IMPLIED WARRANTIES OF MERCHANTABILITY AND FITNESS FOR A PARTICULAR PURPOSE, ARE EXPRESSLY LIMITED TO THE DURATION OF THE LIMITED WARRANTIES SET FORTH ABOVE. WITH THE EXCEPTION OF ANY WARRANTIES IMPLIED BY THE LAW OF ANY STATE OF THE U.S.A. AS HEREBY LIMITED, THE FOREGOING WARRANTY IS EXCLUSIVE AND IN LIEU OF ALL OTHER WARRANTIES, GUARANTEES, AGREEMENTS, AND SIMILAR OBLIGATIONS OF TACP WITH RESPECT TO THE REPAIR OR REPLACEMENT OF ANY PARTS. IN NO EVENT SHALL TACP BE LIABLE FOR CONSEQUENTIAL OR INCIDENTAL DAMAGES (INCLUDING, BUT NOT LIMITED TO, LOST PROFITS, BUSINESS INTERRUPTION, OR MODIFICATION OR ERASURE OF RECORDED DATA CAUSED BY USE, MISUSE OR INABILITY TO USE THIS PRODUCT).

No person, agent, distributor, dealer or company is authorized to change, modify or extend the terms of these warranties in any manner whatsoever. The time within which an action must be commenced to enforce any obligation of TACP arising under the warranty or under any statute, or law of the United States or any state thereof, is hereby limited to ninety (90) days from the date you discover or should have discovered, the defect. This limitation does not apply to implied warranties arising under state law.

THIS WARRANTY GIVES YOU SPECIFIC LEGAL RIGHTS AND YOU MAY ALSO HAVE OTHER RIGHTS WHICH MAY VARY FROM STATE TO STATE IN THE U.S.A. SOME STATES OF THE U.S.A. DO NOT ALLOW LIMITATIONS ON HOW LONG AN IMPLIED WARRANTY LASTS, WHEN AN ACTION MAY BE BROUGHT, OR THE EXCLUSION OR LIMITATION OF INCIDENTAL OR CONSEQUENTIAL DAMAGES, SO THE ABOVE PROVISIONS MAY NOT APPLY TO YOU UNDER SUCH CIRCUMSTANCES.

TOSHIBA



**- IMPORTANT -
CANADIAN WARRANTY INFORMATION**

STANDARD WARRANTY
TYPE OF SET

DVD Player
DVD/VCR Combination
Home Theatre in a Box
DVD Recorder
Portable DVD

WARRANTY PERIOD

12 MONTHS

CANADIAN WARRANTY

Toshiba of Canada Limited (TCL) makes the following limited warranties to original consumers in Canada. Please retain your "Bill of Sale" as proof of purchase. **To obtain a "Canadian Warranty" please register online at www.toshiba.ca.**

Canadian Warranty Information

Should service be required on this unit during the one year warranty period, TCL's option will be to repair or exchange the defective unit. It will be necessary to follow this procedure:

Contact: Toshiba of Canada Limited at the Consumer Electronics Group, customer support line.

Phone: 1-800-268-3404

Email: ceg_customer_support@toshiba.ca

All in-warranty repairs must be made by an authorized TCL service centre.

For service exchange TCL will arrange to have the unit picked up by courier and a replacement unit will be returned via same courier. (Note: A major credit card number will be required as a charge of \$25.00 will apply if no fault is found with the unit.) During the first 3 months of ownership, a new unit will be supplied as a replacement. During the remainder of the warranty period a service-renewed unit will be supplied.

The original "Bill of Sale" must be provided as proof of purchase (it will be returned with the replacement unit.)

This 12-month warranty will be strictly adhered to.

Out of warranty units should be repaired by a TCL authorized service centre.

Note: It is the responsibility of the owner to ensure proper packaging. Should damage in shipping occur, due to poor packaging, a charge back for the repair will result. This warranty applies to the original purchaser only and is not transferable.

This warranty does not apply to sets that have been subjected to misuse, neglect, accident, physical damage or acts of nature.

Sets with the serial number removed, altered, replaced or defaced will not be covered by this warranty.

The warranties from TCL are effective only if the product is purchased in Canada from an authorized TCL dealer and operated in Canada.

Products utilized for rental or commercial purposes are not covered by this warranty.

This warranty is in lieu of all other warranties, guaranties or agreements, whether expressed or implied, and no person, agent distributor, dealer, service centre or company is author-

Toshiba of Canada Limited 191 McNabb Street Markham, Ontario L3R 8H2

TOSHIBA



Printed in China
TSDAC10015B