

EXILIM

E

Digital Camera

EX-S770D

User's Guide

Thank you for purchasing this CASIO product.

- Before using it, be sure to read the precautions contained in this User's Guide.
- Keep the User's Guide in a safe place for future reference.
- For the most up-to-date information about this product, visit the official EXILIM Website at <http://www.exilim.com/>.

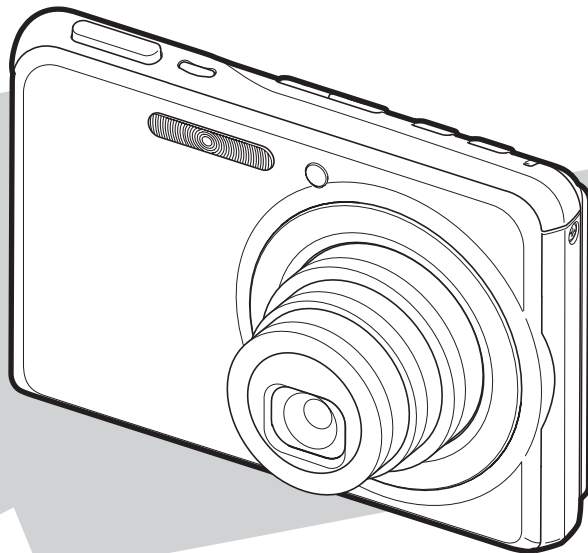

K837PCM2DMX

CASIO®

UNPACKING

As you unpack your camera, check to make sure that all items shown below are included. If anything is missing, contact your original retailer.



Digital Camera

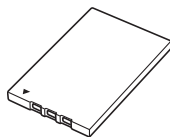

Rechargeable Lithium Ion Battery
(NP-20)

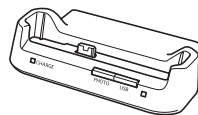

USB Cradle (CA-34)

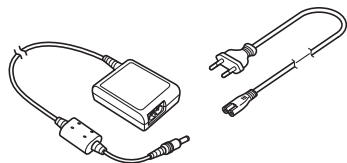

* The shape of the AC power cord plug varies according to country or geographic area.

Special AC Adaptor (AD-C52S or AD-C52G)/AC Power Cord*



To attach the strap to the camera.

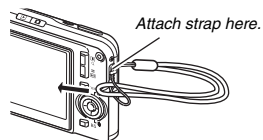

Strap



CD-ROM

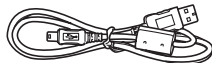

USB Cable

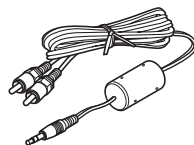

AV Cable



Basic Reference

CONTENTS

UNPACKING 2

QUICK START BASICS 10

First, charge the battery	10
Configuring Display Language, Date, and Time Settings	12
Using a Memory Card	14
Shooting a Snapshot	16
Viewing Snapshots	18
Shooting a Movie	19
Viewing a Movie	20
Deleting a File	21

INTRODUCTION 22

Features	22
Read this first!	24
Precautions during Use	27

GETTING READY 37

Charging the Battery	37
■ To load the battery	37
■ To charge the battery	38
■ Replacing the Battery	42
■ Battery Precautions	42
Turning Power On and Off	43
Using a Memory Card	46
■ Loading a Memory Card into the Camera	48
■ Replacing the Memory Card	49
■ Formatting a Memory Card	50
Using On-screen Menus	52
■ Configuring Monitor Screen Settings	53
■ Selecting a Screen Layout (Layout)	54
■ Turning Display Information On and Off (Info.)	57
■ Adjusting Monitor Screen Brightness (Brightness)	59
■ Adjusting Monitor Screen Image Quality (Type)	60
If you lose your way... ..	61
Using the Camera on a Trip	62
■ Extra Batteries	62
■ Using the Camera in another Country	62

SHOOTING A SNAPSHOT 63

Holding the Camera Correctly	63
Shooting a Snapshot	64
■ Specifying Image Size	67
■ Specifying Image Quality	69
■ Turning Off the AF Assist Lamp	70
■ Snapshot Shooting Precautions	71
■ Auto Focus Restrictions	72
Shooting with Zoom	72
Using Flash	76
Using the Self-Timer	81
Using Continuous Shutter	83
■ Selecting the Continuous Shutter Mode	83
■ Recording with Normal-speed Continuous Shutter, High-speed Continuous Shutter, and Flash Continuous Shutter	84
■ Recording with Zoom Continuous Shutter	84
■ Continuous Shutter Precautions	85
Adding Audio to a Snapshot	86

SHOOTING A MOVIE 89

Movie Image Quality	89
Shooting a Movie	90
■ Movie Recording Precautions	91
Using Short Movie	92
Using Past Movie	95
Shooting a Snapshot while Shooting a Movie (Snapshot-In-Movie)	97

USING BEST SHOT 98

Reducing the Effects of Hand and Subject Movement	104
Taking Bright Images without Flash	105
Shooting Images of Business Cards and Documents (Business Shot)	106
Restoring an Old Photograph	109

ADVANCED SETTINGS 112

Changing the Focus Mode	112
■ Using Auto Focus	113
■ Using Macro Focus	114
■ Using Fixed Focus (Pan Focus)	118
■ Using Infinity Focus	119
■ Using Manual Focus	119
Correcting Image Brightness (EV Shift)	121
Controlling White Balance	123
Specifying ISO Sensitivity	126
Specifying the Metering Mode	127
Using the Camera's Filter Effects	129
Controlling Image Sharpness	129
Controlling Color Saturation	130
Adjusting Image Contrast	130
Date Stamping Snapshots	131
Using the On-screen Histogram to Check Exposure	132

Other Useful Recording Functions135

■ Using Key Customize to Assign Functions [◀] and [▶]	135
■ Displaying an On-screen Grid	136
■ Displaying the Image You Just Recorded (Image Review)	137
■ Using Icon Help	137
■ Using Mode Memory to Configure Power On Default Settings	138
■ Resetting the Camera to Its Initial Factory Defaults	140

VIEWING SNAPSHOTS AND MOVIES 142

Viewing a Snapshot	142
■ Listening to the Audio of an Audio Snapshot	143
Viewing a Movie	144
■ Playing Back a Movie with Anti Shake	146
Playing a Slideshow on the Camera	147
Viewing Camera Images on a TV	151
Zooming the Displayed Image	154
Using the 12-image Screen	155
Using the Calendar Screen	155
Using Image Roulette	156

EDITING IMAGES 158

Resizing a Snapshot	158
Cropping a Snapshot	159
Keystone Correction	160
Using Color Restoration to Correct the Color of an Old Photograph	162
Editing the Date and Time of an Image	164
Rotating an Image	165
Editing a Movie on the Camera	166
Creating a Snapshot of a Movie Frame (MOTION PRINT)	171

USING AUDIO 173

Adding Audio to a Snapshot	173
Recording Audio Only (Voice Recording)	176



MANAGING YOUR FILES 179

Files and Folders	179
Protecting a File Against Deletion	180
Using the FAVORITE Folder	181
Copying Files	184

DELETING FILES 186

Deleting a Specific File	186
Deleting All Files	187
Deleting FAVORITE Folder Snapshots	187

OTHER SETTINGS 189

Configuring Camera Sound Settings	189
Turning the Startup Screen On or Off	191
Specifying the File Name Serial Number Generation Rule	192
Changing the Camera Date and Time Setting	192
Using World Time	194
■ Configuring World Time Settings	194
Changing the Display Language	196
Changing the USB Port Protocol	196
[] (REC) and [] (PLAY) Button Settings ..	197
Formatting Built-in Memory	199

PRINTING 200

Types of Printing	200
Using Professional Print Service	201
Using Your Printer to Print Images	202
Using DPOF to Specify Images to be Printed and the Number of Copies	205
■ Date Stamping	208
Supported Protocols	209

USING THE CAMERA WITH A COMPUTER 211

What you can do	211
Using the Camera with a Windows Computer ..	212
■ Viewing and Storing Images on a Computer	215
■ Transfer of Images from the Camera and Management of Images on the Computer	224
■ Retouching, Reorienting, or Printing Snapshots	227
■ Playing Movies	228
■ Transferring Images to the Camera	229
■ Viewing User Documentation (PDF) Files	233
■ User Registration	234
■ Exiting the CD-ROM Menu	234

Using the Camera with a Macintosh	235
■ Viewing and Storing Images on a Macintosh	236
■ Transfer of Images from the Camera and Management of Images on Your Macintosh	242
■ Viewing User Documentation (PDF Files)	243
■ Registering as a User	244
Reading Files Directly from a Memory Card . . .	244
Memory Card Data	245

TRANSFERRING DOCUMENTS TO YOUR CAMERA (DATA STORAGE) 249

Transferring Documents to the Camera	249
■ Transferring documents from a computer running Windows	249
■ Transferring documents from a Macintosh	251
Viewing a Transferred Document on the Camera	253
Deleting Documents from Camera Memory . . .	255
■ Deleting a Document Page	255
■ Deleting Documents	256

APPENDIX

258

General Guide	258
Monitor Screen Contents	260
Menu Reference	262
Display Menu Reference	266
Indicator Lamps	267
Troubleshooting Guide	271
■ Find the Problem and Fixing It	271
■ If you have problems installing the USB driver...	275
■ Display Messages	276
Specifications	278

Getting the Most Out of Your Camera

Snapshots

Shooting with Optimum Setups

- USING BEST SHOT98
Portrait, Scenery, Night Scene, Night Scene Portrait, Children, etc.

Adding Special Effects

- USING BEST SHOT98
Monochrome, retro, etc.

Compensating for Hand or Subject Movement

- Reducing the Effects of Hand and Subject Movement . 104

Increasing Sensitivity when Lighting is Dim

- Taking Bright Images without Flash105

Making Images of Business Cards, Documents, and Meeting Information (White Board) Easier to Read

- Shooting Images of Business Cards and Documents (Business Shot)106

Selecting the Best Focus Mode for Shooting Conditions

- Changing the Focus Mode112

Eliminating Light Source Color Cast

- Controlling White Balance123

Sharpening or Softening Subject Outlines

- Controlling Image Sharpness129

Snapshots

Enhancing or Reducing Color Saturation

- Controlling Color Saturation 130

Increasing or Decreasing Contrast

- Adjusting Image Contrast 130

Movies

Normal Movie Recording

- Shooting a Movie 90

Limiting Movie Length

- Using Short Movie 92

Capturing Action Occurring before the Shutter Button is Pressed

- Using Past Movie 95

QUICK START BASICS

First, charge the battery

■ Loading the Battery into the Camera

1. Open the battery cover.

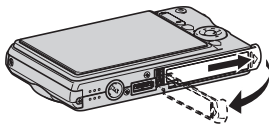

While pressing lightly on the cover, slide it in the direction indicated by the arrow to open.

2. Load the battery into the camera.

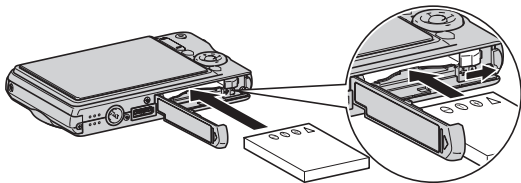

3. Close the battery cover.

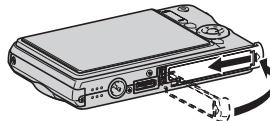

(page 37)

■ Using the USB Cradle to Charge

1. Plug the USB cradle into a household power outlet.

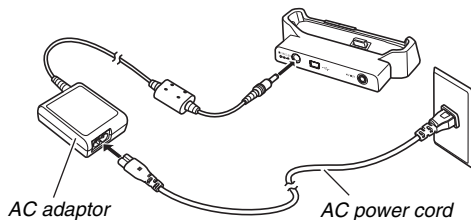

2. Place the camera onto the USB cradle.

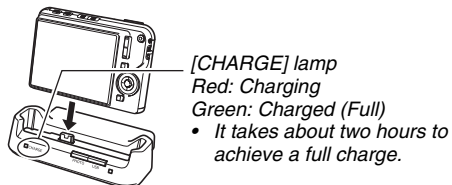

Configuring Display Language, Date, and Time Settings

(pages 192, 196)

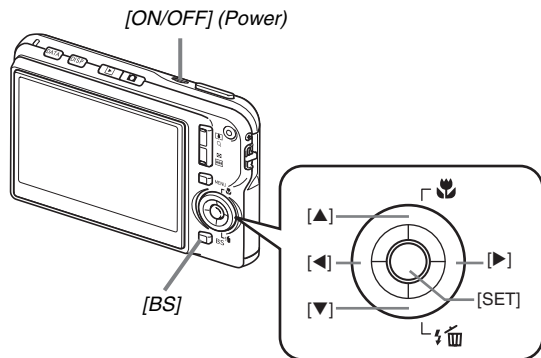

The settings on this page are required the first time you turn on the camera after purchasing it.

1. Press [ON/OFF] to turn on the camera.
2. Use [▲], [▼], [◀], and [▶] to select the language you want and then press [SET].
3. Use [▲], [▼], [◀], and [▶] to select the area where you will use the camera and then press [SET].
4. Use [▲] and [▼] to select the city where you will use the camera and then press [SET].
5. Use [▲] and [▼] to select the summer time (DST) setting you want and then press [SET].

6. Use [▲] and [▼] to select the date format and then press [SET].

Example: December 19, 2006

To display the date like this:	Select this option:
06/12/19	YY/MM/DD
19/12/06	DD/MM/YY
12/19/06	MM/DD/YY

7. Set the date and the time.

Use [◀] and [▶] to select the setting you want (year, month, day, hour, minute) and then use [▲] and [▼] to change the setting. To switch between 12-hour and 24-hour format, press [BS].

8. When all the settings are the way you want, press [SET].

9. Press [ON/OFF] to turn off the camera.

- After finishing this procedure, advance to the procedure on the next page.

Using a Memory Card

■ Loading a Memory Card into the Camera

When a memory card is loaded, the camera stores images you shoot on the card.

NOTE

- Though the camera has built-in memory, using a memory card provides additional capacity you can use to store more images, high-quality and large-size images, and longer movies.
- The camera will store images in its built-in memory if there is no memory card loaded. If you prefer to use built-in memory, skip this procedure and go to “Shooting a Snapshot” on page 16.

1. Open the battery cover.

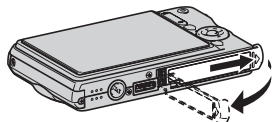

While pressing lightly on the cover, slide it in the direction indicated by the arrow to open.

2. Load a memory card into the camera.

(page 46)

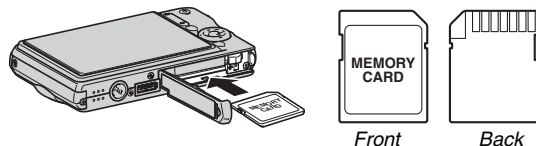

With the front of the memory card facing upwards (towards the monitor screen side of the camera), slide it into the card slot and press until it clicks securely into place.

3. Close the battery cover.

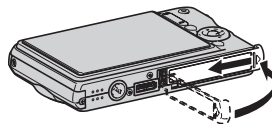

■ Formatting a Memory Card

Before you can use a memory card with your camera, you must format it.

★ **IMPORTANT!**

- Formatting a memory card that already has snapshots or other files on it, will delete its contents. Normally you do not need to format a memory card again. However, if storing to a card has slowed down or if you notice any other abnormality, re-format the card.
- Be sure to perform the following procedure on the camera to format the memory card.

1. Press [ON/OFF] to turn on the camera.
2. Press [MENU].
3. Use [◀] and [▶] to select the “Set Up” tab.
4. Use [▼] to select “Format” and then press [▶].

5. Press [▲] to select “Format” and then press [SET].

- To cancel formatting, select “Cancel” and then press [SET].

Wait until the “Busy... Please wait...” message disappears from the monitor screen before doing anything else.

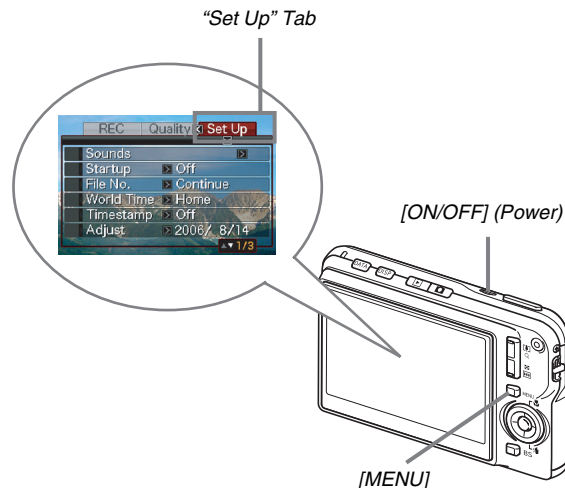

Shooting a Snapshot

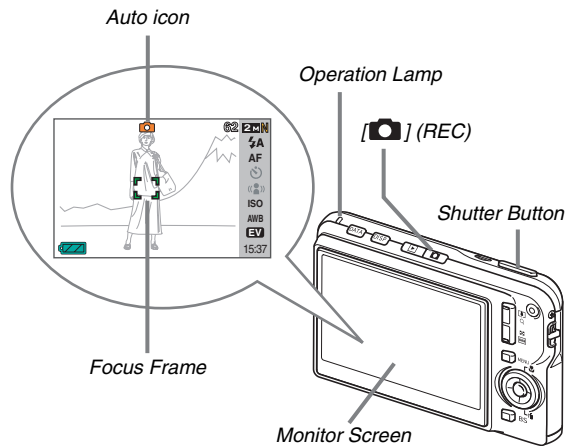

(page 63)

1. Press [] to turn on the camera.

This enters the REC mode and displays “  ” (Auto icon) on the monitor screen.

2. Point the camera at the subject.

3. While taking care to keep the camera still, half-press the shutter button.

When the image is in focus, the camera will beep, the operation lamp will light green, and the focus frame will turn green.

4. Continuing to keep the camera still, press the shutter button all the way down.

The recorded image will remain on the display for about one second, and then it will be stored in memory. After that, the camera will be ready to shoot the next image.

Snapshot Image Size and Image Quality

Your camera lets you select from among various image size and quality settings. Note that image size and quality settings affect how many images can be stored in memory.

- You can change the image size and quality settings as required to shoot a smaller or lower-resolution image for attachment to an e-mail message, for publishing on a website, etc. You can also select an image size that suits the size of paper you plan to use for printing your images.

For details, see pages 67, 69, and 278.

How do I half-press the shutter button?

The shutter button is designed to stop about half way down when you press it lightly. Stopping at this point is called a “half-press”. When you half-press the shutter button, the camera automatically adjusts exposure and focuses on the subject it is currently pointed at.

Mastering how much pressure is required for a half-press and a full-press of the shutter button is an important technique for good-looking images.

Half-press

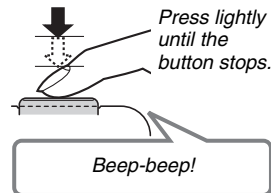

Full-press

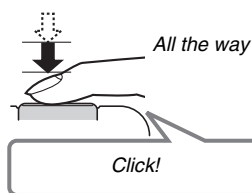

Viewing Snapshots

(page 142)

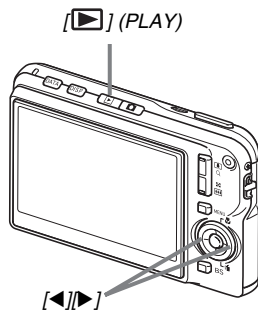

1. Press [▶] to enter the PLAY mode.

If there are multiple images in memory, use [◀] and [▶] to scroll through them.

■ To return to the REC mode

Press [📷].

Shooting a Movie

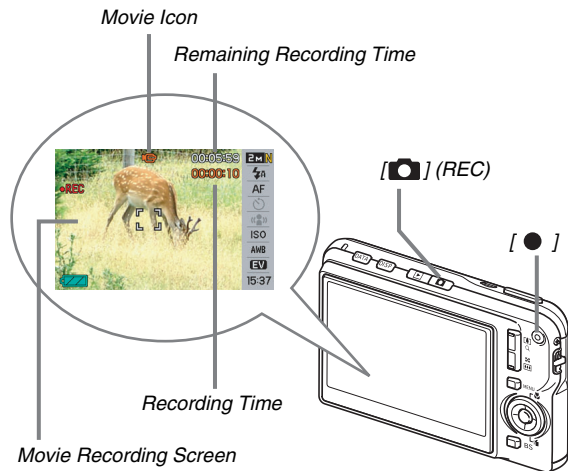

1. Press [CAMERA] to enter the REC mode.

(page 89)

2. Press [●] to start shooting the movie.

“[CAMERA]” (movie icon) remains on the monitor screen while movie recording is in progress.

- Audio is also recorded during movie recording.

3. Press [●] again to stop recording.

Movie Image Quality

Your camera lets you select from among five image quality settings (HQ, HQ Wide, Normal, Normal Wide, LP) for movies. For best camera performance, use the “HQ” (High Quality) or “HQ Wide” setting for movie recording. Movie quality is a standard that determines the detail, smoothness, and clarity of the image during playback. Reducing image quality let’s you shoot longer, so you can switch to “Normal”, “Normal Wide”, or “LP” conserve remaining memory capacity if you start to run low.

For details, see pages 89 and 279.

Viewing a Movie

The film-like frame that appears on the monitor screen indicates that this is an image from a movie.

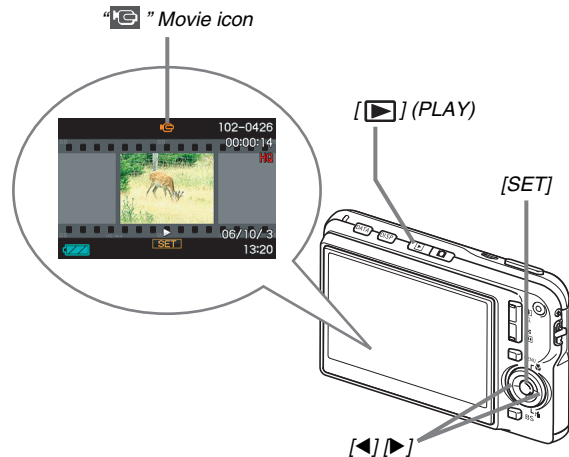

(page 144)

1. Press [▶] to enter the PLAY mode.

2. Use [◀] and [▶] to select the movie you want to play.

When scrolling through images, a movie is displayed on the monitor screen by showing its first frame.

3. Press [SET] to start playback.

The monitor screen will return to the image selection screen in step 2 after the end of the movie is reached.

- During movie playback, you can adjust volume, skip forward and back, and perform other operations (page 145).

■ To return to the REC mode

Press [📷].

Deleting a File

(page 186)

You can use the following procedure to delete files you have transferred to your computer's hard disk, images you have printed, or files you simply no longer need. This frees up memory for recording more images.

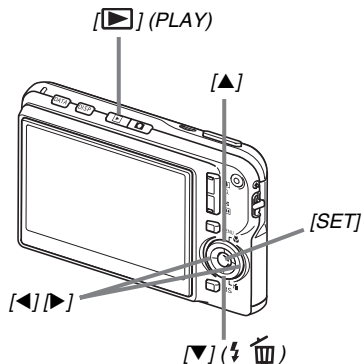

1. Press [▶].
2. Press [▼] (⚡ 🗑️).
3. Use [◀] and [▶] to select the snapshot or movie you want to delete.
4. Press [▲] to select "Delete".
 - To cancel the delete operation, select "Cancel".
5. Press [SET].

This deletes the selected snapshot or movie.

 - If you want to delete more, repeat the above procedure from step 3.
 - To quit the delete operation, press [MENU].

INTRODUCTION

Features

■ BEST SHOT for beautiful shots simply by selecting a sample image built into the camera

Simply select the scene that is similar to what you want to shoot (Night Scene Portrait, Flower, etc.), for instant camera setups. A dedicated [BS] button gives you direct access to the BEST SHOT library of sample scenes.

Example: Select for skillful shots of a fast-moving pet.

Example: Select for beautiful portraits.

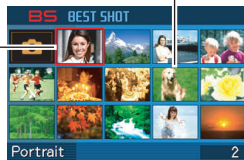

BEST SHOT Screen

■ Direct Mode Power On

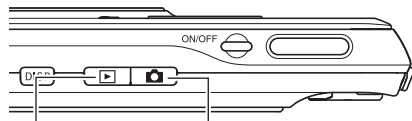

To view images, press [▶] to power up in the PLAY mode.

To record, press [📷] to power up in the REC mode.

■ A powerful collection of useful recording features

- Hand movement and subject movement reduction using high shutter speed (page 104)
- High-sensitivity recording avoids dark images, even when the flash is not being used (page 105)
- Quick Shutter for very high-speed focus (page 118)

■ High-quality (MPEG-4, DivX) movie recording

- Short Movie for shooting a short movie starting a few seconds before [●] is pressed and a few seconds after it is pressed (page 92)
- Past Movie for shooting a movie that includes scenes a few seconds before [●] is pressed (page 95)
- Normal movie recording (page 90)
- Snapshot recording, even while a movie is being recorded (page 97)
- MOTION PRINT for printing of a movie scene as a single image (page 171)
- DivX Play Bundle (page 213)
Official DivX® Certified Encoder product.
Encodes DivX® video content.



■ Powerful Print Features

- DPOF feature for easy specification of date stamping and the number of copies (page 205)
- Timestamp feature that stamps the date into the image data (page 131)
- Support for PictBridge for easy at-home printing on a printer that supports one of these standards, without a computer (page 202)

■ Multi-function USB Cradle

You can place the camera on the USB cradle to perform the following operations.

- Battery charging (page 37)
- Photo Stand slideshow of images (page 149)
- Connection to a TV for viewing on the TV screen (page 151)
- Connection to a printer for image printing (page 202)
- Connection to a computer for transfer of images to the computer (pages 217, 237)

■ Document transfer to the camera

- Bundled Photo Transport software (page 229) lets you transfer images saved on your computer or displayed on your computer screen (website data, maps, etc.) to your camera.
- Bundled CASIO DATA TRANSPORT software lets you transfer documents from your computer to the camera and take it along with you (page 249).

Read this first!

■ LCD Panel

The liquid crystal panel of the monitor screen uses high-precision technology that provides a pixel yield in excess of 99.99%.

This means that some pixels may not light or may remain lit at all times. This is due to the characteristics of the liquid crystal panel, and does not indicate malfunction.

■ Copyrights

Except for your own personal enjoyment, unauthorized use of image, movie, audio, or music files without permission of the copyright holder is strictly prohibited by copyright laws and international treaties. Also, regardless of whether such files are purchased or obtained for free, posting them on the Internet or distributing them to third parties without permission of the copyright holder is strictly prohibited by copyright laws and international treaties. Note that CASIO COMPUTER CO., LTD. shall not be held liable for any misuse of this product that infringes on the copyrights of others or that violates copyright laws.

The following terms, which are used in this manual, are registered trademarks or trademarks of their respective owners.

- SDHC Logo is a trademark.
- Windows, Internet Explorer, Windows Media, and DirectX are trademarks of Microsoft Corporation of the United States.
- Macintosh is a trademark of Apple Computer, Inc.
- MultiMediaCard™ is a trademark of Infineon Technologies AG of Germany, and licensed to the MultiMediaCard Association (MMCA).
- MMC*plus*™ is a trademark of the MultiMediaCard Association.
- Adobe and Reader are trademarks or registered trademarks in the United States and other countries of Adobe Systems Incorporated.

- DivX and associated logos are trademarks of DivX, Inc. and are used under license.
- All other company or product names mentioned herein are registered trademarks or trademarks of their respective companies.
- Photo Loader, Photohands, Photo Transport, and CASIO DATA TRANSPORT rights are owned by CASIO COMPUTER CO., LTD. Except for the rights of other companies as defined above, all rights related to these programs and other rights shall revert to CASIO COMPUTER CO., LTD.

- The contents of this manual are subject to change without notice.
 - The content of this manual has been checked at each step of the production process. Please contact us if you notice anything that is questionable, erroneous, etc.
 - Any copying of the contents of this manual, either in part or its entirety, is forbidden. Except for your own personal use, and other use of the contents of this manual without the permission of CASIO COMPUTER CO., LTD. is forbidden under copyright laws.
 - CASIO COMPUTER CO., LTD. shall not be held liable for any damages or loss suffered by you or any third party due to the use or malfunction of this product.
 - CASIO COMPUTER CO., LTD. shall not be held liable for any damages or loss suffered by you or any third party due to the use of Photo Loader, Photohands, Photo Transport, and/or CASIO DATA TRANSPORT.
 - CASIO COMPUTER CO., LTD. shall not be held liable for any damages or loss caused by deletion of memory contents due to malfunction, repair, or any other reason.
- Note that the example screens and product illustrations shown in this manual may differ somewhat by the screens and configuration of the actual camera.

Precautions during Use

■ Take test shots before shooting the final shot.

- Before shooting your final image, shoot a test shot to ensure that the camera is recording correctly.

■ Avoid Use While In Motion

- Never use the camera to record or play back images while operating an automobile or other vehicle, or while walking. Looking at the monitor while in motion creates the risk of serious accident.

■ Directly Viewing the Sun or Bright Light

- Never look at the sun or any other bright light through the camera's viewfinder. Doing so can damage your eyesight.

■ Flash

- Never use the flash unit in areas where flammable or explosive gas may be present. Such conditions create the risk of fire and explosion.
- Never fire the flash in the direction of a person operating a motor vehicle. Doing so can interfere with the driver's vision and create the risk of accident.
- Never fire the flash too close to the eyes of the subject. Doing so creates the risk of loss of eyesight.

■ Display Panel

- Do not apply strong pressure to the LCD panel surface or subject it to strong impact. Doing so can cause the display panel glass to crack.
- Should the display panel ever become cracked, never touch any of the liquid inside the panel. Doing so creates the risk of skin inflammation.
- Should display panel liquid ever get into your mouth, immediately rinse your mouth out and contact your physician.
- Should display panel liquid ever get into your eyes or onto your skin, immediately rinse with clean water for at least 15 minutes and contact your physician.

■ Connections

- Never plug any devices that are not specified for use with this camera into connectors. Connecting a non-specified device creates the risk of fire and electric shock.

■ Transport

- Never operate the camera inside of an aircraft or anywhere else where operation of such devices is restricted. Improper use creates the risk of serious accident.

■ Smoke, abnormal odor, overheating, and other abnormalities

- Continued use of the camera while it is emitting smoke or strange odor, or while it is overheating creates the risk of fire and electric shock. Immediately perform the following steps whenever any of the above symptoms are present.
 1. Turn off the camera.
 2. If you are using the AC adaptor to power the camera, unplug it from the wall outlet. If you are using battery power, remove the battery from the camera, taking care to protect yourself against burn injury.
 3. Contact your dealer or nearest CASIO authorized service center.

■ Water and Foreign Matter

- Water, other liquids, or foreign matter (especially metal) getting inside the camera creates the risk of fire and electric shock. Immediately perform the following steps whenever any of the above symptoms are present. Particular care is required when using the camera where it is raining or snowing, near the ocean or other body of water, or in a bathroom.
 1. Turn off the camera.
 2. If you are using the AC adaptor to power the camera, unplug it from the wall outlet. If you are using battery power, remove the battery from the camera.
 3. Contact your dealer or nearest CASIO authorized service center.

■ Dropping and Rough Treatment

- Continued use of the camera after it is damaged by dropping or other rough treatment creates the risk of fire and electric shock. Immediately perform the following steps whenever any of the above symptoms are present.
 1. Turn off the camera.
 2. If you are using the AC adaptor to power the camera, unplug it from the wall outlet. If you are using battery power, remove the battery from the camera.
 3. Contact your dealer or nearest CASIO authorized service center.

■ Keep Away From Fire

- Never expose the camera to fire, which can cause it to explode and creates the risk of fire and electric shock.

■ Disassembly and Modification

- Never try to take the camera apart or modify it in any way. Doing so creates the risk of electric shock, burn injury, and other personal injury. Be sure to leave all internal inspection, maintenance, and repair up to your dealer or nearest CASIO authorized service center.

■ Locations To Be Avoided

- Never leave the camera in any of the following types of locations. Doing so creates the risk of fire and electric shock.
 - Areas subject to large amounts of humidity or dust
 - Food preparation areas or other locations where oil smoke is present
 - Near heaters, on a heated carpet, in areas exposed to direct sunlight, in a closed vehicle parked in the sun, or other areas subject to very high temperatures
- Never place the camera on an unstable surface, on a high shelf, etc. Doing so can cause the camera to fall, creating the risk of personal injury.

■ Backing Up Important Data

- Always keep backup copies of important data in camera memory by transferring it to a computer or other storage device. Note that data can be deleted in the case of camera malfunction, repair, etc.

■ Memory Protection

- Whenever replacing the battery, be sure to follow the correct procedure as described in the documentation that comes with the camera. Incorrectly replacing the battery can result in corruption or loss of data in camera memory.

■ Rechargeable Battery

- Use only the specified charger unit or the specified device to charge the battery. Attempting to charge the battery by an unauthorized means creates the risk of battery overheating, fire, and explosion.
- Do not expose or immerse the battery in fresh water or salt water. Doing so can damage the battery, and cause deterioration of its performance and loss of service life.

- This battery is intended for use with a CASIO Digital Camera only. Use with any other device creates the risk of the battery damage, or deterioration of battery performance and service life.
- Failure to observe any of the following precautions creates the risk of battery overheating, fire, and explosion.
 - Never use or leave the battery near open flame.
 - Do not expose batteries to heat or fire.
 - Make sure the battery is oriented correctly when it is connected to the charger unit.
 - Never carry or store the battery together with items that can conduct electricity (necklaces, pencil lead, etc.)
 - Never disassemble the battery, pierce it with a needle, or expose it to strong impact (hit it with a hammer, step on it, etc.), and never apply solder to it. Never place the battery into a microwave oven, heater, high-pressure generating device, etc.
- Should you ever notice leakage, strange odor, heat generation, discoloration, deformation, or any other abnormal condition while using, charging, or storing a battery, immediately remove it from the camera or charger unit and keep it away from open flame.
- Do not use or leave the battery under direct sunlight, in an automobile parked in the sun, or in any other area subject to high temperatures. Doing so can damage the battery, and cause deterioration of its performance and loss of service life.
- If the battery charging does not end normally within the specified charging time, stop charging anyway and contact your local CASIO authorized service center. Continued charging creates the risk of battery overheating, fire, and explosion.
- Battery fluid can damage your eyes. Should battery fluid get into your eyes accidentally, immediately rinse them with clean tap water and then consult a physician.

- Be sure to read the user documentation that comes with the camera and special charger unit before using or charging the battery.
- If a battery is to be used by young children, make sure that a responsible adult makes them aware of the precautions and proper handling instructions, and make sure that they handle battery correctly.
- Should fluid from a battery accidentally get onto clothing or your skin, immediately rinse it off with clean tap water. Prolonged contact with battery fluid can cause skin irritation.

■ AC Adaptor

- Misuse of the AC adaptor creates the risk of fire and electric shock. Make sure you observe the following precautions when using the AC adaptor.
 - Use only the AC adaptor specified for this camera.
 - Use the AC adaptor to supply power only to devices that are specified for use with it.
 - Use a 100 to 240V AC (50/60Hz) wall outlet as a power source.
 - Never plug the power cord into a wall outlet that is shared by other devices, or into a shared extension cord.
- Misuse of the AC adaptor can cause it to become damaged, creating the risk of fire and electric shock. Make sure you observe the following precautions when using the AC adaptor.
 - Never place heavy objects on the AC adaptor or subject it to direct heat.
 - Never try to modify the AC adaptor or subject it to bending.
 - Do not twist or pull on the power cord.
 - Should the power cord or plug ever become damaged, contact your dealer or nearest CASIO authorized service center.

- Never touch the AC adaptor while your hands are wet. Doing so creates the risk of electric shock.
- Misuse of the AC adaptor creates the risk of fire and electric shock. Make sure you observe the following precautions when using the AC adaptor.
 - Never locate the power cord near a stove or other heating device.
 - When unplugging from the wall outlet, grasp the plug on the AC adaptor power cord. Never pull on the power cord.
 - Insert the plug into the wall outlet as far as it will go.
 - Unplug the AC adaptor from the wall outlet before leaving the camera unattended for long periods, such as when leaving on a trip, etc.
 - At least once a year, unplug the AC adaptor from the wall outlet and clean off any dust built up around the prongs.

■ USB Cradle and AC Adaptor Precautions

- Make sure you always remove the camera from the USB cradle before connecting or disconnecting the AC adaptor.
- Charging, USB data communication, the Photo Stand operation can cause the AC adaptor to become warm. This is normal and does not indicate malfunction.

■ Battery Life

- Battery continuous operation times provided in this manual represent the approximate amount of time before the camera turns off due to low battery power when being powered by the special battery under normal temperature (23°C (73°F)). They do not guarantee that you will be able to achieve the indicated level of operation. Actual battery life is greatly affected by ambient temperature, battery storage conditions, the amount of time spent in storage, etc.
- Leaving the camera on can run down battery and cause the low battery warning to appear. Turn off the camera whenever you are not using it.
- The low battery warning indicates that the camera is about to turn off due to low battery power. Charge the battery as soon as possible. Leaving low or dead batteries in the camera can lead to battery leakage and data corruption.

■ Data Error Precautions

- Your digital camera is manufactured using precision digital components. Any of the following creates the risk of corruption of data in camera memory.
 - While the camera is performing an operation, removing the battery or memory card from the camera, or placing the camera onto or removing it from the USB cradle
 - While the operation lamp is flashing green after turning off the camera, removing the memory card from the camera or placing the camera onto or removing it from the USB cradle
 - Disconnecting the USB cable, removing the camera from the USB cradle, or disconnecting the AC adaptor from the USB cradle while a data communication operation is being performed
 - Using a battery that is low
 - Other abnormal operations

Any of the above conditions can cause an error message to appear on the monitor screen (page 276). Perform the action indicated by the message that appears.

■ Operating Environment

- The operating temperature range of the camera is 0°C to 40°C (32°F to 104°F).
- Do not place the camera in any of the following locations.
 - In an area exposed to direct sunlight, or large amounts of moisture or dust
 - Near an air conditioner or in other areas subjected to extreme temperature or humidity
 - Inside of a motor vehicle on a hot day, or in an area subjected to strong vibration

■ Condensation

- Sudden and extreme temperature changes, such as when the camera is moved from the outdoors on a cold winter day into a warm room, can cause water droplets called “condensation” to form on the interior and the exterior of the camera. Note that condensation can cause malfunction of the camera. To avoid condensation, place the camera into a plastic bag before subjecting it to sudden temperature change. Wait until the air in the bag has had enough time to become acclimated to the new temperature before removing the camera. After that, open the battery cover and leave it open for a few hours.

■ Power Supply

- Use only the special rechargeable lithium ion battery (NP-20) to power this camera. Use of any other type of battery is not supported.
- The camera does not have a separate battery for the clock. The date and time settings of the camera are cleared about one day after power is totally cut off (from both the battery and USB cradle). If this happens, be sure to reconfigure these settings after power is restored (page 192).

■ Lens

- Never apply too much force when cleaning the surface of the lens. Doing so can scratch the lens surface and cause malfunction.
- You may sometimes notice some distortion in certain types of images, such as a slight bend in lines that should be straight. This is due to the characteristics of lens, and does not indicate malfunction of the camera.

■ Caring for your camera

- Fingerprints, dirt, and other foreign matter on the lens surface can interfere with proper operation of the camera. Avoid touching the lens surface. To clean the lens surface, use a blower to blow off dust or foreign matter and then wipe with a soft, dry cloth.
- Fingerprints, dirt, and other foreign matter on the flash can interfere with proper operation of the camera. Avoid touching the flash. If the flash becomes dirty, wipe it clean with a soft, dry cloth.
- To clean the camera, wipe it with a soft, dry cloth.

■ Monitor Screen Images

- The images that normally appear on the monitor screen during image playback are smaller than normal, and so you cannot see all of the detail of the actual image. Your camera has an image zoom feature (page 154) which you can use to enlarge the monitor screen image. You can use this feature for on-the-spot checks of important images.

■ Other Precautions

- The camera becomes slightly warm during use. This is normal and does not indicate malfunction.

GETTING READY

Charging the Battery

Your camera is powered by a rechargeable lithium ion battery (NP-20).

IMPORTANT!

- Use of any type of battery other than NP-20 is not supported.

To load the battery

1. Open the battery cover.

While pressing the battery cover, slide it in the direction indicated by the arrow.

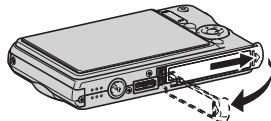

2. Load the battery into the camera.

With the EXILIM logo on the battery facing upwards (in the direction of the monitor screen), hold the stopper in the direction indicated by the arrow as you slide the battery into the camera. Press the battery in until the stopper secures it in place.

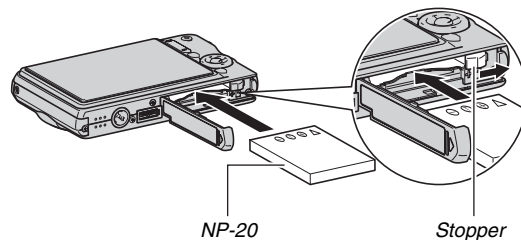

3. Close the battery cover.

Swing the battery cover closed, and then slide it securely into place as you press it against the camera.

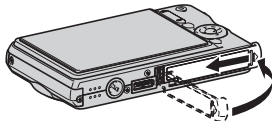

The battery is not fully charged when you use the camera for the first time after purchasing it. Use the following procedure to charge it.

To charge the battery

1. Plug the USB cradle into a household power outlet.

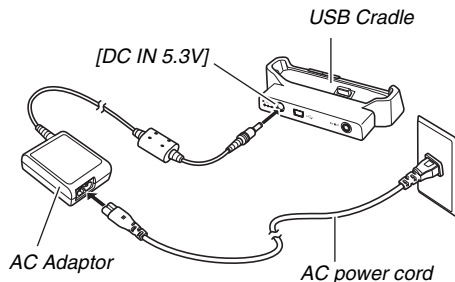

2. Make sure the camera is turned off.

If the camera is on, be sure to press [ON/OFF] to turn it off before placing it onto the USB cradle.

3. With the camera positioned so the monitor screen is facing towards you as shown in the illustration, place it onto the USB cradle.

The [CHARGE] lamp lights red and charging starts.

- It takes about two hours to achieve a full charge. Actual charging time depends on current battery capacity, remaining power, and charging conditions.

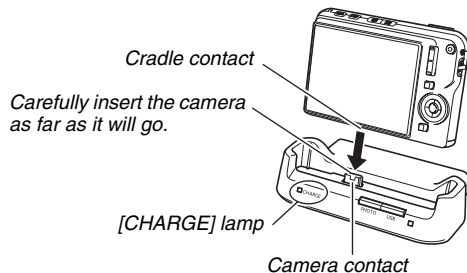

When charging is complete

The [CHARGE] lamp, which was lit red during charging, changes to green.

Remove the camera from the USB cradle and unplug the AC power cord from the power outlet.

If the [CHARGE] lamp lights amber

This indicates that charging cannot be performed because you have just finished using the camera, or because the temperature in your location is too hot or too cold. If this happens, wait until the camera returns to normal temperature. When the camera returns to a temperature where charging can be performed, the [CHARGE] lamp will light red.

If the [CHARGE] lamp flashes red

This indicates that the camera or battery is faulty, or that the battery is loaded in the camera incorrectly.

Remove the battery from the camera and check if its contacts are dirty. If they are, wipe them off with a dry cloth and then reload the battery into the camera. After confirming that the AC adaptor is plugged into the power outlet and the USB cradle, set the camera on the cradle again.

If an error still continues to occur after you perform the above steps, it could mean that the battery is faulty. Contact your nearest CASIO authorized service center.



IMPORTANT!





- Use only the bundled USB cradle or the separately available special charger unit (BC-11L) to charge the special rechargeable lithium ion battery (NP-20). The battery cannot be charged using any other type of charger device. Attempting to use a different charger can result in unexpected accident.
- Use only the AC adaptor that comes bundled with the camera. Never use any other type of AC adaptor. Use of the separately available AD-C30, AD-C40, AD-C620, or AD-C630 is not supported.

■ Battery Power Conservation Tips

- When you do not need to use the flash, select “” (flash off) for the flash setting (page 76).
- Enable the Auto Power Off and the Sleep features to protect against wasting battery power when you forget to turn off the camera (page 45).

■ Checking Remaining Battery Power

As battery power is consumed, a battery indicator on the monitor screen indicates remaining power as shown below.

Remaining Power	High ←————→ Low
Battery Indicator	 →  →  → 
Indicator Color	Light blue → Orange → Red → Red

“” indicates that battery power is low. Charge the battery as soon as possible.

Recording is not possible when “” is indicated. Charge the battery immediately.

★ IMPORTANT!

- Due to differences in the power requirements of each mode, the battery indicator may show a lower level in the PLAY mode than what it shows in a REC mode. This is normal, and does not indicate malfunction.
- Leaving the camera for about one day with no power supplied while the battery is dead will cause its date and time settings to be cleared. You will have to re-configure the settings after power is restored.

NOTE

- See page 282 for information about battery life.

Replacing the Battery

1. Open the battery cover.
2. With the camera oriented with its monitor screen facing upwards as shown in the illustration, slide the stopper in the direction indicated by the arrow and hold it there.
 - This will cause the battery to come out part way.

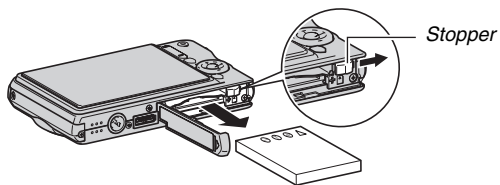

3. While still holding the stopper, pull the battery out the rest of the way.
4. Load a new battery.

Battery Precautions

■ Precautions during Use

- Operation provided by a battery under cold conditions is always less than operation under normal temperatures. This is due to the characteristics of the battery, not the camera.
- Charge the battery in an area where the temperature is within the range of 10°C to 35°C (50°F to 95°F). Charging outside this temperature range can cause charging to take longer than normal or even cause charging to fail.
- If a battery provides only very limited operation following a full charge, it probably means that the battery has reached the end of its service life. Replace the battery with a new one.

■ Storage Precautions

- Though a rechargeable lithium ion battery provides high capacity in a compact configuration, long-term storage while charged can cause it to deteriorate.
 - If you do not plan to use a battery for some time, fully use up its charge before storing it.
 - Always remove the battery from the camera when you are not using it. Leaving a battery in the camera can cause it to discharge and go dead, which will require longer charging when you need to use the camera.
 - Store batteries in a cool, dry place (20°C (68°F) or lower).

Turning Power On and Off

■ Turning Power On

To turn power on and enter the REC mode

Press [ON/OFF] (Power) or [] (REC).

To turn power on and enter the PLAY mode

Press [] (PLAY).

Pressing a button causes the operation lamp to light green momentarily and turns on power.

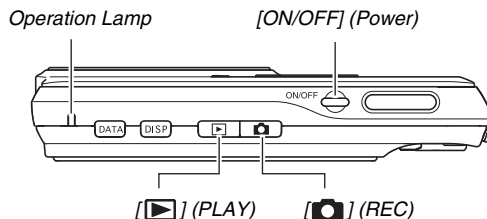

IMPORTANT!

- Pressing [ON/OFF] or [] (REC) to turn on power also causes the lens to extend. Take care there is nothing pressing against or hitting the lens. Holding the lens with your hand so it cannot extend creates the risk of malfunction.





NOTE

- Pressing [] (PLAY) while in the REC mode switches to the PLAY mode. The lens retracts about 10 seconds after switching modes.
- Auto Power Off (page 45) will turn off power automatically if you do not perform any operation for a preset amount of time. If this happens, turn power back on.

Turning Power Off

Press [ON/OFF] (Power).

NOTE

- You can configure the camera so power does not turn on when you press [] (REC) or [] (PLAY). You can also configure the camera to turn off when you press [] (REC) or [] (PLAY) (page 197).

Turning On Power for the First Time

The first time you load a battery into the camera, a screen appears for configuring screen text language, date, and time settings. Use the procedure under “Configuring Display Language, Date, and Time Settings” (page 12) to configure the settings correctly.



IMPORTANT!

- Failure to set the date and time will cause the wrong date and time data to be recorded with images.
- If you make a mistake when configuring the language, date, and time settings, you can change the settings (pages 192, 196).

■ Battery Power Conservation Features

The camera is equipped with two features for conserving battery power, as described below.

Feature Name	Description	Settings
Sleep	In the REC mode, the monitor screen turns off (goes into a sleep state) if no operation is preformed for a preset amount of time. Press any button to turn the monitor screen back on. Note that the Sleep feature does not operate in the PLAY mode.	30 sec 1 min 2 min Off
Auto Power Off	Power it turned off if no operation is performed for a preset amount of time.	2 min 5 min

1. Press [MENU].
2. Use [◀] and [▶] to select the “Set Up” tab.
3. Use [▲] and [▼] to select the item you want to configure (“Sleep” or “Auto Power Off”) and then press [▶].

4. Use [▲] and [▼] to select the sleep or Auto Power Off trigger time and then press [SET].

Selecting “Off” for the sleep setting disables the sleep feature.

NOTE

- Auto Power Off and sleep are disabled under the following conditions.
 - When there is a connection between the camera and computer or other device via the USB cradle
 - During a slide show
 - During Voice Recording file playback
 - During movie recording and playback

Using a Memory Card

You can store images you shoot with the camera on a memory card. It is up to you to purchase a commercially available memory card. In addition to memory card storage, the camera also has built-in memory, which is enough to hold a few snapshots or a short movie. Use built-in memory for test purposes, emergency use, etc.

NOTE

- Images can be copied between the camera’s built-in memory and a memory card (page 184).
- The following data is stored in built-in memory. It cannot be copied to a memory card.
 - BEST SHOT mode user image information
 - FAVORITE folder
 - Mode memory settings
 - Start-up screen image

Supported Memory Cards

Your camera supports use of SD, SDHC, MMC (MultiMediaCard), or MMC*plus* (MultiMediaCardplus) memory cards.





Memory Used for Storage

Images recorded while a memory card is loaded are saved to the memory card. When no memory card is loaded, images are saved in built-in memory.

- Note that you cannot save images in built-in memory while a memory card is loaded in the camera.



IMPORTANT!

- See the instructions that come with the memory card for information about how to use it.
- Certain types of cards can slow down processing speeds. If you are using a slow memory card, you may not be able to record a movie using the “HQ” or “HQ Wide” image quality setting. Because of this, use of a memory card with a maximum transfer speed of at least 10MB per second is recommended.
- Certain types of memory cards take longer to record data, which can cause movie frames to be dropped. “ ” and “ REC ” flash on the monitor screen during recording to let you know when a frame has been dropped. Use of a memory card with a maximum transfer speed of at least 10MB per second is recommended.
- SD memory cards and SDHC memory cards have a write protect switch. Use it when you need to guard against accidentally deleting data. Note, however, if you write protect a memory card you must then turn write protection off whenever you want to record to the card, format it, or delete any of its images.

- Electrostatic charge, electrical noise, and other phenomena can cause data to become corrupted or even lost. Make sure that you always back up important data on other media (CD-R, CD-RW, MO disk, hard disk, etc.).

Loading a Memory Card into the Camera

IMPORTANT!

- Make sure you always turn off the camera before loading or removing a memory card.
- Be sure to orient the card correctly when loading it. Never try to force a memory card into the slot when you feel resistance.

1. Open the battery cover.

While pressing the battery cover, slide it in the direction indicated by the arrow.

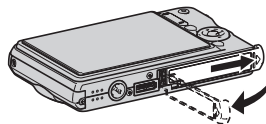

2. Load a memory card into the camera.

Positioning the memory card so its front is facing upwards (towards the monitor screen side of the camera), slide it into the card slot all the way in until you hear it click securely into place.

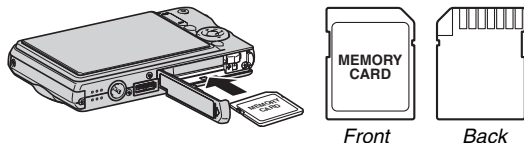

3. Close the battery cover.

Swing the battery cover closed, and then slide it securely into place as you press it against the camera.

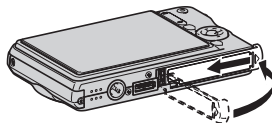

Replacing the Memory Card

1. Remove the memory card from the camera.

Press the memory card and then release it, so it comes part way out. Pull the card out the rest of the way by hand.

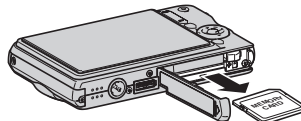

2. Load the other memory card.

IMPORTANT!

- Never insert anything besides an SD memory card, SDHC memory card, MMC (MultiMediaCard), or MMC*plus* (MultiMediaCardplus) into the memory card slot. Doing so can lead to malfunction.
- Should water or any foreign object ever get into the card slot, immediately turn off the camera, remove the battery, and contact your retailer or nearest CASIO authorized service center.
- Never remove a card from the camera while the operation lamp is flashing green. Doing so can cause the image save operation to fail and even damage the memory card.

Formatting a Memory Card

Before using a new memory card for the first time, you need to format it. Once you format a memory card, you will not need to format it each time you use it.

Formatting a memory card that already has files on it will delete its contents.

IMPORTANT!

- Note that data deleted by a memory card format operation cannot be recovered. Double-check to make sure that you really want to delete all the contents of the memory card before proceeding with the format operation.
- Even if the file data on a memory card is protected (page 180), formatting the card will delete all its data.
- Be sure to use the camera to format a memory card. Formatting a memory card on a computer and then using it in the camera can slow down data processing by the camera. In the case of an SD memory card or SDHC memory card, formatting on a computer can result in non-conformity with the SD format, causing problems with compatibility, operation, etc.

- 1. Load the memory card you want to format into the camera.**
- 2. Turn on the camera and press [MENU].**
- 3. On the “Set Up” tab, select “Format” and then press [▶].**
- 4. Use [▲] and [▼] to select “Format” and then press [SET] to start formatting.**

After formatting is complete, enter the PLAY mode and check to make sure the “There are no files.” message appears on the monitor screen.

- To exit the format operation without formatting, select “Cancel”.

■ Memory Card Precautions

- If a memory card starts to behave abnormally, you can restore normal operation by reformatting it. However, it is recommended that you always take along more than one memory card whenever using the camera far away from the home or office.
- If you experience problems while trying to playback recorded images, try re-formatting the memory card.
- As you record data to and delete data from a memory card a number of times, it loses its ability to retain data. Because of this, periodic re-formatting of a memory card is recommended.
- Make sure that the battery is charged fully before starting a formatting operation. Formatting may not be performed correctly and the memory card may be damaged if the camera powers down while formatting is in progress.
- Never open the battery cover while formatting is in progress. Doing so can damage the memory card.

Using On-screen Menus

The following are menu operations you will need to use to configure camera settings. Take a few moments to become familiar with them.

- See “Menu Reference” on page 262 for information about menu contents.

Example Menu Screen

- Menu contents are different in the REC mode and PLAY mode. This screen shows a REC mode menu.



Menu Screen Operation Buttons

[◀] [▶]	Select tabs. [▶] is also used to apply a setting.
[▲] [▼]	Select a setting option.
[SET]	Applies the selected settings.
[MENU]	Exits the menu screen.

The following is the procedure for menu operations in the REC mode.

- 1. In the REC mode, press [MENU].**
This displays the menu screen.
- 2. Use [◀] and [▶] to select the tab where the item you want to configure is located.**
Here, we will select the “REC” tab.

3. Use [▲] and [▼] to select the item you want to configure and then press [▶].

Example: Select “Continuous” and then press [▶].



4. Use [▲] and [▼] to select the setting you want.

5. Apply the setting.

- Pressing [SET] applies the selected setting and exits the menu screen.
- Pressing [◀] instead of [SET] applies the selected setting and returns to the menu screen. You can then continue configuring other settings, if you want.
- To select another tab, press [◀], use [▲] to return to the tab and then use [◀] and [▶] to switch to another tab.

Configuring Monitor Screen Settings

You can use the display menu to configure various monitor screen settings.

- See “Display Menu Reference” on page 266 for information about display menu contents.

Example Display Menu Screen

- Menu contents are different in the REC mode and PLAY mode. This screen shows the REC mode menu.

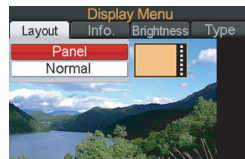

Menu Screen Operation Buttons

[◀] [▶]	Selects a setting option. [▶] is also used to apply a setting.
[▲] [▼]	Selects a setting option.
[SET]	Applies the selected settings.
[DISP]	Exits the menu screen.

The following is the procedure for menu operations in the REC mode.

- 1. In the REC mode, press [DISP].**
This will display the display menu screen.
- 2. Use [◀] and [▶] to select the setting you want.**
- 3. Use [▲] and [▼] to select the setting you want.**
 - If you want to configure other settings, repeat steps 2 and 3.
- 4. After all the settings are the way you want, press [SET].**
 - This will apply the settings and exit the menu screen.

Selecting a Screen Layout (Layout)

The contents of the layout setting menu depend on whether the camera is in the REC mode or the PLAY mode.

■ REC Mode Screen Layout

For the REC mode, the screen layout settings let you select the layout of icons.

Layout Type	Description
Panel (Operation Panel)	<p>Pressing [SET] in the REC mode while “Panel” (Operation Panel) is selected as the layout type will cause the top icon of the Operation Panel to become highlighted (selected). You can then use the Operation panel to change settings. Since there are few icons superimposed on the displayed image, they do not interfere with recording.</p>



Layout Type	Description
Normal	<p>With this option, the image being composed completely fills the monitor screen. This setting is best when you want to display the subject on a large 16:9 aspect ratio monitor screen (page 68). Icons are superimposed on the displayed image.</p> 

The following procedure shows how to use Panel (Operation Panel).

1. In the REC mode, press [SET].

This highlights (selects) the top icon of the Operation Panel.



2. Use [▲] and [▼] to select the icon of the setting you want to change.

3. Use [◀] and [▶] to change the setting.

- If you want to configure other settings, repeat steps 2 and 3.

4. After all the settings are the way you want, press [SET].

- This will apply the settings and return to normal operation (no Operation Panel icon selected).

IMPORTANT!

- Image quality cannot be changed using Panel (Operation Panel).
- Panel (Operation Panel) is not displayed while Short Movie, Past Movie, Voice Recording, or Zoom Continuous Shutter is being used.
- The date display format is always month/day and the time display format is always 24 hours, regardless of the current settings of the camera's "Date Style" and "Adjust" (pages 193, 194).

■ PLAY Mode Screen Layout

The PLAY mode screen layout settings let you select how display images are shown on the monitor screen.

Layout Type	Description
Normal	<p>With this setting, 100% of the display image is always visible. With some aspect ratios, black bands may appear above and below, or to the left and right of the image.</p> 

Layout Type	Description
Wide	<p>With this setting, the display image is the maximum possible size that allows the entire image to be displayed horizontally. With some aspect ratios, the top and bottom of the image will be cut off.</p> 

Turning Display Information On and Off (Info.)

With “Info.” you can turn display information on and off. You can configure separate settings for the REC mode and PLAY mode.

Display Information Setting	Description
Show	Turns on display of camera setting and other information.
+Histogram	Turns on display of camera setting and other indicators, along with a histogram (page 132).
Hide	Turns off display of all information.

REC Mode (Layout: Panel (Operation Panel))

Show



+Histogram

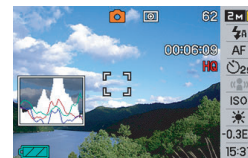

Hide



REC Mode (Layout: Normal)

Show



+Histogram



Hide



PLAY mode

Show



+Histogram



Hide



Adjusting Monitor Screen Brightness (Brightness)

You can use the “Brightness” setting to adjust the brightness of the monitor screen. This setting is the same in the REC mode and PLAY mode.

Brightness Setting	Description
Auto	With this setting, the camera detects available light levels and automatically adjusts the brightness of the monitor screen accordingly. This is the setting you should normally use. In the PLAY Mode, the brightness of the monitor screen remains constant even if the available light level changes.
+2	Brightness that is greater than +1, which makes the screen easier to view. This setting consumes more power.
+1	Bright setting for outdoor use, etc. This setting results in brightness that is greater than the 0 setting.

Brightness Setting	Description
0	Normal monitor screen brightness for indoor use, etc.
-1	Low monitor screen brightness for nighttime use, indoor use under dark conditions, etc.

Adjusting Monitor Screen Image Quality (Type)

You can use the “Type” setting to adjust the quality of the monitor screen image. This setting is the same in the REC mode and PLAY mode.

Quality Setting	Description
Dynamic	Increases contrast of the monitor screen image so the subject stands out for easier viewing and framing when shooting under bright conditions.
Vivid	Makes the monitor screen image a bit brighter than the actual image for more clarity. Makes recorded image brighter when showing it to others.
Real	Displays the monitor screen image so it is as near as possible to the one recorded by the camera.

Quality Setting	Description
Night	This setting provides a clearer screen image when shooting under dark conditions, and comes in handy when recording at night with a tripod.
Power Saving	Consumes slightly less power than the other settings, and extends battery life. Note that power saving is disabled when “Auto” is selected for the monitor screen brightness setting.

If you lose your way...

Perform one of the following operations if you find that you have gotten lost while performing button operations during recording or playback.

REC mode

Current Screen	To return to the normal snapshot or movie recording screen, press:
Menu screen	[MENU] or [📷]
Display Menu screen	[DISP] or [📷]
BEST SHOT screen	[BS] or [📷]
"There are no files." screen	Press [📷].
PLAY mode screen	Press [📷].

PLAY mode

Current Screen	To return to the normal playback screen
Menu screen	[MENU] or [▶]
Display Menu screen	[DISP] or [▶]
REC mode screen	Press [▶]
Delete screen	Press [▶]. You could also select "Cancel" and then press [SET].

Using the Camera on a Trip

Extra Batteries

Taking along extra fully charged batteries (NP-20) is recommended while on a trip in order to avoid not being able to shoot images due to the battery going dead.

Using the Camera in another Country

Note the following precautions.

- The bundled AC adaptor is designed for operation with any power supply in the range of 100 V to 240 V AC, 50/60 Hz. This means the AC adaptor can be used in various countries around the world. Note, however, that there may be some problems with the AC power cord withstand voltage and with the configuration of power outlet shapes in certain geographic areas. Before trying to use the AC adaptor in another country, be sure to check with your travel agent concerning the local power supply.
- Do not use a voltage adaptor with this camera.

SHOOTING A SNAPSHOT

Holding the Camera Correctly

Holding the camera with one hand can result in accidental hand movement. Hold the camera securely with both hands when shooting snapshots.

- To protect against accidentally dropping the camera, attach the wrist strap and make sure it is around your fingers or wrist while you are operating the camera.
- The supplied strap is intended for use with this camera only. Never use it for any other purpose.
- Never swing the camera around by its strap.

Horizontal

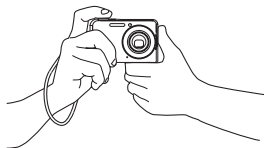

Hold the camera as shown in the illustration, with your arms firmly against your sides.

Vertical



Hold the camera so the flash is above the lens.

IMPORTANT!

- Take care that your fingers and the strap do not cover any of the areas indicated in the illustration.

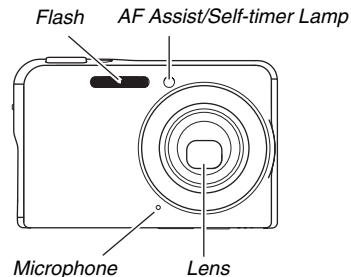

NOTE

- Good-looking images are impossible if you move the camera when you press the shutter button or while the Auto Focus operation is being performed. Holding the camera correctly, carefully press the shutter button and take care that you do not move the camera as the shutter releases. This is especially important when available lighting is low, which slows down the shutter speed.

Shooting a Snapshot

1. Press [📷] (REC) to enter the REC mode.

Confirm that the subject (people, scenery, etc.) and the Auto icon “📷” are displayed on the monitor screen.

If any icon other than the Auto icon “📷” is displayed, switch to “Auto” (page 98).

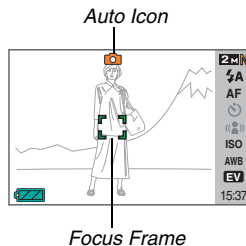

2. Focus the image.

While the focus frame is aligned with the subject, half-press the shutter button.

Auto Focus will focus the image automatically, and the focus frame and operation lamp will turn green. The shutter speed, aperture, and ISO sensitivity also will be set automatically.

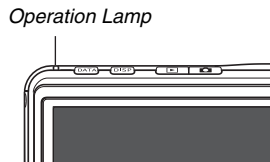
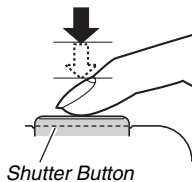

3. Shoot the image.

When the image is focused, press the shutter button the rest of the way.

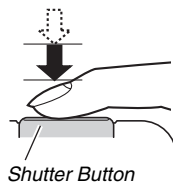

This will shoot the snapshot and save it to the memory card or the camera's built-in memory.

NOTE

- The aperture value indicates the size of the opening that lets light into the camera. A larger aperture value indicates a smaller opening. The camera adjusts this setting automatically.
- Shutter speed indicates the amount of time that light is allowed into the camera. A slower shutter speed means that light is allowed in for a longer time. Shutter speed is indicated on the monitor screen as seconds (1/1000 second, etc.) The camera adjusts this setting automatically.

If the image does not focus...

If the focus frame stays red and the operation lamp is flashing, it means that the image is not in focus (because the subject is too close, etc.). Point the camera at the subject and try to focus again.



Checking a Snapshot

A snapshot will remain on the monitor screen for a short while after you shoot it and then disappear when the camera gets ready for the next image.

Perform the following operation to view a snapshot after you shoot it.

Press [].

This will display the snapshot you just shot.

Use [] and [] to scroll through other images in memory.

To return to the REC mode, press [].

■ Using Quick Shutter

Pressing the shutter button all the way down without waiting at the halfway point shoots the image using Quick Shutter (page 118). Quick Shutter lets you record right away, so you don't miss those special moments waiting for Auto Focus.

- Quick Shutter focuses much quicker than normal Auto Focus. It comes in handy when shooting a fast-moving subject. It also eliminates worries of spoiled shots when you ask someone else to record and image for you, and they press the shutter button all the way without waiting for Auto Focus.
- Quick Shutter is turned on as the initial factory default setting. In cases when you want to take a little time for accurate focus, turn off Quick Shutter.

Specifying Image Size

A digital camera image is a collection of small dots (pixels). The size of an image indicates how many pixels it contains, and is expressed as horizontal pixels × vertical pixels. The initial factory default image size setting is 7M (3072 × 2304 pixels). Note that a larger image takes up more memory.

- For information about image size, image quality, and number of images that can be stored, see page 279.
This setting applies to snapshots only.
- For information about movie image size, see page 89.

1. In the REC mode, press [MENU].
2. On the “Quality” tab, select “Size” and then press [▶].
3. Use [▲] and [▼] to select an image size and then press [SET].

NOTE

- You can also use the Panel (Operation Panel) (page 54) to change the image size setting.
- The following information changes on the display during the image size selection operation.
 - Image size in megabytes (M) (5M, etc.)
 - Image size in pixels (2560 × 1920, etc.)
 - Optimum print paper size

Image Size (Pixels)		Print Paper Size	
Larger	7M	3072 × 2304	A3 Print
	3:2	3072 × 2048	A3 Print
↕	16:9	3072 × 1728	HDTV
	5M	2560 × 1920	A3 Print
	3M	2048 × 1536	A4 Print
	2M	1600 × 1200	3.5" × 5" Print
	Smaller	VGA	640 × 480

- Selecting 3:2 (3072 × 2048 pixels) records images with an aspect ratio of 3:2, which matches the standard aspect ratio (3:2) of print paper.
- VGA (640 × 480 pixels) is the optimum size when attaching images to e-mail.
- Print paper sizes should be thought of as rough estimates only (200 dpi print resolution).
- The letters “HDTV” stand for “High Definition Television”. An HDTV screen has an aspect ratio of 16:9, which makes them wider than the usual 4:3 aspect ratio of television screens of the past. Your camera can record images that are compatible with the aspect ratio of an HDTV screen.

Specifying Image Quality

Your camera lets you select “Fine” (maximum image quality), “Normal”, or “Economy” (maximum memory economy) for the image quality setting. The initial setting is “Normal”. Select “Fine” if you want to give priority to image quality, or “Economy” to give priority to the number of images you can store in memory.

- For information about image size, image quality, and number of images that can be stored, see page 278.

This setting applies to snapshots only.

- For information about movie image quality, see page 89.

- 1. In the REC mode, press [MENU].**
- 2. On the “Quality” tab, select “ Quality” and then press [▶].**
- 3. Use [▲] and [▼] to select the image quality setting you want and then press [SET].**

NOTE

- The “Fine” setting helps to bring out details when shooting a finely detailed image of nature that includes dense tree branches or leaves, or an image of a complex pattern.

Turning Off the AF Assist Lamp

The AF assist lamp emits light that helps the camera focus when you half-press the shutter button under dark lighting conditions.

The AF assist lamp does not light when lighting is bright.

The initial factory default setting is AF assist lamp on.

Turning off the AF assist lamp using the following procedure is recommended when shooting the image of a nearby person.

AF Assist/Self-timer Lamp

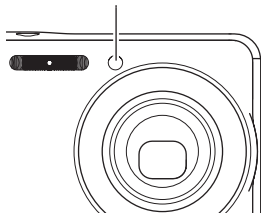

1. In the REC mode, press [MENU].
2. On the “REC” tab, select “AF Assist Light” and then press [▶].
3. Use [▲] and [▼] to select “Off” and then press [SET].

When you want to turn on the AF assist lamp, select “On” here.

IMPORTANT!

- Do not look directly into the AF assist/self-timer lamp or point it directly at a person’s eyes.

Snapshot Shooting Precautions

■ Operation

- While the operation lamp is flashing green, never open the battery cover or place the camera onto or remove it from the USB cradle. Doing so can result in incorrect storage of the image you just shot, damage to other images stored in memory, malfunction of the camera, etc.
- Shooting a dark subject while “Auto” is selected for the ISO sensitivity (page 126) setting will cause the camera to increase sensitivity and increase shutter speed automatically. Such conditions can cause digital noise in the image.
- If unneeded light is shining directly onto the lens, shade the lens with your hand when shooting an image.

■ Monitor Screen when Shooting Snapshots

- The image that appears on the monitor screen is for image composition. The actual image will be recorded at the quality set for the image quality setting.
- Subject brightness conditions can cause monitor screen response to slow and can cause digital noise in the monitor screen image.
- Shooting a very bright subject can cause a vertical band to appear in the monitor screen image. This does not indicate malfunction. The band will not be recorded in a snapshot, but will be recorded in the case of a movie.

■ Shooting Indoors under Fluorescent Lighting

- Minute flickering of fluorescent lighting can affect the brightness or color of an image.

Auto Focus Restrictions

- Proper focus may not be possible when shooting the following types of subjects.
 - Solid color wall or other very low contrast subject
 - Strongly back lit subject
 - Very shiny subject
 - Blinds or other subject with a repeating horizontal pattern
 - Multiple subjects at varying distances from the camera
 - Subject in a dark location
 - Subject that is too far away for light from the AF assist lamp to reach
 - Fast-moving subject
 - Subjects outside the focus range of the camera
- Proper focus may not be possible if the camera is moved while shooting.
- An image may be out of focus even though the operation lamp is lit green and the focus frame is green.
If you cannot focus properly, try using focus lock (page 117) or manual focus (page 119).

Shooting with Zoom

Your camera provides you with 3X optical zoom (which changes the lens focal distance), which can be used in combination with digital zoom (which digitally process the center portion of the image to enlarge it) for total zoom capabilities of 12 - 42.6X.

IMPORTANT!



- Generally speaking, the higher the digital zoom factor, the coarser the image that is recorded. However, digital zoom can be used up to a certain point without causing deterioration of the image.

1. Enter the REC mode.

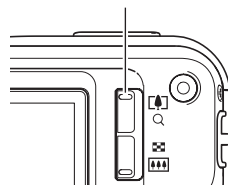
 Zoom button



2. Press the zoom button to change the zoom factor.

To do this:	Press this side of the zoom button:
Enlarge the subject and narrow the range	[] (telephoto)
Reduce the size of the subject and broaden the range	[] (wide angle)

- For more information, see “Optical Zoom and Digital Zoom Switch Point” on page 74.

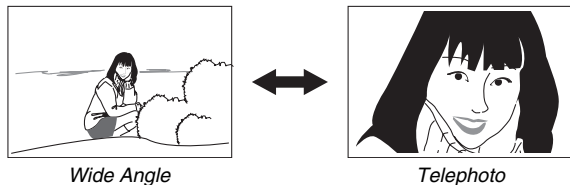

3. Press the shutter button to shoot.

NOTE

- Performing a zoom operation changes the lens aperture.
- Use of a tripod is recommended to protect against hand movement when using the telephoto setting (zoom in).
- Optical zoom is disabled while shooting a movie. Digital zoom only is available while shooting a movie. Make sure you select the optical zoom setting you want to use before you press the shutter button to start shooting your movie.

■ Optical Zoom and Digital Zoom Switch Point

If you hold down the [] side of the zoom button in step 2 of the above procedure, the zoom operation will stop when the optical zoom factor reaches its maximum. Momentarily releasing the zoom button and then holding down its [] side will switch to digital zoom, which you can use to set an even higher zoom factor.

- When the zoom pointer moves past the maximum limit of optical zoom. Also, the zoom bar indicates the approximate zoom factor.

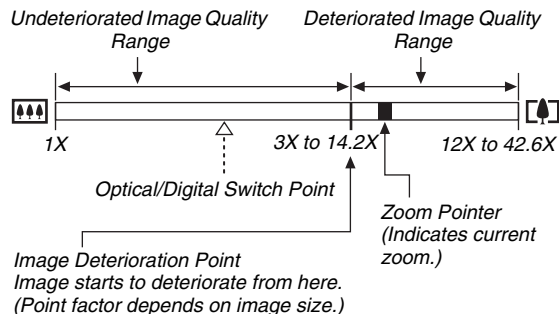
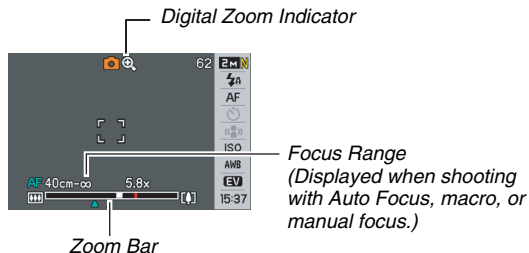

- The image deterioration point depends on the image size (page 68). The smaller the image size, the higher the zoom factor you can use before reaching the image deterioration point. Though digital zoom generally causes a deterioration of image quality, some digital zoom without image deterioration is possible with image sizes of “5M (2560 × 1920 pixels)” and smaller. The range in which you can use digital zoom without image deterioration is indicated on the display. The deterioration point depends on the image size.
- The digital zoom range of the zoom indicator is shown on the monitor screen only while “Digital Zoom” is turned on.

IMPORTANT!

- Digital zoom is not supported while “Timestamp” (page 131) is turned on.





■ **Turning Off Digital Zoom**

You can turn off digital zoom if you want to use optical zoom only. This will help to avoid deteriorated images due to accidentally switching over from optical zoom to digital zoom when shooting snapshots.

- 1. In the REC mode, press [MENU].**
- 2. On the “REC” tab, select “Digital Zoom” and then press [▶].**
- 3. Use [▲] and [▼] to select “Off” and then press [SET].**
 - If you want to show the entire digital zoom range, select “On” here.

Using Flash

Perform the following steps to select the flash mode you want to use.

Flash Setting	Description
 Auto Flash	Flash fires automatically in accordance with exposure (amount of light and brightness) conditions. <ul style="list-style-type: none">• Initial factory default setting.
 Flash Off	Flash does not fire.
 Flash On	Flash always fires. <ul style="list-style-type: none">• This setting can be used to brighten a subject that normally comes out dark due to daylight or backlight (daylight synchro flash).
 Soft Flash	Always use soft flash, regardless of exposure conditions. <ul style="list-style-type: none">• Use this setting when you want to suppress the flash to avoid reflection, etc.
 Red Eye	Flash fires automatically in accordance same conditions as Auto Flash. This setting can be used to reduce the red eye effect that occurs in images of people shot with flash.

Approximate Flash Range (ISO Sensitivity: Auto)

Wide Angle : 0.15 m to 3.9 m (0.5' to 12.8')

Telephoto : 0.4 m to 2.0 m (1.3' to 6.6')

- The flash range changes in accordance with optical zoom.

1. In the REC mode, press [▼] (⚡ 📷) once.

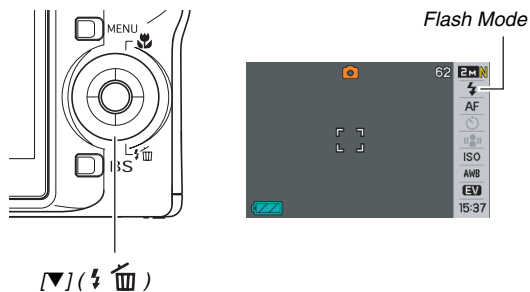

2. Use [◀] and [▶] to select the flash setting you want and then press [SET].

3. Press the shutter button to shoot.

NOTE

- If you are using the “Normal” Screen Layout setting (page 54), each press of [▼] (⚡ 📷) will cycle through the available flash settings.

IMPORTANT!

- When using flash, take care that the flash window is not blocked by your fingers or the camera strap.
- When the ISO sensitivity setting is “Auto” (page 126), sensitivity is high and there is increased digital noise when flash is used. Decreasing ISO sensitivity shortens the range of the flash, but is also reduces digital noise.

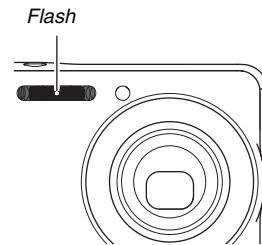

Red-eye reduction

Using the flash to shoot at night or in a dimly lit room can cause red spots inside the eyes of people who are in the image. This is caused when the light from the flash reflects off of the retina of the eye. When red-eye reduction is selected as the flash mode, the camera fires a pre-flash to cause the irises in the eyes of any people in the image to close, which reduces the chance of red eye.

IMPORTANT!

- Note the following important points when using red-eye reduction.
 - Red-eye reduction does not work unless the people in the image are looking directly at the camera (flash). Before pressing the shutter button, call out to the subjects so they all look at the camera.
 - Red-eye reduction may not work very well if the subjects are located far away from the camera.

■ Checking the Flash Mode

The current flash mode is indicated on the monitor screen and by the operation lamp when you half-press the shutter button.

Operation Lamp*

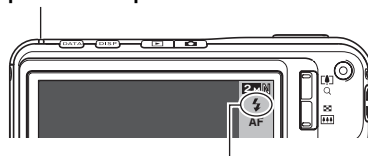

 " " indicates flash will fire.

* Operation lamp

When the operation lamp is this:	It means this:
Flashing Orange	Flash is charging.
Lit or Flashing Green*1	Flash charging is complete.

*1 Flashes green when focusing is not possible with Auto Focus or Macro Focus.

■ Changing the Flash Intensity

1. In the REC mode, press [MENU].
2. On the “Quality” tab, select “Flash Intensity” and then press [▶].
3. Use [▲] and [▼] to select the flash intensity setting you want and then press [SET].

You can set one of five levels, from -2 (weakest) to +2 (strongest).

★ IMPORTANT!

- Flash intensity may not change when the subject is too far away or too close.

■ Using Flash Assist

The subject in an image will look too dark if flash intensity is not enough to reach a subject that is too far away. When this happens, you can use flash assist to supplement the brightness of the subject so it appears as if flash illumination was sufficient.



Flash assist not used



Flash assist used

Flash assist is turned on as the initial factory default setting. Use the following procedure to turn off flash assist when you do not want to use it.

1. In the REC mode, press [MENU].
2. On the “Quality” tab, select “Flash Assist” and then press [▶].
3. Use [▲] and [▼] to select “Off” and then press [SET].

When you want to use flash assist, select “Auto” here.

IMPORTANT!



- Flash assist may not produce the desired result for some types of subjects.
- Any of the following can result in the flash assist effect being canceled out.
 - Changing the flash intensity (page 79)
 - Correcting brightness (EV shift) (page 121)
 - Changing ISO sensitivity (page 126)
 - Changing the contrast setting (page 130)
- Using flash assist can cause an increase in digital noise.

■ **Flash Precautions**

- The desired effect may not be obtained when the subject is too far away or too close.
- Flash charging time depends on operating conditions (battery condition, ambient temperature, etc.) With a fully charged battery, it takes anywhere from a few seconds to 7 seconds.
- Shooting with flash turned off when lighting is dim results in a slow shutter speed, which can cause image blur due to hand movement. Secure the camera with a tripod, etc. Noise is generated in images shot under these conditions, which can make the image appear rough.
- With red eye reduction, the flash is fired automatically in accordance with exposure. It does not fire in areas where lighting is bright.
- The presence of outdoor sunlight, fluorescent lighting, or some other light source can cause abnormal image colors.

Using the Self-Timer

With the self-timer, pressing the shutter button starts a timer, and the shutter is released and the image is shot after a fixed amount of time.

Self-Timer Type	Description
 10 sec	10-second self-timer
 2 sec	2-second self-timer <ul style="list-style-type: none">When shooting under conditions that slow down the shutter speed, you can use this setting to prevent blur due to hand movement.
 X3 (Triple Self-timer)	This option shoots three images: one image 10 seconds after the shutter button is pressed, the next image one second after the camera gets ready to shoot after the first image, and the final image one second after the camera gets ready to shoot after the second image.
Off	Self-timer is disabled.

1. In the REC mode, press [MENU].
2. On the “REC” tab, select “Self-timer” and then press [▶].
3. Use [▲] and [▼] to select the self-timer type and then press [SET].

This causes an indicator identifying the selected self-timer type to appear on the monitor screen.

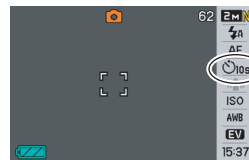

4. Press the shutter button to shoot.

NOTE

- You can also use the Panel (Operation Panel) (page 54) to change the self-timer setting.

Using the Self-timer to Shoot an Image

- The image is not shot right away after you press the shutter button. Instead, shooting starts after the preset time elapses. The AF assist/self-timer lamp flashes while the countdown is being performed.
- You can interrupt an ongoing self-timer countdown by fully pressing the shutter button while the self-timer lamp is flashing.

AF Assist/Self-timer Lamp

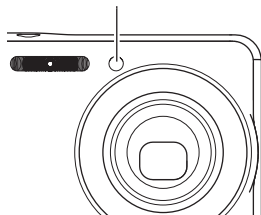





NOTE

- The indicator “1sec” appears on the monitor screen between Triple Self-timer shots. How long it takes for the camera to get ready to shoot again after it shoots an image depends on the image size and quality settings, whether or not a memory card is loaded in the camera, and the flash charge condition.
- You cannot use the any self-timer to shoot with Normal-speed continuous shutter mode.
- The Triple Self-timer cannot be used when performing the following recording operations.
 - Recording with certain BEST SHOT scenes (Business cards and documents, White board, etc., Old Photo)
 - Recording with High-speed Continuous Shutter or Flash Continuous Shutter

Using Continuous Shutter

Your camera has four continuous shutter modes.

Continuous Shutter Mode	Description
 Normal Speed (Normal-speed Continuous Shutter)	Continually records images until memory becomes full.
 High Speed (High-speed Continuous Shutter)	Record up to three consecutive images at high speed.
 Flash Cont. (Flash Continuous Shutter)	Use this mode to record up to three consecutive images, firing the flash for each one.
 Zoom Cont. (Zoom Continuous Shutter)	In this mode, you select an area on the monitor screen with a selection boundary. Then when you press the shutter button, the camera records the monitor screen image and the area enclosed in the selection boundary, digitally zoomed to twice its normal size.

Selecting the Continuous Shutter Mode

1. In the REC mode, press [MENU].
2. On the “REC” tab, select “Continuous” and then press [▶].
3. Use [▲] and [▼] to select the mode you want and then press [SET].

This enables the continuous shutter mode you selected and displays its icon on the monitor screen.

To turn off continuous shutter, select “Off”.

Recording with Normal-speed Continuous Shutter, High-speed Continuous Shutter, and Flash Continuous Shutter

1. Press the shutter button to shoot.

- With Normal-speed Continuous Shutter, images continue to be shot as long as you keep the shutter button depressed. Releasing the shutter button stops shooting.
- High-speed continuous shutter and flash continuous shutter can shoot up to three images. Shooting stops if you release the shutter button before three images are recorded.

IMPORTANT!

- The speed of normal-speed continuous shutter recording depends on the type of memory card loaded in the camera. When shooting to built-in memory, continuous shutter shooting is relatively slow.

Recording with Zoom Continuous Shutter

1. Use [▲], [▼], [◀], and [▶] to move the selection boundary around the image of the subject on the left side of the monitor screen until it is located at the part you want to enlarge, and then press [SET].

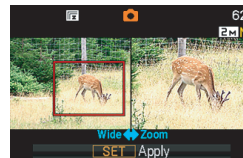

This will enlarge the area within the boundary and display it in the right side of the monitor screen.



2. Press the shutter button to shoot.

Both the left image and the right image will be recorded.

IMPORTANT!

- Note that with zoom continuous shutter, you do not need to keep the shutter button depressed.
- Digital zoom is disabled while shooting with zoom continuous shutter.
- Zoom continuous shutter is not available when the image size setting is 3:2 (3072 × 2048 pixels) or 16:9 (3072 × 1728 pixels).
- When the image size setting is 7M (3072 × 2304 pixels) or 5M (2560 × 1920 pixels), the size of the zoomed image produced by zoom continuous shutter is 3M (2048 × 1536 pixels).
- When Auto Focus is selected as the focus mode, the metering mode automatically switches to “Spot” (pages 116, 127) and locates the Auto Focus area in the center of the Zoom Continuous Shutter selection boundary.

Continuous Shutter Precautions

- Starting a continuous shutter operation causes the exposure and focus settings to be fixed at the levels for the first image. The same settings are applied to all subsequent images.
- Continuous shutter cannot be used in combination with any of the following features.
 - Some BEST SHOT scenes (Business cards and documents, White board, etc., Old Photo, Short Movie, Past Movie, Voice Recording)
 - Movie mode
- When using a continuous shutter mode, keep the camera still until all recording is finished.
- A continuous shutter operation may stop part way through if memory capacity runs low.
- The continuous shutter rate depends on the current image size and image quality settings.
- You can select the flash mode you want with normal-speed continuous shutter mode.
- With high-speed continuous shutter, the flash mode automatically becomes “” (flash off).
- With the flash continuous shutter mode, the flash mode automatically becomes “” (flash on).
- You cannot use the self-timer in combination with the normal-speed continuous shutter mode.
- Triple Self-timer can be used in combination with the zoom continuous shutter mode only.

- Note that the resolution of images recorded with the high-speed continuous shutter mode or flash continuous shutter mode is somewhat lower resolution and more prone to digital noise than images recorded with the normal-speed continuous shutter mode.
- “Auto” ISO sensitivity always is used for the flash continuous shutter mode, regardless of the current ISO sensitivity setting.
- With the flash continuous shutter mode, the flash range is narrower than normal.

Adding Audio to a Snapshot

You can add an audio recording to snapshots, if you want. Use this feature to add a verbal explanation or a description of the mood to a snapshot, or to capture the sounds of the people in the snapshot.

- You can record up to about 30 seconds of audio for a single snapshot.

■ Turning on Audio Snapshot

- 1. In the REC mode, press [MENU].**
- 2. On the “REC” tab, select “Audio Snap” and then press [▶].**
- 3. Use [▲] and [▼] to select “On” and then press [SET].**

■ Recording Audio for a Snapshot

1. Press the shutter button to shoot.

This monitor screen will show the image you just shot, along with the “” icon.

- If you do not want to record audio at this time, press [MENU]. This will display the monitor screen for shooting the next image.



Remaining Recording Time

2. Press the shutter button to start audio recording.

3. Press the shutter button again to stop audio recording.

Recording will stop automatically after about 30 seconds if you do not press the shutter button.

- To turn off the audio snapshot feature, select “Off” in step 3 of the procedure under “Turning on Audio Snapshot”.

Playing Back Snapshot Audio

Audio snapshots in the PLAY mode are indicated by the “” icon.

Press [SET] while an audio snapshot is displayed to play back its audio.

- For information about the playback operation, see page 143.



IMPORTANT!

- Audio snapshot capabilities are disabled while shooting with the Triple Self-timer or with a continuous shutter mode. You can, however, add audio to such a snapshot after you record it (page 173).

NOTE



- After transferring an audio snapshot to your computer's hard disk, you can play back the audio using Windows Media Player (page 228).
- The following shows the formats used for storing audio snapshot data.
 - Image Data: JPEG (.JPG extension)
 - Audio Data: WAVE/ADPCM (.WAV extension)
 - Approximate Audio File Size: 165 KB (30-second recording at 5.5KB per second)
- You cannot turn off the monitor screen by pressing [DISP] while audio recording is in progress.

SHOOTING A MOVIE

Movie Image Quality

Before shooting a movie, you should specify a movie image quality setting. Movie image quality is a standard that determines the detail, smoothness, and clarity of a movie during playback. Shooting with the high-quality (HQ) setting will result in better image quality, but it also shortens the amount of time you can shoot.

Image Quality (pixels)		Approximate Data Rate	Frame Rate
HQ	640 × 480	4.0 Megabits/second	30 frames/second
HQ Wide	704 × 384	4.0 Megabits/second	30 frames/second
Normal	640 × 480	2.1 Megabits/second	30 frames/second
Normal Wide	704 × 384	2.1 Megabits/second	30 frames/second
LP	320 × 240	745 Kilobits/second	15 frames/second

1. In the REC mode, press [MENU].
2. On the “Quality” tab, select “ Quality” and then press [▶].
3. Use [▲] and [▼] to select the quality setting you want and then press [SET].
 - The “ WIDE” indicator is on the monitor screen while “HQ Wide” or “Normal Wide” is selected for the quality setting.

Movie File Formats

Movies are recorded in MPEG-4 standard AVI format, DivX.

Movies you shoot with your camera can be played back on a computer using the following software.

- Windows Media Player
 - DivX Player (DivX Play Bundle)
- Movies you shoot with your camera cannot be played back on a Macintosh (page 235).



Movie Size

The following shows the approximate movie file size for a one-minute movie.

Image Quality	Approximate Size
HQ	28.4 MB
HQ Wide	28.4 MB
Normal	14.9 MB
Normal Wide	14.9 MB
LP	5.3 MB

Shooting a Movie

Audio is also recorded while you shoot a movie. Audio is monaural.

- 1. In the REC mode, point the camera at the subject.**
- 2. Press [●] to start shooting the movie.**
 - “REC” is displayed while movie recording is in progress.
- 3. Press [●] again to stop shooting.**

Remaining Recording Time



Recording Time



Shooting with BEST SHOT

With BEST SHOT (page 98), you select the preset scene that is closest to the one you want to shoot, and the camera sets up for it automatically. Selecting the “Night Scene” BEST SHOT scene, for example, sets the camera to shoot bright, clear images at night.

Anti Shake Movie Recording

You can also use Anti Shake to reduce the effects of hand movement only while recording a movie (page 104). The effects of subject movement are not limited.

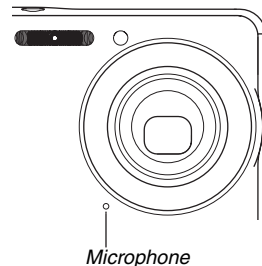
Movie Recording Precautions

- You cannot use flash while shooting a movie.
- The camera also records audio. Note the following points when shooting a movie.
 - Take care that the microphone is not blocked by your fingers, etc.
 - Good results are not possible when the camera is too far away from what you are trying to record.
 - Operating camera buttons while shooting can cause button noise to be picked up in the audio.
- Shooting a very bright subject can cause a vertical band to appear in the monitor screen image. This does not indicate malfunction. The band will not be recorded in a snapshot, but will be recorded in the case of a movie.
- Certain types of memory cards take longer to record data, which can cause movie frames to be dropped. “A line drawing of the front of a camera, focusing on the lens and microphone area. The lens is a large circular element with concentric rings. Above the lens, there is a small circular microphone hole. A line points from the word "Microphone" to this hole. To the left of the lens, there is a small rectangular button. The camera body is shown in profile on the right side.

- You can perform digital zoom while shooting a movie by pressing [Z]. Optical zoom is not available while shooting a movie. To use optical zoom for a movie, use [Z] to zoom as required first and then press [●] to start recording.
- The effects of camera movement in an image become more pronounced when you shoot close up or a large zoom factor. Because of this, use of a tripod is recommended under these conditions.
- When the subject is outside the camera's focus range, focusing is not possible and the image will be out of focus.
- Auto Focus and Macro Focus become fixed focus while shooting a movie (pages 113, 114).

Using Short Movie

With Short Movie, pressing [●] will shoot a movie that starts a few seconds before [●] is pressed (first part) and ends a few seconds after it is pressed (second part). You can specify how long (in seconds) you want the first part and the second part of the Short Movie to be.

- Since a few seconds of action before [●] is pressed are recorded, Short Movie is a good way to make sure you don't miss the action of kids or other active subjects.
- You can also use MOTION PRINT (page 171) to extract still images of Short Movie scenes.

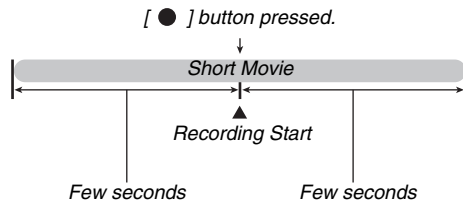

■ Getting Ready to Shoot with Short Movie

1. In the REC mode, press [BS].

2. Use [▲], [▼], [◀], and [▶] to select the “Short Movie” scene and then press [SET].

This causes “” to appear on the monitor screen.

Pressing [●] at this point will shoot a Short Movie with a 4-second first part and a 4-second second part.

If you want to configure settings for the length of the first part, the length of the second part, or MOTION PRINT settings, continue from step 3.

3. Press [SET].

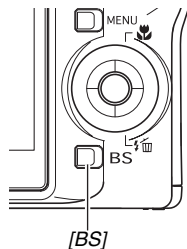

4. Use [▲] and [▼] to select how long (in seconds) you want the first part of the Short Move to be and then press [▶].

5. Use [▲] and [▼] to select how long (in seconds) you want the second part of the Short Move to be and then press [▶].

The total length of a Short Movie (first part plus second part) must be at least two seconds and no longer than eight seconds.

If you specify five seconds for the first part in step 4, for example, you can specify no more than three seconds for the second part. Specifying a value greater than three, in this case, will cause the length specified for the first part to be reduced automatically.

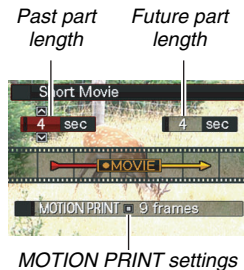

6. Use [◀] and [▶] to select the MOTION PRINT setting you want and then press [SET].

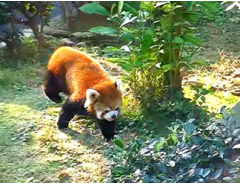
To do this:	Select this setting:
Create a snapshot with nine movie frames, with the one recorded when [●] is pressed in the center	9 frames 
Create a snapshot of the frame recorded when [●] is pressed	1 frame 
Turn off MOTION PRINT	Off

■ Shooting a Short Movie

1. With the camera pointed at the subject, press [●].

This will shoot a Short Movie of the length you specified and then stop shooting automatically.

To stop shooting before the specified time is up, press [●] again.

 **IMPORTANT!**

- Movie data is continually recorded and stored in a buffer before you press [●]. Keep the camera pointed at the subject. Then at the right moment, press [●]. When you press [●], the remaining recording time of part two of the Short Movie counts down on the monitor screen.

To return to the REC mode

After Short Movie recording is complete, the camera stands by for shooting of another Short Movie.

To exit Short Movie recording, press [BS], select something other than “Short Movie” and then press [SET]. If you want to set the camera up for normal snapshot shooting, for example, select “Auto” and then press [SET].

Using Past Movie

Past Movie is similar to a normal movie, except that it captures about five seconds of whatever happened in front of the lens before [●] was pressed to start shooting. Past Movie is a great way to make sure that you never just miss that special moment because you press the [●] button too late.

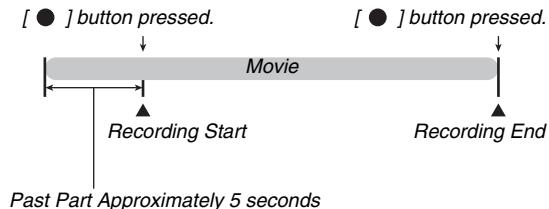

■ Getting Ready to Shoot with Past Movie

1. In the REC mode, press [BS].

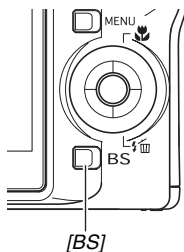

2. Use [▲], [▼], [◀], and [▶] to select the “Past Movie” scene and then press [SET].

This causes “” to appear on the monitor screen, which indicates that Past Movie is enabled.

■ Shooting a Past Movie

1. With the camera pointed at the subject, press [●].
2. Press [●] again to stop shooting.

Movie recording also will stop automatically if memory becomes full before you press [●].

To return to the REC mode

After Past Movie recording is complete, the camera stands by for shooting of another Past Movie.

To exit Past Movie recording, press [BS], select something other than “Past Movie” and then press [SET]. If you want to set the camera up for normal snapshot shooting, for example, select “Auto” and then press [SET].

Shooting a Snapshot while Shooting a Movie (Snapshot-In-Movie)

You can shoot a snapshot while normal movie recording is in progress. Note, however, that movie recording (image and audio) is interrupted for a few seconds while the snapshot is recorded.

■ Shooting a Snapshot During a Movie

1. While movie recording is in progress, press the shutter button.

You can also half-press the shutter button to focus using Auto Focus.



2. Movie recording continues after the snapshot is recorded.

3. To stop movie recording, press [●].

IMPORTANT!

- Shooting a snapshot while shooting a movie is not supported while any one of the following BEST SHOT scenes is selected.
Short Movie, Past Movie, Business cards and documents, White board, etc., Voice Recording.

NOTE

- You can use [▼] ( ) while shooting a movie to change the flash mode.

USING BEST SHOT

With BEST SHOT, you simply select the sample scene that is like the one you are trying to shoot, and the camera sets up automatically. Even difficult backlight scenes (which result in the main subject being too dark if set up improperly) come out looking great!

■ Some Sample Scenes

- Portrait



- Scenery



- Night Scene



- Night Scene Portrait



■ Selecting a Sample Scene



1. In the REC mode, press [BS].

This enters the BEST SHOT mode and displays a screen showing thumbnails of 15 sample scenes.

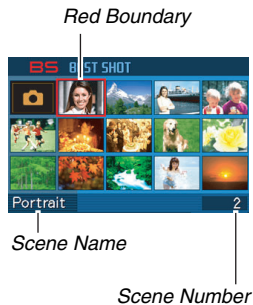
- The currently selected sample scene is the one with the red boundary around it.
- The initial default selection is “” (Auto).



2. Use [▲], [▼], [◀], and [▶] to move the boundary to select the scene you want to select.

- Pressing [▲] or [▼] while the red boundary is at the edge of the screen will scroll to the next screen of BEST SHOT scenes.
- Pressing the zoom button will display text that explains the settings configured by the selected scene. Press the zoom button again to return to the scene selection screen.
- To return to “Auto”, select Scene 1, which is “” (Auto). Pressing [MENU] while the scene selection screen or scene description text is on the monitor screen will cause the red boundary to jump directly to “” (Auto).

3. Press [SET] to apply the settings of the selected scene and return to the recording screen.

- The settings of the scene you selected remain in effect until you select a different scene.
- To select a different BEST SHOT scene, repeat the above procedure from step 1.

4. Press the shutter button (if you are shooting a snapshot) or [●] (if you are shooting a movie).

BEST SHOT Scene Limitations

- Business cards and documents, White board, etc., and Old Photo.
These scenes cannot be used to shoot a movie.
- Short Movie, Past Movie
These scenes cannot be used to shoot a snapshot.
- Voice Recording
These scenes cannot be used to shoot a snapshot or movie.
- Night Scene, Fireworks
These scenes use slow shutter speeds. Since a slow shutter speed increases the chance of digital noise in the image, the camera automatically performs a digital noise reduction process on slow shutter images. Because of this, such images take longer to store after you press the shutter button. Do not perform any key operation while an image is being stored. Also, it is a good idea to use a tripod to avoid image blur due to camera movement when shooting at slow shutter speeds.



IMPORTANT!

- BEST SHOT scenes were not shot using this camera.
- Images shot using a BEST SHOT scene may not produce the results you expected due to shooting conditions and other factors.
- You can change the camera settings that are made when you select a BEST SHOT scene. Note, however, that the BEST SHOT settings revert to their defaults when you select another BEST SHOT scene or turn off the camera. If you think you will later need to use a particular camera setup you configured, save it as a BEST SHOT user setup (page 102).

Displaying Detailed Information about a BEST SHOT Scene

Though the name of each BEST SHOT scene is displayed as you move the selection boundary around the 15-scene selection screen, there may be times when you need more information about a scene's setup. To find out more about a scene, select it with the red boundary on the scene selection screen and then press the zoom button.

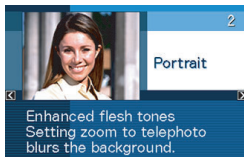

The following are the different operations you can perform while the scene description screen is on the display.

- To return to the scene selection screen, press the zoom button again.
- To scroll through available BEST SHOT scenes, use [◀] and [▶].
- To select the currently displayed scene and configure the camera with its settings, press [SET].

NOTE

- If you select a scene by pressing [SET] while the description screen is displayed, the same description scene will appear the next time you press [BS] to view BEST SHOT sample scenes.

■ Creating Your Own BEST SHOT Scenes

You can use the procedure below to save the setups of snapshots or movies that you shot as BEST SHOT scenes. After that, you can recall a setup whenever you want to use it.

1. In the REC mode, press [BS].
2. Use [▲], [▼], [◀], and [▶] to select “BEST SHOT” (Register User Scene) and then press [SET].
3. Use [◀] and [▶] to select the snapshot or movie whose setup you want to register.
4. Use [▲] and [▼] to select “Save” and then press [SET].

Your BEST SHOT scene will be assigned the name “Recall User Scene”, along with a scene number.

IMPORTANT!

- Formatting the camera’s built-in memory (page 199) deletes all the user BEST SHOT scene files.



NOTE

- Registering a snapshot creates a snapshot setup, while registering a movie creates a movie setup. A snapshot setup can be used to shoot snapshots only, and a movie setup can be used to shoot movies only.
- You can check the settings of the currently selected BEST SHOT scene by displaying the camera’s setting menus and looking at its settings.
- User snapshot scenes are assigned numbers sequentially in the sequence: SU1, SU2, and so on, while movies are assigned numbers in the sequence: MU1, MU2, and so on.
- The following are the settings that are included in a user snapshot scenes:
Focus, EV Shift, White Balance, Flash, ISO, Metering, Flash Intensity, Flash Assist, Filter, Sharpness, Saturation, Contrast

- The following are the settings that are included in a user movie scene:
Focus, EV Shift, White Balance, Filter, Sharpness, Saturation, Contrast
- You can store up to 999 BEST SHOT user scenes.
- User snapshot scenes are stored in camera built-in memory in the folder named "SCENE" (page 246).

Deleting a BEST SHOT User Scene

Perform the following steps when you want to delete a BEST SHOT user scene.

- 1. In the REC mode, press [BS].**
- 2. Press the zoom button to display its explanation screen.**
- 3. Use [◀] and [▶] to select the BEST SHOT user scene you want to delete.**
- 4. Press [▼] ( ).**
- 5. Use [▲] and [▼] to select "Delete" and then press [SET].**
This will delete the BEST SHOT user scene you selected and display the next screen (either the next user scene or the Register User Scene).
- 6. Use [◀] and [▶] to select another scene and then press [SET].**
 - This returns to the recording state.

Reducing the Effects of Hand and Subject Movement

You can turn on the camera's Anti Shake feature to reduce image blur due to subject movement or hand movement when shooting a moving subject using telephoto, when shooting a fast-moving subject, or when shooting under dim lighting conditions.

You can turn on Anti Shake using BEST SHOT or by performing a menu operation.

■ Turning on Anti Shake Using BEST SHOT

1. In the REC mode, press [BS].
2. Use [▲], [▼], [◀], and [▶] to select the “Anti Shake” scene and then press [SET].

Anti Shake will remain selected until you select a different BEST SHOT scene.

■ Turning on Anti Shake Using the Menu

1. In the REC mode, press [MENU].
2. On the “REC” tab, select “Anti Shake” and then press [▶].
3. Use [▲] and [▼] to select “Auto” and then press [SET].
 - This turns on Anti Shake and displays “” on the monitor screen.
 - In this case, Anti Shake will remain on until you turn it off on the menu.

NOTE

- You can also use the Panel (Operation Panel) (page 54) to change the Anti Shake setting.

★ IMPORTANT!

- Anti Shake will not work unless the ISO setting (page 126) is set to “Auto”.
- Shooting with Anti Shake can cause an image to appear somewhat coarser than normal and can cause slight deterioration of image resolution.
- Anti Shake may not be able to eliminate the effects of hand or subject movement when movement is severe.
- You can also use Anti Shake to reduce the effects of hand movement only while recording a movie. The effects of subject movement are not limited (page 89).
- Anti Shake may not work with a very low shutter speed. If this happens, use a tripod to stabilize the camera.
- Though “” (Anti Shake) is displayed on the monitor screen following an automatic flash operation using the “Auto Flash” or “Red Eye” setting, or while the flash setting is “Flash On” or “Soft Flash”, Anti Shake is disabled.
- The camera sometimes performs an automatic noise reduction operation to reduce digital noise in images recorded under certain lighting conditions. This operation causes the camera to take longer than normal to store the image and be ready for the next shot.

Taking Bright Images without Flash

The BEST SHOT “High Sensitivity” scene makes it possible for you to take natural looking images without using the flash, even when lighting is low



Normal Snapshot (With flash) Snapshot with High Sensitivity

- 1. In the REC mode, press [BS].**
- 2. Use [▲], [▼], [◀], and [▶] to select the “High Sensitivity” scene and then press [SET].**
- 3. Press the shutter button to shoot the image.**
High Sensitivity will remain selected until you select a different BEST SHOT scene.

IMPORTANT!

- Shooting with High Sensitivity can cause an image to appear somewhat coarser than normal and can cause slight deterioration of image resolution.
- The desirable level of image brightness may not be possible under very dark conditions.
- When shooting with slow shutter speeds, use a tripod to protect against the effects of hand movement.
- High Sensitivity is disabled following an automatic flash operation using the “Auto Flash” or “Red Eye” setting, or while the flash setting is “Flash On” or “Soft Flash”.
- The camera sometimes performs an automatic noise reduction operation to reduce digital noise in images recorded under certain lighting conditions. This operation causes the camera to take longer than normal to store the image and be ready for the next shot.

Shooting Images of Business Cards and Documents (Business Shot)

Shooting a business card, document, whiteboard, or similarly shaped object from an angle can cause the subject to appear misshaped in the resulting image. The BEST SHOT Business Shot scenes correct the shape of rectangular objects so they appear natural.

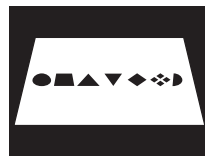

Before Keystone Correction

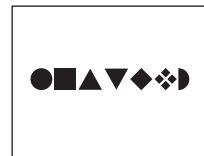

After Keystone Correction

BEST SHOT has two Business Shot scenes from which to choose.

- Business cards and documents
- White board, etc.

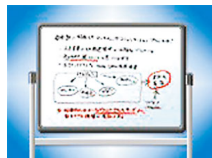

■ Selecting a Business Shot Scene

1. In the REC mode, press [BS].
2. Use [▲], [▼], [◀], and [▶] to select the “Business cards and documents” or the “White board, etc.” scene and then press [SET].

Whichever you select will remain in effect until you select a different BEST SHOT scene.

■ Shooting an Image Using a Business Shot Scene

1. After selecting either of the BEST SHOT Business Shot scenes, compose the image and press the shutter button to shoot.

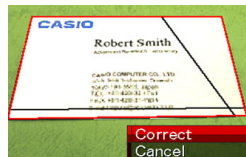

This displays a screen that shows all of the rectangular shapes in the image that qualify as candidates for keystone correction.

A red boundary will surround the currently selected correction candidate. If there is a black boundary, it means that the black boundary is indicating a second possible candidate. If there is no second candidate (black boundary), jump directly to step 3.

- If the camera is unable to detect any keystone correction candidate at all, the message “Cannot correct image!” will appear on the monitor screen momentarily and then the camera will save the image as-is (uncorrected).

2. Use [◀] and [▶] to select the candidate you want to use for correction.

3. Use [▲] and [▼] to select “Correct” and then press [SET].

This will correct the image and store the resulting (corrected) image.

- To cancel the correction operation, select “Cancel”.



IMPORTANT!

- Make sure the entire object you are trying to shoot (correct) is enclosed within the monitor screen. The camera will not be able to detect the shape of the object correctly unless it is enclosed entirely within the monitor screen.
- Correction will not be possible if the subject is the same color as its background. Make sure the object is against a background that allows its outline to stand out.
- Digital zoom is disabled while shooting with a Business Shot scene. However, you can use optical zoom.
- The maximum Business Shot image size is 2M (1600 × 1200 pixels), even if the camera is configured for a larger image size. When the camera is configured to record images smaller than 2M (1600 × 1200 pixels), Business Shot scenes will produce images in accordance with the currently specified image size.

Restoring an Old Photograph

With Old Photo, you can record the image of an old, faded photograph and then use the camera's built-in advanced digital camera technology to restore it.

■ Before Recording with Old Photo

- Make sure the entire photograph you are trying to record is enclosed within the monitor screen.
- Make sure the photograph is against a background that allows its outline to stand out, and that it fills the monitor screen to the maximum extent possible.
- Make sure that light is not reflecting off the surface of the original photograph when recording it.
- If the old photograph is portrait orientation, be sure to compose the image with the camera in landscape (horizontal) orientation.

NOTE

- When the camera is at an angle to the photograph you are recording, the shape of the photograph may appear distorted in the recorded image. Auto keystone correction corrects for this distortion, which means that a photograph appears normal even if you record it at an angle.

■ Selecting the Old Photo Scene

1. In the REC mode, press [BS].
2. Use [▲], [▼], [◀], and [▶] to select the “Old Photo” scene and then press [SET].
“Old Photo” will remain selected until you select a different BEST SHOT scene.

■ Recording an Image with Old Photo

1. Press the shutter button to shoot the image.

- This displays a photograph contour confirmation screen and then saves the original recorded image. An error message will appear (page 276), without displaying the photograph contour confirmation screen, if the camera is unable to find the contour of the photograph.

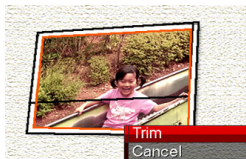

2. Use [◀] and [▶] to select the candidate you want to correct.

3. Use [▲] and [▼] to select “Trim” and then press [SET].

This displays a cropping boundary on the monitor screen.

- To cancel the correction operation, select “Cancel”.



4. Press the zoom button to zoom the cropping boundary.

5. Use [▲], [▼], [◀], and [▶] to move the cropping boundary to the location you want and then press [SET].

The camera will correct color automatically and save the corrected image.

- If you do not want a border around the image, configure the cropping boundary so it is slightly inside of the boundary of the displayed image.
- To cancel the cropping operation at any point and save the image as-is, press [MENU].



IMPORTANT!

- Digital zoom is disabled while recording with Old Photo. However, you can use optical zoom.
- When recording the image of a photograph, the camera will not be able to recognize the shape of the photograph in the following cases.
 - When part of the photograph extends outside of the monitor screen
 - When the subject is the same color as the background it is placed upon
- The maximum Old Photo image size is 2M (1600 × 1200 pixels). When the camera is configured to record images smaller than 2M (1600 × 1200 pixels), Old Photo will produce images in accordance with the currently specified image size.
- Under certain conditions, restored colors may not produce the desired results.

ADVANCED SETTINGS

Changing the Focus Mode

Your camera provides you with the five focus modes described below. The initial factory default focus mode is Auto Focus.

Focus Mode	Description	Focus Range						
AF Auto Focus	Automatic focus when the shutter button is half-pressed.	Auto adjustment (Approximately 40 cm to ∞ (1.3' to ∞))						
MF Macro (Close-up)	Automatic focus for distances that are closer than those for Auto Focus. Used for close-up shooting.	Auto adjustment (15 cm to 50 cm (5.9" to 19.7")) <ul style="list-style-type: none">• Minimum distance position varies with optical zoom.						
PF Pan Focus	Fixed focus for relatively wide-range focusing. Use Pan Focus (PF) under conditions where Auto Focus is difficult.	Fixed distance <ul style="list-style-type: none">• Focus range varies with optical zoom position.						
∞ Infinity Focus	Focus is fixed at infinity. Use this mode when shooting scenery and other faraway images.	Infinity						
MF Manual Focus	Focus is performed manually.	<ul style="list-style-type: none">• Focus range varies with optical zoom factor. <table border="1"><thead><tr><th>Optical Zoom Factor</th><th>Range</th></tr></thead><tbody><tr><td>1X</td><td>15cm to ∞ (0.5' to ∞)</td></tr><tr><td>3X</td><td>40cm to ∞ (1.3' to ∞)</td></tr></tbody></table>	Optical Zoom Factor	Range	1X	15cm to ∞ (0.5' to ∞)	3X	40cm to ∞ (1.3' to ∞)
Optical Zoom Factor	Range							
1X	15cm to ∞ (0.5' to ∞)							
3X	40cm to ∞ (1.3' to ∞)							

Perform the following steps to change the focus mode.

1. In the REC mode, press [▼] (🔍) twice.
2. Use [◀] and [▶] to select the focus mode setting you want and then press [SET].
 - See the following pages of this section for details about shooting with each focus mode.

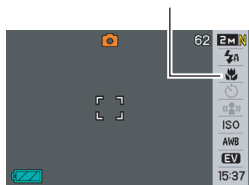
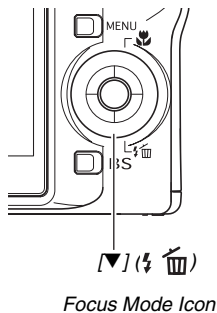

NOTE

- If you are using the “Normal” Screen Layout setting (page 54), each press of [▲] (🌸) will cycle through the available focus mode settings.

Using Auto Focus

1. Align the monitor screen's focus frame with the subject you want to focus and then half-press the shutter button.

This camera will perform the focus operation.

You can tell if the image is in focus by checking the operation lamp and the focus frame color.

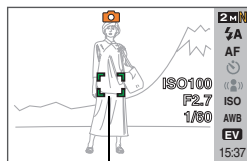

Focus Frame

Operation Lamp

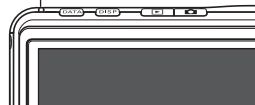

Status	Operation Lamp	Focus Frame
Focusing Complete	Lit Green	Green
Not Focused	Flashing Green	Red

2. When the image is focused, press the shutter button the rest of the way to shoot.

IMPORTANT!

- Auto Focus and Macro Focus become fixed focus while shooting a movie.

NOTE

- When proper focusing is not possible because the subject is closer than the Auto Focus range, the camera will switch to the Macro Focus range automatically (Auto Macro).
- Whenever you perform an optical zoom operation while shooting with Auto Focus, a value will appear on the monitor screen as shown below to tell you the focus range.

Example: ○○ cm – ∞

* ○○ will be replaced by the actual focus range value.

Using Macro Focus

1. Half-press the shutter button to focus the image.

The focus operation is the same as that for Auto Focus.

2. When the image is focused, press the shutter button the rest of the way to shoot.

IMPORTANT!

- Use of the flash along with Macro Focus can cause the light of the flash to become blocked, which can produce unwanted lens shadows in your image.
- Auto Focus and Macro Focus become fixed focus while shooting a movie.

NOTE

- When Macro Focus cannot focus properly because the subject is too far away, the camera will switch to the Auto Focus range automatically (Auto Macro).
- Whenever you perform an optical zoom operation while shooting with Macro Focus, values will appear on the monitor screen as shown below to tell you the focus range.

Example: ○○ cm – ○○ cm

* ○○ will be replaced by the actual focus range values.

Auto Focus and Macro Focus Shooting Tips

Changing the Auto Focus Area

Use the following procedure to change the metering area used for Auto Focus (AF).

1. In the REC mode, press [MENU].
2. On the “REC” tab, select “AF Area” and then press [▶].
3. Use [▲] and [▼] to select the setting you want and then press [SET].

To do this:	Select this setting:
Use a small area in the center of the screen for metering <ul style="list-style-type: none">• This setting is best when you want to use focus lock (page 117).	[•] Spot
When the shutter button is half-pressed, have the camera automatically select one or more of nine possible focus frames <ul style="list-style-type: none">• If the camera is able to focus on multiple points, all applicable focus frames turn green.	[#] Multi

NOTE

- When you select “[#] Multi” as the focus area, nine focus frames appear on the monitor screen. The camera will automatically determine the optimum focus frame(s), which will change to green on the monitor screen.

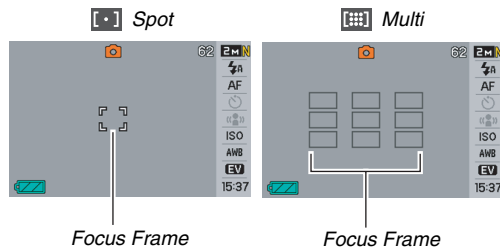

Using Focus Lock

“Focus lock” is the name of a technique you can use when you want to shoot an image in which the subject to be focused on is not within the focus frame in the center of the screen.

- Use focus lock with “[] Spot” focus.

1. Align the monitor screen’s focus frame with the subject you want to focus on and then half-press the shutter button.

Subject to be focused on

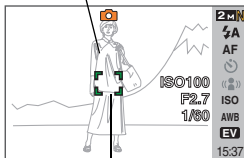

Focus Frame

2. Keeping the shutter button half-pressed, re-compose the image as you like.

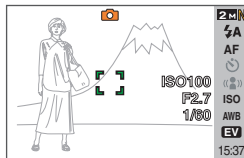

3. When the image is focused, press the shutter button the rest of the way to shoot.

NOTE

- Focus lock also causes exposure (AE) to be locked.

Quick Shutter

When Quick Shutter is turned on, the camera immediately shoots the image without waiting for Auto Focus to be performed when you press the shutter release all the way down. This helps to avoid missing a special moment while you wait for the camera to Auto Focus.

1. In the REC mode, press [MENU].
2. On the “REC” tab, select “Quick Shutter” and then press [▶].
3. Use [▲] and [▼] to select the setting you want and then press [SET].

To do this:	Select this setting:
Turn on Quick Shutter	On
Turn off Quick Shutter	Off

4. Press the shutter button all the way down without pausing.

Pressing the shutter button all the way without pausing at the halfway type records with Quick Shutter, with no Auto Focus.

Using Fixed Focus (Pan Focus)

Pan Focus (PF) fixes focus for a relatively wide focus range, which means you can shoot without waiting for the Auto Focus operation to finish.

1. When you are ready to shoot, press the shutter button all the way, without pausing.

Using Infinity Focus

As its name suggests, Infinity Focus fixes focus at infinity (∞). Use this mode when shooting scenery and other faraway subjects. Infinity Focus also comes in handy when shooting from a car or train window, or when shooting scenery or other subjects that are difficult to focus properly with Auto Focus.

- 1. While Infinity Focus is selected as the focus mode, press the shutter button to shoot.**

Using Manual Focus

With Manual Focus, the camera automatically enlarges the subject on the monitor screen, which helps you manually adjust focus. Manual focus can be used for shoot such images as moving trains. Before the train arrives, manually focus on an electric pole or some other object. Then when the train passes the object you focused on, you can shoot without worrying about focus.

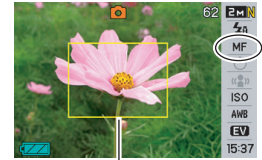

Yellow Boundary

- 1. While Manual focus is selected as the focus mode, compose the image on the monitor screen so the subject you want to focus on is within the yellow boundary.**

2. Use [◀] and [▶] to focus the image, as you view the results on the monitor screen.

At this time the image that is within the boundary will enlarge and fill the monitor screen, which aids in focusing.

For this:	Press this button:
Closer focus	[◀]
More distant focus	[▶]

- The monitor screen will return to step 1 if you do not perform any operation for about two seconds.

3. Press the shutter button to shoot.

NOTE

- Whenever you perform an optical zoom operation (page 72) while shooting with manual focus, a value will appear on the monitor screen as shown below to tell you the focusing range.

Example: MF ○○ cm – ∞

* ○○ will be replaced by the actual focus range values.



IMPORTANT!

- While Manual Focus is selected as the focus mode, the [◀] and [▶] keys are used to adjust the focus setting. Any other functions assigned to the [◀] and [▶] keys with Key Customize (page 135) are not performed when you press the keys during manual focus.

Correcting Image Brightness (EV Shift)

You can manually adjust an image's exposure value (EV value) before shooting it. This feature helps to achieve better results when shooting a backlit subject, a strongly lit subject indoors, or a subject that is against a dark background.

Exposure Compensation Value: -2.0EV to $+2.0\text{EV}$

Unit: $1/3\text{EV}$

1. In the REC mode, press [MENU].

2. On the "Quality" tab, select "EV Shift" and then press [SET].



EV Shift Value

3. Use [▲] and [▼] to adjust the exposure compensation value.

[▲]: Increases the EV value. A higher EV value is best used for light-colored subjects and backlit subjects.

* Increasing the EV value also works well with the BEST SHOT "Backlight" scene.

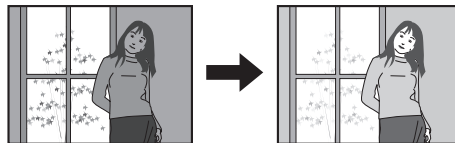

[▼]: Decreases the EV value. A lower EV value is best for dark-color subjects and for shooting outdoors on a clear day.

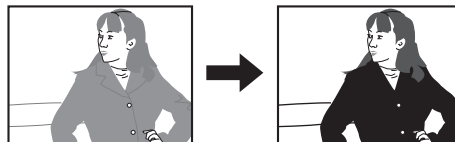

To cancel exposure compensation, adjust the value until it becomes 0.0.

4. After the EV value is the way you want, press [SET] to apply it.

The exposure compensation value you set remains in effect until you change it.

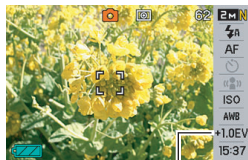

EV Shift Value

IMPORTANT!

- When shooting under very dark or very bright conditions, you may not be able to obtain satisfactory results even after performing exposure compensation.

NOTE

- You can also use the Panel (Operation Panel) (page 54) to change the EV shift setting.
- Performing an EV shift operation while using multi-pattern metering will cause the metering mode to switch automatically to center weighted metering. The metering mode will return to multi-pattern metering when you change the exposure compensation value to 0.0 (page 127).
- You can use the key customization feature to configure the [◀] and [▶] buttons so they control the metering mode setting (page 135). This comes in handy when adjusting exposure compensation while viewing the on-screen histogram (page 132).

Controlling White Balance

Shooting on a cloudy day can give your subject a blue cast, while shooting under white fluorescent lighting can give your subject a green cast. White balance corrects for different types of lighting so the colors in your images always look natural.

1. In the REC mode, press [MENU].
2. On the “Quality” tab, select “White Balance” and then press [▶].
3. Use [▲] and [▼] to select the white balance setting you want and then press [SET].

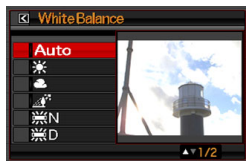

To do this:	Select this setting:
Let the camera adjust white balance automatically	Auto
Shoot outdoors on a clear day	Daylight
Shoot outdoors on an overcast rainy day, in the shade, etc.	Overcast
Shoot in the shadow of a building, in the shade of trees, etc. on a clear day	Shade
Suppress color cast when shooting under white or day white fluorescent lighting	Day White Fluorescent
Suppress color cast when shooting under daylight fluorescent lighting	Daylight Fluorescent
Suppress the appearance of light bulb lighting	Tungsten
Manually adjust white balance to suit a particular light source <ul style="list-style-type: none"> • For details, see “Configuring the White Balance Setting Manually” (page 124). 	Manual

NOTE

- You can also use the Panel (Operation Panel) (page 54) to change the white balance setting.
- When “Auto” is selected for the white balance setting, the camera automatically determines the white point of the subject. Certain subject colors and light source conditions can cause problems when the camera tries to determine the white point, which makes proper white balance adjustment impossible. If this happens, select the white balance setting that matches your shooting conditions (Daylight, Overcast, etc.)
- You can use the key customization feature to configure the [◀] and [▶] buttons so they control the white balance setting (page 135).
- To select “Auto” with the control key (when the control key is configured to select the auto white balance setting), scroll through the settings until “AWB” appears on the monitor screen.

■ Configuring the White Balance Setting Manually

Under complex lighting conditions, the preset white balance settings may not be able to produce natural looking colors. When this happens, you can configure the white balance setting manually for particular lighting conditions. Note that you will need to have a plain white sheet of paper on hand when performing the following procedure.

- 1. In the REC mode, press [MENU].**
- 2. On the “Quality” tab, select “White Balance” and then press [▶].**
- 3. Use [▲] and [▼] to select “Manual”.**

This will display the subject that the lens is aimed at on the monitor screen using the current manual white balance settings. If you want to use the current settings, jump directly to step 5.

4. Under the lighting conditions you plan to use when shooting, point the camera at a blank white piece of paper so it fills the entire monitor screen and then press the shutter button.

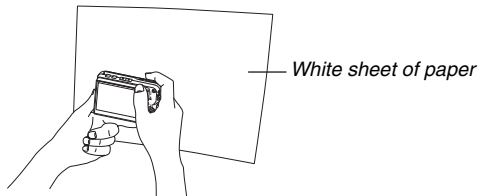

The camera will adjust white balance settings for the current conditions, and display "Complete" when it is finished.

5. Press [SET] to register the white balance settings and return to the shooting screen.

NOTE

- After you adjust white balance manually, the setting remains in effect until you change it or until you turn off the camera.

Specifying ISO Sensitivity

ISO sensitivity is a value that expresses sensitivity to light. A larger value indicates higher sensitivity, which is better for shooting when available lighting is dim. If you want to use faster shutter speeds, you should use a higher ISO sensitivity value. Under certain conditions, a fast shutter speed in combination with a high ISO sensitivity setting can cause digital noise, which makes an image appear rough. For clean, good-quality images, use the lowest possible ISO sensitivity setting.

1. In the REC mode, press [MENU].
2. On the “Quality” tab, select “ISO” and then press [▶].

3. Use [▲] and [▼] to select the setting you want and then press [SET].

To shoot with this level of sensitivity:	Select this setting:
Automatically selected by camera.	Auto
Low ↑ ↓ High	ISO 50
	ISO 100
	ISO 200
	ISO 400

NOTE

- You can also use the Panel (Operation Panel) (page 54) to change the ISO sensitivity setting.

IMPORTANT!

- Using flash with high ISO sensitivity can cause problems with subjects that close to the camera.
- “Auto” ISO sensitivity always is used for movies, regardless of the current ISO sensitivity setting.
- You can use the key customization feature to configure the [◀] and [▶] buttons so they control the ISO sensitivity setting (page 135).

Specifying the Metering Mode

The metering mode determines what part of the subject is metered for exposure.

- 1. In the REC mode, press [MENU].**
- 2. On the “Quality” tab, select “Metering” and then press [▶].**
- 3. Use [▲] and [▼] to select the setting you want and then press [SET].**

Multi (Multi Metering)

Multi-pattern metering divides the image into sections and measures the light in each section for a balanced exposure reading. The camera automatically determines shooting conditions according to the measured lighting pattern, and makes exposure settings accordingly. This type of metering provides error-free exposure settings for a wide range of shooting conditions.



Center Weighted

Center weighted metering concentrates on the center of the focus area to measure light. Use this metering method when you want to exert some control over exposure, without leaving settings totally up to the camera.



Spot

Spot metering takes readings at a very small area. Use this metering method when you want exposure to be set according to the brightness of a particular subject, without being affected by surrounding conditions.



IMPORTANT!

- The metering mode will change to “Center Weighted” automatically if you change the EV shift value (page 121) to anything other than 0.0 while “Multi” is selected. The metering mode will change back to “Center Weighted” when the EV shift value is changed back to 0.0.
- When “Multi” is selected as the metering mode, the  icon will not be displayed on the monitor screen when you return to the REC mode information display (page 260).

NOTE

- You can use the key customization feature to configure the [◀] and [▶] buttons so they control the metering mode setting (page 135).

Using the Camera's Filter Effects

The camera's filter feature lets you add color tints to your images as you shoot them. The color effect look just like what you would get by installing a color filter on the lens of the camera.

1. In the REC mode, press [MENU].
2. On the "Quality" tab, select "Filter" and then press [▶].
3. Use [▲] and [▼] to select the setting you want and then press [SET].

Available filter settings are: Off, B/W, Sepia, Red, Green, Blue, Yellow, Pink, and Purple

Controlling Image Sharpness

Use the following procedure to adjust the sharpness of subject outlines in your images.

1. In the REC mode, press [MENU].
2. On the "Quality" tab, select "Sharpness" and then press [▶].
3. Use [▲] and [▼] to select the setting you want and then press [SET].

You can specify one of five sharpness settings from +2 (sharpest) to -2 (least sharp).

Controlling Color Saturation

Use the following procedure to adjust the saturation of colors in your images.

- 1. In the REC mode, press [MENU].**
- 2. On the “Quality” tab, select “Saturation” and then press [▶].**
- 3. Use [▲] and [▼] to select the setting you want and then press [SET].**

You can specify one of five saturation settings from +2 (most saturated) to -2 (least saturated).

Adjusting Image Contrast

Use the following procedure to adjust the contrast of your images.

- 1. In the REC mode, press [MENU].**
- 2. On the “Quality” tab, select “Contrast” and then press [▶].**
- 3. Use [▲] and [▼] to select the setting you want and then press [SET].**

You can specify one of five contrast settings from +2 (most contrast between light and dark) to -2 (least contrast between light and dark).

Date Stamping Snapshots

You can have the snapshot's recording date only, or date and time stamped in the lower right corner of the image.

1. In the REC mode, press [MENU].
2. On the "Set Up" tab, select "Timestamp" and then press [▶].
3. Use [▲] and [▼] to select the setting you want and then press [SET].

Example: December 24, 2006, 1:25 p.m.

To do this:	Select this setting:
Display the date only (2006/12/24)	Date
Display the date and time (2006/12/24 1:25pm)	Date&Time
Display nothing	Off

IMPORTANT!

- Once date and time information is stamped in a print, it cannot be edited or deleted.
- Use the "Date Style" setting (page 194) to specify the Year/Month/Day format of the date.
- The recording date and time are determined in accordance with the camera's clock settings (pages 12, 193) when the snapshot is recorded.
- Digital zoom is not supported while date stamping is turned on.
- Date stamping is not supported for the following types of images.
 - Some BEST SHOT images (Business cards and documents, White board, etc., Old Photo)
 - Images recorded with Zoom Continuous Shutter

Using the On-screen Histogram to Check Exposure

The on-screen histogram that provides a graphic representation of the current exposure of the image. You can also display the histogram in the PLAY mode for information about the exposure levels of images.



1. Select either the REC mode or the PLAY mode.

You can turn histogram display on or off separately for the REC and PLAY modes.

2. Press [DISP].

3. On the “Info.” tab, select “+Histogram” and then press [SET].

NOTE

- You can use key customization to configure the [◀] and [▶] buttons so they control the EV shift setting. Then you can perform EV shift while viewing the results on the on-screen histogram (page 135).

■ How to Use the Histogram

A histogram is a graph that represents the lightness of an image in terms of the number of pixels. The vertical axis indicates the number of pixels, while the horizontal axis indicates lightness. You can use the histogram to determine whether an image includes the shadowing (left side), mid tones (center), and highlighting (right) to bring out sufficient image detail. If the histogram appears too lopsided for some reason, you can use EV shift to move it left or right in order to achieve better balance. Optimum exposure can be achieved by EV shifting so the graph is as close to the center as possible. The histogram also includes RGB histogram lines that show the distribution of R (red), G (green), and B (blue) components. These lines can be used to determine whether there is too much or too little of each of the color components in an image.

Example Histograms

When the histogram is to the left, it means that there are too many dark pixels. This type of histogram results when the overall image is dark. A histogram that is too far to the left may result in “black out” of the dark areas of an image, as shown in the nearby image.



When the histogram is to the right, it means that there are too many light pixels. This type of histogram results when the overall image is light. A histogram that is too far to the right may result in “white out” of the light areas of an image, as shown in the nearby image.



A centered histogram indicates that there is good distribution of light pixels and dark pixels. This type of histogram results when the overall image is at optimal lightness, as shown in the nearby image.



IMPORTANT!

- Note that the above histograms are shown for illustrative purposes only. You may not be able to achieve similar shapes for particular subjects.
- A centered histogram does not necessarily guarantee optimum exposure. If you intentionally want to over expose or under expose the image, you may not want a centered histogram.
- Due to the limitations of exposure compensation, you may not be able to achieve an optimum histogram configuration.
- Use of the flash and certain shooting conditions can cause the histogram to indicate exposure that is different from the actual exposure of the image when it was shot.
- The RGB (color component) histogram lines are displayed for snapshots only.

Other Useful Recording Functions

The following functions are also available in the REC mode to help make your digital image more efficient and enjoyable.

- Assign functions to the [◀] and [▶] keys
- Display an on-screen grid for easy image composition
- Review an image you just recorded
- Register initial power up settings
- Reset settings

Using Key Customize to Assign Functions [◀] and [▶]

Key Customize lets you assign any one of the five functions listed below to the [◀] and [▶] keys. Once you do, you will be able to use the assigned functions while shooting snapshots or movies, without going through the menus. For details about each of the functions, see the referenced page numbers.

When this function is assigned:	You can use [◀] and [▶] to do this:
Metering (page 127)	Change the metering setting
EV Shift (page 121)	Perform EV shifting for exposure compensation
White Balance (page 123)	Change the white balance setting
ISO (page 126)	Change the ISO sensitivity setting
Self-timer (page 81)	Select the self-timer time

1. In the REC mode, press [MENU].
2. On the “REC” tab, select “L/R Key”, and then press [▶].
3. Use [▲] and [▼] to select the function you want to assign and then press [SET].

After you assign a function, you can control its setting using the [◀] and [▶] keys.

Selecting “Off” leaves the [◀] and [▶] keys with no function assigned.

Displaying an On-screen Grid

The on-screen grid can be displayed on the REC mode monitor screen for easy alignment when composing images.



1. In the REC mode, press [MENU].
2. On the “REC” tab, select “Grid” and then press [▶].
3. Use [▲] and [▼] to select the setting you want and then press [SET].

To to this:	Select this setting:
Display the grid	On
Hide the grid	Off

Displaying the Image You Just Recorded (Image Review)

When you purchase your camera, it is initially configured with the Image Review feature turned on. Image Review displays the image you just recorded so you can check it.

1. In the REC mode, press [MENU].
2. On the “REC” tab, select “Review” and then press [▶].
3. Use [▲] and [▼] to select the setting you want and then press [SET].

To configure the camera to do this after an image is recorded:	Select this setting:
Display the image for about one second	On
Nothing	Off

Using Icon Help





Icon help displays guidance text about an icon when you select it on the monitor screen while in the REC mode (page 262).

- Icon help text is displayed for the following functions: Recording mode, focus mode, metering, flash mode, white balance, self-timer, EV shift. Note, however, that metering, white balance, self-timer and EV shift icon help text appears only when “Metering”, “White Balance”, “Self-timer” or “EV shift” respectively is assigned to the [◀] and [▶] keys with the key customization feature (page 135).

1. In the REC mode, press [MENU].
2. On the “REC” tab, select “Icon Help” and then press [▶].
3. Use [▲] and [▼] to select the setting you want and then press [SET].

To do this:	Select this setting:
Display icon help text next to the icon of a function when you select the function	On
Turn off icon help	Off

IMPORTANT!

- The icons listed below do not appear on the display while icon help is turned off.
 - Flash mode  icon (page 76)
 - Focus mode  icon (page 112)
 - White balance  icon (page 123)
 - Metering mode  icon (page 127)

Using Mode Memory to Configure Power On Default Settings

You can configure the camera so it saves certain settings in “mode memory” whenever it is turned off, and restores the settings the next time you turn the camera back on. This keeps you from having to configure the camera each time you turn it off and on.

See step 4 of the setting procedure below for information about the settings you can save with mode memory.

- 1. In the REC mode, press [MENU].**
- 2. On the “REC” tab, select “Memory” and then press [▶].**
- 3. Use [▲] and [▼] to select the item you want to configure and then press [▶].**

4. Use [▲] and [▼] to select the setting you want and then press [SET].

To do this:	Select this setting:
Save the current setting when the camera turned off, and restore it when the camera is turned back on	On
Restore the optimum default when the camera is turned on	Off

Setting	Mode Memory On	Mode Memory Off
BEST SHOT*1	Setting at power off	Exits BEST SHOT when camera is turned off.
Flash		Auto
Focus		Auto
White Balance		Auto
ISO		Auto
AF Area		Spot
Metering		Multi
Self-timer		Off
Flash Intensity		0
Digital Zoom		On
MF Position		Focus mode before manual focus was selected.
Zoom Position*2		Full wide

*1 “On” restores the selected BEST SHOT scene when the camera is turned back on. “Off” exits BEST SHOT when the camera is turned off.

*2 Optical zoom position only.

IMPORTANT!

- Turning the camera off while mode memory for the BEST SHOT mode is on will restore the settings of the BEST SHOT scene what was selected when you last turned off the camera. This is true, regardless of any of the mode memory on/off settings of each individual setting, except for Zoom Position.

Resetting the Camera to Its Initial Factory Defaults

Use the following procedure when you want to return to the camera to its initial factory default settings, which are the ones that are configured when you first purchase the camera. See “Menu Reference” on page 262 for the initial factory default setting for each menu item.

1. Press [MENU].
2. On the “Set Up” tab, select “Reset” and then press [▶].
3. Use [▲] and [▼] to select “Reset” and then press [SET].
 - To cancel the procedure without resetting, select “Cancel”.

 **IMPORTANT!**

- The following are not initialized when you reset the camera (page 264).
 - Home Time setup
 - World Time setup
 - Adjust
 - Date Style
 - Language
 - Video Out

VIEWING SNAPSHOTS AND MOVIES

Viewing a Snapshot

Use the following procedure to view snapshots on the camera's monitor screen.

1. Press [▶] to enter the PLAY mode.

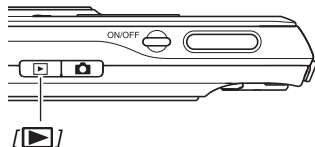

- This will display one of the snapshots in memory, along with some information about the settings used to shoot it (page 261).

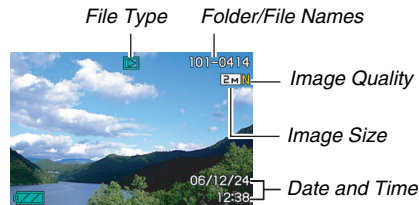

- The file type icon that appears at the top of the monitor screen depends on the type of file (snapshot, movie, audio only, etc) that is currently displayed.
 - [▶] : Snapshot (page 142)
 - [📹] : Movie (page 144)
 - [🔊] : Audio snapshot (page 143)
- See page 57 information about how to hide the image information and view the image alone.

2. Use [◀] and [▶] to scroll between images.

Press [▶] to scroll forward and [◀] to scroll back.



NOTE

- Holding down [◀] or [▶] scrolls at high speed.
- The image that initially appears when scrolling may appear to be a bit rough at first, but it will soon be replaced by an image with better definition. Note that if you copy an image from another type of digital camera, only a rough image may be shown on the monitor screen.

To switch to the REC mode

Press [📷].

Listening to the Audio of an Audio Snapshot

You can use the following procedure to play the audio of an audio snapshot. An audio snapshot is indicated by the “🔊” file type icon.

1. Enter the PLAY mode and then use [◀] and [▶] to display the audio snapshot whose audio you want to play.



2. Press [SET] to play the snapshot's audio from the camera's built-in speaker.

Audio Playback Controls

The following are the different operations you can perform while audio is playing.

To do this:	Do this:
Fast forward or fast reverse playback	Hold down [▶] or [◀].
Pause or restart playback	Press [SET].
Adjust volume	Press [▲] or [▼].
Change on-screen indicators	Press [DISP].
Stop playback	Press [MENU].

You can adjust volume while playback is in progress or paused only.

Viewing a Movie

Use the following procedure to view a movie on the camera's monitor screen.

1. Enter the PLAY mode and then use [◀] and [▶] to display the movie you want to play.

- Check the file type icon. The file type icon of a movie is “” (Movie) icon (page 261).

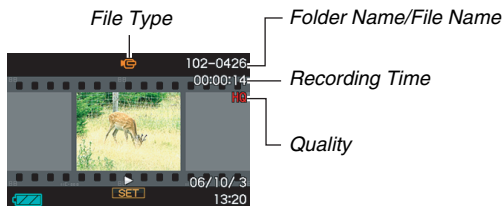

The film-like frame that appears on the monitor screen indicates that this is an image from a movie.

2. Press [SET] to start playback.

- The monitor screen will return to the selection screen in step 1 after the end of the movie is reached.

To switch to the REC mode

Press [].

Movie Playback Controls

To do this:	Do this:
Fast forward or fast reverse playback. <ul style="list-style-type: none">Each press of either button increases the speed of the fast forward or fast reverse operation up to three steps.	Hold down [▶] or [◀].
Return from fast forward/fast reverse to normal playback	Press [SET].
Pause or restart playback	Press [SET].
When paused, scroll forward or back frame-by-frame <ul style="list-style-type: none">Hold down either button to scroll non-stop.	Press [▶] or [◀].
Adjust volume <ul style="list-style-type: none">Volume can be adjusted only while movie playback is in progress.	Press [▲] or [▼].
Toggle on-screen indicators on or off	Press [DISP].

To do this:	Do this:
Zoom in up to 4.5X <ul style="list-style-type: none">While an image is zoomed, you can use [▲] [▼] [◀] and [▶] to move around and view the parts of the image that do not fit on the monitor screen.	Press the zoom button ().
Stop playback	Press [MENU].



IMPORTANT!

- Playback may not be possible for movies not recorded with this camera.

Playing Back a Movie with Anti Shake

Use the following procedure when you want to play back a movie with Anti Shake. Anti Shake is particularly useful when you have the camera connected to a TV for viewing, since the effects of camera movement are more evident on a big screen.

- 1. In the PLAY mode, use [◀] and [▶] to display the movie you want to play with Anti Shake.**
- 2. Press [●] to turn on Anti Shake.**
 - Each press of [●] toggles Anti Shake on and off.
 - “” (Anti Shake indicator) is displayed on the monitor screen while Anti Shake is turned on.
- 3. After the setting is the way you want, press [SET].**

NOTE

- You can press [●] to turn Anti Shake on and off while the movie is stopped or playing.
- You can also use the following procedure to turn Anti Shake on and off.
 1. While a movie is playing, press [MENU].
 2. Select the “PLAY” tab, select “ Anti Shake”, and then press [▶].
 3. Use [▲] and [▼] to select “On”, and then press [SET].
- When Anti Shake is turned on, the area of the monitor screen used for playback is slightly smaller than normal.



Playing a Slideshow on the Camera

The slideshow feature lets you play the files stored in memory in sequence, automatically.

You can configure the slideshow so it plays the files the way you want.

1. In the **PLAY** mode, press [MENU].
2. On the “PLAY” tab, select “Slideshow” and then press [▶].
3. Configure the slideshow settings.

Use [▲] and [▼] to select an item and then configure it as described below.

Images (Select the files you want to include in the slideshow.)	<ul style="list-style-type: none">• All images: Includes all snapshots, movies, and audio in memory.•  Only: Includes snapshots and audio snapshots only.•  Only: Includes movies only.• One Image: Includes only one specific image (selected using [◀] and [▶]).• Favorites: Includes snapshots in the FAVORITE folder (page 181).
Time (Specify the time of the slideshow, from start to finish.)	Use [◀] and [▶] to select one of the following times (in minutes): 1, 2, 3, 4, 5, 10, 15, 30, 60.
Interval (Select the interval between slides.)	Use [◀] and [▶] to select a value from 1 to 30 seconds, or “MAX”. <ul style="list-style-type: none">– If you specify a value from 1 to 30 seconds, images change at the specified interval, but the audio portion of movies and audio snapshots will continue to play until the end, regardless of the interval setting.– When “MAX” is selected, only the first frame of each movie is displayed, without any playback of the audio.

Effect (Select a special effect.)	<p>Use [▲] and [▼] to select the effect you want.</p> <ul style="list-style-type: none">• Pattern 1, 2, 3, 4: Applies preset effects in sequence.• Random: Applies preset effects (Pattern 1, 2, 3, 4) in random sequence.• Off: No effect applied.<ul style="list-style-type: none">– The “Effect” setting is disabled when “Favorites” is selected for “Images”, or when the “Interval” setting is “MAX”, “1” or “2”.
--	---

4. Use [▲] and [▼] to select “Start” and then press [SET] to start the slideshow.

The slideshow is performed in accordance with the settings you configured above.

- You can also scroll through images during a slide show by pressing [▶] (forward) and [◀] (back).
- To adjust the level of audio volume during a slideshow, use [▲] and [▼] to adjust the volume.

To stop a slideshow

Press [SET]. This will return to the PLAY mode.

- Pressing [MENU] instead of [SET] stops the slideshow and returns to the menu screen.
- Pressing [📷] instead of [SET] stops the slideshow and switches to the REC mode.

IMPORTANT!

- All button operations are disabled while the slideshow is switching from one image to another. Wait until an image is stopped on the display before performing a button operation. If a button does not work, wait a bit and try again.

NOTE

- Selecting a movie when “One Image” is selected for “Images” and then selecting a movie for the slideshow will cause the movie to play back repeatedly within the time specified by the slideshow “Time” setting.
- In image copied from a computer or an image recorded with a different type of digital camera may remain on the screen longer than the time specified by “Interval”.

■ **Playing a Slideshow on the USB Cradle (Photo Stand)**

You can play a slideshow on the camera while it is mounted on the USB cradle. This is a good way to enjoy a long slideshow, without worrying about the camera’s battery going dead.

- Configure slideshow settings (page 147) before performing the steps below.
- Connect the bundled AC adaptor to the USB cradle, and plug it into a power outlet.

1. Turn on the camera and place it onto the USB cradle.

2. Press the USB cradle's [PHOTO] button to start the slideshow.

The slideshow is performed in accordance with the settings you configured with the procedure on page 147. The camera will turn off automatically after the time you specified with the "Time" setting elapses.

- You can change the slideshow setting by pressing [MENU] while a slideshow is in progress. After configuring the settings, press [MENU] again to restart the slideshow.
- To adjust the level of audio volume during a slideshow, use [▲] and [▼] to adjust the volume.

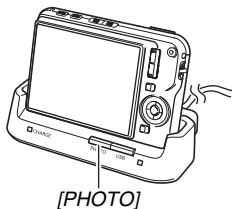

To stop a slideshow

Press the USB cradle's [PHOTO] button. This will turn off the camera.

IMPORTANT!

- The battery does not charge while a slideshow is in progress. To charge the battery, stop the slideshow.
- Do not remove the camera from the cradle while a slideshow is in progress. Doing so can cause data to become corrupted.

NOTE

- You can connect the USB cradle to a TV and enjoy the slideshow on a big screen. You can also connect to a video recording device and record a slideshow (page 151).

Viewing Camera Images on a TV

Use the procedure below to view snapshots and movies on a TV screen.

- You need to use the USB cradle and the AV cable that comes with the camera to connect to a TV.

1. Connect the USB cradle to a TV.

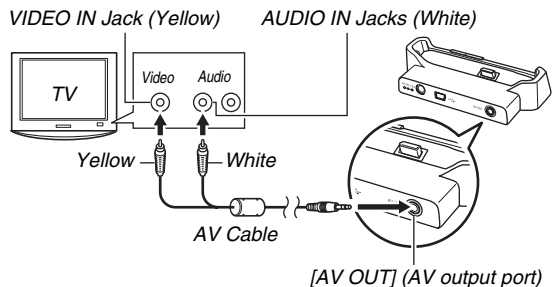

2. Turn off the camera and place it onto the USB cradle.

3. Turn on the TV and select its video input mode.

If the TV has more than one video input, select the one where the USB cradle is connected.

4. Press [▶] to turn on the camera and enter the PLAY mode.

Pressing [ON/OFF] or [📷] will not turn on the camera.

When the camera turns on in the PLAY mode, an image will appear on the TV screen. The camera's monitor screen will not turn on.

5. Now you can perform the applicable operation on the camera for the type of file you want to play.

- At this point you could press the USB cradle's [PHOTO] button to start a slideshow (page 150).

To turn off the camera

You can turn off the camera by doing either of the following.

- Press the camera's [ON/OFF] button.
- Press the USB cradle's [USB] button.



IMPORTANT!

- When connecting to a TV to display images, be sure to configure the camera's [RECORD] (REC) and [PLAY] (PLAY) buttons for "Power On" or "Power On/Off" (page 197).
- All icons and indicators that appear on the monitor screen also appear on the TV screen.
You can use [DISP] to change the display contents.
- Audio is monaural.
- Certain TVs may cut off part of the images.
- Audio is initially output by the camera at maximum volume. When you first start displaying images, set the TV volume control at a relatively low level and then adjust it as required.

NOTE

- After using an optionally available AV cable (EMC-3A) to connect the camera's cradle connector directly to the VIDEO IN terminal of a TV (without using the USB cable), you can view recorded images on the TV.

- You can use the camera's USB cradle to connect to a DVD recorder or video deck and record images from the camera. There are various different methods you can use in order to connect to another device when recording images. The following describes one method for connection using the AV cable that comes with the camera.

- DVD recorder or video deck: Connect to the VIDEO IN and AUDIO IN terminals.
- USB cradle: Connect to the [AV OUT] (AV output port)
- Camera: Place onto the cradle

You can play a slideshow of snapshots and movies on the camera and record it on a DVD or video tape. You can record movies by selecting "Still Only" for the slideshow "Images" setting (page 147). When recording to DVD recorder or video deck, you can turn off display information (page 57) so indicators and other information is not recorded along with the image.

To view the image that is being recorded, connect a TV or other monitor to the DVD recorder or video deck that is connected to the camera. For information about connecting a monitor to the DVD recorder or video deck and about how to record, see the user documentation that comes with the DVD recorder or video deck you are using.

■ Selecting the Screen Aspect Ratio and Video Output System

You can use the procedure in this section to select either NTSC or PAL as the video output system. You can also specify an aspect ratio of 4:3 or 16:9.

For this type of TV:	Select this video output system:
Standard aspect ratio screen NTSC TV (Japan, U.S., and other countries)	NTSC 4:3
Wide aspect ratio screen NTSC TV (Japan, U.S., and other countries)	NTSC 16:9
Standard aspect ratio screen PAL TV (Europe and other areas)	PAL 4:3
Wide aspect ratio screen PAL TV (Europe and other areas)	PAL 16:9

1. Press [MENU].
2. On the “Set Up” tab, select “Video Out” and then press [▶].
3. Use [▲] and [▼] to select the setting you want and then press [SET].

IMPORTANT!

- Select the aspect ratio (4:3 or 16:9) that matches the type of TV you plan to use. You may also need to configure the aspect ratio setting on your TV as well. Incorrect aspect ratio settings on the camera and/or the TV can result in abnormal image display.
- Images will not display correctly unless the camera’s video signal output setting matches the video signal system of the TV or other video equipment.
- Images will not display correctly on a TV or video equipment that is not NTSC or PAL.

Zooming the Displayed Image

Perform the following procedure to zoom the image currently on the monitor screen up to eight times its normal size.

1. In the PLAY mode, and use [◀] and [▶] to display the snapshot you want to zoom.

2. Press the zoom button (🔍).

Each press of this button zooms the image more. You can use [▲], [▼], [◀], and [▶] to move to a different part of the image after zooming.

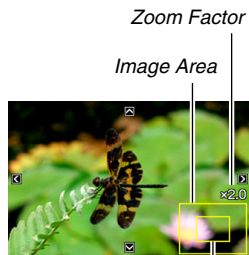

Part of the image that is currently displayed.

To zoom back out, press the zoom button (🔍).

- If display indicators are turned on, an indicator in the lower right corner of the monitor screen shows what part of the zoomed image is currently displayed.

To return to image to normal size

Press [MENU] or [BS].



IMPORTANT!

- Depending on the image size, some images may not be able to be zoomed to the full 8 times normal size.

Using the 12-image Screen

You can use the procedure below to display a screen that shows 12 images.

1. Press the zoom button ().

This displays the 12-image screen with a selection boundary around the last image that was on the monitor screen.

Selection Boundary



2. Select the image you want.

- Use [◀] and [▶] to scroll between 12-image screens.
- To view the full-screen version of a particular image, use [▲], [▼], [◀], and [▶] to move the selection boundary to it and then press [SET].

Using the Calendar Screen

Use the following procedure to display a calendar, which shows the first image recorded on each date of a particular month. This screen helps to make searching for an image quicker and easier.

1. In the PLAY mode, press the zoom button () twice.

This displays the calendar screen.

- You can also display the calendar by pressing [MENU], selecting the “PLAY” tab, selecting “Calendar”, and then pressing [▶] to display the calendar.
- To exit the calendar screen, press [MENU] or [BS].



Year/Month

Selection Boundary

2. Use [▲], [▼], [◀], and [▶] to move the selection boundary to the date whose image you want to view and then press [SET].

This will display the first image recorded on that date.

NOTE

- The year and month on the calendar is displayed using the same format as you selected for the “Date Style” setting (page 194).

IMPORTANT!

- Note following points about how certain editing functions of the camera affect the date with which the image is associated on the calendar screen.

Performing this type of editing operation:	Will associate the resulting image with this date:
Keystone, Color Correction, Resize, Trimming, Copy	The date that the editing operation was performed
Editing the date and time of an image	The date that the original image was recorded

Using Image Roulette

Image Roulette scrolls through images on the monitor screen, finally stopping randomly at a final image. It puts some fun into image viewing that you can use for game playing, to award prizes, for fortunetelling, and just about anything else you can imagine.

1. While the camera is turned off, hold down [◀] and [▶].

- Keep the buttons depressed until an image appears on the display.

2. Release the buttons when Image Roulette starts.

- The screen will scroll through images and finally stop at one of them.

To perform another Image Roulette operation

Press [] or [].



To stop Image Roulette

Press [] to enter the REC mode or press [ON/OFF] to turn off the camera.

- The camera will exit Image Roulette automatically you do not perform the next Image Roulette operation within about one minute after the final image of the previous operation appeared on the monitor screen.



IMPORTANT!

- Image Roulette does not play audio or movie files.
- For a rotated snapshot (page 165), the Image Roulette screen shows the unrotated version of the image.
- Note that Image Roulette works only with images shot with this camera. Image Roulette may not operate properly when other types of images are in memory.
- You can use Image Roulette only when “[]” and “[]” are configured for “Power On” or “Power On/Off” (page 197).

EDITING IMAGES

Resizing a Snapshot

You can change the size of a snapshot and save the result as a separate snapshot. The original snapshot is also retained. You can resize a snapshot to any one of the following sizes.

Image Size (Pixels)		Print Size	
Larger ↑	5M*	2560 × 1920	A3 Print
	3M	2048 × 1536	A4 Print
↓ Smaller	VGA	640 × 480	E-Mail • Optimum size for an image to be attached to e-mail.

* M stands for “Mega”, which means “million”.

- 1. In the PLAY mode, press [MENU].**
- 2. On the “PLAY” tab, select “Resize” and then press [▶].**
- 3. Use [◀] and [▶] to scroll through images and display the one you want to resize.**

- 4. Use [▲] and [▼] to select an image size, and then press [SET].**

- When you select an image size, it will start to cycle through the following information:

Image Size → Number of Pixels → Print Size → .

The print size indicates the optimum paper size for printing a snapshot of the selected image size.

- 5. After you press [SET] in step 4 to resize the image, the monitor screen returns to step 3. From there you can repeat steps 3 and 4 to resize another image if you want.**

To exit the resize operation, select “Cancel”.

IMPORTANT!

- Note that you cannot resize the following types of snapshots.
 - VGA (640 × 480 pixels) and smaller snapshots
 - Images created using MOTION PRINT
 - Images recorded with another camera
- Resizing a snapshot shot with an aspect ratio of 16:9 or 3:2 will cause the left and right sides of the image to be cut off. The aspect ratio of the resulting image will be 4:3.
- Resizing cannot be performed if there is not enough memory to store the resized version of the snapshot.
- The recording date of the resized version of the snapshot will be the same as the recording date of the original snapshot.

Cropping a Snapshot

You can crop a snapshot to trim parts you do not need, and save the result in a separate file. The original snapshot is also retained.

- 1. In the PLAY mode, use [◀] and [▶] to scroll through images and display the snapshot you want to crop.**
- 2. Press [MENU].**
- 3. On the “PLAY” tab, select “Trimming” and then press [▶].**

- This operation can be performed only while a snapshot is on the monitor screen.

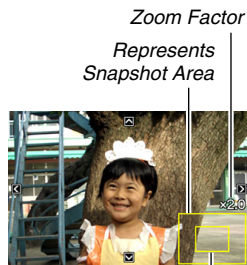

Part of image that is currently displayed.

4. Use the zoom button to zoom, and [▲], [▼], [◀], and [▶] to move around the zoomed image to display the part you want to extract.

5. Press [SET] to extract the displayed part and save it as a separate file.

- To exit the cropping procedure at any time before you press [SET], press [MENU].



IMPORTANT!

- Note that you cannot crop the following types of images.
 - Images created using MOTION PRINT
 - Images recorded with another camera
- The image produced by cropping a 3:2 or 16:9 image will have an aspect ratio of 4:3.
- Cropping cannot be performed if there is not enough memory to store the extracted image.
- The recording date of the extracted image will be the same as the recording date of the original snapshot.

Keystone Correction

Use the following procedure to correct the snapshot of a blackboard, document, poster, photograph, or other rectangular object that is out of square because it was recorded at an angle. Performing keystone correction on an image causes a new (corrected) 2M (1600 × 1200 pixels) size image to be stored as a separate file.

1. In the **PLAY** mode, use [◀] and [▶] to scroll through images and display the snapshot you want to correct.

2. Press [MENU].

3. On the “**PLAY**” tab, select “**Keystone**” and then press [▶].

This displays screen that shows all of the rectangular shapes in the image that qualify as candidates for keystone correction.

- Note that the above step is possible only when there is a snapshot displayed on the monitor screen.

4. Use [◀] and [▶] to select the candidate you want to correct.

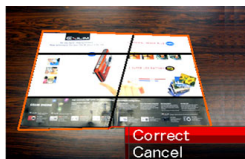

5. Use [▲] and [▼] to select “Correct” and then press [SET].

- Select “Cancel” to exit the procedure without performing keystone correction.

★ **IMPORTANT!**

- If the original image is smaller than 2M (1600 × 1200 pixels) size, the new (corrected) version will be the same size as the original one.
- Keystone correction cannot be performed on the following types of images.
 - Movie images
 - Images created with MOTION PRINT
 - Images recorded with another camera
- The keystone correction operation cannot be performed if there is not enough memory to store the corrected image.
- When you display a corrected image on the camera’s monitor screen, the date and time indicate when the image was originally recorded, not when the image was corrected.
- When a keystone corrected image appears on the full-month calendar screen, it is displayed on the date that it was corrected (page 155).

Using Color Restoration to Correct the Color of an Old Photograph

Color restoration let you correct the old color of a photograph shot with a digital camera. This function is useful for correcting existing old photographs, posters, etc.

- Performing color restoration on an image causes a new (restored) 2M (1600 × 1200 pixels) size image to be stored as a separate file.

1. In the PLAY mode, use [◀] and [▶] to scroll through images and display the snapshot you want to correct.

2. Press [MENU].

3. On the “PLAY” tab, select “Color Correction” and then press [▶].

4. Use [◀] and [▶] to select the photograph candidate you want.

5. Use [▲] and [▼] to select “Trim”, and then press [SET].

This displays a cropping boundary on the monitor screen.

- To exit color restoration without storing anything, select “Cancel”.

6. Press the zoom button to zoom the cropping boundary.

- The size of the area you can select with the cropping boundary will depend on the size of the currently displayed image.

7. Use [▲], [▼], [◀], and [▶] to move the cropping boundary to the location you want and then press [SET].

The camera will correct color automatically and save the corrected image.

- If you do not want a border around the image, configure the cropping boundary so it is slightly inside of the boundary of the displayed image.
- To exit color restoration without saving anything, press [MENU].

IMPORTANT!

- If the original image is smaller than 2M (1600 × 1200 pixels) size, the new (restored) version will be the same size as the original one.
- Note that you cannot correct the following types of images.
 - Movie images and the voice recording file icon
 - Images created with MOTION PRINT
 - Images recorded with another camera
- The color correct operation cannot be performed if there is not enough memory to store the corrected image.
- When you display a restored image on the camera's monitor screen, the date and time indicate when the image was originally recorded, not when the image was corrected.
- When a corrected image appears on the full-month calendar screen, it is displayed on the date that it was corrected (page 155).

NOTE

- If you want to record the image of an old photograph with this camera and restore the resulting image, see "Restoring an Old Photograph" on page 109.

Editing the Date and Time of an Image

Use the procedure in this section to change the date and time of a previously recorded image. This capability comes in handy when the current date and time are wrong due to the following reasons.

- Because the camera's clock settings were not configured correctly when the image was recorded (page 12)
- Because the image was recorded using the wrong World Time zone (page 194)

1. In the PLAY mode, use [◀] and [▶] to display the image whose date and time you want to edit.

2. Press [MENU].

3. On the "PLAY" tab, select "Date/Time" and then press [▶].

4. Set the date and the time you want.

To do this:	Do this:
Change the value at the cursor location	Press [▲] or [▼].
Move the cursor between settings	Press [◀] or [▶].
Toggle between 12-hour and 24-hour timekeeping	Press [BS].

5. When all the settings are the way you want, press [SET] to apply them.

- After editing the time and date, display the image to confirm that the date and time are correct.

IMPORTANT!

- You cannot change the date of the following types of files.
 - Movies, Voice recordings
 - Images created with MOTION PRINT
- The date and time stamped into an image using the Time Stamp feature cannot be edited (page 131).
- You cannot edit the date and time of a image that is protected. Unprotect the image and then edit the date and time.
- You can specify any date in the range of January 1, 1980 to December 31, 2049.

Rotating an Image

Perform the following procedure to rotate the image (snapshot or movie) currently on the monitor screen. This feature comes in handy with a snapshot that you shot using portrait (vertical) orientation. After rotating a snapshot, you can return it to its original orientation, if you want.

- Note that this procedure does not actually change the image data. It simply alters how the snapshot is displayed on the camera's monitor screen.



- 1. In the PLAY mode, press [MENU].**
- 2. On the “PLAY” tab, select “Rotation” and then press [▶].**
 - This operation can be performed only while a snapshot or movie image is on the monitor screen.
- 3. Use [◀] and [▶] to select the snapshot whose display image you want to rotate.**
- 4. Use [▲] and [▼] to select “Rotate” and then press [SET].**
 - Each press of [SET] will rotate the displayed image 90 degrees left.
- 5. When the displayed image is at the orientation you want, press [MENU].**

IMPORTANT!

- You cannot rotate an image that is protected. To rotate a protected snapshot, first remove its protection (page 180).
- You may not be able to rotate an image recorded with another camera.
- The following images cannot be rotated.
 - The voice recording file icon
 - Images created with MOTION PRINT
 - Zoomed images
- The original (unrotated) version of a snapshot's image will be displayed on the 12-image screen and the calendar screen.
- Movies can be rotated on the camera's monitor screen only. The movie is not rotated when played on a computer screen.

Editing a Movie on the Camera

You can perform the following cut operations on the camera to edit movies you have recorded.

Operation	Description
 Cut (To-Point Cut)	Cuts everything from the current location to the beginning of the movie.
 Cut (Point-To-Point Cut)	Cuts everything between two points.
 Cut (From-Point Cut)	Cuts everything from the current location to the end of the movie.

★ **IMPORTANT!**

- When you edit a movie, only the result is saved. The original movie is not retained. Once you perform an editing operation, you will not be able to undo it.
- A movie that is shorter than five seconds cannot be edited.
- The movie editing operation is supported only for movies that were recorded with this camera.
- You will not be able to edit a movie if the amount of remaining memory capacity is less than the size of the movie file you want to edit. If there is not enough memory available, delete any files you no longer need to free up more.
- Cutting a movie into two parts or splicing of two movies into a single movie cannot be performed on the camera.

■ **Editing with To-Point Cut or From-Point Cut**

1. Play back the movie you want to edit.

2. Press [SET] to pause playback.

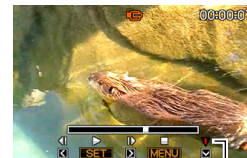

- Check to make sure that “▼” (cut icon) is displayed on the monitor screen. If it isn't, press [SET] again.



Cut icon

3. Press [▼].

- You could also perform the following steps in place of steps 1 through 3 above.
 - ① In the PLAY mode, select the movie you want to edit and then press [MENU].
 - ② On the “PLAY” tab, select “Movie Editing” and then press [▶].

4. Use [▲] and [▼] to select “ Cut” (To-Point Cut) or “ Cut” (From-Point Cut) and then press [SET].

- To cancel movie editing, select “Cancel” and then press [SET]. This will return to the paused movie playback screen.

5. Use the following operations to select the frame (point) from which or to which you want to cut the movie (the cut point).

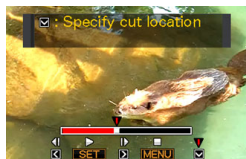

To do this:	Press this button:
Fast forward or fast reverse playback	[▶] or [◀]
Pause or unpause movie playback	[SET]
Scroll paused playback one frame forward or back	[▶] or [◀]

- The part of the movie indicated in red on the displayed indicator bar is the part that will be cut.
- To cancel the cut operation, press [MENU]. This will return to the screen in step 3.

6. When the frame where you want the cut point to be is displayed, press [▼].

7. In response to the confirmation message that appears, use [▲] and [▼] to select “Yes” and then press [SET].

- To cancel movie editing, select “No” instead of “Yes” and then press [SET]. This will return to the paused movie playback screen.
- The selected cut operation will take considerable time to complete. Wait until the “Busy... Please wait...” message disappears from the monitor screen before performing any operation on the camera. Note that a cut operation can take a very long time if the movie being edited is long.

■ **Using Point-To-Point Cut**

1. Play back the movie you want to edit.

2. Press [SET] to pause playback.



Cut icon

3. Press [▼].

- You could also perform the following steps in place of steps 1 through 3 above.
 - ① In the PLAY mode, select the movie you want to edit and then press [MENU].
 - ② On the “PLAY” tab select “Movie Editing” and then press [▶].

4. Use [▲] and [▼] to select “Cut” (Point-To-Point Cut) and then press [SET].

- To cancel movie editing, select “Cancel” and then press [SET]. This will return to the paused movie playback screen.

5. Use the following operations to select the frames (points) between which you want to cut the movie (the cut points).

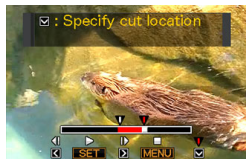

To do this:	Press this button:
Fast forward or fast reverse playback	[▶] or [◀]
Pause or unpause movie playback	[SET]
Scroll paused playback one frame forward or back	[▶] or [◀]

- To cancel the cut editing operation, press [MENU]. This will return to the screen in step 3.

6. When the frame where you want the first (From) cut point to be is displayed, press [▼].

7. Repeat step 5 to select the frame you want to use as the second (To) cut point.

- The part of the movie indicated in red on the displayed indicator bar is the part that will be cut.

- 8. When the frame where you want the second (To) cut point to be is displayed, press [▼].**
- 9. In response to the confirmation message that appears, use [▲] and [▼] to select “Yes” and then press [SET].**
- To cancel movie editing, select “No” instead of “Yes” and then press [SET]. This will return to the paused movie playback screen.
 - The selected cut operation will take considerable time to complete. Wait until the “Busy... Please wait...” message disappears from the monitor screen before performing any operation on the camera. Note that a cut operation can take a very long time if the movie being edited is long.

Creating a Snapshot of a Movie Frame (MOTION PRINT)

MOTION PRINT lets you capture a movie frame and use it to create a snapshot. The snapshot you create can be either of the two formats described below.

9-frame Snapshot (2M 1600 × 1200 pixels)

This format puts the selected movie frame in the center, the four frames that precede it along top and the four frames that follow it along the bottom.



**1-frame Snapshot
(VGA 640 × 480
pixels)**

This format creates a snapshot using the selected movie frame only.

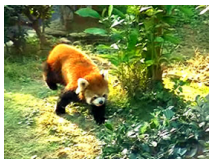

- 1. In the PLAY mode, use [◀] and [▶] to scroll through images and display the movie that contains the frame you want to use.**
- 2. Press [MENU].**
- 3. On the “PLAY” tab, select “MOTION PRINT”, and then press [▶].**
- 4. Use [▲] and [▼] to select either “9 frames” or “1 frame”.**

5. Use [◀] and [▶] to scroll through the movie frames and search for the one you want to use as the image of the snapshot.

- Holding down [◀] or [▶] scrolls at high speed.

6. After displaying the movie frame you want, press [SET].

- If you selected “9 frames” in step 4, the camera will create a 9-frame snapshot with the frame you selected in step 6 in the center.
- If you selected “1 frame” in step 4, the camera will create a snapshot of the frame you selected in step 6.



IMPORTANT!

- MOTION PRINT is not possible using a movie that was recorded on a different type of camera.

USING AUDIO

Adding Audio to a Snapshot

The dubbing feature of your camera lets you add audio to a snapshot after you shoot it. A snapshot that includes audio (regardless of whether the audio was recorded on the spot or added later) is indicated by the “” icon.

You can re-record a snapshot’s audio whenever you want. You can record up to about 30 seconds of audio for a snapshot.

■ Adding Audio to a Snapshot

1. In the **PLAY** mode, use [**◀**] and [**▶**] to scroll through images and display the snapshot to which you want to add audio.
2. Press [**MENU**].

3. On the “**PLAY**” tab, select “**Dubbing**” and then press [**▶**].

- This operation can be performed only while a snapshot is on the monitor screen.



4. Press the shutter button to start audio recording.

5. Press the shutter button again to stop audio recording.

Recording will stop automatically after about 30 seconds if you do not press the shutter button.

To play back snapshot audio

Perform the steps under “Listening to the Audio of an Audio Snapshot” on page 143.

■ Re-recording Snapshot Audio

IMPORTANT!

- Note that you cannot restore the original audio once you delete or re-record the audio of a snapshot.
- 1. In the PLAY mode, use [◀] and [▶] to scroll through images and display the snapshot whose audio you want to re-record.**
 - 2. Press [MENU].**
 - 3. On the “PLAY” tab, select “Dubbing” and then press [▶].**
 - 4. Use [▲] and [▼] to select “Delete” and then press [SET].**
 - If you just want to delete the audio of the snapshot without re-recording anything, press [MENU] here and skip the rest of this procedure.

5. Press the shutter button to start audio recording.

This deletes the previous recording and replaces it with the new one.

6. Press the shutter button again to stop audio recording.

Recording will stop automatically after about 30 seconds if you do not press the shutter button.

IMPORTANT!

- Take care that you do not block the camera's microphone with your fingers while recording.
- Good recording results are not possible when the camera is too far away from what you are trying to record.
- You may not be able to record audio if remaining memory capacity is too low.
- Adding audio (dubbing) is not possible for the following types of images.
 - Movies
 - Snapshots created using MOTION PRINT
 - Protected snapshots

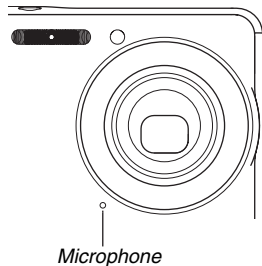

NOTE

- Your camera supports the following audio data formats.
 - Audio Format: WAVE/ADPCM (.WAV extension)
 - Approximate Audio File Size: 165KB (30-second recording at 5.5KB per second)

Recording Audio Only (Voice Recording)

Voice Recording lets you record audio only, without a snapshot or movie.

Using built-in memory only, you get up to about 18 minutes of Voice Recording.

1. In the REC mode, press [BS].
2. Use [▲], [▼], [◀], and [▶] to select “Voice Recording” and then press [SET].

This causes “” to appear on the monitor screen.

3. Press the shutter button to start recording.

- The operation lamp flashes green while recording is in progress.
- You can press [DISP] during recording to turn off the monitor screen.
- Pressing [SET] during recording will insert a marker into the recording. During later playback, you will be able to jump to the markers in the recording.

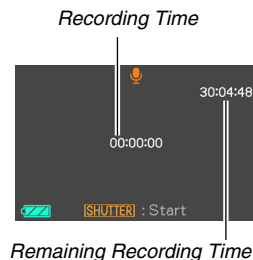

4. Press the shutter button again to stop audio recording and return to the screen in step 3.

- Recording also will stop automatically if memory becomes full.
- If you press [ON/OFF] (Power) or play [▶] (PLAY), or if the battery goes dead during recording will stop the recording operation and save anything you have recorded up to that point.

5. Now you can repeat steps 3 and 4 to record more, or you can exit this procedure by pressing [BS] and selecting another BEST SHOT scene.

When exiting this procedure, select “Auto” for normal image recording.

IMPORTANT!

- Take care that you do not block the camera's microphone with your fingers while recording.
- Good recording results are not possible when the camera is too far away from what you are trying to record.

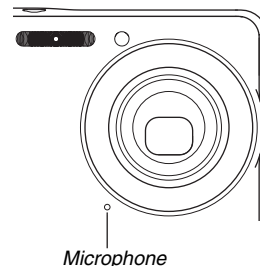

NOTE

- You can also play back Voice Recording data on your computer using Windows Media Player or QuickTime.
- Your camera supports the following audio data formats.
 - Audio Data: WAVE/ADPCM (.WAV extension)
 - Approximate Audio File Size: 165 KB (30-second recording at 5.5KB per second)

■ Playing Back Voice Recording Data

1. Enter the PLAY mode, and then use [◀] and [▶] to display the Voice Recording file you want to play.

“” is displayed in place of an image for a Voice Recording file.

2. Press [SET] to start playback.



Voice Recording Playback Controls

The following are the different operations you can perform while a Voice Recording is playing.

To do this:	Do this:
Fast forward or fast reverse playback.	Hold down [▶] or [◀].
Pause or restart playback	Press [SET].
Jump to a marker in the audio data while playback is paused.	Press [▶] or [◀].
Adjust volume <ul style="list-style-type: none">You can adjust volume only while playback is in progress or paused.	Press [▲] or [▼].
Toggle on-screen indicators on or off	Press [DISP].
Stop playback	Press [MENU].

MANAGING YOUR FILES

Files and Folders

Your camera treats each snapshot, movie, and Voice Recording, as a separate file.

You can delete, protect, and copy files as required.

Files are grouped in folders that are created automatically by the camera.

Files and folders have their own unique names, which are assigned automatically by the camera.

- For details about how folders are organized in memory, see "Memory Folder Structure" (page 246).

	Name and Maximum Number Allowed	Example
File	Each folder can contain up to 9999 files named CIMG0001 through CIMG9999. The extension on the file name depends on the file type. <ul style="list-style-type: none">• If a folder already contains 9999 files, recording another file will cause a new folder to be created automatically.	26th file name: CIMG <u>0026</u> . <u>JPG</u> <i>Serial number Extension</i> <i>(4 digits)</i>
Folders	Folders are named from 100CASIO to 999CASIO <ul style="list-style-type: none">• There can be up to 900 folders.	100th folder name: <u>100</u> CASIO <i>Serial number (3 digits)</i>

NOTE

- You can view folder and file names on your computer. For details about how file names are displayed on the camera's monitor screen, see page 260.
- The total number of folders and files that is allowed depends on the image size and quality, and capacity of the memory card being used for storage.

Protecting a File Against Deletion

You can protect an important file to ensure that it cannot be deleted accidentally.

IMPORTANT!

- Note that even if a file is protected, it will be deleted if you perform the format operation (pages 15, 50, 199).

■ Protecting a Specific File

1. In the PLAY mode, press [MENU].
2. On the “PLAY” tab, select “Protect” and then press [▶].
3. Use [◀] and [▶] to scroll through images until the one you want to protect is on the monitor screen.

4. Use [▲] and [▼] to select “On” and then press [SET].

An image that is protected is indicated by the “” icon.



5. Now you can repeat steps 3 and 4 to protect another image or exit this procedure by pressing [MENU].

To unprotect a specific file

Perform the procedure under “Protecting a Specific File”, but in step 4 select “Off” instead of “On”.

■ Protecting All Files in Memory

1. In the **PLAY** mode, press [MENU].
2. On the “**PLAY**” tab, select “**Protect**” and then press [▶].
3. Use [▲] and [▼] to select “**All Files : On**” and then press [SET].
This protects all files currently in memory.
4. Press [MENU].

To unprotect all files in memory

Perform the procedure under “Protecting All Files in Memory”, but in step 3 select “All Files : Off” instead of “All Files : On”.

Using the FAVORITE Folder

The FAVORITE folder is located in the camera’s built-in memory, and you can use it to store personal snapshots that you do not want displayed during normal PLAY mode operations. FAVORITE folder snapshots remain in camera memory, even if you change to a different memory card.



IMPORTANT!

- The FAVORITE folder can be used for snapshots only. Saving an audio snapshot in the FAVORITE folder will save the snapshot part only.

■ Copying a File to the FAVORITE Folder

1. In the **PLAY** mode, press [MENU].
2. On the “**PLAY**” tab, select “**Favorites**” and then press [▶].
3. Use [▲] and [▼] to select “**Save**” and then press [SET].
4. Use [◀] and [▶] to select the snapshot you want to copy to the **FAVORITE** folder.
5. Use [▲] and [▼] to select “**Save**”, and then press [SET].
This saves a copy of the snapshot to the **FAVORITE** folder.
6. Now you can repeat steps 4 and 5 to save another image, or press [MENU] twice to exit this procedure.

IMPORTANT!

- The snapshot copied to the **FAVORITE** folder is converted to QVGA size (320 × 240 pixels). A snapshot in the **FAVORITE** folder cannot be restored to its original size.
- Snapshots in the **FAVORITE** folder cannot be copied to a memory card.

NOTE

- The number of snapshots that can be stored in the **FAVORITE** folder depends on the image quality of each one, and how much built-in memory capacity is remaining.

■ Viewing Snapshots in the FAVORITE Folder

1. In the PLAY mode, press [MENU].
2. On the “PLAY” tab, select “Favorites” and then press [▶].
3. Use [▲] and [▼] to select “Show” and then press [SET].
4. Use [◀] and [▶] to scroll through the snapshots in the FAVORITE folder.

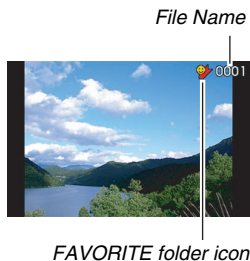

5. After you are finished viewing the FAVORITE folder snapshots, press [MENU] twice to exit this procedure.

Perform the following steps to view FAVORITE folder contents on your computer.

1. Remove the memory card from the camera.
2. Place the camera on the USB cradle (which is connected to the computer).
3. Perform the required operations on your computer to navigate to the camera's memory and display the FAVORITE folder contents.

Copying Files

Files can be copied from the camera's built-in memory to a memory card, or from a memory card to built-in memory.

This makes it possible, for example, to perform the following steps and copy a file from your memory card to another person's memory card.

- ① Copy the file from your memory card to the camera's built-in memory.
- ② Remove your memory card and insert the other person's memory card.
- ③ Copy the file from built-in memory to the other memory card.



IMPORTANT!

- You can copy snapshots, movies, audio snapshots, or Voice Recording files you recorded with your camera.
- You cannot copy a snapshot that is in the FAVORITE folder.

■ Copying All Files in Built-in Memory to a Memory Card

The following operation copies all files from built-in memory to a memory card. You cannot copy files individually.

- 1. Load the memory card to which you want to copy the files into the camera.**
- 2. Turn on the camera, enter the PLAY mode and then press [MENU].**
- 3. On the “PLAY” tab, select “Copy” and then press [▶].**
- 4. Use [▲] and [▼] to select “Built-in → Card” and then press [SET].**

This starts the copy operation. Wait until the “Busy... Please wait...” message disappears from the monitor screen before performing any operation on the camera.

- After the copy operation is complete, the last file copied will be displayed on the monitor screen.

■ Copying a Single File from a Memory Card to Built-in Memory

With this procedure, files must be copied one-by-one.

1. Load the memory card that contains the file you want to copy into the camera.
2. Turn on the camera, enter the **PLAY** mode and then press **[MENU]**.
3. On the “**PLAY**” tab, select “**Copy**” and then press **[▶]**.
4. Use **[▲]** and **[▼]** to select “**Card → Built-in**” and then press **[SET]**.
5. Use **[◀]** and **[▶]** to select the file you want to copy.
6. Use **[▲]** and **[▼]** to select “**Copy**” and then press **[SET]**.

This starts the copy operation. Wait until the “Busy... Please wait...” message disappears from the monitor screen before performing any operation on the camera.

- The copied image reappears on the monitor screen after the copy operation is complete.

7. Now you can repeat steps 5 and 6 to copy another file, or you can exit this procedure by pressing **[MENU]**.

NOTE

- Files are copied to the folder in built-in memory whose name has the largest serial number.

DELETING FILES

You can delete files you no longer need, or after you transfer them to your computer's hard disk or print them. This frees up memory for new files.

You can delete one specific file, or you can delete all files currently in memory.

Here we will explain the different file delete procedures, including how to delete snapshots from the FAVORITE folders.



IMPORTANT!

- Remember that a file delete operation cannot be undone. Always make sure that you really no longer need a file before deleting it.
- A protected file cannot be deleted. To delete a protected file, first remove its protection (page 180).
- Deleting an audio snapshot deletes both the snapshot and the audio file.

Deleting a Specific File

1. In the **PLAY** mode, press [▼] (⚡ 🗑️).

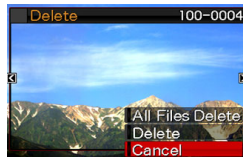

2. Use [◀] and [▶] to scroll through the images until the one for the file you want to delete is on the monitor screen.
3. Use [▲] and [▼] to select “Delete” and then press [SET].
 - To exit the delete operation without deleting anything, select “Cancel”.
4. Now you can repeat steps 2 and 3 to delete another file, or you can exit this procedure by pressing [MENU].

Deleting All Files

1. In the **PLAY** mode, press [**▼**] (⏏).
2. Use [**▲**] and [**▼**] to select “All Files Delete” and then press [**SET**].
3. In response to the confirmation message that appears, use [**▲**] and [**▼**] to select “Yes”.
 - To cancel the delete operation, select “No” instead of “Yes”.
4. Press [**SET**].
 - This deletes all of the files and displays the message “There are no files.”

Deleting FAVORITE Folder Snapshots

You can delete a single snapshot, or you can delete all the snapshots currently in the FAVORITE folder.

■ Deleting a Specific Snapshot

1. In the **PLAY** mode, press [**MENU**].
2. On the “PLAY” tab, select “Favorites” and then press [**▶**].
3. Use [**▲**] and [**▼**] to select “Show” and then press [**SET**].
4. Press [**▼**] (⏏).
5. Use [**◀**] and [**▶**] to select the snapshot you want to delete.
6. Use [**▲**] and [**▼**] to select “Delete” and then press [**SET**].

7. Now you can repeat steps 5 and 6 to delete another FAVORITE folder snapshot, or you can exit this procedure by pressing [MENU] twice.

■ Deleting All FAVORITE Folder Snapshots

1. In the PLAY mode, press [MENU].
2. On the “PLAY” tab, select “Favorites” and then press [▶].
3. Use [▲] and [▼] to select “Show” and then press [SET].
4. Press [▼] (⚡ 🗑️).
5. Use [▲] and [▼] to select “All Files Delete” and then press [SET].

NOTE

- All snapshots in the FAVORITE folder are also deleted whenever you format built-in memory (page 199).

OTHER SETTINGS

Configuring Camera Sound Settings

Your camera lets you configure the following sound settings.

- Type of sound for shutter release and other operations
- Volume level for shutter release and other operation sounds
- Volume level for movie and Voice Recording playback

■ Selecting the Operation Sound

1. Press [MENU].
2. On the “Set Up” tab, select “Sounds” and then press [▶].
3. Use [▲] and [▼] to select the operation whose sound you want to configure (Startup, Half Shutter, Shutter, Operation) and then press [▶].

4. Use [▲] and [▼] to select the setting you want and then press [SET].

To do this:	Select this setting:
Sound one of the built-in sounds (1 through 5)	Sound 1 - 5
Turn sound off	Off

■ Setting the Operation Tone Volume Level

1. Press [MENU].
2. On the “Set Up” tab, select “Sounds” and then press [▶].
3. Use [▲] and [▼] to select “ Operation”.
4. Use [◀] and [▶] to specify the playback volume setting you want and then press [SET].
 - You can set the volume to one of eight levels in the range of 0 (lowest) to 7 (highest).
 - Setting a volume level of 0 mutes the sound.

NOTE

- The volume setting you configure here is also applied to video output (page 151).

■ Setting the Playback Volume Level

You can use this procedure to set the playback volume level for movies and audio snapshots, independent of the operation tone volume.

1. Press [MENU].
2. On the “Set Up” tab, select “Sounds” and then press [▶].
3. Use [▲] and [▼] to select “ Play”.
4. Use [◀] and [▶] to specify the operation tone volume setting you want and then press [SET].
 - You can set the volume to one of eight levels in the range of 0 (lowest) to 7 (highest).
 - Setting a volume level of 0 mutes the sound.



IMPORTANT!

- The volume setting you configure here does not affect the video output (page 151).

Turning the Startup Screen On or Off

You can configure the camera to display a startup screen of an image you recorded, whenever you turn it on.

- The startup screen is not displayed when you turn on the camera by pressing [▶] (PLAY).

1. Press [MENU].
2. On the “Set Up” tab, select “Startup” and then press [▶].
3. Use [◀] and [▶] to scroll through the images until the one you want to use as the startup screen is on the monitor screen.
4. Use [▲] and [▼] to select the setting you want and then press [SET].

To do this:	Select this setting:
Use the selected image as the startup screen	On
Turn off the startup screen	Off

NOTE

- The following are the types of images that you can select for the startup screen.
 - Special startup screen images built into the camera
 - Snapshots
 - Audio snapshots (Audio does not play.)
- Only one startup screen image can be in effect at any time. To change the startup screen to another image, simply overwrite the current image with the new one.
- Formatting built-in memory (page 199) will delete the current startup screen image.

Specifying the File Name Serial Number Generation Rule

Use the following procedure to specify the rule that governs generation of the serial number used in file names (page 179).

1. Press [MENU].
2. On the “Set Up” tab, select “File No.” and then press [▶].
3. Use [▲] and [▼] to select the setting you want and then press [SET].

To have the camera do this:	Select this setting:
Remember the current number and always assign the next one, even if all files are deleted or if the memory card is replaced.	Continue
Restart the serial number from 0001 whenever all files are deleted or the memory card is replaced.	Reset

Changing the Camera Date and Time Setting

When changing the date and time setting, be sure to do so for your Home City (the location where you normally use the camera). If you already have your Home City setting configured correctly, you can use the procedure under “Setting the Date and Time for Your Home City” (page 193) to change the current time setting only, if you want.

IMPORTANT!

- Changing the time and date setting without correctly configuring your Home City setting first will cause all of the World Time (page 194) dates and times to be off.

■ Selecting Your Home City

1. Press [MENU].
2. On the “Set Up” tab, select “World Time” and then press [▶].

This displays the current World Time settings.

3. Use [▲] and [▼] to select “Home” and then press [▶].
4. Use [▲] and [▼] to select “City” and then press [▶].
5. Use [▲], [▼], [◀], and [▶] to select the area where your Home City is located and then press [SET].
6. Use [▲] and [▼] to select your home city and then press [SET].
7. After the setting is the way you want, press [SET] to exit the setting screen.

■ Setting the Date and Time for Your Home City

1. Press [MENU].
2. On the “Set Up” tab, select “Adjust” and then press [▶].
3. Set the date and the time.

To do this:	Press this button:
Move the cursor between settings	[◀] or [▶]
Change the setting at the cursor location	[▲] or [▼]
Toggle between 12-hour and 24-hour format	[BS]

4. After all of the settings are the way you want, press [SET] to exit the setting screen.

■ Changing the Date Format

You can select from among three different formats for the date.

1. Press [MENU].
2. On the “Set Up” tab, select “Date Style” and then press [▶].
3. Use [▲] and [▼] to select the setting you want and then press [SET].

Example: December 19, 2006

To display the date like this:	Select this format:
06/12/19	YY/MM/DD
19/12/06	DD/MM/YY
12/19/06	MM/DD/YY

Using World Time

You can use the World Time screen to view the current time in zone that is different from your Home City when you go on a trip, etc. World Time displays the current time in 162 cities in 32 time zones around the globe.

Configuring World Time Settings

1. Press [MENU].
2. On the “Set Up” tab, select “World Time” and then press [▶].
3. Use [▲] and [▼] to select “World” and then press [▶].

4. Use [▲] and [▼] to select “City” and then press [▶].

- To configure the summer time setting, use [▲] and [▼] to select “DST” and then select “On”.
- Summer time is used in some areas to advance the current time setting by one hour during the summer months.
- Use of summer time depends on the local customs and laws.



5. Use [▲], [▼], [◀], and [▶] to select the area where the city you want to view is located and then press [SET].

6. Use [▲] and [▼] to select the city you want and then press [SET].

7. After the setting is the way you want, press [SET] to exit the setting screen.

■ Switching between the Home Time and World Time Screens

- 1. Press [MENU].**
- 2. On the “Set Up” tab, select “World Time” and then press [▶].**
- 3. Use [▲] and [▼] to select “World” for the World Time screen, or “Home” for the Home Time screen.**
- 4. After selecting the screen you want, press [SET] to exit the setting screen.**

Changing the Display Language

You can use the procedure below to select a display text language.

- The number and types of languages depend on the geographic area where the camera was marketed.

- 1. Press [MENU].**
- 2. On the “Set Up” tab, select “Language” and then press [▶].**
- 3. Use [▲], [▼], [◀], and [▶] to select the setting you want and then press [SET].**

Changing the USB Port Protocol

You can use the procedure below to change the USB communication protocol that is used when exchanging data with a computer, printer, or other external device. Select the protocol that suits the device to which you are connecting.

- 1. Press [MENU].**
- 2. On the “Set Up” tab, select “USB” and then press [▶].**

3. Use [▲] and [▼] to select the setting you want and then press [SET].

When you want to connect to this type of device:	Select this setting:
Computer With this setting, the computer sees the camera as an external storage device. Use this setting for normal transfer of images from the camera to a computer (using the bundled Photo Loader application).	Mass Storage
Printer that supports PictBridge (page 202) This setting simplifies the transfer of image data to the connected device.	PTP (PictBridge)

[📷] (REC) and [▶] (PLAY) Button Settings

You configure the camera so it does not turn on when you press the [📷] (REC) or [▶] (PLAY) button, or to turn off when you press the [📷] (REC) or [▶] (PLAY) button.

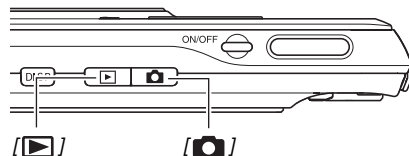

1. Press [MENU].
2. On the “Set Up” tab, select “REC/PLAY” and then press [▶].

3. Use [▲] and [▼] to select the setting you want and then press [SET].

To configure both keys to do this when pressed:	Select this setting:
Turn on the camera	Power On
Turn on or turn off the camera	Power On/Off
Do not turn on the camera	Disable

NOTE

- With “Power On/Off”, the camera turns off when you press [📷] (REC) in the REC mode or [▶] (PLAY) in the PLAY mode.
- Pressing [▶] (PLAY) while in the REC mode or [📷] (REC) while in the PLAY mode will switch to the applicable mode (REC or PLAY).
- Pressing [📷] (REC) or [▶] (PLAY) while the camera is on switches immediately to the applicable mode (REC or PLAY), even if you are performing a menu operation.
- The initial factory default for this setting is “Power On”.
- Change this setting to anything besides “Disable” before connecting to a TV for image viewing.

Formatting Built-in Memory

Formatting built-in memory deletes any data stored in it.

IMPORTANT!

- Note that data deleted by a format operation cannot be recovered. Check to make sure you do not need any of the data in built-in memory before you format it.
- Formatting built-in memory also deletes the following.
 - Protected images
 - FAVORITE folder images
 - BEST SHOT mode user setups
 - Startup screen
- Make sure that the battery is charged fully before starting a formatting operation. Formatting may not be performed correctly and the camera may stop operating normally if the camera powers down while formatting is in progress.
- Never open the battery cover while formatting is in progress. Doing so can cause the camera to stop operating normally.

1. Check to make sure there is no memory card loaded in the camera.

- If there is a memory card loaded in the camera, remove it.

2. Press [MENU].

3. On the “Set Up” tab, select “Format” and then press [▶].

4. Use [▲] and [▼] to select “Format” and then press [SET].

This formats built-in memory.

- To exit the format operation without formatting, select “Cancel”.
- Entering the PLAY mode after formatting the built-in memory will cause the message “There are no files.” to appear.

PRINTING

Types of Printing

There are three different methods you can use for printing images.

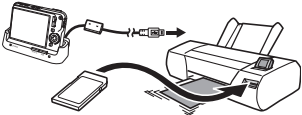
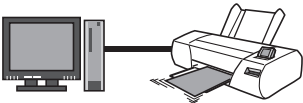
Professional Print Service (page 201)		<p>Take the memory card that contains the images you want to print to a professional print service.</p> <ul style="list-style-type: none">• You can use DPOF settings to specify which images you want to print, the number of copies, and date stamp settings before taking the card in for printing.
Printing at Home	<p>Printing on a Printer (page 202)</p> 	<p>Print on a printer that supports PictBridge, or on a printer equipped with a memory card slot.</p> <ul style="list-style-type: none">• You can use DPOF settings to specify which images you want to print, the number of copies, and date stamp settings before printing.
	<p>Printing with a Computer</p> 	<p>■ Windows Computer</p> <p>Install the software (Photohands) that comes bundled with the camera. See “Using the Camera with a Windows Computer” on page 212.</p> <p>■ Macintosh</p> <p>After transferring the images to your Macintosh, use commercially available software to print. See “Using the Camera with a Macintosh” on page 235.</p>

■ Printing Precautions

- See the documentation that comes with your printer for information about print quality and paper settings.
- Contact the manufacturer of your printer to find out if it supports PictBridge, for new printer versions, etc.
- Never disconnect cables or perform any camera or USB cradle operation while printing is in progress. Doing so can cause a printer error.

Precaution when printing with “All Images”

Note that selecting “All Images” for printing will also print all the pages of all the documents that have been transferred to the camera using the Data Storage feature (page 249).

Regardless of whether you are printing at home or if you are using an outside printing service, make sure you know what is stored in a memory card (especially documents) before selecting “All Images” (page 207).

Using Professional Print Service

Take a memory card that contains the images you want to print to the professional print service. Before taking in a memory card, you can use the camera’s DPOF settings (page 205) to specify which images you want printed, the number of copies, and whether or not the images should include a date stamp.

Using Your Printer to Print Images

If your printer is either of the types described below, you can use it to print without going through a computer.

- Printer equipped with an SD memory card/ SDHC memory card slot
- Printer that support PictBridge

■ Printing on a Printer with an SD Memory Card/SDHC Memory Card Slot

Remove the SD memory card or SDHC memory card from the camera and insert it directly into the printer's memory card slot. Depending on what type of printer you are using, it also may be able to read the settings (images to be printed, number of copies, date stamping) you configure with the camera's DPOF settings (page 205). For details, see the user documentation that comes with your printer.

■ Printing on a Printer that Supports PictBridge

You can connect the camera directly to a PictBridge compliant printer and print images without going through a computer.

- The camera's USB cradle also allows easy connection to a printer. Before connecting to a printer via the USB cradle, be sure to perform the following procedure first.

1. Press [MENU].
2. On the "Set Up" tab, select "USB" and then press [▶].
3. Use [▲] and [▼] to select "PTP (PictBridge)" and then press [SET].

4. Connect the USB cable that comes bundled with the camera to the USB cradle and your printer's USB port.

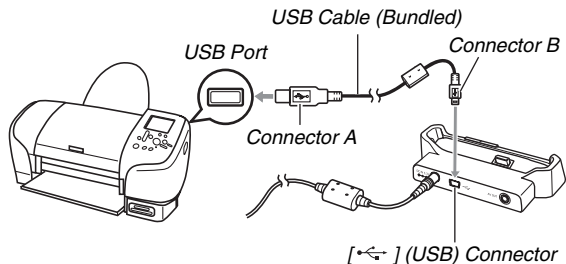

- Also, connect the AC adaptor to the cradle and plug the adaptor into an electrical outlet.
- If you do not plan to use the AC adaptor, make sure that the camera's battery is fully charged.
- Nothing appears on the camera's monitor screen if the camera is on the USB cradle while the bundled AV cable is connected to the cradle. Be sure to disconnect the AV cable from the cradle if you want to use the camera's monitor screen to view images.

5. Turn off the camera and place it onto the USB cradle.

6. Turn on the printer.

7. Load paper into the printer.

8. Press the USB cradle's [USB] button.

This displays a print menu on the camera's monitor screen.



9. Use [▲] and [▼] to select “Paper Size” and then press [▶].

10. Use [▲] and [▼] to select a paper size and then press [SET].

- The following are the available paper sizes.
3.5" × 5", 5" × 7", 4" × 6", A4, 8.5" × 11", By Printer
- Selecting “By Printer” prints using a paper size selected on the printer.
- Available paper settings depend on the connected printer. For full details, see the user documentation that comes with your printer.

11. Use [▲] and [▼] to specify the print option you want.

If you want to print a specific image:

Select “1 Image” and then press [SET]. After that, use [◀] and [▶] to display the image you want to print.

If you want to print multiple images:

Select “DPOF Printing” and then press [SET]. Next, use the DPOF settings (page 205) to specify the images you want to select.

- To toggle date stamping on and off, press [BS]. The date stamp will be printed when “On” is indicated on the monitor screen.



12. Use [▲] and [▼] to select “Print” and then press [SET].

Printing will start and the message “Busy... Please wait...” will appear on the monitor screen. The message will disappear after a short while, even though printing is still being performed. Pressing any camera button will cause the printing status message to re-appear.

The print menu screen will re-appear when printing is complete.

- If you selected “1 Image” in step 11, you can repeat the procedure from step 11 to print other images, if you want.

13. After you are finished printing, press the USB cradle’s [USB] button.

This will turn off the camera.

Using DPOF to Specify Images to be Printed and the Number of Copies

DPOF (Digital Print Order Format) lets you specify which images you want to print, the number of copies, and whether date stamping is turned on or off. The settings you configure are recorded on the memory card. After configuring settings you can use the memory card to print on a home printer that supports DPOF or take the memory card to a professional print service. With DPOF, you can configure settings while viewing the actual images on the camera’s monitor screen, so there is no need to recall hard-to-remember files names, etc.



IMPORTANT!

- Certain print service providers may not support DPOF or may support different printing protocols. In this case, you will need to perform printing in accordance with the instructions provided by the print service you are using.

■ Configuring DPOF Settings Individually for Each Image

1. In the **PLAY** mode, press **[MENU]**.
2. On the “**PLAY**” tab, select “**DPOF Printing**” and then press **[▶]**.
3. Use **[▲]** and **[▼]** to select “**Select Images**” and then press **[▶]**.
4. Use **[◀]** and **[▶]** to scroll through the images until the one you want to print is on the monitor screen.

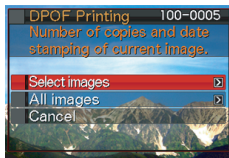

5. Use **[▲]** and **[▼]** to specify the number of copies.
 - You can specify up to 99 for the number of copies. Specify 0 if you do not want to print the image.
6. If you want to include the date in the image, press **[BS]** to toggle date stamping on and off.
 - To turn off date stamping, press **[BS]** so “Off” is displayed.
 - Repeat steps 4 through 6 to configure settings for other images, if you want.
7. After everything is the way you want, press **[SET]** to save the settings.

■ Configuring the Same DPOF Settings for All the Images

1. In the **PLAY** mode, press [MENU].
2. On the “**PLAY**” tab, select “**DPOF Printing**” and then press [▶].
3. Use [▲] and [▼] to select “**All images**” and then press [▶].
4. Use [▲] and [▼] to specify the number of copies.
 - You can specify up to 99 for the number of copies. Specify 0 if you do not want to print.
5. If you want to include the date in the images, press [BS] to toggle date stamping on and off.
 - To turn off date stamping, press [BS] so “Off” is displayed.
6. After everything is the way you want, press [SET] to save the settings.

Clear DPOF settings when you no longer need them!

DPOF settings are not cleared automatically after printing is complete. This means that if you perform another printing operation without clearing DPOF settings, printing will be performed in accordance with the last settings you configured. If you no longer need the currently configured DPOF settings, use the procedure under “Configuring the Same DPOF Settings for All the Images” to change the number of copies setting for all the images to 00.

Tell your print service about your DPOF settings!

If you take a memory card to a professional print service, be sure to tell them that it includes DPOF settings for the images to be printed and the number of copies. If you don't, the print service may print all the images without regard to your DPOF settings, or they may ignore your date stamp setting.

IMPORTANT!

- Some printers may ignore time stamp settings or may not support DPOF at all. Check the user documentation that comes with your printer for details.

Date Stamping

You can use any one of the following three methods to include the recording date in the printout of an image.

- **Configure DPOF settings on the camera to specify date stamping (page 205)**
 - If an image already has the date or time stamped into it using the camera's Date Stamping feature, turning on DPOF date stamping will cause the two dates to be stamped in the same location. Be sure to turn off DPOF date stamping when printing an image that is stamped with the camera's Date Stamping function.
 - Some printers may ignore time stamp settings or may not support DPOF at all. Check the user documentation that comes with your printer for details.
 - Note that some professional print services do not support DPOF printing. Check with your service before ordering prints.
- **The camera's Date Stamping feature stamps the date and time directly into the image data (page 131).**

- **Specify date stamping with Photohands (Windows only)**
 - See the Photohands User's Guide for details. The Photohands User's Guide is provided as a PDF file on the CD-ROM that comes bundled with your camera.
- **Request date stamping when ordering prints from a professional print service**
 - Some print services do not support date printing. Check with your service for more information.

Supported Protocols

Your camera supports the protocols described below.

■ PictBridge

Camera and Imaging Products Association
(CIPA)



■ PRINT Image Matching III

Using image editing software and printing on a printer that also supports PRINT Image Matching III makes it possible to use information about shooting conditions that is recorded with the image, and produce exactly the type of image you want.

PRINT Image Matching and PRINT Image Matching III are trademarks of Seiko Epson Corporation.



■ Exif Print

Printing on a printer that also supports Exif Print (Exif 2.2) uses information about shooting conditions recorded with the image to enhance printed image quality.

Contact your printer manufacturer for information about models that support Exif Print, printer upgrades, etc.



USING THE CAMERA WITH A COMPUTER

What you can do

Connecting the camera to a computer with the bundled USB cable provides you with the capabilities described below.

View and store images*	<p>You can use your computer to view camera images and for long-term storage of images.</p> <ul style="list-style-type: none">• With some versions of Windows you need to install the USB driver that comes bundled with the camera.• Installation of a USB driver is not required for the Apple Macintosh.
Manage, edit, and print images	<p>You can use the software that comes bundled with the camera to perform various operations with the images stored on your computer's hard disk.</p> <ul style="list-style-type: none">• Refer to the explanations later in this section and install the required software on your computers.

Transfer images to the camera	<p>You can transfer images stored on your computer to camera memory.</p> <ul style="list-style-type: none">• You can even transfer images that were not originally recorded with the camera. You can capture (cut) a portion of the image (web page, map, etc.) currently on your computer screen and transfer it to camera memory.
Transfer documents to the camera	<p>You can transfer documents from your computer to camera memory.</p>

- * You can also transfer images to a computer for viewing and storage without connecting the camera, by removing the memory card from the camera and reading the contents of the card with your computer (page 244).

The procedures you need to perform when using the camera with your computer and when using the bundled software are different for Windows and the Macintosh.

- Windows users should refer to “Using the Camera with a Windows Computer” on page 212.
- Macintosh users should refer to “Using the Camera with a Macintosh” on page 235.

IMPORTANT!

- This camera supports USB 2.0 Hi-Speed protocol. Though it can be used with a computer that supports only USB 1.1 protocol, higher speed data transfer becomes possible when USB 2.0 Hi-Speed is supported. Note that certain computer models, connecting through a USB hub, and other system conditions can slow down data transfer and even cause operational problems.



Using the Camera with a Windows Computer

Install the required software in accordance with what version of Windows you are running and what you want to do.

Objective	Windows Version	Install this software:	See page:
<ul style="list-style-type: none"> • Viewing images on a computer • Storing images on a computer 	XP/2000/Me	– (USB driver not required.)	–
	98SE/98	USB driver Type B (USB driver. Be sure to install this driver.)	216
Transfer of images from the camera and management of images on the computer	XP/2000/Me/98SE/98	Photo Loader 3.0 DirectX 9.0c (When DirectX 9.0 or higher is not installed on the computer already.)	224
Retouch, rotate, print snapshots	XP/2000/Me/98SE/98	Photohands 1.0	227

Objective	Windows Version	Install this software:	See page:
Play movies	XP/2000	DivX Player (DivX Play Bundle) <ul style="list-style-type: none"> Install DivX Player and the DivX codec (DivX Play Bundle). Windows Media Player *DivX codec (DivX Play Bundle) <ul style="list-style-type: none"> Installing the DivX codec also enables movie playback with Windows Media Player. 	228
Transfer images to the camera	XP/2000/Me/98SE/98	Photo Transport 1.0	229
Transfer documents to the camera	XP/2000	CASIO DATA TRANSPORT 1.0	249

Objective	Windows Version	Install this software:	See page:
View the User's Guide	XP/2000/Me/98SE	Adobe Reader 6.0 (Not required if already installed.)	233
	98	– <ul style="list-style-type: none"> If your computer does not have Adobe Reader or Adobe Acrobat Reader installed already, go to the Adobe Systems Incorporated website to download and install Acrobat Reader 5.0.5. 	–

■ Computer System Requirements

Computer system requirements are different for each of the applications. Be sure to check the requirements for the particular application you are trying to use. Note that the values provided here are minimum requirements for running each application. Actual requirements are greater, depending on the number of images and the sizes of the images being handled.

USB driver Type B

- Installation is not required in the case of Windows XP, 2000, and Me.
- Correct operation is not guaranteed on a computer that has been upgraded from Windows 95 or 3.1.

Photo Loader 3.0

HD : At least 40MB

Other: IE 5.5 or higher, DirectX 9.0 or higher

Photohands 1.0

HD: At least 10MB

DirectX 9.0c

HD: 65MB for installation (18MB on hard disk)

Photo Transport 1.0

Memory: At least 64MB

HD : At least 2MB

CASIO DATA TRANSPORT 1.0

- Sufficient memory to run the operating system

Adobe Reader 6.0

CPU : Pentium

Memory: 32MB

HD : 60MB

Other : Internet Explorer 5.01 or higher

DivX Player (DivX Play Bundle)

OS : XP/2000

CPU : Pentium III 733MHz

Memory: At least 64MB

HD : At least 10MB

IMPORTANT!

- For details about the minimum system requirements for each software application, see the “Read me” files on the CD-ROM that comes bundled with the camera.
- Visit the URL below for more information if you have any questions or problems with the DivX codec.
<http://www.divx.com/support/>

Viewing and Storing Images on a Computer

You can view and store images (snapshot and movie files) on your computer by connecting to the camera via its USB cradle.

- Depending on what version of Windows your computer is running, you may need to install the USB driver from the bundled CD-ROM first.

General Procedure

1) If your computer is running Windows 98SE or 98, install the USB driver (page 216). If your computer is running Windows XP, 2000, or Me, proceed directly to step 2.



2) Use the USB cradle to connect the camera and computer (page 217).



3) View and copy the images you want (page 221).

■ Installing the USB Driver (Windows 98SE and 98 Only)

Do not try to establish a connection between the camera and computer before installing the USB driver on the computer.

If you do, the computer will not be able to recognize the camera.

If your computer is running Windows 98SE or 98, be sure to install the USB driver.

Do not connect the camera to your computer without installing the USB driver first.

The following operation shows how to install the USB driver on a computer running Windows 98. The procedure for Windows 98SE is slightly different, but the general flow is the same.

- 1. Set the bundled CD-ROM into the CD-ROM drive of your computer.**
 - This will display the menu screen.
- 2. On the menu screen, click the “English” tab.**
 - You could also click another language tab, if you prefer.
- 3. Click “Install” for “USB driver B” to start installation.**
- 4. Follow the instructions that appear on the dialog box and click “Next”.**

5. When the final screen is reached, click “Finish”.

- Depending on the version of Windows that your computer is running, a message may appear telling you to restart your computer. If your computer displays such a message, restart.

6. To exit the installer, click [Exit] to close the CD-ROM menu and then remove the CD-ROM from your computer.

- Depending on what version of Windows your computer is running, your computer may restart automatically. If this happens, the CD-ROM menu may re-appear after the restart. Click “Exit” to exit the CD-ROM menu and then remove the CD-ROM from your computer.

■ Connecting the Camera to Your Computer the First Time



IMPORTANT!

- If you are not using the AC adaptor to power the camera, the battery may go low and cause the camera to turn off while it is in the middle of exchanging files with your computer. Use of the special AC adaptor is recommended to power the camera.

1. Connect the bundled AC adaptor to the [DC IN 5.3V] connector of the USB cradle and then plug it in to a household power outlet.

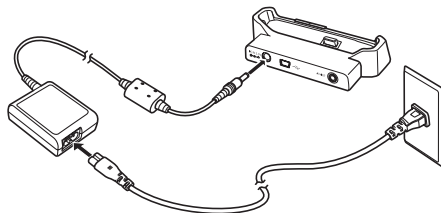

- If you do not plan to use the AC adaptor, make sure that the camera's battery is fully charged.

2. Connect the USB cable that comes bundled with the camera to the USB cradle and the USB port of your computer.

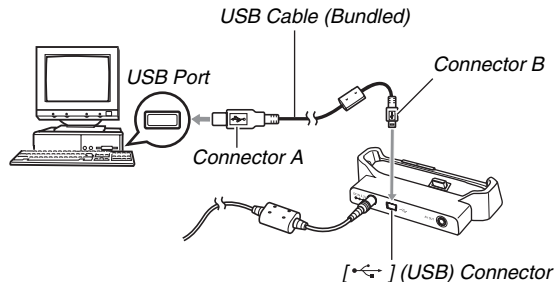

- Orient the USB plug so it correctly matches the shape of the USB port when you connect them.
- Plug the USB cable into the ports securely, as far as it will go. Proper operation is not possible if connections are not correct.

3. Press the camera's [ON/OFF] button to turn it on and then press [MENU].

- Do not place the camera on the USB cradle yet.

4. On the "Set Up" tab, select "USB" and then press [▶].

5. Use [▲] and [▼] to select "Mass Storage" and then press [SET].

6. Press the camera's [ON/OFF] button to turn it off and then place the camera on the USB cradle.

- Do not place the camera onto the USB cradle while it is turned on.
- If you plan to transfer images from the camera's built-in memory to your computer, make sure there is no memory card loaded in the camera.

7. Press the USB cradle's [USB] button.

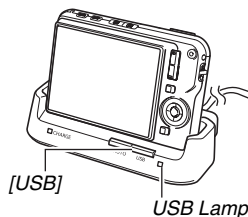

Camera-Computer Connection

Pressing the cradle's [USB] button puts it into the USB mode, which is indicated by the USB lamp lighting green. In this mode, your computer recognizes the memory card loaded in the camera (or the camera's built-in memory if it does not have a memory card loaded) as a removable disk.

From now on, you will not have to perform steps 3 through 5 in the above procedure when you connect the camera to your computer (unless you change the camera's USB settings for some reason).

- With some Windows setups, you may see a guidance message appear on your display to let you know about the new removable disk. If this happens, simply close the guidance message dialog box.



IMPORTANT!

- Never disconnect the USB cable or remove the camera from the USB cradle without exiting the USB mode first. Doing so can corrupt image data. See “Removing the Camera from the USB Cradle” on page 224 for the correct steps you need to perform to remove the camera from the cradle safely.

■ Connecting the Camera to Your Computer after the First Time

Since you need to install the USB driver and configure menu settings only the first time you connect the camera to your computer, later connections are much simpler.

1. Press the camera's [ON/OFF] button to turn it off and then place the camera on the USB cradle.

- Do not place the camera onto the USB cradle while it is turned on.
- If you plan to transfer images from the camera's built-in memory to your computer, make sure there is no memory card loaded in the camera.

2. Press the USB cradle's [USB] button.

- Pressing the cradle's [USB] button puts it into the USB mode, which is indicated by the USB lamp lighting green.

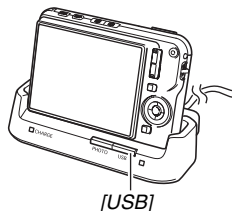

■ Viewing Camera Images on Your Computer

After connecting the camera to your computer, you can view camera images on your computer screen.

- For information about connecting to a computer, see “Connecting the Camera to Your Computer after the First Time” on page 221.

1. Windows XP users: Click “Start” and then “My Computer”.

Windows 2000/Me/98SE/98 users: Double-click “My Computer”.

2. Double-click “Removable Disk”.

- Your computer recognizes the memory card loaded in the camera (or built-in memory if there is no card) as a removable disk.

3. Double-click the “DCIM” folder.

4. Double-click the folder that contains the image you want to view.

5. Double-click the file that contains the image you want to view.

This displays the image.

- For information about file names, see “Memory Folder Structure” on page 246.

NOTE

- An image that was rotated on the camera will be displayed on your computer screen in its original (unrotated) orientation.

■ Saving an Image on Your Computer

In order to work on an image or put it into an album, you must first save it to your computer. To save a camera image to your computer, you must first establish a connection between them via the camera’s USB cradle.

- For information about connecting to a computer, see “Connecting the Camera to Your Computer after the First Time” on page 221.

1. Windows XP users: Click “Start” and then “My Computer”.

Windows 2000/Me/98SE/98 users: Double-click “My Computer”.

2. Double-click “Removable Disk”.

- Your computer recognizes the memory card loaded in the camera (or built-in memory if there is no card) as a removable disk.

3. Right-click the “DCIM” folder.

4. On the shortcut menu that appears, click “Copy”.

5. Windows XP users: Click “Start” and then “My Documents”.

Windows 2000/Me/98SE/98 users: Double-click “My Documents” to open it.

- If you already have a “DCIM” folder in “My Documents”, the next step will overwrite it. If you want to keep the existing “DCIM” folder, you need to change its name or move it to a different location before performing the next step.

6. On the “My Document” “Edit” menu, select “Paste”.

This will paste the “DCIM” folder (and all the image files it contains) into your “My Documents” folder. You now have a copy of the files that are in camera memory on your computer.



IMPORTANT!

- Never use your computer to modify, delete, move, or rename any image files that are in the camera’s built-in memory or memory card. Doing so can cause problems with the camera’s image management data, which will make it impossible to play back images on the camera and can drastically alter remaining memory capacity. Whenever you want to modify, delete, move, or rename an image, do so only on images that are stored on your computer.
- Never unplug the USB cable, or operate the camera or cradle while viewing or storing images. Doing so can cause data to become corrupted.

■ Removing the Camera from the USB Cradle

Windows XP/98SE/98 Users

Press the USB cradle [USB] button. After making sure that the cradle's USB lamp is not lit, remove the camera from the cradle.

Windows 2000/Me Users

Click card services in the task tray on your computer screen, and disable the drive number assigned to the camera. Next, press the USB cradle [USB] button. After making sure that the cradle's USB lamp is not lit, remove the camera from the cradle.

Transfer of Images from the Camera and Management of Images on the Computer

To manage images on your computer, you need to install the Photo Loader application from the CD-ROM that comes with the camera.

Photo Loader lets you import images from the camera to your computer automatically, to arrange images by recording date, and to display images in a calendar format.

NOTE

- If you already have Photo Loader installed on your computer, check its version. If the bundled version is newer than the one you have, uninstall the old version of Photo Loader and then install the newer version.

■ Installing Photo Loader

1. Start up your computer, and place the bundled CD-ROM into its CD-ROM drive.

- Normally, this should cause the menu screen to appear automatically. If your computer does not display the menu screen automatically, navigate to the CD-ROM on your computer and then double-click the "MENU.exe" file.

2. On the menu screen, click the tab for the language you want.

3. Click the Photo Loader "Read me" file and read its contents.

- "Read me" files contain important information about installation, including installation conditions and computer system requirements.

4. Click "Install" for Photo Loader.

5. Follow the instructions that appear on your computer screen to install Photo Loader.

- Windows 98SE/98

If the Jet40SP8_9xNT.exe and MDAC (Microsoft Data Access Components) 2.8 installation dialog box appears after installation of Photo Loader is complete, follow the instructions on the screen to perform the installation. The installation dialog box will not appear if Jet40SP8_9xNT.exe and MDAC 2.8 or higher are already installed on your computer.

- Windows XP (including SP1), 2000, or Me (Excluding Windows XP SP2)

If the MDAC (Microsoft Data Access Components) 2.8 installation dialog box appears after installation of Photo Loader is complete, follow the instructions on the screen to perform the installation. The installation dialog box will not appear if MDAC 2.8 or higher is already installed on your computer.

IMPORTANT!

- See the “Read me” file that comes with Photo Loader for information about what you need to do to be able to use existing libraries after updating, re-installing Photo Loader, or moving Photo Loader to another computer. If you do not follow the correct procedure for installation, you may not be able to display existing library information or calendar format HTML files with Photo Loader, or imported image files may be deleted.

Checking Your Computer’s DirectX Version

In order to manage images using Photo Loader, your computer also needs to have Microsoft DirectX 9.0 or higher installed. You can check the installed version of Microsoft DirectX using your PC’s DirectX Diagnostic Tool.

- 1. On your computer, click “Start”, “All Programs”, “Accessories”, “System Tools” and then “System Information”.**
- 2. On the “Tools” menu, select “DirectX Diagnostic Tool”.**
- 3. On the “System” tab, check to make sure that the “DirectX Version” is 9.0 or higher.**
- 4. Click “Exit” to exit the DirectX Diagnostic Tool.**
 - If your PC already has Microsoft DirectX 9.0 or higher installed, you do not need to install Microsoft DirectX 9.0c from the bundled CD-ROM.
 - If your computer does not have Microsoft DirectX 9.0 or higher installed, install Microsoft DirectX 9.0c from the bundled CD-ROM.

Retouching, Reorienting, or Printing Snapshots

In order to retouch, reorient, or print snapshots on your PC, you need to install Photohands from the CD-ROM that comes bundled with the camera.

IMPORTANT!

- If you already have Photohands installed on your computer, check its version. If the bundled version is newer than the one you have, uninstall the old version of Photohands and then install the newer version.

■ **Installing Photohands**

1. Start up your computer and place the bundled CD-ROM into its CD-ROM drive.

- Normally, this should cause the menu screen to appear automatically. If your computer does not display the menu screen automatically, navigate to the CD-ROM on your computer and then double-click the "MENU.exe" file.

2. On the menu screen, click the tab for the language you want.

3. Click the Photohands "Read me" file and read its contents.

- "Read me" files contain important information about installation, including installation conditions and computer system requirements.

4. Click "Install" for Photohands.

5. Follow the instructions that appear on your computer screen to install Photohands.

Playing Movies

To play back a movie, first copy the movie to your computer and then double-click the movie file.

In order to play a movie recorded with this camera on a Windows computer, you need to install DivX Player and the DivX codec (DivX Play Bundle) from the CD-ROM that comes bundled with the camera.

- Installing the DivX codec also enables movie playback with Windows Media Player.

1. Start up your computer, and place the bundled CD-ROM into its CD-ROM drive.

- Normally, this should cause the menu screen to appear automatically. If your computer does not display the menu screen automatically, navigate to the CD-ROM on your computer and then double-click the “MENU.exe” file.

2. On the menu screen, click the tab for the language you want.

3. Click the DivX Play Bundle “Read me” file and read its contents.

- “Read me” files contain important information about installation, including installation conditions and computer system requirements.

4. Click “Install” for DivX Play Bundle.

5. Follow the instructions that appear on your computer screen to install DivX Play Bundle.

- This will install DivX Player, the DivX codec, and DivX Web Player.

NOTE

- During the install operation, you will be asked if you want to install the Google Toolbar and Google Desktop. Install these utilities, if you want.

■ Minimum Computer System Requirements for Movie Playback

The minimum system requirements described below are necessary to play back movies recorded with this camera on a Windows computer.

Operating System : Windows XP

Memory : Pentium M, 1GHz or higher
Pentium 4, 2GHz or higher

Required Software : DivX Player (bundled with camera)

IMPORTANT!

- The above is the recommended environment. Configuring this environment does not guarantee proper operation.
- Even if your computer meets the minimum requirements described above, certain settings and other installed software may interfere with proper playback of movies.

Transferring Images to the Camera

In order to return images from your computer memory back to the camera, install Photo Transport on your computer from the CD-ROM that comes with the camera.

■ Installing Photo Transport

1. Start up your computer, and place the bundled CD-ROM into its CD-ROM drive.

- Normally, this should cause the menu screen to appear automatically. If your computer does not display the menu screen automatically, navigate to the CD-ROM on your computer and then double-click the "MENU.exe" file.

2. On the menu screen, click the tab for the language you want.

- Regardless of the language you select, the English version of Photo Transport is installed.

3. Click the Photo Transport “Read me” file and read its contents.

- “Read me” files contain important information about installation, including installation conditions and computer system requirements.

4. Click “Install” for Photo Transport.

5. Follow the instructions that appear on your computer screen to install Photo Transport.

■ Transferring image files to the camera

1. First, connect the camera to your computer.

- See page 217 for information about connecting the camera to your computer.

2. On your computer, click “Start”, “All Programs”, “Casio” and then “Photo Transport”.

This starts up Photo Transport.

3. Drop the image data you want to transfer to the camera onto the Photo Transport Transfer button.

Move your mouse pointer to the image file you want to transfer, and then hold down your mouse button. Keeping your mouse button depressed, drag the mouse pointer and the image file along with it to the Photo Transport Transfer button, and then release the mouse button.

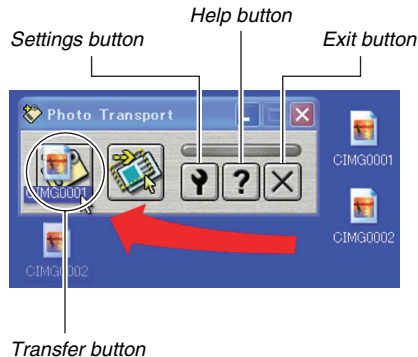

4. Follow the instructions that appear on the display to transfer the image file to the camera.

- The image transfer method and detailed image settings used depend on the Photo Transport settings. For details, see Photo Transport help (page 233).

IMPORTANT!

- You cannot transfer movies to the camera.
- Only image files of the following formats can be transferred to the camera: JPG, JPEG, JPE, and BMP. The transfer operation converts BMP files to JPEG format.

■ Transferring screen captures to the camera

1. First, connect the camera to your computer.

- See page 217 for information about connecting the camera to your computer.

2. On your computer, click “Start”, “All Programs”, “Casio” and then “Photo Transport”.

This starts up Photo Transport.

3. Display the screen whose screen capture you want to transfer.

4. Click the Photo Transport Capture button.

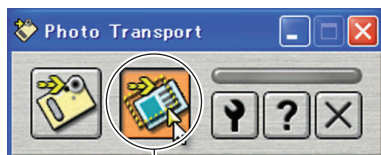

Capture button

5. Use your mouse to select the area of the screen you want to capture.

Move your mouse pointer to the upper left corner of the area you want to capture and then hold down your mouse button. Keeping your mouse button depressed, drag the pointer down to the right corner of the area and then release the mouse button.

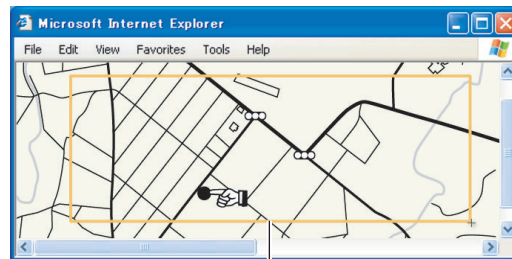

Capture area

6. Follow the instructions that appear on the display to transfer a capture of the selected area to the camera.

- The image transfer method and detailed image settings used depend on the Photo Transport settings. For details, see Photo Transport help (page 233).

IMPORTANT!

- The transfer operation converts screen captures to JPEG format.

■ Photo Transport Setup and Help

Clicking the Settings button will display a dialog box that you can use to configure image transfer settings, to specify the transfer method, etc. For detailed information about the setup, operational procedures, and troubleshooting, click the Help button.

Viewing User Documentation (PDF) Files

1. Start up your computer, and place the bundled CD-ROM into its CD-ROM drive.

- Normally, this should cause the menu screen to appear automatically. If your computer does not display the menu screen automatically, navigate to the CD-ROM on your computer and then double-click the "MENU.exe" file.

2. On the menu screen, click the tab for the language you want.

3. In the "Manual" area, click the name of the manual you want to read.

IMPORTANT!

- You must have Adobe Reader or Adobe Acrobat Reader installed on your computer in order to view the contents of a PDF file. If you do not already have Adobe Reader or Adobe Acrobat Reader installed, install Adobe Reader from the bundled CD-ROM.

User Registration

You can perform user registration over the Internet. To do so, of course, you need to be able to connect to the Internet with your computer.

1. Click the “Register” button.

- This starts up your Web browser and accesses the user registration website. Follow the instructions that appear on your computer screen to register.

Exiting the CD-ROM Menu

On the CD-ROM menu, click “Exit”.

Using the Camera with a Macintosh

Install the required software in accordance with what version of the Macintosh OS you are running and what you want to do.

Objective	OS Version	Install this software:	See page:
<ul style="list-style-type: none">Viewing images on your MacintoshStoring images on your Macintosh	OS 9/OS X	– (USB driver not required.)	236
Transfer of images from the camera and management of images on your Macintosh	OS 9	Photo Loader 1.1	242
	OS X	– <ul style="list-style-type: none">Use iPhoto, which comes bundled with your operating system.	–
Transfer documents to the camera	OS X	CASIO DATA TRANSPORT 1.0	251
View the User's Guide	OS 9/OS X	– <ul style="list-style-type: none">Use Adobe Reader or Adobe Acrobat reader, which comes bundled with your operating system.	243

NOTE

- Printing is not supported with Photo Loader 1.1. Use commercial software for printing on a Macintosh.
- Movies you shoot with your camera cannot be played back on a Macintosh (page 89).

System Requirements

System requirements are different for each of the applications. Be sure to check the requirements for the particular application you are trying to use. Note that the values provided here are minimum requirements for running each application. Actual requirements are greater, depending on the number of images and the sizes of the images being handled.

Photo Loader 1.1

Memory : 32MB

HD : At least 3MB

USB connection is supported on a Macintosh running Mac OS 9 or OS X. Operation is supported using the standard USB driver that comes with the operating system, so all you need to do is connect the camera to your Macintosh using the USB cable.

CASIO DATA TRANSPORT 1.0

OS : OS X 10.2.8 or greater

Other : Sufficient memory to run the operating system

IMPORTANT!

- For details about the minimum system requirements for each software application, see the “readme” files on the CD-ROM that comes bundled with the camera.

Viewing and Storing Images on a Macintosh

You can view and store images (snapshot and movie files) on your Macintosh by connecting to the camera via its USB cradle.

IMPORTANT!

- Connection is not supported to a Macintosh running Mac OS 8.6 or lower, or Mac OS X 10.0. Connection is supported to a Macintosh running Mac OS 9 or OS X (10.1, 10.2, 10.3, 10.4) only. Use the standard USB driver that comes with the operating system for connection.

■ Connecting the Camera to Your Computer the First Time

1. Connect the bundled AC adaptor to the [DC IN 5.3V] connector of the USB cradle and then plug it in to a household power outlet.

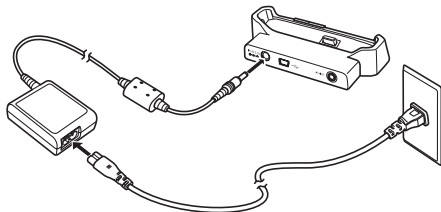

- If you do not plan to use the AC adaptor, make sure that the camera's battery is fully charged.

2. Connect the USB cable that comes bundled with the camera to the USB cradle and the USB port of your Macintosh.

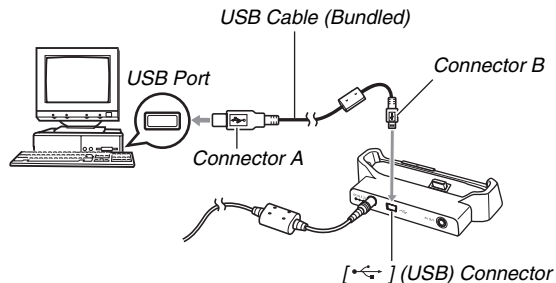

- Orient the USB plug so it correctly matches the shape of the USB port when you connect them.
- Plug the USB cable into the ports securely, as far as it will go. Proper operation is not possible if connections are not correct.

3. Press the camera's [ON/OFF] button to turn it on and then press [MENU].

- Do not place the camera on the USB cradle yet.

4. On the "Set Up" tab, select "USB" and then press [▶].

5. Use [▲] and [▼] to select "Mass Storage" and then press [SET].

6. Press the camera's [ON/OFF] button to turn it off and then place the camera on the USB cradle.

- Do not place the camera onto the USB cradle while it is turned on.
- If you plan to transfer images from the camera's built-in memory to your Macintosh, make sure there is no memory card loaded in the camera.

7. Press the USB cradle's [USB] button.

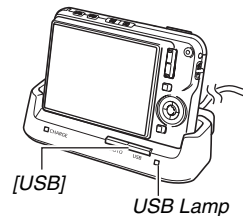

Camera-Macintosh Connection

Pressing the cradle's [USB] button puts it into the USB mode, which is indicated by the USB lamp lighting green. In this mode, your Macintosh recognizes the memory card loaded in the camera (or the camera's built-in memory if it does not have a memory card loaded) as a drive.

The appearance of the drive icon depends on the Mac OS version you are using.

From now on, you will not have to perform steps 3 through 5 in the above procedure when you connect the camera to your Macintosh (unless you change the camera's USB settings for some reason).

IMPORTANT!

- Never disconnect the USB cable or remove the camera from the USB cradle without exiting the USB mode first. Doing so can corrupt image data. See "Removing the Camera from the USB Cradle" on page 242 for the correct steps you need to perform to remove the camera from the cradle safely.

■ Connecting the Camera to Your Macintosh after the First Time

Since you need to configure menu settings only the first time you connect the camera to your Macintosh, later connections are much simpler.

1. Press the camera's [ON/OFF] button to turn it off and then place the camera on the USB cradle.

- Do not place the camera onto the USB cradle while it is turned on.
- If you plan to transfer images from the camera's built-in memory to your Macintosh, make sure there is no memory card loaded in the camera.

2. Press the USB cradle's [USB] button.

- Pressing the cradle's [USB] button puts it into the USB mode, which is indicated by the USB lamp lighting green.

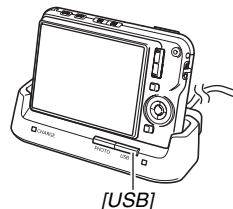

■ Viewing Camera Images on Your Macintosh

After connecting the camera to your Macintosh, you can view camera images on your Macintosh screen.

- For information about connecting to a Macintosh, see “Connecting the Camera to Your Macintosh after the First Time” on page 239.

- 1. Double-click the camera’s drive icon.**
- 2. Double-click the “DCIM” folder.**
- 3. Double-click the folder that contains the image you want to view.**
- 4. Double-click the file that contains the image you want to view.**

This displays the image.

IMPORTANT!

- Do not leave the same image displayed on your Macintosh screen for a long time. Doing so can cause image “burn in”.

NOTE

- An image that was rotated on the camera will be displayed on your Macintosh screen in its original (unrotated) orientation.

■ Saving an Image on Your Macintosh

In order to work on an image to put it into an album, you must first save it to your Macintosh. To save a camera image to your Macintosh, you must first establish a connection between them via the camera's USB cradle.

- For information about connecting to a Macintosh, see "Connecting the Camera to Your Macintosh after the First Time" on page 239.

1. Double-click the camera's drive icon.

2. Drop the "DCIM" folder into the folder where you want to store it.

This copies the "DCIM" folder to the folder on your Macintosh.

IMPORTANT!

- Never use your computer to modify, delete, move, or rename any image files that are in the camera's built-in memory or memory card. Doing so can cause problems with the camera's image management data, which will make it impossible to play back images on the camera and can drastically alter remaining memory capacity. Whenever you want to modify, delete, move, or rename an image, do so only on images that have been copied to your Macintosh.
- Never unplug the USB cable, or operate the camera or cradle while viewing or storing images. Doing so can cause data to become corrupted.

■ Removing the Camera from the USB Cradle

1. On your Macintosh screen, drag the camera drive to Trash.
2. Press the USB cradle [USB] button. After making sure that the cradle's USB lamp is not lit, remove the camera from the cradle.

Transfer of Images from the Camera and Management of Images on Your Macintosh

If you are running Mac OS X, you can manage snapshots using iPhoto, which comes bundled with your operating system.

If you are running Mac OS 9, install the Photo Loader application from the CD-ROM that comes with the camera.

Photo Loader lets you import images from the camera to your Macintosh automatically, to arrange images by recording date, and to display images in a calendar format.

■ Installing Photo Loader

Before starting installation, be sure to read any "readme" file that accompanies Photo Loader. "readme" files contain important information about installation, including installation conditions and computer system requirements.

1. Place the CD-ROM that comes bundled with the camera into your Macintosh CD-ROM drive.
2. Open the folder named "Photo Loader".
3. Open the folder named "English" and then open the folder named "Important".

4. Open the folder named “Installer” and then open the file named “readme”.
5. Follow the instructions in the “readme” file to install Photo Loader.



IMPORTANT!

- See the “readme” file that comes with Photo Loader for information about what you need to do to be able to use existing libraries after updating, re-installing Photo Loader, or moving Photo Loader to another computer. If you do not follow the correct procedure for installation, you may not be able to display existing library information or calendar format HTML files with Photo Loader, or imported image files may be deleted.

Viewing User Documentation (PDF Files)

You must have Adobe Reader or Adobe Acrobat Reader installed on your computer in order to view the contents of a PDF file. If you don't, go to the Adobe Systems Incorporated website and install Acrobat Reader.

■ To view the camera user's guide

1. On the CD-ROM, open the “Manual” folder.
2. Open the “Digital Camera” folder and then open the folder for the language whose user's guide you want to view.
3. Open the file named “camera_xx.pdf”.
 - “xx” is the language code (Example: camera_e.pdf is for English.)

■ Viewing the Photo Loader User's Guide

1. On the CD-ROM, open the "Manual" folder.
2. Open the "Photo Loader" folder and then open the "English" folder.
3. Open "PhotoLoader_english".

Registering as a User

Internet registration only is supported. Visit the following CASIO website to register:

<http://world.casio.com/qv/register/>

Reading Files Directly from a Memory Card

The method you should use to read files from a memory card depends on the type of computer you have. Some typical examples are shown below. After you connect, use the same procedures as those that you use when the camera is connected to your computer via the USB cradle.

■ If your computer has a memory card slot

Insert the camera's memory card directly into the slot.

■ If your computer has a PC card slot

Use a commercially available PC card adapter (for SD memory card, SDHC memory card, MMC, and MMC*plus*) to insert the memory card into the slot. For full details, see the user documentation that comes with the PC card adapter and your computer.

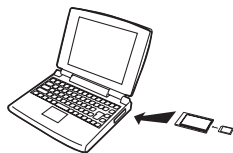

■ Other types of computers

Use either of the method described below.

- Use a commercially available SD memory card/ SDHC memory card reader/ writer. See the user documentation that comes with the SD memory card/ SDHC memory card reader/writer for details about how to use it.
- Use a commercially available PC card reader/writer in combination with a commercially available PC card adapter (for SD memory card, SDHC memory card, MMC, and MMC*plus*). See the user documentation that comes with the PC card reader/writer and PC card adapter for details about how to use them.

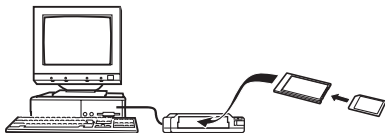
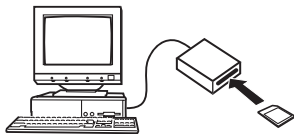

Memory Card Data

The camera stores images you shoot and other data in accordance with the Design Rule for Camera File System (DCF).

■ About DCF

DCF is a system that defines both image file formats and the structure of the folders that store data. This makes it possible for a digital camera, printer, or other DCF-compliant device to display or print image data from another DCF device.

■ Memory Folder Structure

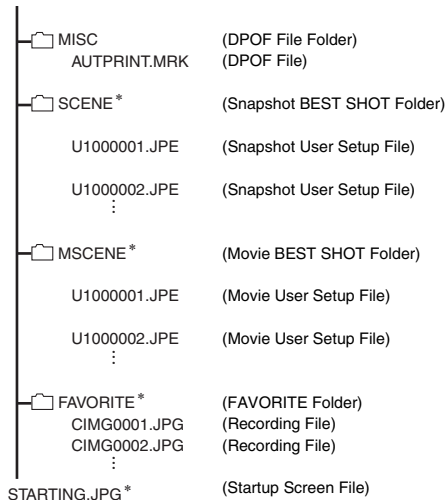
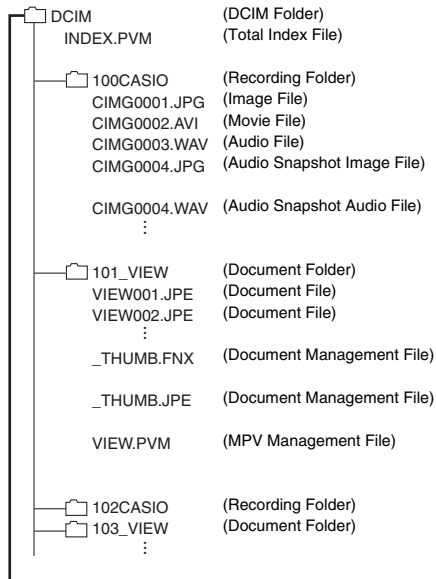

* Indicates files that can be created in built-in memory only.

Folder and File Contents

- DCIM Folder
Folder that contains all of the camera files
 - Total Index File
Management file of the document folder
 - Recording Folder
Folder that contains files recorded with the camera
 - Image File
File of an image shot with the camera. Extension is "JPG".
 - Movie File
File of a movie shot with the camera. Extension is "AVI".
 - Audio File
Audio recording file. Extension is "WAV".
 - Audio Snapshot Image File
Image file of an audio snapshot. Extension is "JPG".
 - Audio Snapshot Audio File
Audio recording file of an audio snapshot. Extension is "WAV".
 - Document Folder
Folder that contains document files transferred to the camera
 - Document File
Document files transferred to the camera
 - Document Management File
Management file for documents transferred to the camera
 - MPV Management File
Management file for documents transferred to the camera
-
- DPOF File Folder
Folder that contains DPOF files, etc.
 - Snapshot BEST SHOT Folder
Folder that contains snapshot BEST SHOT user setup files
 - Snapshot User Setup File
File of a snapshot BEST SHOT user setup
 - Movie BEST SHOT Folder
Folder that contains Movie BEST SHOT user setup files
 - Movie User Setup File
Files that contain Movie BEST SHOT user setups
 - FAVORITE Folder
Folder that contains Favorites image files. Size of images is 320 × 240 pixels.
 - Startup Screen File
File for storing the startup screen image. This file is created when you specify an image for use as the startup screen image.

■ Supported Image Files

- Image files shot with this camera
- DCF-compliant image files

Even if an image is DCF-compliant, this camera still may not be able to display it. When displaying an image recorded on another camera, it may take a long time for the image to appear on this camera's monitor screen.

■ Built-in Memory and Memory Card Data Handling Precautions

- When saving camera data to a computer hard disk, MO disk, or other medium, be sure to transfer the entire DCIM folder and its contents. Changing the name of the DCIM to a date or something similar after you copy it to your computer is a good way to keep track of multiple DCIM folders. When moving the folder back to the camera, however, be sure to change its name back to DCIM. This camera does not recognize any folder name besides DCIM.

All of the other folders inside the DCIM folder must also have their original names if you transfer them back to the camera.

- Folders and files must be stored in accordance with the "Memory Folder Structure" shown on page 246 in order for the camera to be able to recognize them correctly.

TRANSFERRING DOCUMENTS TO YOUR CAMERA (DATA STORAGE)

You can use CASIO DATA TRANSPORT to transfer documents, web page images, and other documents you can view on your computer screen to the camera. Then you can view the documents on the camera's monitor screen.

NOTE

- In this section, anything you transfer to the camera is called a "document". Some documents can contain multiple "pages".



IMPORTANT!

- Just about any document you can print from your computer can be transferred to the camera. Note, however, the ability to properly transfer and display any particular type of document is not guaranteed.
- Certain types of documents may look different on the camera's monitor screen than it looks on your computer screen.

Transferring Documents to the Camera

Transferring documents from a computer running Windows

To transfer documents on your computer to the camera so you can view it on the monitor screen, you need to install CASIO DATA TRANSPORT from the CD-ROM that comes with the camera.

■ Installing CASIO DATA TRANSPORT

1. Start up your computer, and place the bundled CD-ROM into its CD-ROM drive.

- Normally, this should cause the menu screen to appear automatically. If your computer does not display the menu screen automatically, navigate to the CD-ROM on your computer and then double-click the "MENU.exe" file.

- 2. On the menu screen, click the tab for the language you want.**
 - Regardless of the language you select, the English version of CASIO DATA TRANSPORT is installed.
- 3. Click the DATA TRANSPORT “Read me” file and read its contents.**
 - “Read me” files contain important information about installation, including installation conditions and computer system requirements.
- 4. Click “Install” for DATA TRANSPORT.**
- 5. Follow the instructions that appear on your computer screen to install CASIO DATA TRANSPORT.**

■ Transferring documents

- 1. First, connect the camera to your computer.**
 - Before connecting the camera to your computer, make sure that a memory card is loaded in the camera.
 - See page 217 for information about connecting the camera to your computer.
- 2. On your computer, open the document data file that you want to transfer to the camera.**
- 3. On the application menu of the currently open document, select “Print”. On the print dialog box that appears, select “CASIO DATA TRANSPORT” for the “Printer Name” setting.**

4. Click the [OK] button.

This will display a dialog box for customizing document file properties (date, file name, icon).

5. Check the current data settings (date, file name, icon) and then click the [OK] button.

This will convert the document data to a JPEG image and transfer the image to the camera.

- You can change the date, filename, and icon settings if you want.
- To cancel the transfer, click the [Cancel] button.
- If you want a document image be displayed on the camera's monitor screen using an orientation that is different from that used on the computer screen, click the [Properties] button on the print dialog box, change the "Orientation" setting, and then click the [OK] button.

Transferring documents from a Macintosh

To transfer documents on your computer to the camera so you can view it on the monitor screen, you need to install CASIO DATA TRANSPORT from the CD-ROM that comes with the camera.

■ Installing CASIO DATA TRANSPORT

Before starting installation, be sure to read any "readme" file that accompanies CASIO DATA TRANSPORT. "readme" files contain important information about installation, including installation conditions and computer system requirements.

- 1. Place the CD-ROM that comes bundled with the camera into your Macintosh CD-ROM drive.**
- 2. Open the folder named "DATA TRANSPORT".**

3. Double-click “TRANSPORT_Installer”.
4. Follow the instructions in the “readme” file to install CASIO DATA TRANSPORT.

■ Transferring documents

1. **First, connect the camera to your Macintosh.**
 - Before connecting the camera to your Macintosh, make sure that a memory card is loaded in the camera.
 - See page 237 for information about connecting the camera to your Macintosh.
2. **On your Macintosh, open the document that you want to transfer to the camera.**
3. **On the menu bar, click “File” and then “Print”.**
4. **Click the PDF button at the bottom of the dialog box and then select “CASIO DATA TRANSPORT” from the menu that appears.**

This will display a dialog box for customizing document file properties (date, file name, icon).

5. Check the current data settings (date, file name, icon) and then click the [OK] button.

This will convert the document to a JPEG image and transfer the image to the camera.



- You can change the date, filename, and icon settings if you want.
- To cancel the transfer, click the [Cancel] button.

Viewing a Transferred Document on the Camera

1. On the camera, select either the REC mode or the PLAY mode.

2. Press [DATA].

This enters the data mode and displays a menu of documents currently in camera memory.

- The currently selected document is the one with the red boundary around it.
- Pressing [DATA] will return to the screen that was displayed before you entered the data mode.
- Pressing [] enters the REC mode, while pressing [] enters the PLAY mode.

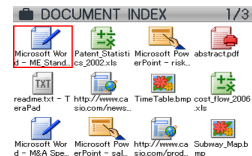

3. Use [▲], [▼], [◀], and [▶] to move the boundary to the document you want to select.

- The document menu screen can show up to 12 documents. If there are more than 12 documents in camera memory, use [▲] or [▼] to switch between the menu screens of 12 images each.

4. Press [SET] to open the currently selected document and display its pages (contents).



5. Use [▶] (forward) and [◀] (back) to scroll through the pages of the document.

- Pressing [▲] jumps to page 1 of the document.

NOTE

- Pressing [SET] or the zoom button toggles between the document menu and the document page screens.
- Pressing [DISP] while the document page screen is on the display will display a menu screen for configuring screen settings. You can use the menu to turn display information on or off.

IMPORTANT!

- Note that selecting “All Images” for printing will also print all the pages of all the documents that have been transferred to the camera. Regardless of whether you are printing at home or if you are using an outside printing service, make sure you know what is stored in a memory card (especially documents) before selecting “All Images” (page 207).

Specifying the Initial Data Mode Screen

You can use the following procedure to configure the camera so either the document data list or the last document page you were viewing appears first whenever you press [DATA] to enter the data mode.

1. Press [MENU].
2. On the “Set Up” tab, select “DATA View”, and then press [▶].
3. Use [▲] and [▼] to select the setting you want, and then press [SET].

To have this screen appear first:	Select this setting:
Document menu	List View
Document page you were viewing when you last exited the data mode	Page View

Deleting Documents from Camera Memory

Deleting a Document Page

After displaying a document page, you can delete a single document page or all the pages in a document at the same time.

■ To delete a single document page

1. Display a page in the document that contains the page you want to delete and then press [▼] (⏮ ).
2. Use [◀] and [▶] to select the document page you want to delete.
3. Use [▲] and [▼] to select “1 page” and then press [SET].
4. To delete other document pages, repeat steps 2 and 3.
 - To exit the delete operation, press [MENU].

■ To delete all the pages in a document page

1. Display a page in the document whose pages you want to delete and then press [▼] (⏏).
2. Use [▲] and [▼] to select “All pages” and then press [SET].
3. Use [▲] and [▼] to select “Yes”.
 - To cancel the delete operation, select “No” instead of “Yes”.
4. Press [SET].

Deleting Documents

You can use the document menu to select a specific document and delete it, or you can delete all documents currently in camera memory.

■ To delete a single document

1. On the document menu, use [▲], [▼], [◀], and [▶] to move the selection boundary to the document you want to delete.
2. Press [MENU].
3. Use [▲] and [▼] to select “1 doc” and then press [SET].
4. Use [▲] and [▼] to select “Yes”.
 - To cancel the delete operation, select “No” instead of “Yes”.
5. Press [SET].

■ To delete all documents

1. While the document menu is displayed, press [MENU].
2. Use [▲] and [▼] to select “All docs” and then press [SET].
3. Use [▲] and [▼] to select “Yes”.
 - To cancel the delete operation, select “No” instead of “Yes”.

4. Press [SET].

This will delete all documents in camera memory and display the message “No documents in memory. Exiting data mode.”.

NOTE

- Formatting camera memory (pages 50, 199) will also delete all documents currently in camera memory.

APPENDIX

General Guide

The numbers in parentheses indicate the pages where each part is explained.

■ Camera

Front

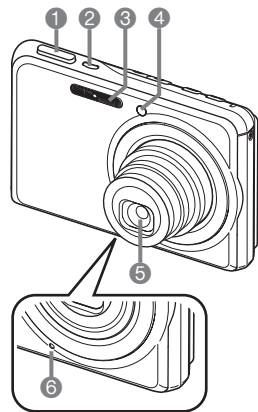

- 1 Shutter (page 65)
- 2 [ON/OFF] (Power) (page 43)
- 3 Flash (page 76)
- 4 AF Assist/Self-timer Lamp (pages 63, 70, 81, 267)
- 5 Lens
- 6 Microphone (pages 91, 175)

Back

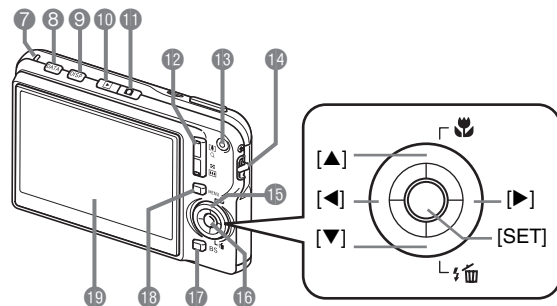

- 7 Operation Lamp (pages 43, 65, 267)
- 8 [DATA] Button (page 253)
- 9 [DISP] Button (page 53)
- 10 [▶] (PLAY) Button (pages 43, 197)
- 11 [📷] (REC) Button (pages 43, 197)
- 12 Zoom Button (pages 72, 154, 155)
- 13 [●] (Movie) Button (page 89)
- 14 Strap Hole (page 2)
- 15 Control Button ([▲], [▼], [◀], [▶])
- 16 [SET] Button
- 17 [BS] Button (page 98)
- 18 [MENU] Button (page 52)
- 19 Monitor Screen (page 53)

Bottom

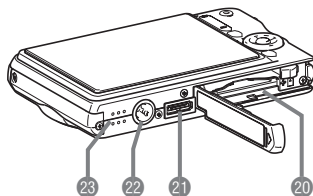

- 20 Battery/Memory Card Slots (pages 37, 48)
- 21 Cradle Contact (page 39)
- 22 Tripod Hole
Use this hole when attaching to a tripod.
- 23 Speaker (page 143)

■ USB Cradle

Front

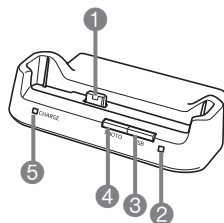

- 1 Camera Contact (page 39)
- 2 USB Lamp
(pages 219, 238, 270)
- 3 [USB] Button
(pages 205, 219, 238)
- 4 [PHOTO] Button
(pages 150, 151)
- 5 [CHARGE] Lamp
(pages 39, 270)

Back

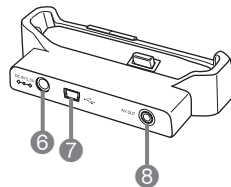

- 6 [DC IN 5.3V] (External Power)
Terminal (page 38)
- 7 [USB] Connector
(pages 203, 218, 237)
- 8 [AV OUT] (AV output port)
(page 151)

Monitor Screen Contents

The monitor screen uses various indicators, icons, and values to keep you informed of the camera's status.

- The sample screens in this section are intended to show you the locations of all the indicators and figures that can appear on the monitor screen in various modes. They do not represent screens that actually appear on the camera.

■ Recording Mode

Normal

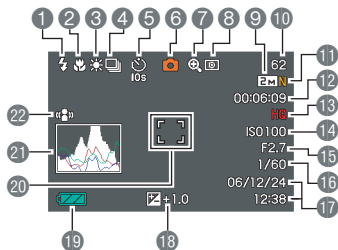

Panel (Operation Panel)

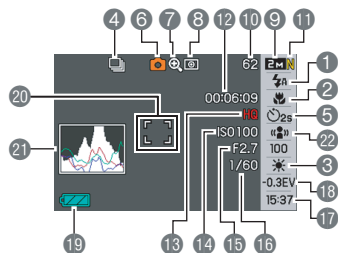

- 1 Flash Mode (page 76)
- 2 Focus Mode (page 112)
- 3 White Balance Setting (page 123)
- 4 Continuous Shutter Mode (page 83)
- 5 Self-timer Mode (page 81)
- 6 Recording Mode
- 7 Digital zoom indicator (page 74)
- 8 Metering Mode (page 127)
- 9 Snapshot Image Size (page 67)
- 10 Remaining Snapshot Memory Capacity (page 278)
- 11 Snapshot Image Quality (page 69)
- 12 Remaining Movie Memory Capacity (page 90)
- 13 Movie Image Quality (page 89)
- 14 ISO Sensitivity (page 126)
- 15 Aperture Value (page 66)
- 16 Shutter Speed (page 66)
- 17 Date/Time (page 192)
- 18 Exposure Compensation (page 121)
- 19 Battery Level Indicator (page 41)
- 20 Focus Frame (pages 64, 116)
- 21 Histogram (page 132)
- 22 Anti Shake Indicator (page 104)

★ IMPORTANT!

- The aperture value, shutter speed, and ISO sensitivity will all turn orange if any one of them is not correct when the shutter button is half-pressed.

■ Snapshot Playback Mode

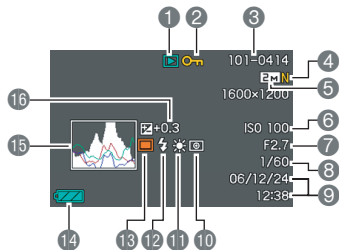

- ① File Type (page 142)
- ② Protect Indicator (page 180)
- ③ Folder Name/File Name (page 179)
- ④ Snapshot Image Quality (page 69)
- ⑤ Snapshot Image Size (page 67)
- ⑥ ISO Sensitivity (page 126)
- ⑦ Aperture Value (page 66)
- ⑧ Shutter Speed (page 66)
- ⑨ Date/Time (page 192)
- ⑩ Metering Mode (page 127)
- ⑪ White Balance Setting (page 123)
- ⑫ Flash Mode (page 76)
- ⑬ Recording Mode (page 41)
- ⑭ Battery Level Indicator (page 41)
- ⑮ Histogram (page 132)
- ⑯ Exposure Compensation (page 121)

■ Movie Playback Mode

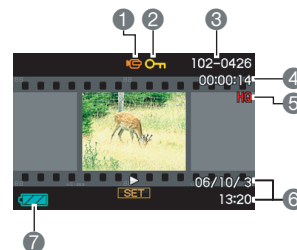

- ① File Type (page 144)
- ② Protect Indicator (page 180)
- ③ Folder Name/File Name (page 179)
- ④ Movie Recording Time (page 144)
- ⑤ Movie Image Quality (page 89)
- ⑥ Date/Time (page 192)
- ⑦ Battery Level Indicator (page 41)

Icon Help

Icon Help provides you instant access to information about the icons that appear on the monitor screen in the REC mode. You can turn off icon help if you want (page 137).

- Icon Help text is displayed for the following functions.
Recording mode, Focus mode, Flash Mode, Metering, White Balance, Self-timer, EV Shift
- Metering, White balance, self-timer, and EV shift icon help text appears only when “Metering”, “White Balance”, “Self-timer”, or “EV Shift” is assigned to the [◀] and [▶] keys with the key customization feature (page 135).



Menu Reference

The tables in this section show the items that appears on the menus that appear on the monitor screen when you press [MENU]. The items included on the menus depend on whether the camera is in the REC mode or PLAY mode.

- An asterisk (*) indicates reset default settings.









■ REC Mode

REC Tab Menu

Continuous	Normal Speed / High Speed / Flash Cont. / Zoom Cont. / Off*
Self-timer	10 sec / 2 sec / X3 / Off*
Anti Shake	Auto / Off*
AF Area	 Spot* /  Multi
AF Assist Light	On* / Off
Digital Zoom	On* / Off
L/R Key	Metering / EV Shift / White Balance / ISO / Self-timer / Off*
Quick Shutter	On* / Off
Audio Snap	On / Off*
Grid	On / Off*
Review	On* / Off



Icon Help	On* / Off
Memory	 BEST SHOT: On / Off* Flash: On* / Off Focus: On / Off* White Balance: On / Off* ISO: On / Off* AF Area: On* / Off Metering: On / Off* Self-timer: On / Off* Flash Intensity: On / Off* Digital Zoom: On* / Off MF Position: On / Off* Zoom Position: On / Off*

Quality Tab Menu

Size	7M (3072 × 2304)* / 3:2 (3072 × 2048) / 16:9 (3072 × 1728) / 5M (2560 × 1920) / 3M (2048 × 1536) / 2M (1600 × 1200) / VGA (640 × 480)
Quality (Snapshots)	Fine / Normal* / Economy
Quality (Movies)	HQ* / HQ Wide / Normal / Normal Wide / LP
EV Shift	-2.0 / -1.7 / -1.3 / -1.0 / -0.7 / -0.3 / 0.0* / +0.3 / +0.7 / +1.0 / +1.3 / +1.7 / +2.0
White Balance	Auto* /  (Daylight) /  (Overcast) /  (Shade) /  N (Day White Fluorescent) /  D (Daylight Fluorescent) /  (Tungsten) / Manual
ISO	Auto* / ISO 50 / ISO 100 / ISO 200 / ISO 400
Metering	 Multi* /  Center weighted /  Spot
Filter	Off* / B/W / Sepia / Red / Green / Blue / Yellow / Pink / Purple
Sharpness	+2 / +1 / 0* / -1 / -2





Saturation	+2 / +1 / 0* / -1 / -2
Contrast	+2 / +1 / 0* / -1 / -2
Flash Intensity	+2 / +1 / 0* / -1 / -2
Flash Assist	Auto* / Off

Set Up Tab Menu

Sounds	Startup* / Half Shutter / Shutter / Operation /  Operation /  Play
Startup	On (Selectable image) / Off*
File No.	Continue* / Reset
World Time	Home* / World
	Home Time setup (city, DST, etc.)
	World Time setup (city, DST, etc.)
Timestamp	Date / Date&Time / Off*
Adjust	Time setting
Date Style	YY/MM/DD / DD/MM/YY / MM/DD/YY
Language	Changes the screen text language. <ul style="list-style-type: none"> The number and types of languages depend on the geographic area where the camera was marketed.
DATA View	Page View / List View
Sleep	30 sec / 1 min* / 2 min / Off
Auto Power Off	2 min* / 5 min
REC / PLAY	Power On* / Power On/Off / Disable
USB	Mass Storage* / PTP (PictBridge)
Video Out	NTSC 4:3* / NTSC 16:9 / PAL 4:3 / PAL 16:9
Format	Format / Cancel*
Reset	Reset / Cancel*

■ PLAY Mode

PLAY Tab Menu

Slideshow	Start* / Images / Time / Interval / Effect / Cancel
MOTION PRINT	9 frames* / 1 frame / Cancel
 Anti Shake	On / Off*
Movie Editing	 Cut (Before) /  Cut (Between) /  Cut (After) / Cancel*
Keystone	–
Color Correction	–
Calendar	–
Favorites	Show* / Save / Cancel
DPOF Printing	Select images* / All images / Cancel
Protect	On* / All Files : On / Cancel
Date/Time	–
Rotation	Rotate* / Cancel
Resize	5M (2560 × 1920) / 3M (2048 × 1536)* / VGA (640 × 480) / Cancel
Trimming	–
Dubbing	–
Copy	Built-in → Card* / Card → Built-in / Cancel

“Set Up” Tab

- The contents of the “Set Up” tab are the same in the REC mode and PLAY mode.

Display Menu Reference

The tables in this section show the items that appears on the menus that appear on the monitor screen when you press [DISP]. Most of these items are for configuring monitor screen settings. The items included on the menus depend on whether the camera is in the REC mode or PLAY mode.

- An asterisk (*) indicates reset default settings.

■ REC Mode

Layout	Panel (Operation Panel)* / Normal
Info.	Show* / +Histogram / Hide
Brightness	Auto / +2 / +1 / 0 / -1
Type	Dynamic* / Vivid / Real / Night / Power Saving

■ PLAY Mode

Layout	Normal / Wide*
Info.	Same as REC Mode settings.
Brightness	Same as REC Mode settings.
Type	Same as REC Mode settings.

Indicator Lamps

The camera has lamps: an Operation Lamp and an AF assist/self-timer Lamp. These lamps light and flash to indicate the current operational status of the camera.

Operation Lamp

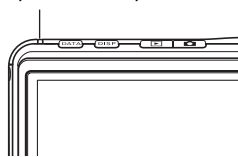

AF assist/self-timer Lamp

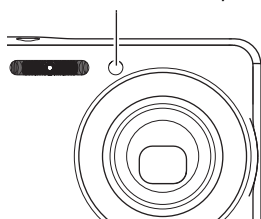

* There are three lamp flash patterns. Pattern 1 flashes once per second, Pattern 2 flashes twice per second, and Pattern 3 flashes four times per second. The table below explains what each flash pattern indicates.

REC Mode

Operation Lamp			AF Assist/ Self-timer Lamp	Meaning
Green	Red	Amber	Red	
Lit				Operational (Power on, recording enabled)
		Pattern 3		Flash is charging.
	Lit			Flash charging is complete.
Lit				Auto Focus operation was successful.
Pattern 3				Cannot Auto Focus.
Lit				LCD is off or in sleep state.
Pattern 2				Image is being stored.
Pattern 1				Storing movie or processing image.
			Pattern 1	Self-timer countdown (10 - 3)
			Pattern 2	Self-timer countdown (3 - 0)

Operation Lamp			AF Assist/ Self-timer Lamp	Meaning
Green	Red	Amber	Red	
	Pattern 1			Cannot charge flash.
	Pattern 2			Memory card problem / Memory card is unformatted. / BEST SHOT setup cannot be registered.
	Lit			Memory card is locked / Cannot create folder. / Memory is full. / Write error
	Pattern 3			Low battery alert
Pattern 3				Card is being formatted.
Pattern 3				Powering down

IMPORTANT!

- Never remove the memory card from the camera while the operation lamp is flashing green. Doing so will cause the image you shot to be lost.

■ PLAY mode

Operation Lamp			AF Assist/ Self-timer Lamp	Meaning
Green	Red	Amber	Red	
Lit				Operational (Power on, recording enabled)
Pattern 3				One of the following operations is in progress: Delete, DPOF, protect, copy, format, resize, trimming, adding audio to snapshot, keystone correction, color correction, MOTION PRINT, movie editing, power down
	Pattern 2			Memory card problem / Memory card is unformatted.

Operation Lamp			AF Assist/ Self-timer Lamp	Meaning
Green	Red	Amber	Red	
	Lit			Memory card is locked / Cannot create folder. / Memory is full.
	Pattern 3			Low battery alert

■ USB Cradle Indicator Lamps

The USB cradle has two indicator lamps: a [CHARGE] lamp and a USB lamp. These lamps light and flash to indicate the current operational status of the cradle and camera.

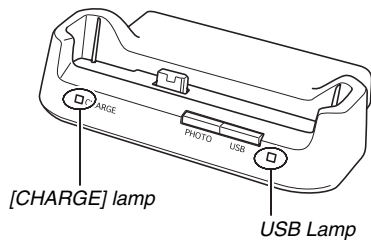









[CHARGE] Lamp		USB Lamp		Meaning
Color	Status	Color	Status	
Red	Lit			Charging
Green	Lit			Charging complete
Amber	Lit			Charge standby
Red	Flashing			Charge error
		Green	Lit	USB connection
		Green	Flashing	Memory being accessed.

Troubleshooting Guide

Find the Problem and Fixing It

Problem	Possible Causes	Action
Power Supply		
Power does not turn on.	<ol style="list-style-type: none">1) The battery is not oriented correctly.2) The battery is dead.	<ol style="list-style-type: none">1) Orient the battery correctly (page 37).2) Charge the battery (page 37). If the battery goes dead soon after being charged, it means the battery has reached the end of its life and needs to be replaced. Purchase a separately available NP-20 rechargeable lithium ion battery.
Camera suddenly powers down.	<ol style="list-style-type: none">1) Auto Power Off activated (page 45).2) The battery is dead.	<ol style="list-style-type: none">1) Turn power back on.2) Charge the battery (page 37).
Image Recording		
Image is not recorded when the shutter button is pressed.	<ol style="list-style-type: none">1) Camera is in the PLAY mode.2) Flash is charging.3) Memory is full.	<ol style="list-style-type: none">1) Press [] (REC) to enter the REC mode.2) Wait until the flash finishes charging.3) Transfer images your computer, delete images you no longer need, or use a different memory card.
Auto Focus does not focus properly	<ol style="list-style-type: none">1) The lens is dirty.2) The subject is not in the center of the focus frame when you compose the image.3) The subject you are shooting is a type that is not compatible with Auto Focus.4) You are moving the camera when shooting.5) You are pressing the shutter button all the way without half-pressing.	<ol style="list-style-type: none">1) Clean the lens.2) Make sure the subject is centered in the focus frame when composing the image.3) Use manual focus (page 119).4) Mount the camera on a tripod.5) Half-press the shutter button and allow enough time for Auto Focus to focus.

Problem	Possible Causes	Action
The subject is out of focus in the recorded image.	The image is not focused properly.	When composing the image, make sure the subject is located inside the focus frame.
The flash does not fire.	<ol style="list-style-type: none"> 1)  (Flash Off) is selected as the flash mode. 2) The battery is dead. 3) A BEST SHOT scene that selects  (Flash Off) as the flash mode is selected. 	<ol style="list-style-type: none"> 1) Select a different flash mode (page 76). 2) Charge the battery (page 37). 3) Turn on the flash (page 76) or select a different BEST SHOT scene (page 98).
Camera powers down during self-timer countdown.	The battery is dead.	Charge the battery (page 37).
The monitor screen image is out of focus.	<ol style="list-style-type: none"> 1) You are using the Manual Focus and have not focused the image. 2) You are trying to use the Macro Focus () when shooting a scenery or portrait shot. 3) You are trying to use Auto Focus or Infinity Focus () when shooting a close-up shot. 	<ol style="list-style-type: none"> 1) Focus the image (page 119). 2) Use Auto Focus for scenery and portrait shots. 3) Use the Macro Focus () for close-ups.
An image I shot was not saved.	<ol style="list-style-type: none"> 1) Power was cut off to the camera before the save operation was complete. 2) The camera's memory card was removed before the save operation was complete. 	<ol style="list-style-type: none"> 1) When the battery indicator shows "", charge the battery as soon as possible (page 37). 2) Do not remove the memory card before the save operation is complete.
Though available lighting is bright, the faces of people in the image are dark.	Not enough light is reaching the subjects.	<ul style="list-style-type: none"> • Change the flash mode setting to "" (Flash On) for daylight synchro flash (page 76). • Increase the EV shift value (page 121).
Subjects are too bright when shooting images in a seashore or ski area.	Sunlight reflected by water, sand, or snow, can cause underexposure of images.	<ul style="list-style-type: none"> • Change the flash mode setting to "" (Flash On) for daylight synchro flash (page 76). • Increase the EV shift value (page 121).

Problem	Possible Causes	Action
Digital zoom does not work. The zoom bar indicates zoom only up to a zoom factor of 3.0.	1) The digital zoom setting is turned off. 2) Date stamping is turned on.	1) Turn on the digital zoom setting (page 75). 2) Turn off date stamping (page 131). Digital zoom is disabled while date stamping is turned on.
Movies		
There is a vertical line on the monitor screen	Shooting a very brightly lit subject can cause a vertical band to appear in the monitor screen image.	This is a CCD phenomenon known as “vertical smear”, and does not indicate malfunction of the camera. Note that vertical smear is not recorded with the image in the case of a snapshot, but it is recorded in the case of a movie.
Images are out of focus.	The subject is outside the range of the camera.	Shoot within the allowable range.
There is digital noise in images.	Sensitivity is increased automatically for dark subjects, which increases the chance of digital noise.	Use a light or some other means to illuminate the subject.
Playback		
Cannot play a movie recorded with this camera on my computer.	You are trying to play back a movie file on a Macintosh.	The Macintosh does not support movie playback using the DivX Play Bundle. Use a Windows computer for playback.
The color of the playback image is different from what appears on the monitor screen when shooting.	Sunlight or light from another source is shining directly into the lens when shooting.	Position the camera so sunlight does not shine directly into the lens.
Images are not displayed.	A memory card with non-DCF images recorded with another camera is loaded in the camera.	This camera cannot display non-DCF images.

Problem	Possible Causes	Action
All buttons and switches are disabled.	Circuit problem caused by electrostatic charge, impact, etc. while the camera was connected to another device.	Remove the battery from the camera, reinsert it, and then try again.
The camera's monitor screen is blank.	USB communication is in progress.	After confirming that the computer is not accessing the memory card, disconnect the USB cable.
Other		
I can't transfer images over a USB connection.	<ol style="list-style-type: none"> 1) The camera is not set securely on the USB cradle. 2) The USB cable is not connected securely. 3) The USB driver is not installed. 4) The camera is turned off. 	<ol style="list-style-type: none"> 1) Check the connection between the camera and USB cradle. 2) Check all connections. 3) Install the USB driver (page 216). 4) Press the USB cradle's [USB] button.
Display language setting screen appears when the camera is turned on.	<ol style="list-style-type: none"> 1) Camera's display language, Home city, date style, date and time, and other settings have not been configured. 2) A problem with the camera's built-in memory management area. 	<ol style="list-style-type: none"> 1) Check the settings (pages 12, 193). 2) Perform the reset operation to initialize the camera's setup (page 139). After that, configure each setting. If the language selection screen does not re-appear when you turn the camera on, it means that the camera's built-in memory management area has been restored. If the same message appears after you turn power back on, contact your retailer or a CASIO service center.

If you have problems installing the USB driver...

You may not be able to install the USB driver properly if you use the USB cable to connect the camera to a computer running Windows 98SE/98 before installing the USB driver from the bundled CD-ROM, or if you have another type of driver installed.

This will make it impossible for the computer to recognize the camera when it is connected. If this happens, you will need to re-install the camera's USB driver.

For information about how to re-install the USB driver, see the USB driver's "Read me" file on the CD-ROM that comes bundled with the camera.

Display Messages

Battery is low.	Battery power is low.
Cannot correct image!	Keystone correction of the image cannot be performed for some reason. The image will be stored as-is, without correction (page 106).
Cannot find the file.	The image you specified with the slideshow "Images" setting cannot be found. Change the "Images" setting (page 147) and try again.
Cannot register any more files.	<ul style="list-style-type: none"> You are attempting to save a BEST SHOT scene when there are already 999 scenes in the "SCENE" folder (page 102). You are attempting to copy a FAVORITE file when the "FAVORITE" folder already contains 9999 files (page 181).
Card ERROR	<p>There is something wrong with the memory card. Turn off the camera, remove the memory card, and then reload it into the camera. If this message re-appears when you turn the camera back on, format the memory card (page 50).</p> <p> IMPORTANT!</p> <ul style="list-style-type: none"> Formatting the memory card deletes all its files. Before formatting, try transferring recoverable files to a computer or some other storage device.

Check connections!	<ul style="list-style-type: none"> You are attempting to connect the camera to a printer while the camera's USB settings are not compatible with the USB system of the printer (page 202). You are attempting to connect to a computer that does not have a USB driver installed (page 216).
Files could not be saved because battery is low.	Battery power is low, so an image file could not be saved.
Folder cannot be created.	You are trying to record a file while there are already 9,999 files stored in the 999th folder. If you want to record more, delete files you no longer need (page 186).
LENS ERROR	This message appears and the camera turns off whenever lens performs some unexpected operation. If the same message appears after you turn power back on, contact your retailer or a CASIO service center.
Load paper!	The printer ran out of paper while printing.
Memory Full	Memory is full. If you want to record more, delete files you no longer need (page 186).
No Favorites file!	The FAVORITE folder does not contain any files.
Printing Error	<p>An error occurred while printing.</p> <ul style="list-style-type: none"> The printer is turned off. The printer generated an error, etc.

Record Error	Image compression could not be performed for some reason during image data storage. Shoot the image again.
Replenish ink!	During printing, the printer is running low on ink or is out of ink.
RETRY POWER ON	If the lens comes into contact with some obstacle, this message appears and the camera turns off. Take action to remove the obstacle, and try turning on power again.
SYSTEM ERROR	Your camera system is corrupted. Contact your retailer or an authorized CASIO service center.
The card is locked.	The LOCK switch of the SD memory card or SDHC memory card loaded in the camera is in the locked position. You cannot store images to or delete images from a memory card that is locked.
There are no files.	There are no files in built-in memory or on the memory card.
There are no printing images. Set up DPOF.	There are currently no files specified for printing. Configure the required DPOF settings (page 205).
There is no image to register.	The setup you are trying to save is for an image that cannot be saved as a user BEST SHOT scene.
This card is not formatted.	The memory card loaded in the camera is not formatted. Format the memory card (page 50).

This file cannot be played.	The file you are trying to access is corrupted or is a type that cannot be displayed by this camera.
This function cannot be used.	You attempted to copy images from built-in memory to a memory card while there is no memory card loaded in the camera (page 184).
This function is not supported for this file.	The function you are trying to use cannot be performed for some reason.

Specifications

■ Main Specifications

Product Type Digital Camera

Model EX-S770D

■ Camera Functions

Image Files

Format Snapshots:
JPEG (Exif Version 2.2); DCF (Design Rule for Camera File System) 1.0 standard; DPOF compliant
Movies: MPEG-4 AVI format, DivX
Audio: WAV

Recording Media Built-in Memory 6.0 MB
SDHC Memory Card
SD Memory Card
MMC (MultiMediaCard)
MMC*plus* (MultiMediaCard*plus*)

Storage Capacity

- Snapshots

Image Size (Pixels)	Image Quality	Approximate Image File Size	Approximate Built-in Memory (6.0MB) Capacity	Approximate SD Memory Card* (256MB) Capacity
7M (3072 × 2304)	Fine	4.32 MB	1 image	55 images
	Normal	2.1 MB	2 images	110 images
	Economy	1.44 MB	3 images	158 images
3:2 (3072 × 2048)	Fine	3.84 MB	1 image	61 images
	Normal	2.0 MB	2 images	116 images
	Economy	1.28 MB	4 images	176 images
16:9 (3072 × 1728)	Fine	3.24 MB	1 image	73 images
	Normal	1.9 MB	2 images	121 images
	Economy	1.08 MB	5 images	206 images
5M (2560 × 1920)	Fine	3.0 MB	1 image	78 images
	Normal	1.8 MB	3 images	128 images
	Economy	1.0 MB	5 images	221 images
3M (2048 × 1536)	Fine	1.92 MB	2 images	121 images
	Normal	1.28 MB	4 images	180 images
	Economy	640 KB	8 images	348 images

Image Size (Pixels)	Image Quality	Approximate Image File Size	Approximate Built-in Memory (6.0MB) Capacity	Approximate SD Memory Card* (256MB) Capacity
2M (1600 × 1200)	Fine	1.17 MB	4 images	196 images
	Normal	780 KB	7 images	286 images
	Economy	390 KB	12 images	530 images
VGA (640 × 480) (VGA)	Fine	360 KB	15 images	625 images
	Normal	240 KB	22 images	937 images
	Economy	120 KB	40 images	1739 images

- Movies

Image Quality (Pixels)	Maximum Recording Time Per File	Approximate Data Rate (Frame Rate)	Approximate Built-in Memory (6.0MB) Capacity	Approximate SD Memory Card* (256MB) Capacity
HQ 640 × 480	Until memory full	4.0 Megabits/second (30 frames/second)	8 seconds	8 minutes, 17 seconds
HQ Wide 704 × 384	Until memory full	4.0 Megabits/second (30 frames/second)	8 seconds	8 minutes, 17 seconds
Normal 640 × 480	Until memory full	2.1 Megabits/second (30 frames/second)	15 seconds	15 minutes, 44 seconds
Normal Wide 704 × 384	Until memory full	2.1 Megabits/second (30 frames/second)	15 seconds	15 minutes, 44 seconds
LP 320 × 240	Until memory full	745 Kilobits/second (15 frames/second)	42 seconds	43 minutes, 54 seconds

- * Number of image values are approximate and are provided for reference only.
- * Based on Matsushita Electric Industrial Co., Ltd. products.
The number of images you can save depends on the type of memory card you are using.
- * When using a memory card with a different capacity, calculate the number of images as a percentage of 256 MB.

Delete	1 file; all files (with memory protection feature)
Effective Pixels	7.2 million
Imaging Element	1/2.5 square pixel primary color CCD (Total pixels: 7.41 million)
Lens/Focal Distance	F2.7 to 5.2/f=6.2 to 18.6 mm (Equivalent to 38 to 114 mm on a 35 mm film camera.) Six lenses in five groups, including aspherical lens.
Zoom	3X optical zoom / 4X digital zoom (Image Size: 7M (3072 × 2304 pixels)) (12X total zoom)
Focusing	Contrast Detection Auto Focus Focus Modes: Auto Focus, Macro Focus, Pan Focus, Infinity Mode, Manual Focus AF Area: Spot or Multi; with AF assist lamp
Approximate Focus Range	(from lens surface) Auto Focus: 40 cm to ∞ (1.3' to ∞) Macro Focus: 15 cm to 50 cm (5.9" to 19.7") Infinity: ∞ Manual Focus: 15 cm to ∞ (5.9" to ∞) Range is affected by optical zoom.

Exposure Control Metering:
 Multi-pattern, center weighted, and spot
 by imaging element
 Exposure: Program AE
 Exposure Compensation:
 -2EV to +2EV (in 1/3EV steps)

Shutter CCD shutter, mechanical shutter
 Snapshot (Auto):
 1/2 to 1/2000 second
 Snapshot (Night Scene):
 4 to 1/2000 second
 Snapshot (Fireworks): 2 seconds (fixed)

Aperture Value F2.7/4.3 auto switching
 * Using optical zoom causes the aperture
 value to change.

White Balance Auto, fixed (6 modes), manual

Sensitivity Snapshots (Standard):
 Auto, ISO 50, ISO 100, ISO 200, ISO 400
 • Maximum sensitivity is ISO 800 when
 the BEST SHOT Anti Shake or High
 Sensitivity scene is being used.
 Movies: Auto

Self-timer Trigger Times:
 10 seconds, 2 seconds, Triple Self-timer

Built-in Flash Flash Modes:
 Auto, Off, On, Soft Flash, Red-eye
 reduction
 Approximate Flash Range:
 Flash Range:
 Wide Angle Optical Zoom:
 0.15 to 3.9 meters (0.5' to 12.8')
 Telephoto Optical Zoom:
 0.4 to 2.0 meters (1.3' to 6.6')
 • Flash Continuous Shutter
 Wide Angle Optical Zoom:
 0.26 to 1.68 meters (0.9' to 5.5')
 Telephoto Optical Zoom:
 0.4 to 0.87 meters (1.3' to 2.9')
 * ISO Sensitivity: "Auto"
 * Depends on zoom factor.

Recording Snapshots (with audio); Macro; Self-
 timer; Continuous Shutter; BEST SHOT
 (scenes other than Short Movie, Past
 Movie, and Voice Recording); movie with
 audio (Movie, Short Movie, Past Movie);
 audio (Voice Recording)
 * Audio is monaural.

Approximate Audio Recording Times
 Audio Snapshot:
 30 seconds per image
 After Recording:
 30 seconds per image
 Voice Recording:
 18 minutes (when using built-in memory)

Monitor Screen.2.8-inch Wide TFT color LCD 230,400 (960 × 240) pixels
Viewfinder	Monitor Screen
Timekeeping Functions . . .	Built-in quartz digital clock Date and Time: Recorded with image data, Time stamp Auto Calendar: To 2049
World Time.162 cities in 32 time zones City name, date, time, summer time
Input/Output Terminals . . .	Cradle contact
USB	USB 2.0 Hi-Speed compatible
Microphone	Monaural
Speaker	Monaural

■ Power Supply

Power Requirements Lithium ion rechargeable battery
(NP-20) × 1

Approximate Battery Life

All of the values provided below represent the approximate amount of time under normal temperature (23°C (73°F)) before the camera turns off. These values are not guaranteed. Low temperatures shorten battery life.

Number of Shots (CIPA)*1	200 shots
Continuous Playback (Snapshots)*2	290 minutes
Continuous Movie Recording	90 minutes
Continuous Voice Recording*3	400 minutes

- Battery: NP-20 (Rated Capacity: 700 mAh)
- Recording Medium: SD memory card
- Measurement Conditions

*1 Number of Shots (CIPA)

In accordance with CIPA standards

Normal temperature (23°C (73°F)), monitor on, zoom operation between full wide and full telephoto every 30 seconds, during which two images are shot with flash; power turned off and back on every time 10 images are shot.

*2 Continuous Playback Time

Standard temperature (23°C (73°F)), one-image scroll approximately every 10 seconds

*3 Approximate continuous recording time

- The above values are based a new battery, starting from a full charge. Repeated charging shortens battery life.
- Frequency of flash, zoom, and Auto Focus usage, and the time the camera is on greatly affects recording time and number of shots values.

Power Consumption	3.7 V DC; Approximately 4.3 W
Dimensions	94.5 (W) × 60.4 (H) × 17.3 (D) mm (3.7"(W) × 2.4"(H) × 0.7"(D)) (Excluding projections; 13.7 mm (0.5") at thinnest point)
Weight	Approximately 127 g (4.5 oz) (excluding battery and bundled accessories)
Bundled Accessories	Rechargeable Lithium Ion Battery (NP- 20); USB Cradle (CA-34); Special AC Adaptor (AD-C52S or AD-C52G)/AC Power Cord; USB Cable; AV Cable; Strap; CD-ROM; Basic Reference

■ Rechargeable Lithium Ion Battery (NP-20)

Rated Voltage3.7 V
Rated Capacitance700 mAh
Operating Temperature	...0 to 40°C (32 to 104°F)
Dimensions33.0(W) × 50.0(H) × 4.7(D) mm (1.3"(W) × 2.0"(H) × 0.19"(D))
WeightApproximately 16 g (0.56 oz)

■ USB Cradle (CA-34)

Input/Output Terminals	...Camera contact; USB port; external power supply terminal (DC IN 5.3 V); AV terminal (AV OUT: NTSC/PAL standards)
Power Consumption5.3 V DC, Approximately 3.2 W
Dimensions109 (W) × 24 (H) × 58 (D) mm (4.3"(W) × 0.9"(H) × 2.3"(D)) (Excluding projections)
WeightApproximately 47 g (1.7 oz)

■ Special AC Adaptor (Inlet Type) (AD-C52S)

Input Power100 to 240 V AC 50/60Hz 90 mA
Output Power5.3 V DC 650 mA
Dimensions63 (W) × 20 (H) × 50 (D) mm (2.5"(W) × 0.8"(H) × 2.0"(D)) (Excluding projections and cable)
WeightApproximately 76 g (2.7 oz)

■ Special AC Adaptor (Inlet Type) (AD-C52G)

Input Power100 to 240 V AC 50/60Hz 83 mA
Output Power5.3 V DC 650 mA
Dimensions50 (W) × 20 (H) × 70 (D) mm (2.0"(W) × 0.8"(H) × 2.8"(D)) (Excluding projections and cable)
WeightApproximately 90 g (3.2 oz)

- Power cord precautions for use in Singapore
The power cord set is not supplied. The power cord used must comply with relevant national and/or international standards.

CASIO®

CASIO COMPUTER CO.,LTD.
6-2, Hon-machi 1-chome
Shibuya-ku, Tokyo 151-8543, Japan

MA0610-B