

TOSHIBA



DVD VIDEO PLAYER & VIDEO CASSETTE RECORDER

SD-KV540SU OWNER'S MANUAL

VHS Hi-Fi SQPB

Before connecting, operating or adjusting this product,
please read this instruction booklet carefully and completely.

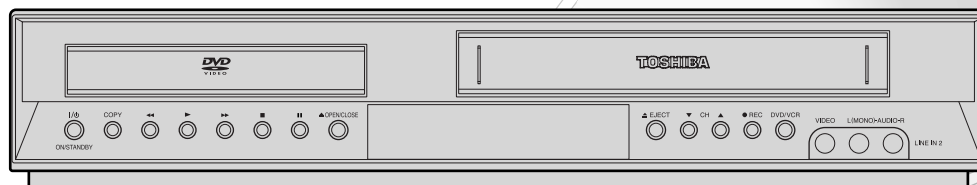

Safety Precautions



CAUTION
RISK OF ELECTRIC SHOCK
DO NOT OPEN



CAUTION: TO REDUCE THE RISK OF ELECTRIC SHOCK DO NOT REMOVE COVER (OR BACK) NO USER-SERVICEABLE PARTS INSIDE REFER SERVICING TO QUALIFIED SERVICE PERSONNEL.



This lightning flash with arrowhead symbol within an equilateral triangle is intended to alert the user to the presence of uninsulated dangerous voltage within the product's enclosure that may be of sufficient magnitude to constitute a risk of electric shock to persons.



The exclamation point within an equilateral triangle is intended to alert the user to the presence of important operating and maintenance (servicing) instructions in the literature accompanying the product.

WARNING: TO REDUCE THE RISK OF FIRE OR ELECTRIC SHOCK, DO NOT EXPOSE THIS APPARATUS TO RAIN OR MOISTURE.

CAUTION: TO PREVENT ELECTRIC SHOCK, MATCH WIDE BLADE OF PLUG TO WIDE SLOT, FULLY INSERT.

ATTENTION: POUR ÉVITER LES CHOC ÉLECTRIQUES, INTRODUIRE LA LAME LA PLUS LARGE DE LA FICHE DANS LA BORNE CORRESPONDANTE DE LA PRISE ET POUSSER JUSQU'AU FOND.

WARNING: Do not install this equipment in a confined space such as a bookcase or similar unit.

NOTE TO CABLE/TV INSTALLER: This reminder is provided to call the cable TV system installer's attention to Article 820-40 of the National Electric Code (U.S.A.). The code provides guidelines for proper grounding and, in particular, specifies that the cable ground shall be connected to the grounding system of the building, as close to the point of the cable entry as practical.

CAUTION:

This DVD/VCR receiver employs a Laser System.

To ensure proper use of this product, please read this owner's manual carefully and retain for future reference. Should the unit require maintenance, contact an authorized service location.

Use of controls, adjustments, or the performance of procedures other than those specified herein may result in hazardous radiation exposure.

To prevent direct exposure to laser beam, do not try to open the enclosure. Visible laser radiation when open. DO NOT STARE INTO BEAM.

CAUTION: The apparatus should not be exposed to water (dripping or splashing) and no objects filled with liquids, such as vases, should be placed on the apparatus.

FCC WARNING: This equipment may generate or use radio frequency energy. Changes or modifications to this equipment may cause harmful interference unless the modifications are expressly approved in the instruction manual. The user could lose the authority to operate this equipment if an unauthorized change or modification is made.

REGULATORY INFORMATION: FCC Part 15

This equipment has been tested and found to comply with the limits for a Class B digital device, pursuant to Part 15 of the FCC Rules. These limits are designed to provide reasonable protection against harmful interference when the product is operated in a residential installation. This product generates, uses, and can radiate radio frequency energy and, if not installed and used in accordance with the instruction manual, may cause harmful interference to radio communications. However, there is no guarantee that interference will not occur in a particular installation. If this product does cause harmful interference to radio or television reception, which can be determined by turning the product off and on, the user is encouraged to try to correct the interference by one or more of the following measures:

- Reorient or relocate the receiving antenna.
- Increase the separation between the product and receiver.
- Connect the product into an outlet on a circuit different from that to which the receiver is connected.
- Consult the dealer or an experienced radio/TV technician for help.

SERIAL NUMBER: The serial number is found on the back of this unit. This number is unique to this unit and not available to others. You should record requested information here and retain this guide as a permanent record of your purchase.

Model No. _____

Serial No. _____

IMPORTANT SAFETY INSTRUCTIONS

- 1. Read these instructions.** - All these safety and operating instructions should be read before the product is operated.
- 2. Keep these instructions.** - The safety, operating and use instructions should be retained for future reference.
- 3. Heed all warnings.** - All warnings on the product and in the operating instructions should be adhered to.
- 4. Follow all instructions.** - All operating and use instructions should be followed.
- 5. Do not use this product near water.** - For example: near a bath tub, wash bowl, kitchen sink, laundry tub, in a wet basement; or near a swimming pool; and other areas located near water.
- 6. Clean only with dry cloth.** - Unplug this product from the wall outlet before cleaning. Do not use liquid cleaners.
- 7. Do not block any ventilation openings. Install in accordance with the manufacturer's instructions.** - Slots and openings in the cabinet are provided for ventilation and to ensure reliable operation of the product and to protect it from over-heating. The openings should never be blocked by placing the product on a bed, sofa, rug or other similar surface. This product should not be placed in a built-in installation such as a bookcase or rack unless proper ventilation is provided or the manufacturer's instructions have been adhered to.
- 8. Do not install near any heat sources such as radiators, heat registers, stoves, or other apparatus (including amplifiers) that produce heat.**
- 9. Do not defeat the safety purpose of the polarized or grounding-type plug.** A polarized plug has two blades with one wider than the other. A grounding type plug has two blades and a third grounding prong. The wide blade or the third prong are provided for your safety. If the provided plug does not fit into your outlet, consult an electrician for replacement of the obsolete outlet.
- 10. Protect the power cord from being walked on or pinched particularly at plugs, convenience receptacles, and the point where they exit from the product.**
- 11. Only use attachments/accessories specified by the manufacturer.**
- 12. Use only with the cart, stand, tripod, bracket, or table specified by the manufacturer, or sold with apparatus. When a cart is used, use caution when moving the cart/product combination to avoid injury from tip-over.**
- 13. Unplug this product during lightning storms or when unused for long periods of time.**
- 14. Refer all servicing to qualified service personnel. Servicing is required when the product has been damaged in any way, such as power-supply cord or plug is damaged, liquid has been spilled or objects have fallen into the product, the product has been exposed to rain or moisture, does not operate normally, or has been dropped.**



Table of Contents

Safety Precautions	2		
IMPORTANT SAFETY INSTRUCTIONS	3		
Table of contents	4		
Before Use	5-11		
Moisture Condensation	5		
Symbol Used in this Manual	5		
About the  Symbol Display	5		
Notes on Discs	5		
Types of Playable Discs	6		
Disc-related terms	6		
Regional code	7		
Notes on Copyrights	7		
About the Remote Control	7		
Selecting the Viewing Source	7		
Front Panel	8		
Display Window	9		
Rear Panel	10		
Remote Control	11		
Connections	12-14		
Connecting an Antenna or Cable TV	12		
Basic TV Connections	12-13		
Optional TV Connections	13		
Audio Connection for DVD	13-14		
Initial Settings - VCR	15-16		
General Operation	15		
CLOCK	15		
• Auto Clock Set	15		
• Manual Clock Set	15		
PROGRAM	15		
TUNING	16		
• Auto Channel Programming	16		
• To Add or Erase Channels	16		
SETUP	16		
Initial Settings - DVD	17-20		
General Operation	17		
LANGUAGE	17		
• Menu Language	17		
• Disc Audio / Subtitle / Menu	17		
DISPLAY	18		
• TV Aspect	18		
• Display Mode	18		
• Progressive Scan	18		
• Video Output	18		
AUDIO	19		
• Dolby Digital / DTS / MPEG	19		
• Sample Freq. (Frequency)	19		
• DRC (Dynamic Range Control)	19		
OTHERS	19		
• PBC	19		
• Auto Play	19		
• B.L.E. (Black Level Expansion)	19		
LOCK (Parental Control)	20		
• Rating	20		
• Password (Security Code)	20		
• Area Code	20		
Operation with tape	21-28		
VCR Tape Playback	21-22		
• Basic Instructions	21		
• Auto Tracking	21		
• Manual Tracking	21		
• Search	21		
• Still Picture and Frame-by-Frame Playback	21		
• Slow Motion	22		
• CM SKIP (Commercial Skip)	22		
• Blank Search	22		
• VISS (VHS Index Search System)	22		
VHS Hi-Fi Stereo / MTS Broadcast	23		
VCR Tape Recording	24-27		
• Basic Instructions	24		
• Timer Recording	24-25		
• One-touch Timer Recording	26		
• Recording from External Components	26		
• Copying from DVD to VCR	27		
On-Screen Display - VCR	27		
Additional VCR Information	28		
• VCR Auto Play System	28		
• S-VHS Quasi Playback (SQPB)	28		
• Easy Information	28		
Operation with DVD and Video CD	29-32		
Playback Setup	29		
General Features	29-31		
• Moving to another TITLE	29		
• Moving to another CHAPTER/TRACK	29		
• Slow Motion	29		
• Still Picture and Frame-by-Frame Playback	30		
• Search	30		
• Time Search	30		
• Marker Search	30		
• Repeat	30		
• Repeat A-B	30		
• Zoom	30		
• Changing the Audio Channel	31		
• Last Scene Memory	31		
• Instant Replay	31		
• Screen Saver	31		
Special DVD Features	31		
• Checking the contents of DVD discs: Menus	31		
• Title Menu	31		
• Disc Menu	31		
• Camera Angle	31		
• Changing the Audio Language	31		
• Subtitles	31		
On-Screen Display - DVD	32		
Maintenance and Service	32		
Playing an Audio CD or MP3 / WMA Disc	33-35		
Audio CD and MP3 / WMA Disc Features	34		
• Pause	34		
• Moving to another Track	34		
• Repeat Track/All/Off	34		
• Search	34		
• Random	34		
• Repeat A-B	34		
Programmed Playback	35		
Viewing a JPEG Disc	36		
• Slide Show	36		
• Still Picture	36		
• Moving to another File	36		
• Zoom	36		
• To rotate picture	36		
Language and Area Code List	37		
Troubleshooting	38-39		
Specifications	40		

Before Use

To ensure proper use of this product, please read this owner's manual carefully and retain for future reference.

This manual provides information on the operation and maintenance of your DVD+VCR. Should the unit require service, contact an authorized service location.

Moisture Condensation

Never operate the DVD+VCR immediately after moving it from a cold location to a warm location. Leave it for two or three hours without operating it. If you use the DVD+VCR in such a situation, it may damage discs/ tapes and internal parts.

Symbol Used in this Manual



The lightning flash symbol alerts you to the presence of dangerous voltage within the product enclosure that may constitute a risk of electric shock.



The exclamation point alerts you to the presence of important operating and maintenance/ servicing instructions.



Indicates hazards likely to cause harm to the unit itself or other material damage.

Note: Indicates special notes and operating features.

Tip: Indicates tips and hints for making the task easier.

A section whose title has one of the following symbols is applicable only to the disc represented by the symbol.

- DVD** DVD
- VCD** Video CDs
- CD** Audio CDs
- MP3** MP3 Discs
- WMA** WMA Discs
- JPEG** JPEG Discs

About the Symbol Display

"" may appear on your TV display during operation and indicates that the function is not permitted by this unit or the disc.

Notes on Discs

Handling Discs

Do not touch the playback side of the disc. Hold the disc by the edges so that fingerprints do not get on the surface. Never stick paper or tape on the disc.

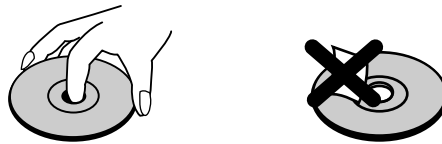

Storing Discs

After playing, store the disc in its case. Do not expose the disc to direct sunlight or sources of heat and never leave it in a parked car exposed to direct sunlight.

Cleaning Discs

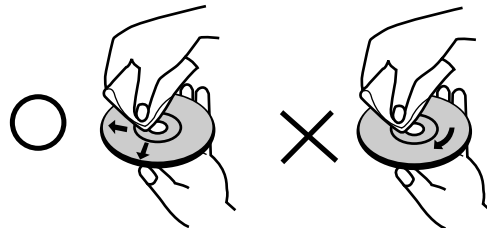

Fingerprints and dust on the disc can cause poor picture quality and sound distortion. Before playing, clean the disc with a clean cloth. Wipe the disc from the center out.



Do not use strong solvents such as alcohol, benzene, thinner, commercially available cleaners, or anti-static spray intended for older vinyl records.

Before Use (Continued)

Types of Playable Discs

	DVD (8 cm/12 cm disc)
	Video CD (VCD) (8 cm / 12 cm disc)
	Audio CD (8 cm/12 cm disc)

In addition, this unit plays DVD-R, DVD+R, DVD-RW, DVD+RW, SVCD, and CD-R / CD-RW that contains audio titles, MP3, WMA, and/or JPEG files.

Notes:

- Depending on the conditions of the recording equipment or the CD-R/RW (or DVD -R, DVD +R, DVD -RW, DVD +RW) disc itself, some CD-R/RW (or DVD -R, DVD +R, DVD -RW, DVD +RW) discs cannot be played on the unit.
- Only plays if DVD-RW is recorded in Video mode and has been finalized.
- Do not attach any seal or label to either side (the labeled side or the recorded side) of a disc.
- Do not use irregularly shaped CDs (e.g., heart-shaped or octagonal) since they may result in malfunctions.

Notes on DVDs and Video CDs

Some playback operations of DVDs and Video CDs may be intentionally programmed by software manufacturers. This unit plays DVDs and Video CDs according to disc content designed by the software manufacturer, therefore some playback features may not be available or other functions may be added.

Because of problems and errors that can occur during the creation of DVD software and/or the manufacture of DVD discs, Toshiba cannot guarantee that this player will play every feature of every DVD bearing the DVD logo. As one of the creators of DVD technology, Toshiba DVD+VCR players are manufactured using the highest standards of quality, and as a result, such incompatibilities are rare. If you happen to experience any difficulty playing a DVD on a Toshiba DVD+VCR player, please feel free to call our Contact listed in "Limited United States Warranty" (see page 41).

Disc-related terms

VCD (Video CD)

A VCD holds up to 74 minutes (650 MB disc) or 80 minutes (700 MB disc) of MPEG-1 full-motion video along with quality stereo sound.

MPEG

MPEG is an international standard for video and audio compression. MPEG-1 is used in encoding video for VCD and provides for multichannel surround sound coding such as PCM, Dolby Digital, DTS and MPEG audio.

MP3

MP3 is a popular compression format used for digital audio files that yields very high near-CD quality.

WMA

Windows media audio file. A type of coding / decoding developed by Microsoft Corp.

JPEG

Joint Pictures Expert Group. JPEG is a compressed file format that allows you to save images with no limit on the number of colors.

PBC: Playback Control (Video CD only)

Playback control is available for Video CD (VCD) version 2.0 disc formats. PBC allows you to interact with the system via menus, search functions, or other typical computer-like operations. Moreover, still pictures of high resolution can be played if they are included in the disc. Video CDs not equipped with PBC (Version 1.1) operate in the same way as audio CDs.

Title (DVD only)

A title is generally a distinct section of a DVD disc. For example the main feature could be title 1, a documentary describing how the film was made could be title 2, and cast interviews could be title 3. Each title is assigned a reference number enabling you to locate it easily.

Chapter (DVD only)

A chapter is a segment of a title such as a scene in a film or one interview in a series. Each chapter is assigned a chapter number, enabling you to locate the chapter you want. Depending on the disc, chapters may not be recorded.

Scene (VCD)

On a video CD with PBC (playback control) functions, moving pictures and still pictures are divided into sections called "scenes". Each scene is displayed in the menu screen and assigned a scene number, enabling you to locate the scene you want. A scene is composed of one or several tracks.

Track

A distinct element of audiovisual information, such as the picture or sound track for a specific language (DVD), or a musical piece on a video or audio CD. Each track is assigned a track number, enabling you to locate the track you want. DVD discs allow one track of video (with multiple angles) and several tracks of audio.

Before Use (Continued)

Regional code

This DVD+VCR is designed and manufactured for playback of region "1" encoded DVD software. This unit can play only DVD discs labeled "1" or "ALL".



Notes on Regional Codes

- Most DVD discs have a globe with one or more numbers in it clearly visible on the cover. This number must match your DVD+VCR's regional code or the disc cannot play.
- If you try to play a DVD with a different region code from your player, the message "Check Regional Code" appears on the TV screen.

Notes on Copyright

The unauthorized recording, use, distribution, or revision of television programs, videotapes, DVDs and other materials, is prohibited under the Copyright Laws of the United States and other countries, and may subject you to civil and/or criminal liability.

This product incorporates copyright protection technology that is protected by method claims of certain U.S. patents and other intellectual property rights owned by Macrovision Corporation and other rights owners. Use of this copyright protection technology must be authorized by Macrovision Corporation, and is intended for home and other limited viewing uses only unless otherwise authorized by Macrovision Corporation. Reverse engineering or disassembly is prohibited.

Notice for Progressive Scan Use

CONSUMERS SHOULD NOTE THAT NOT ALL HIGH DEFINITION TELEVISION SETS ARE FULLY COMPATIBLE WITH THIS PRODUCT AND MAY CAUSE ARTIFACTS TO BE DISPLAYED IN THE PICTURE. IN CASE OF 525 PROGRESSIVE SCAN PICTURE PROBLEMS, IT IS RECOMMENDED THAT THE USER SWITCH THE CONNECTION TO THE 'STANDARD DEFINITION' OUTPUT. IF THERE ARE QUESTIONS REGARDING OUR TV SET COMPATIBILITY WITH THIS MODEL 525p DVD+VCR, PLEASE CONTACT OUR CUSTOMER SERVICE CENTER.

About the Remote Control

Operation Range

Point the remote control at the remote sensor and press the buttons.

Distance: About 23 ft (7 m) from the front of the remote sensor.

Angle: About 30° in each direction of the front of the remote sensor.

Battery installation

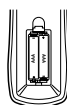

Detach the battery cover on the rear of the remote control, and insert two (R03/AAA) size batteries with ⊕ and ⊖ aligned correctly.



Caution

Never throw batteries into a fire.

Notes:

- Be sure to use AAA size batteries.
- Dispose of batteries in a designated disposal area.
- Batteries should always be disposed of with the environment in mind. Always dispose of batteries in accordance with applicable laws and regulations.
- If the remote control does not operate correctly, or if the operating range becomes reduced, replace batteries with new ones.
- When necessary to replace batteries in the remote control, always replace both batteries with new ones. Never mix battery types or use new and used batteries in combination.
- Always remove batteries from remote control if they are dead or if the remote control is not to be used for an extended period of time. This will prevent battery acid from leaking into the battery compartment.

Selecting the Viewing Source

You must select one of your output sources (DVD or VCR) to view on the TV screen.

- If you want to view DVD deck output source:
Press DVD until DVD indicator in the display window lights and output source of DVD deck is viewed on the TV screen.
- If you want to view VCR deck output source:
Press VCR until VCR indicator in the display window lights and output source of VCR deck is viewed on the TV screen.

Notes:

- If you insert a disc while the DVD+VCR is in the VCR mode, the DVD+VCR will switch to DVD mode automatically.
- If you insert a cassette tape without prevention tab while the DVD+VCR is in the DVD mode, the DVD+VCR will switch to VCR mode automatically.

Front Panel

Disc Tray (DVD deck)

Insert a disc here.

Cassette Compartment (VCR deck)

Insert a video cassette here.

Remote Sensor

Point the DVD+VCR remote control here.

Display Windows

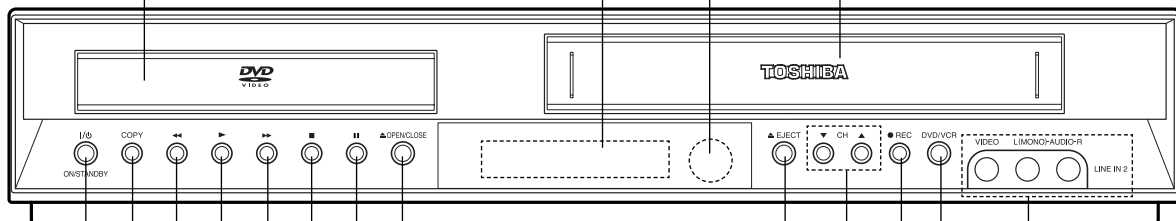

▲ OPEN/CLOSE

Opens or closes the disc tray.

⏸ (P/STILL)

Pause playback or recording.
Press repeatedly for frame-by-frame playback.



Stops playback of the disc or tape.

▲ EJECT

Ejects the tape in the VCR deck.

CH (▼/▲)

To scan up or down through memorized channels.



DVD: Skip to next chapter or track. Press and hold for two seconds for a fast forward search.

VCR: Advances the tape during the STOP mode or for fast forward picture search.



Starts playback of a disc or tape.

● REC

To record normally or to activate One-touch Timer Recording by repeated presses.



- **DVD:** Skip to beginning of current chapter or track, press twice in quick successions to go to previous chapter or track. Press and hold button for about two seconds to search backward.

- **VCR:** Rewinds the tape during the stop mode or for fast reverse picture search.

DVD/VCR

Select one of your output sources to view on the TV screen between DVD and VCR.

COPY

Press to copy a DVD in the DVD deck to a VHS tape in the VCR deck.

LINE IN 2 (VIDEO/AUDIO (L/R))

Connect to the audio/video output of an external source (Audio system, TV/Monitor, Another VCR).

ON/STANDBY

Switches the DVD+VCR ON and OFF.

Display Window

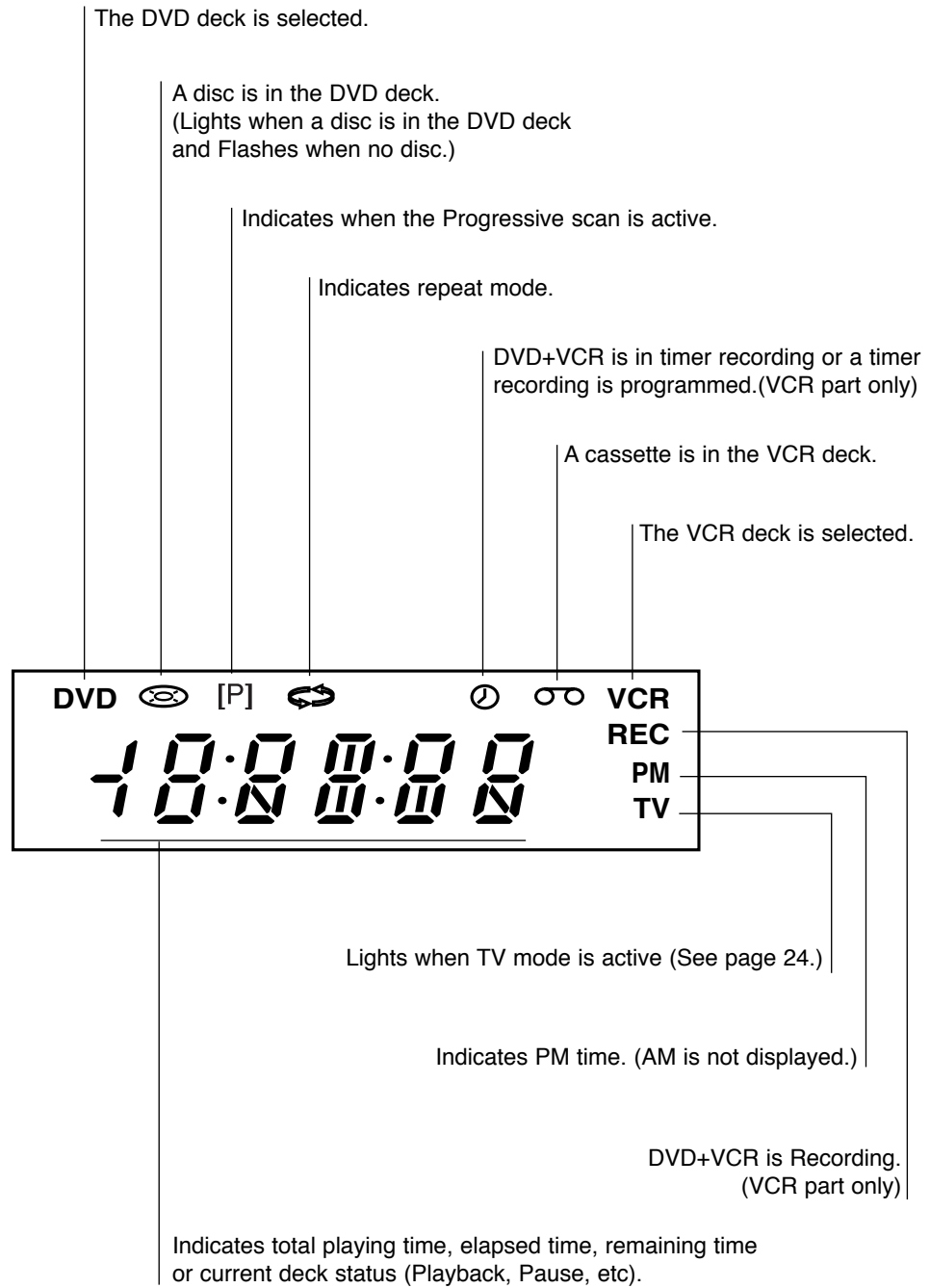

Rear Panel

VCR IN LINE 1 (VIDEO/AUDIO (Left/Right))

Connect the audio/video output of an external source (Audio system, TV/Monitor, VCR, Camcorder).

DVD/VCR OUT (VIDEO/AUDIO (Left/Right))

Connect to a TV with video and audio inputs.

COMPONENT/PROGRESSIVE SCAN VIDEO OUT (Y Pb Pr) (DVD OUT)

Connect to a TV with Y Pb Pr inputs.

AUDIO OUT (Left/Right) (DVD OUT)

Connect to a TV or other equipment with audio inputs.

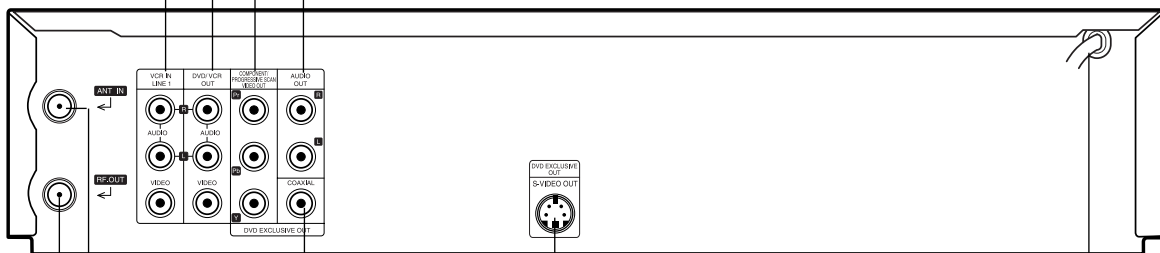

AC Power Cord
Plug into the power source.

S-VIDEO OUT (DVD OUT)

Connect to a S-Video Input on TV.

COAXIAL (DIGITAL AUDIO OUT jack) (DVD OUT)

Connect to digital (coaxial) audio equipment.

ANT.IN

Connect the VHF/UHF/CATV antenna to this terminal.

RF. OUT

Connect to a TV with RF coaxial inputs.



Do not touch the inner pins of the jacks on the rear panel. Electrostatic discharge may cause permanent damage to the unit.

Remote Control

- POWER (I/O)**
Switches DVD+VCR ON and OFF.
- TV/VCR ●**
To view channels selected by the VCR tuner or by the TV tuner.
- DVD ●**
Select the DVD+VCR function mode to DVD.
- VCR ●**
Select the DVD+VCR function mode to VCR.
- DISPLAY**
Accesses On-Screen Display.
- CLOCK/COUNTER**
Switches among the clock, tape counter and tape remaining modes on the display.
- CH/TRK (▲/▼)**
- Selects menu options.
- CH/TRK (▲/▼): Selects VCR channels. Adjusts manually the tape's picture onscreen.
- VCR MENU/SETUP**
Accesses or removes DVD Setup menu and VCR menu.
- ENTER**
Confirms menu selections. Displays functions on the TV screen.
- PAUSE/STEP (II/III▶)**
- Pause playback or recording.
- Press repeatedly for frame-by-frame playback.
- REW (◀◀)**
- For fast reverse picture search.
- Rewinds the tape during the STOP mode.
- PLAY (▶▶)**
Starts playback.
- FWD (▶▶▶)**
- For fast forward picture search.
- Advances the tape during the STOP mode.
- 0-9**
Selects numbered options in a menu.
- REPEAT ●**
Repeat chapter, track, title or all.
- RANDOM ●**
Plays tracks in random order.
- CM SKIP ●**
Fast forwards picture search through 30 seconds of recording.
- A-B RPT ●**
Repeats sequence between two points (A and B).
- SP/SLP ●**
Selects recording speed.
- SLOW (I▶)**
Forward slow playback of tape and disc.

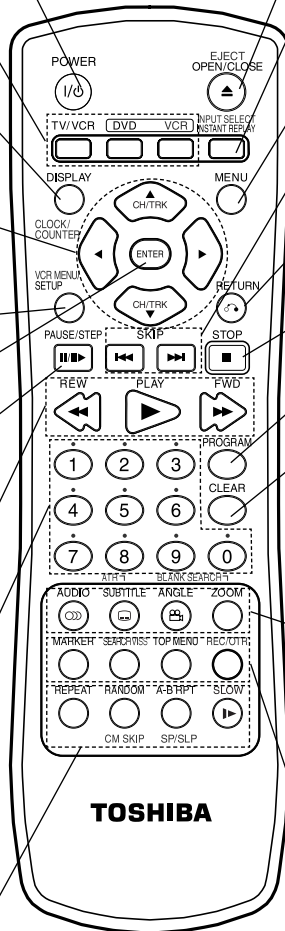

- EJECT, OPEN/CLOSE (▲)**
- Ejects the tape in the VCR deck.
- Opens and closes the disc tray.
- INPUT SELECT/INSTANT REPLAY**
- Selects the VCR deck's source (Tuner, LINE 1, or LINE 2).
- Replays through 10 seconds of DVD playback.
- MENU**
Accesses menu on a DVD disc.
- SKIP (◀◀ / ▶▶)**
Skip to beginning of current chapter or track, press twice in quick successions to go to previous chapter or track. Skip to next chapter or track.
- RETURN (↶)**
- Removes the setup menu.
- Displays the menu of a video CD with PBC.
- STOP (■)**
Stops playback or recording.
- PROGRAM**
Places a track on the program list.
- CLEAR**
Removes a track number on the program menu or a mark on the MARKER SEARCH menu.
- AUDIO**
Selects an audio language (DVD) or an audio channel (VCD).
- SUBTITLE**
Selects a subtitle language.
- ATR**
Adjusts automatically the tape's picture onscreen.
- ANGLE**
Selects a DVD camera angle, if available.
- ZOOM**
Enlarges DVD video image.
- BLANK/SEARCH**
Finds end points of recording.
- MARKER**
Marks any point during playback.
- SEARCH/VISS**
- Displays Marker Search menu.
- Enters the VISS function mode.
- TOP MENU**
Displays the disc's Title menu, if available.
- REC/OTR**
Records normally or activates One touch Timer Recording with repeated presses.

Connections

Depending on your TV and other equipment there are various ways you can connect the player. Please refer to the manuals of your TV, VCR, stereo system or other devices as necessary for additional connection information.

Notes:

- The picture and sound of a nearby TV, VCR, or radio may be distorted during playback. Position the units away from each other or turn off the unit after removing the disc.
- Make sure the DVD+VCR is connected directly to the TV and tune the TV to the correct video input channel.
- Do not connect the DVD+VCR's AUDIO OUT jack to the phono in jack (record deck) of your audio system. Do not connect the DVD+VCR via another VCR. The DVD image could be distorted by the copy protection system.

Connecting an Antenna or Cable TV

1 Antenna:

Disconnect the antenna from the rear of the TV and identify the antenna cable. If it is a round 75 ohm coaxial cable connect it directly to the jack marked ANT.IN on your DVD+VCR. If your antenna cable is flat connect it to a 300-ohm to 75-ohm antenna adaptor (not supplied) and slip the adaptor over the ANT.IN jack. Don't attempt to screw it into the DVD+VCR.

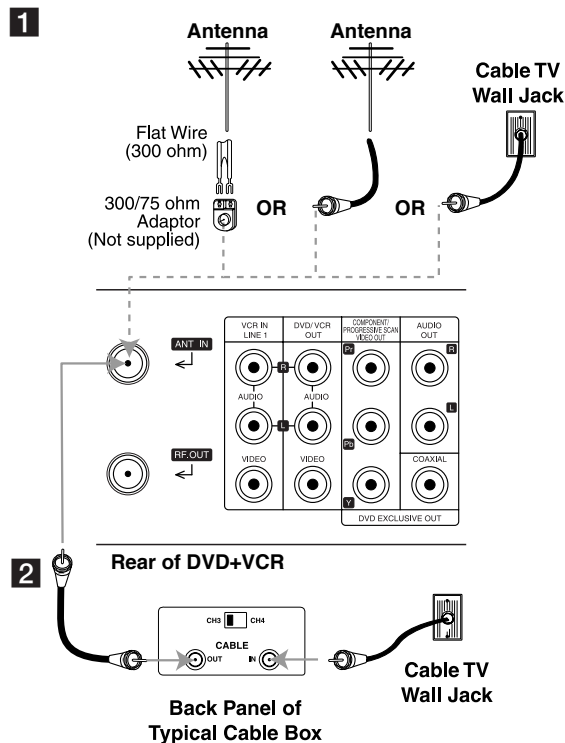

2 Cable TV:

If your cable connection has no converter or descrambler, unscrew the cable from your TV and attach it to the ANT.IN jack on the DVD+VCR. If a converter is required connect a coaxial cable from the wall jack to the IN connector on the converter, and a coaxial cable from the OUT connector on the converter to the ANT IN on your DVD+VCR. This cable hookup permits both TV and DVD+VCR operation.

To view or record a CATV channel

1. Tune the TV to the DVD+VCR output channel (CH 3 or 4).
2. Set the DVD+VCR channel selector to the cable output channel. (Example: CH3)
3. Select a channel using the cable converter.

Notes:

- With this connection, you cannot record one program while viewing another.
- If you are using a cable box to tune channels, it is not necessary to do Auto Channel Set.

Basic TV Connections

Make one of the following connections, depending on the capabilities of your TV.

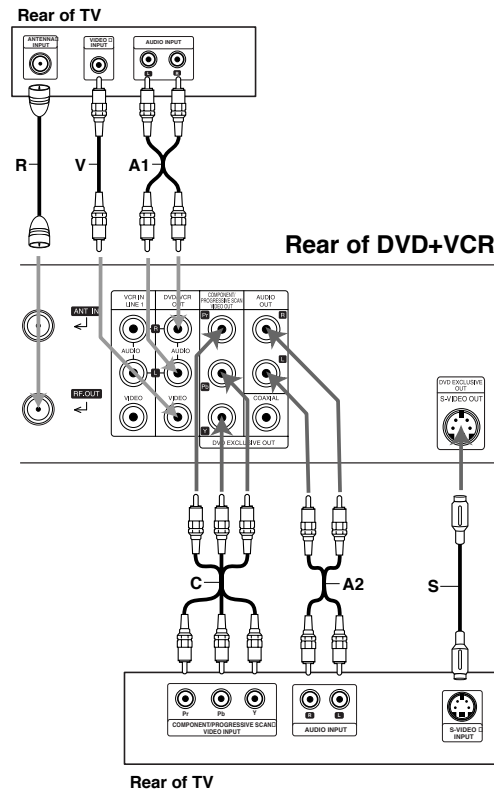

Connections (Continued)

RF coaxial connection

Connect the RF.OUT jack on the DVD+VCR to the antenna in jack on the TV using the supplied 75-ohm Coaxial Cable (**R**).

How to set the DVD+VCR's RF output channel

1. When the DVD+VCR is turned off, press and hold CH (▼/▲) on the front panel for more than five seconds. "RF03" or "RF04" appears in the display window.
2. Press CH (▼/▲) to change the RF output channel (RF03 or RF04). Tune the TV to this channel.
3. Turn off the DVD+VCR.

Audio/Video connection

1. Connect the DVD/VCR VIDEO OUT jack on the DVD+VCR to the video in jack on the TV using the video cable supplied (**V**).
2. Connect the Left and Right DVD/VCR AUDIO OUT jacks on the DVD+VCR to the audio left/right in jacks on the TV (**A1**) using the supplied audio cables.

Note:

If you use this connection, set the TV's source selector to VIDEO.

Optional TV Connections

These connections support only DVD playback. The tuner and VCR can only output through the RF.OUT (**R**) or DVD/VCR OUT (**A, V**) jacks.

S-Video connection

1. Connect the S-VIDEO OUT jack on the DVD+VCR to the S-Video in jack on the TV using the optional S-Video cable (**S**).
2. Connect the Left and Right AUDIO OUT jacks of the DVD+VCR to the audio left/right in jacks on the TV using the supplied audio cables (**A2**).

Note:

Set the Video Output to "S-VIDEO" on the setup menu for S-VIDEO signal, see page 18.

Component Video (ColorStream®) / Progressive Scan (ColorStream Pro®) connection

If your television is a high-definition or "digital ready" television, you may take advantage of the DVD+VCR's progressive scan output for the highest video resolution possible.

1. Connect the COMPONENT/PROGRESSIVE SCAN VIDEO OUT jacks on the DVD+VCR to the corresponding in jacks on the TV using an optional Y Pb Pr cable (**C**).
2. Connect the Left and Right AUDIO OUT jacks of the DVD+VCR to the audio left/right in jacks on the TV using the supplied audio cables (**A2**).

Notes:

- Set the Video Output to "YPbPr" and Progressive Scan to "On" on the setup menu for progressive scan signal, see page 18.
- When you use Component Video signal, set the Progressive Scan to "Off" on the setup menu.
- Progressive scan does not work with the analog video connections (yellow VIDEO OUT jack and S-VIDEO OUT jack).
- Do not use Component Video jacks and S-VIDEO jack at the same time, the picture quality will be poor.
- If your TV does not accept the Progressive Scan format, the picture will appear scrambled.

Audio Connection for DVD

You can only listen to DVD playback using COAXIAL (**X**) and AUDIO OUT (**A2**) connections. The tuner and VCR can only be heard through the RF.OUT (**R**) or DVD/VCR AUDIO OUT (**A1**) jack. (See page 12.)

Connecting to an amplifier equipped with two channel analog stereo or Dolby Pro Logic II/Pro Logic

Connect the Left and Right AUDIO OUT (or DVD/VCR AUDIO OUT) jacks on the DVD+VCR to the audio left and right in jacks on your amplifier, receiver, or stereo system using the audio cables (**A1, A2**) supplied.

Connections (Continued)

Connecting to an amplifier equipped with two channel digital stereo (PCM) or to an Audio/Video receiver equipped with a multi-channel decoder (Dolby Digital, MPEG 2, or DTS)

1. Connect one of the DVD+VCR's DIGITAL AUDIO OUT jacks (COAXIAL X) to the corresponding in jack on your amplifier. Use an optional digital (COAXIAL X) audio cable.
2. You will need to activate the DVD+VCR's digital output. (See "AUDIO" on page 19).

Digital Multi-channel sound

A digital multi-channel connection provides the best sound quality. For this you need a multi-channel Audio/Video receiver that supports one or more of the audio formats supported by your DVD+VCR (MPEG 2, Dolby Digital and DTS). Check the receiver manual and the logos on the front of the receiver.

Caution:

Due to the DTS Licensing agreement, the digital output will be in DTS digital out when DTS audio stream is selected.

Notes:

- If the audio format of the digital output does not match the capabilities of your receiver, the receiver will produce a strong, distorted sound or no sound at all.
- Six Channel Digital Surround Sound via digital connection can only be obtained if your receiver is equipped with a Digital Multi-channel decoder.
- To see the audio format of the current DVD in the on-screen display, press AUDIO.

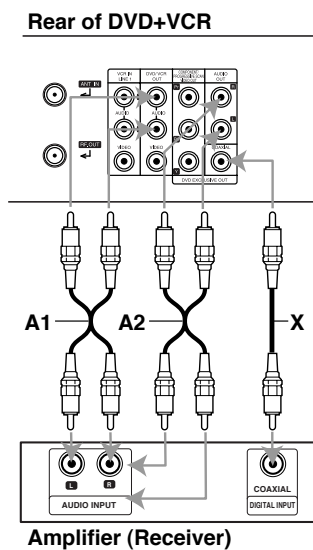

Manufactured under license from Dolby Laboratories. "Dolby", "Pro Logic", and the double-D symbol are trademarks of Dolby Laboratories.

DTS and DTS Digital Out are trademarks of Digital Theater Systems, Inc.

Accessory Audio/Video (A/V) Connections to DVD+VCR

Connect the VCR IN LINE 1 or LINE IN 2 jacks on the DVD+VCR to the audio/video out jacks on your accessory component, using the optional audio/video cables. (Refer to page 26 for "Recording from External Components")

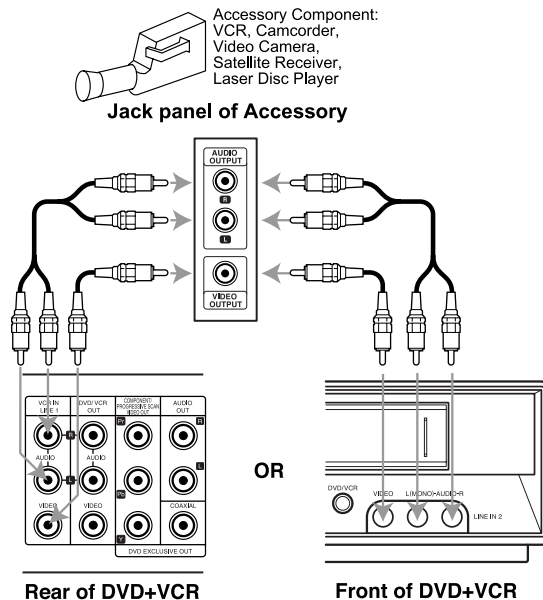

Initial Settings - VCR

By using the VCR Setup menu, you can make various adjustments to items such as clock setting, and timer recordings.

Your DVD+VCR allows remote control adjustment of several features.

General Operation

1. Press VCR on the remote control.
2. Press VCR MENU and the MAIN menu will appear.

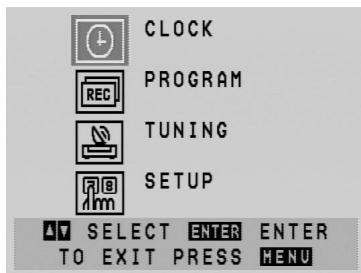

3. Use ▲/▼ to select the desired menu, then press ENTER.
4. Use ▲/▼ to choose a desired option on the selected Menu. Then use ◀/▶ to choose a desired setting.
5. Press VCR MENU when finished.

Note:

Menus remain on-screen for 3 minutes.

CLOCK

The DVD+VCR gives you two ways to set the time and date: the Auto Clock feature or Manually.

Auto Clock Set



AUTO CLOCK SET

The Auto Clock Set feature is set to ON at the factory. In the ON setting, the DVD+VCR looks for a channel carrying XDS (Extended Data Services) information. XDS updates the clock using the Coordinated Universal Time.

- Use ◀/▶ to choose ON or OFF.

DAYLIGHT SAVINGS

You can turn Daylight Savings On or Off manually. If you choose "AUTO", the DVD+VCR sets the clock using the DST information broadcast in the signal (channel).

- Use ◀/▶ to choose AUTO, ON or OFF.

TIME ZONE

You can set your local Time Zone manually. If you choose "AUTO", the DVD+VCR sets the clock using the first Coordinated Universal Time information it finds in a broadcast signal.

-Use ◀/▶ to choose the correct time zone (AUTO, EASTERN, CENTRAL, MOUNTAIN, PACIFIC, ALASKA or HAWAII).

Notes:

- The Auto Clock feature enables the DVD+VCR to set up the clock while the DVD+VCR is turned off.
- There are cases where the TV station does not send or sends wrong date and/or time information and the DVD+VCR sets the incorrect time. **If this happens we recommend that you set the clock manually.**

Manual Clock Set

Use ▲/▼/◀/▶ to enter the necessary information.

- MONTH : Choose the month.
- DAY : Choose the date.
The day of the week will display automatically.
- YEAR : Choose the year.
- TIME : Choose the time.
Press and hold ◀/▶ to advance clock continuously.

Notes:

- If setting the clock manually, "AUTO CLOCK SET" must set to "OFF". If it is set to "ON", an incorrect date and/or time will be entered again when the DVD+VCR is turned off.
- The clock uses the 12-hour system. Be sure to set AM and PM correctly (AM does not appear).

PROGRAM

The Timer Recording function allows you to record up to 8 programs within a period of one year. (See pages 24-25).

Initial Settings - VCR (Continued)

TUNING

This DVD+VCR is equipped with a frequency synthesized tuner capable of receiving up to 181 channels. These include VHF channels 2-13, UHF channels 14-69 and CATV channels 1-125.

Auto Channel Programming

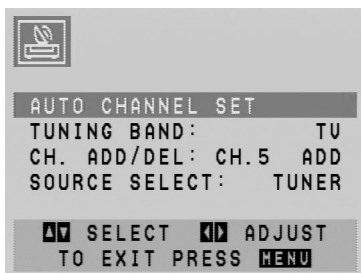

1. Choose the SOURCE SELECT option, then use ◀▶ to select TUNER.
Use ◀▶ to switch among TUNER, LINE1, and LINE2.
2. Choose the AUTO CHANNEL SET option, then use ◀▶ to find channels.
 - The tuner will automatically cycle through all available channels (TV/CATV) in the area and place them in the tuner's memory.
 - After the AUTO CHANNEL SET is complete, the TUNING menu will hide and return to the TV screen automatically.
3. Make sure the TUNING BAND is set appropriately (TV or CATV).
 - TV : If you are using a standard antenna to receive channels.
 - CATV : If you are using basic cable to receive channels.

To Add or Erase Channels

This feature allows you to add or erase channels from memory manually.

1. Choose the CH. ADD/DEL option, then use ◀▶ to select a channel to add or erase.
2. Use ENTER to add or erase the channel.
Repeat steps 1 and 2 to add or erase other channels.
3. Press VCR MENU to return to the TV screen.

SETUP

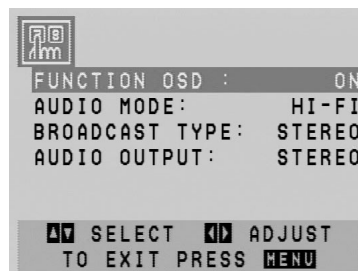

FUNCTION OSD

The on-screen display can be turned on or off.

AUDIO MODE

The DVD+VCR has two separate audio playback systems, the high quality VHS Hi-Fi system and standard NORMAL mono system. The same audio is generally recorded on both systems. The VHS Hi-Fi system plays on separate (left and right) channels, and the NORMAL system plays monaural sound. The normal track is always played so the cassette can be played on a DVD+VCR that does not have VHS Hi-Fi.

BROADCAST TYPE (STEREO / SAP / MONO)

Multichannel Television Sound (MTS) carries stereo and/or Second Audio Program (SAP) bilingual signals. Set this display to the desired position when both MTS stereo and SAP signals are received. When only one of the MTS signal is received, the DVD+VCR automatically selects the corresponding receiving mode (Stereo or SAP) regardless of the selected position. For normal operation, the display should be in the STEREO position. The DVD+VCR will then record a STEREO program when available, and record a mono program IF the program is NOT IN STEREO. For weak STEREO and/or SAP broadcasts, changing the display to mono may give clearer sound.

AUDIO OUTPUT (STEREO / LEFT / RIGHT)

Used during playback [when AUDIO MODE (HI-FI/NORMAL) is in HI-FI position] for selecting the audio output signals from the AUDIO OUT terminals (L ch and R ch), and RF.OUT. This display setting should normally be left in the stereo position, so that when a stereo tape is played, the stereo sound will be heard through the left and right channels. If a mono tape is played and the audio output is set to stereo, the same mono sound will be heard from both left and right channels.

Initial Settings - DVD

By using the DVD Setup menu, you can make various adjustments to items such as picture and sound. You can also set a language for the subtitles and the Setup menu, among other things. For details on each Setup menu item, see pages 17 to 20.

To display and exit the Menu:

Press SETUP to display the menu. A second press of SETUP will take you back to initial screen.

To go to the next level:

Press ► on the remote control.

To go back to the previous level:

Press ◀ on the remote control.

General Operation

1. Press DVD on the remote control.
2. Press SETUP.
The Setup menu appears.
3. Use ▲ / ▼ to select the desired option then press ► to move to the second level. The screen shows the current setting for the selected item, as well as alternate setting(s).
4. Use ▲ / ▼ to select the second desired option then press ► to move to the third level.
5. Use ▲ / ▼ to select the desired setting then press ENTER to confirm your selection. Some items require additional steps.
6. Press SETUP or PLAY (►) to exit the Setup menu.

LANGUAGE



Menu Language

Select a language for the VCR and DVD's setup menu and information display.

Disc Audio / Subtitle / Menu **DVD**

Select the language you prefer for the audio track (disc audio), subtitles, and the disc menu.

Original: Refers to the original language in which the disc was recorded.

Other: To select another language, press number buttons then ENTER to enter the corresponding 4-digit number according to the language code list in the reference chapter (see page 37). If you enter the wrong language code, press CLEAR.

Off (for Disc Subtitle) : Turn off Subtitle.

Initial Settings - DVD (Continued)

DISPLAY



TV Aspect **DVD**

4:3 : Select when a standard 4:3 TV is connected.

16:9 : Select when a 16:9 wide TV is connected.

Display Mode **DVD**

Display Mode setting works only when the TV Aspect mode is set to "4:3".

Letterbox: Displays a wide picture with bands on the upper and lower portions of the screen.

Panscan: Automatically displays the wide picture on the entire screen and cuts off the portions that do not fit.

Progressive Scan **DVD**

Progressive Scan setting works only when the Video Output mode is set to "YPbPr".

Progressive Scan Video provides the highest quality pictures with less flickering.

If you are using the Component Video jacks for connection to a TV or monitor that is compatible with a progressive scan signal, set Progressive Scan to On.

To turn on progressive scan:

Connect component/progressive out of this unit to the input of your monitor/television, set your television or monitor to component/progressive Input.

1. Select "Progressive Scan" on the DISPLAY menu then press ►.
2. Select "On" using the ▲ / ▼ buttons.
3. Press ENTER to confirm your selection. The confirm menu will appear.

4. When the confirm menu appears on your screen "Cancel" is highlighted as default. Use the ◀ button to highlight "Enter".

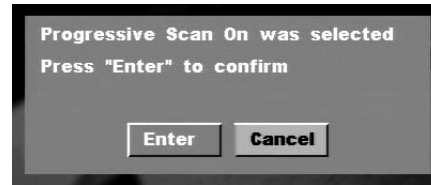

5. Pressing ENTER will set this unit to progressive scan mode.

Notes:

- If you set Progressive Scan to ON in error, you must reset the DVD+VCR. Press STOP (■) and hold it for more than five seconds before releasing it. The video output will be restored to the standard setting, and a picture will once again be visible on a conventional analog TV or monitor.
- Do not turn off this DVD+VCR while the "PROGRESSIVE SCAN MODE" message is displayed on the TV screen.

Video Output

Set this unit's Video Output options according to the TV connection type.

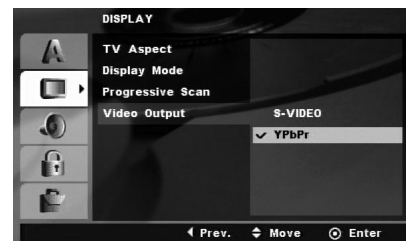

S-VIDEO : When your TV is connected with the S-VIDEO OUT jack on this unit.

YPbPr : When your TV is connected with the COMPONENT/PROGRESSIVE SCAN VIDEO OUT jacks on this unit.

Initial Settings - DVD (Continued)

AUDIO

Each DVD disc has a variety of audio output options. Set this unit's AUDIO options according to the type of audio system you use.

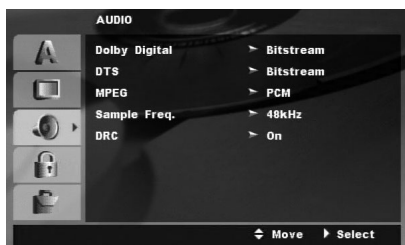

Dolby Digital / DTS / MPEG **DVD**

Bitstream: Select "Bitstream" if you connect the DVD+VCR's DIGITAL AUDIO OUT jack to an amplifier or other equipment with a Dolby Digital, DTS or MPEG decoder.

PCM (for Dolby Digital / MPEG): Select when connected to a two-channel digital stereo amplifier. DVDs encoded in Dolby Digital or MPEG will be automatically downmixed to two-channel PCM audio.

Off (for DTS): If you select "Off", the DTS signal is not output through the DIGITAL AUDIO OUT jack.

Sample Freq. (Frequency) **DVD**

If your receiver or amplifier is NOT capable of handling 96 kHz signals, select 48 kHz. When this choice is made, this unit automatically converts any 96 kHz signals to 48 kHz so your system can decode them.

If your receiver or amplifier is capable of handling 96 kHz signals, select 96 kHz. When this choice is made, this unit passes each type of signal through without any further processing.

Check the documentation for your amplifier to verify its capabilities.

DRC (Dynamic Range Control) **DVD**

With the DVD format, you can hear a program's soundtrack in the most accurate and realistic presentation possible, thanks to digital audio technology. However, you may wish to compress the dynamic range of the audio output (the difference between the loudest sounds and the quietest ones). This allows you to listen to a movie at a lower volume without losing clarity of sound. Set DRC to On for this effect.

OTHERS

The PBC, Auto Play, and B.L.E. settings can be changed.



PBC **VCD**

Set Playback Control (PBC) to On or Off.

On: Video CDs with PBC are played according to the PBC.

Off: Video CDs with PBC are played the same way as Audio CDs.

Auto Play **DVD**

You can set up the DVD+VCR so a DVD disc automatically starts playing whenever the DVD is inserted. If Auto Play mode is set to On, this DVD player will search for title that has the longest playback time and then play back the title automatically.

On: Auto Play function is active.

Off: Auto Play function is not active.

Note:

The Auto Play function may not work for some DVDs.

B.L.E. (Black Level Expansion)

To select the black level of playback pictures. Set your preference and monitor's ability.

On: Expanded grey scale. (0 IRE cut off)

Off: Standard grey scale. (7.5 IRE cut off)

Initial Settings - DVD (Continued)

LOCK (Parental Control)

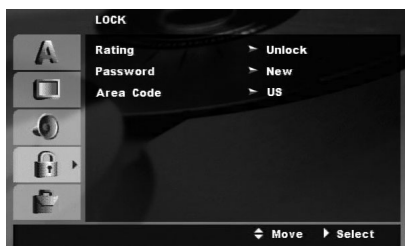

Rating **DVD**

Some movies contain scenes that may not be suitable for children to view. Many of these discs contain parental control information that applies to the complete disc or to certain scenes on the disc. Movies and scenes are rated from 1 to 8, depending on the area. DVD video discs may or may not respond to the parental control setting if the Area code of the disc is set wrongly. Some discs offer more suitable scenes as an alternative. Ratings are area dependent.

The parental control feature allows you to block access to scenes below the rating you input, thereby preventing your children from being able to view material you believe is unsuitable.

1. Select "Rating" on the LOCK menu then press ►.
2. To access the Rating, Password and Area Code features, you must input the 4-digit security code you created.

If you have not yet entered a security code you are prompted to do so. Input a 4-digit code and press ENTER. Enter it again and press ENTER to verify. If you make a mistake before pressing ENTER, press CLEAR.

3. Select a rating from 1 to 8 using the ▲ / ▼ buttons.
1-8: Rating one (1) has the most restrictions and rating eight (8) has the least restrictive.
Unlock : If you select unlock, parental control is not active and the disc plays in full.
4. Press ENTER to confirm your rating selection, then press SETUP to exit the menu.
5. Press OPEN/CLOSE (▲) to activate parental control.

Note:

If you set a rating for the player, all disc scenes with the same rating or lower are played. Higher rated scenes are not played unless an alternate scene is available on the disc. The alternative must have the same rating or a lower one. If no suitable alternative is found, playback stops. You must enter the 4-digit password or change the rating level in order to play the disc.

Password (Security Code)

You can enter or change password.

1. Select "Password" on the LOCK menu then press ►.
2. Follow step 2 as shown left column (Rating).
To change the password, select the "Change", press ENTER and input the new 4-digit code then press ENTER. Input it again to verify.
3. Press SETUP to exit the menu.

If you forget your Security Code

If you forget your security code you can clear it using the following steps:

1. Press SETUP to display the Setup menu.
2. Input the 6-digit number "210499" and the security code is cleared.
3. Enter a new code as described above.

Area Code **DVD**

Enter the Area Code whose standards were used to rate the DVD video disc, based on the list in the reference chapter (see page 37).

1. Select "Area Code" on the LOCK menu then press ►.
2. Follow step 2 as shown left (Rating).
3. Select the first character using ▲ / ▼ buttons.
4. Press ► and select the second character using ▲ / ▼ buttons.
5. Press ENTER to confirm your area code selection.



Operation with tape

This chapter describes how to operate the VCR and DVD.

VCR Tape Playback

Press the **VCR** button to select the device to be operated.

Basic Instructions

1. Turn on the TV.
2. Tune the TV to the DVD+VCR output channel (CH 3 or 4) or if a direct VIDEO/AUDIO connection is made between the DVD+VCR and the TV, set the TV's source selector to VIDEO.
3. Insert a pre-recorded video cassette.
The  indicator lights and the DVD+VCR powers on automatically.
4. If the  (TIMER) indicator in the display window is lit press POWER (I/⏻) once.
5. If a tape without a safety tab is inserted the unit starts playback automatically.
If not, press PLAY (▶).
6. Press STOP (■) to stop playback. If the tape reaches the end before you press STOP (■) the DVD+VCR automatically stops, rewinds and ejects the tape.

Note:

It is not necessary to select the tape speed for playback because it is automatically selected by the DVD+VCR. Also, during playback the TV/VCR selector switches to VCR mode automatically.

Auto Tracking

Automatic tracking adjusts the picture to remove snow or streaks and beings when:

- When the ATR (Auto Tracking) button is pressed.
- A tape is played for the first time.
- The tape speed (SP, LP, SLP) changes.
- Streaks or snow appear due to scratches on the tape.

Manual Tracking

To manually adjust the tracking use the CH/TRK (▲/▼) buttons on the remote control or CH (▲/▼) on the front panel during playback.

Notes:

- Vertical jitter requires a very fine adjustment.
- Tracking is automatically reset to normal when the tape is ejected or the power cord is unplugged for more than 3 seconds.

Search

This function lets you visually search for a tape section in either direction: forward and reverse. During the high-speed picture search modes, the audio is muted and horizontal lines (noise bars) appear. Also, a short time is needed to stabilize the tape speed when re-entering the PLAY mode so slight interference may be observed during this time.

To search:

1. Press REW (◀◀) or FWD (▶▶) during playback.
2. To return to playback, press PLAY (▶).

Still Picture and Frame-by-Frame Playback

1. Press PAUSE/STEP (||/||▶) during playback.
A still picture appears on the TV screen and the audio is muted.
2. If the still picture vibrates vertically, stabilize it by using CH/TRK (▲/▼) on the remote control.
3. Press PAUSE/STEP (||/||▶) repeatedly to advance the video picture one frame at a time.
4. To return to playback, press PLAY (▶).

Note:

After 5 minutes in STILL mode the DVD+VCR stops to protect the tape and video heads.

Operation with tape (Continued)

Slow Motion

1. While in playback or still mode, press SLOW (▶▶). The tape is played at a speed 1/19 times slower than the normal speed.
2. Use CH/TRK (▲/▼) on the Remote Control if necessary to adjust the tracking.
3. To return to the normal speed, press PLAY (▶).

Notes:

- During slow motion, audio is muted and horizontal lines (noise bars) may appear on the TV screen. This is normal.
- After 3 minutes in SLOW MOTION mode the DVD+VCR goes back to PLAY mode to protect the tape and video heads.

CM SKIP (Commercial Skip)

This feature is useful for skipping commercials or short program segments.

1. Press CM SKIP in playback mode. The DVD+VCR performs a fast forward picture search through 30 seconds of recording.
2. Press CM SKIP again to extend the search time by an addition 30 seconds. The maximum search time is 3 minutes.
3. When the search is complete, the DVD+VCR goes into playback mode automatically.

Blank Search

The Blank Search enables you to locate the end of any recording. Whenever a recording creates, a blank content is recorded on the tape. Press BLANK SEARCH during playback or in the stop mode and rapidly advanced to find blank content. To find next blank content, press BLANK SEARCH again.

VISS (VHS Index Search System)

The VHS INDEX SEARCH SYSTEM enables you to locate the beginning of any recording made on this DVD+VCR. Whenever a recording begins, an invisible INDEX mark is recorded on the tape.

VISS Scan

VISS SCAN lets you search out each VISS mark on the recorded tape and play 5 seconds before advancing to the next VISS mark.

1. Insert a cassette tape that has VISS signals marked.
2. Press the VISS once during PLAYBACK or STOP mode. The "SCH --" indicator will appear in the display window.
3. Press either REW (◀◀) or FWD (▶▶). The VISS SCAN will start. The tape will be rewound or rapidly advanced to the next signal marked. The tape will be played back for approximately 5 seconds, and then rewound or rapidly advanced to the next VISS signal. Press VISS or STOP button to stop the VISS SCAN mode.
4. At the desired program, press the PLAY (▶). Normal playback of that program will begin.

VISS Search

You can locate the desired program and play it back automatically by designating the number of its VISS signal. Up to the 99th VISS signal from the preset position on the tape can be located.

1. Press the VISS button once during PLAYBACK or STOP mode. The "SCH --" indicator will appear in the display window.
2. Enter the number of VISS signals you wish to skip. Up to 99 signals may be skipped from any given position on the tape.
3. Press either REW (◀◀) or FWD (▶▶) once. The SCH 02 (for example) message appears in the display window. When the desired VISS signal is found, playback begins automatically. If the end of the tape is reached during forward VISS search, the DVD+VCR will automatically stop, rewind, eject, and turn itself off.

Operation with tape (Continued)

VHS Hi-Fi Stereo / MTS

Broadcast

This DVD+VCR is equipped with the VHS Hi-Fi audio sound system for recording and playback. The information below gives a brief description of Hi-Fi audio and how to record and play a tape in the Hi-Fi audio mode.

Hi-Fi Stereo Audio Sound

A stereo TV with AUDIO/VIDEO input jacks or a stereo audio system is required for true stereo playback. To experience the full and rich stereo sound available with Hi-Fi recorded tapes, we recommend the connection of this unit to a home stereo audio system.

1. Set the AUDIO MODE option to HI-FI on the SETUP menu .



2. Set the AUDIO OUTPUT option to STEREO so that the left channel sound (L) is heard from the left speaker and the right channel sound (R) is heard from the right speaker.

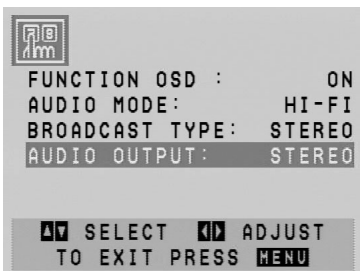

The other options are (LEFT) POSITION, which results in the left channel sound (L) being heard from both speakers or (RIGHT) POSITION, which results in the right channel sound (R) being heard from both speakers.

3. Insert a cassette and press PLAY (▶).

MTS (Multi-Channel TV Sound)

This DVD+VCR can decode MTS stereo and bilingual (SAP) off-the-air broadcast sound signals. It also decodes stereo TV sound from local cable companies as long as they operate on assigned cable frequencies and use the EIA-recommended MTS stereo/bilingual TV sound system.

Multichannel TV Sound Indicator (MTS)

When you press ENTER one or both of the indicators appears on the TV Screen.

STEREO

The DVD+VCR can record in stereo onto the VHS Hi-Fi audio tracks when the BROADCAST TYPE option is in the STEREO position. The DVD+VCR can also record mono audio onto the mono audio track.

SAP

Some stations transmit a Second Audio Program, which is used for a second language or additional information.

STEREO/SAP

Use the BROADCAST TYPE option to select the desired recording mode (STEREO or SAP).

Operation with tape (Continued)

VCR Tape Recording

Basic Instructions

1. Turn on the DVD+VCR and TV.
2. Tune the TV to the DVD+VCR output channel (CH 3 or 4) or if a direct VIDEO/AUDIO connection is made between the DVD+VCR and the TV, set the TV's source selector to VIDEO.
3. Insert a video cassette with the safety tab intact.
4. Select the desired channel using CH/TRK (▲/▼).
5. If you are recording from another source via audio/video input jacks (at the rear or front panel), select LINE1 or LINE2 using INPUT SELECT.
6. Set the desired recording speed (SP or SLP) by pressing SP/SLP. This DVD+VCR is not designed to record in LP mode.
7. Set the MTS mode (STEREO or SAP). Set the BROADCAST TYPE option to SAP if applicable.
8. Press REC/OTR and recording starts. The REC indicator appears in the display window. If a cassette with no safety tab is loaded, the cassette is ejected.
9. Press STOP (■) to stop recording. If the tape reaches the end before STOP (■) is pressed, the DVD+VCR stops, rewinds and ejects the tape.

Tip:

Use PAUSE/STEP (||/||▶) for best results when making changes while recording. For example, if you want to change channels while recording, first press PAUSE/STEP (||/||▶) to put the unit in pause mode, select the desired channel on the DVD+VCR, and then press PAUSE/STEP (||/||▶) again to resume recording.

Notes:

- During the VCR recording mode, you cannot change to the DVD mode.
- The unauthorized recording, use, distribution, or revision of television programs, videotapes, DVDs and other materials, is prohibited under the Copyright Laws of the United States and other countries, and may subject you to civil and/or criminal liability.

To pause the recording

1. Press PAUSE/STEP (||/||▶) to pause the tape during recording. The REC indicator flashes in the display window.
2. When you want to continue recording, press PAUSE/STEP (||/||▶) or press REC/OTR. After 5 minutes in PAUSE mode, the DVD+VCR stops automatically to protect the tape and the video heads.

To record one TV program while watching another

1. Press TV/VCR to select the TV mode during recording. The TV indicator appears.
2. Using the TV, select the channel to be viewed.

Timer Recording

For unattended recording, you must input the channels to be recorded and the starting and ending times.

Things to know before starting

If you try to set the program timer before setting the clock, "PLEASE SET THE CLOCK" appears for a moment and then CLOCK menu appears on the TV screen. Set the time and date before proceeding.

1. Turn on the DVD+VCR and the TV.
2. Be sure the TV is set to the DVD+VCR output channel (3 or 4).
3. Make sure the TUNING BAND in the TUNING menu is set appropriately (TV or CATV).
4. Press VCR MENU and the MAIN menu appears.
5. Use ▲/▼ to choose the PROGRAM menu and press ENTER.

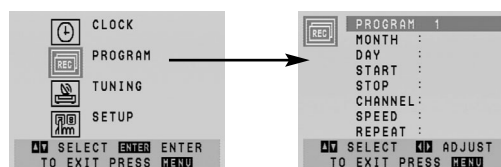

If eight programs are already entered, the FULLY PROGRAMMED message appears for a moment and then PROGRAM 1 appears on the TV screen.

6. Use the ▲/▼ buttons to switch between the program options, and the ◀/▶ buttons to input the program information:

Input the month, day, start and stop times of the program you want to record.

Operation with tape (Continued)

CHANNEL: Select a TV channel, LINE1 or LINE2. If you have CABLE TV and use a cable box (converter) you must set the channel to match the cable box output channel (usually CH 3 or 4). Change channels on the cable box instead of with the DVD+VCR. If you use a cable converter, you can program multiple recordings only on the converter box output channel. This is because the converter determines what channel you view through your DVD+VCR.

SPEED: AUTO mode determines how much tape is left and switches the speed from SP to SLP if it is necessary to complete recording the program. If this occurs there could be some picture and sound distortion at the point where the speed changes.

REPEAT: To record up to 8 programs on a certain day of every week select WEEKLY. To record up to 8 programs at the same time Monday through Friday select DAILY. Otherwise select ONCE.

7. Press VCR MENU and the program is memorized by the DVD+VCR.
8. Additional programs may be entered by repeating steps 1-7.
9. Ensure you insert a tape with the record safety tab intact before the first programmed time.
10. Press STOP (■) to end timer recording.

Notes:

- If you make a mistake or want to change a setting, use ▲ to select the option and correct it using ◀/▶.
- If the program preset time is past, the "PAST TIME PROGRAMMED" message appears on the TV screen. Return to the incorrect program and program it with the correct time.
- If you enter a past date, the timer recording will be performed on that date of the next year.
- If the power fails or the DVD+VCR is unplugged the clock and timer settings are kept in memory for only 3 seconds. Otherwise you must reset the clock and timer.
- If the tape indicator is blinking, no tape is loaded.
- When you are playing DVD at programmed Recording time, the DVD+VCR automatically change to VCR mode and start recording.
- The DVD+VCR will automatically power off when Timer Recording ends.
- The unauthorized recording, use, distribution, or revision of television programs, videotapes, DVDs and other materials, is prohibited under the Copyright Laws of the United States and other countries, and may subject you to civil and/or criminal liability.

Checking or Erasing the Timer Program

Programming can be checked whenever the DVD+VCR is turned on.

1. Press VCR MENU and the MAIN menu appears.
2. Use ▲/▼ to choose the PROGRAM menu and press ENTER.

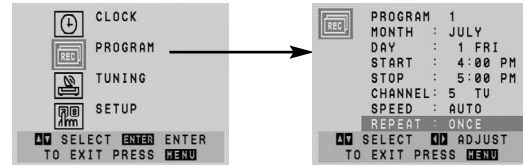

3. Use ◀/▶ to select a program you want to check or erase. To erase the program, press CLEAR.
4. Press VCR MENU to return to the TV screen.

Program Priority

If the recording start and end times of preset programs overlap on the same day (see the example), the second program is not recorded until the first is finished.

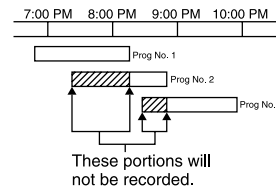

In this example, the first part of program numbers 2 and 3 are not recorded.

Operation with tape (Continued)

One-touch Timer Recording

With this feature you can record for a preset length without using the program timer.

1. Turn on DVD+VCR and the TV.
2. Be sure the TV is tuned to the DVD+VCR output channel (CH 3 or 4). If a direct VIDEO/AUDIO connection is made between the DVD+VCR and the TV, set the TV's source selector to VIDEO.
3. Insert a video cassette with the safety tab intact.
4. Select the desired channel using CH/TRK (▲/▼) or the number buttons (0-9). The channel number appears on the TV screen. If you are recording from another source via audio/video input jacks, select LINE1 (rear jacks) or LINE2 (front jacks) by using INPUT SELECT.
5. Set the desired recording speed (SP or SLP) using SP/SLP. The tape speed appears on the TV screen.
6. Press REC/OTR twice. The menu appears on the TV screen, recording starts, and the Ⓢ (TIMER) indicator lights.

ONE TOUCH TIMER RECORD	
CHANNEL	7
SPEED	SP
START LENGTH	NOW 0H30M

7. Press REC/OTR repeatedly to select the recording time length. Each time you press this button the recording time increases 30 minutes (up to 9 hours). At the end of the recording, the DVD+VCR will stop recording and shut off. If you set the time to 0H00M, the DVD+VCR goes into the normal recording mode. Press STOP (■) to stop the recording.

Note:

- During One-touch Timer Recording, you cannot change the channel on the DVD+VCR.
- During the VCR recording mode, you cannot change to the DVD mode.
- The unauthorized recording, use, distribution, or revision of television programs, videotapes, DVDs and other materials, is prohibited under the Copyright Laws of the United States and other countries, and may subject you to civil and/or criminal liability.

Checking the Recording Time

Press REC/OTR once to check the recording time. The recalled setting automatically returns to the TV screen after 6 seconds.

Extending the Recording Time

The recording time can be extended anytime by pressing REC/OTR. Subsequent presses result in advancing the recording time by 30-minute increments.

Note:

If you press PAUSE/STEP (||/||▶) during instant timer recording, the instant timer recording is cancelled.

Recording from External Components

You can record from an external component, such as a camcorder or VCR, connected to any of the DVD+VCR's external inputs.

1. Make sure that the component you want to record from is connected properly to the DVD+VCR. See page 14.
2. Press INPUT SELECT repeatedly to select the external input to record from.
 - LINE1 (L1): Audio/Video Input mounted on back panel.
 - LINE2 (L2): Audio/Video Input mounted on front panel.
3. Load a recordable tape.
4. Set a recording mode (SP or SLP) as necessary by pressing SP/SLP repeatedly.
5. Play the tape or disc in the external component. If you have a TV attached to your DVD+VCR, you can see the video playing.
6. Press REC/OTR once to start recording. The REC indicator lights in the display window.
7. Press STOP (■) to stop recording.

Notes:

- Before recording, confirm the recording start position.
- If your source is copy-protected using CopyGuard, you will not be able to record it using this unit. See Copyright on page 7 for more details.
- To record for a fixed length of time, see One-touch Timer Recording.

Operation with tape (Continued)

Copying from DVD to VCR

You can copy the contents of a DVD to a VHS tape.

1. Insert the disc you wish to copy into the DVD deck and close the disc tray.
2. Insert a blank VHS video tape into the VCR deck.
3. Find the place on the DVD from which you want to start dubbing using the PLAY, FWD, REW and PAUSE functions.
For best results, pause playback at the point from which you want to record.
4. Press the COPY button on the front panel or REC/OTR on the Remote Control. The DVD goes into PLAY mode and the VCR goes into RECORD mode. If the DVD disc menu appears, you may need to press PLAY (▶) manually to begin copying.
5. When the DVD is finished playing, press STOP (■) to end copying.

Notes:

- If the DVD you are attempting to copy is copy protected, you will not be able to copy the disc. It is not permitted to copy Macrovision encoded DVDs (or Discs). "LOCK" is displayed in the display window.
- You must stop the copy process manually when the DVD movie ends, or the unit may replay and record over and over again.
- When you stop the DVD playback during copying, the recording on VCR is stopped automatically.
- The unauthorized recording, use, distribution, or revision of television programs, videotapes, DVDs and other materials, is prohibited under the Copyright Laws of the United States and other countries, and may subject you to civil and/or criminal liability.

On-Screen Display - VCR

Some of these functions will be displayed every time the DVD+VCR is operated.

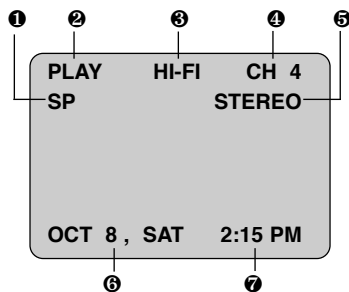

- | | |
|----------------------|---|
| ❶ TAPE SPEED DISPLAY | ❷ STEREO/SAP DISPLAY
(MONO is not displayed) |
| ❸ FUNCTION DISPLAY | ❸ DATE DISPLAY |
| ❹ HI-FI DISPLAY | ❹ CLOCK/COUNT/REMAIN
DISPLAY |
| ❺ CHANNEL DISPLAY | |

Each press of the ENTER changes the TV screen in the following sequence.

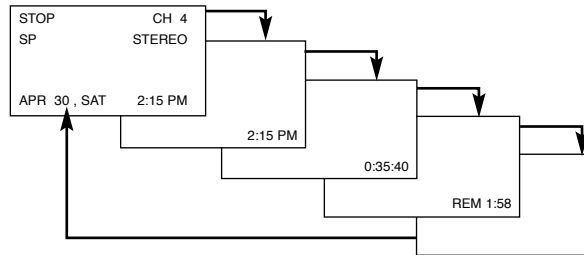

Real-Time Counter

If a tape with contents recorded on it is inserted into the DVD+VCR, the real-time counter shows length of the tape running in hours, minutes, and seconds.

Press CLOCK/COUNTER to select the real-time counter display. Every press of CLOCK/COUNTER changes the TV screen as illustrated below.

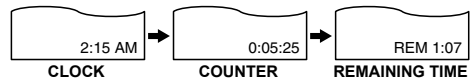

Counter Memory

This feature is useful if there is a section of tape you want to view immediately after recording or if you want to return to the same point several times.

1. Begin recording or playing a tape.
2. Press CLOCK/COUNTER until the real-time counter is displayed on the TV screen.
3. At the point that you want to locate later, reset the real-time counter to "0:00:00" by pressing CLEAR.
4. Continue to play or record.
5. Press STOP (■) when recording or playback finishes.
6. Press REW (◀◀). The tape automatically stops when the tape counter returns to about "0:00:00".

Tape Remaining

This function displays the amount of time remaining on the tape during recording or playback. Press CLOCK/COUNTER repeatedly until the REM indicator displays on the TV screen during recording or playback. The remaining tape length may not be displayed correctly depending on the condition of the tape and the kind of the tape (T-140, T-160, or T-210 etc.).

Notes:

- The function displays can be seen displayed on the TV screen for 5 seconds.
- The clock (or tape counter, tape remaining) mode will be displayed until you press **ENTER**.
- The tape counter and the remaining tape length indicator appear only when a cassette is inserted. Also, the remaining tape length indicator appears after any tape operation.

Operation with tape (Continued)

Additional VCR Information

- During manual recording, timer recording, One-touch Timer Recording, playback, or fast forward modes, the DVD+VCR automatically starts rewinding the tape at the end of the tape. The cassette stops at the beginning of the tape and is ejected.
- After you have finished using the DVD+VCR, rewind, eject, and remove the cassette. Place the cassette in its protective sleeve to protect it from dust. It is not necessary to rewind the cassette before removing it, but if you do, it is ready to play or record the next time you use it.
- Be sure the DVD+VCR channel selector is on the correct channel you wish to record. The channel that is being recorded can always be checked by setting the television on the DVD+VCR channel (CH 3 or 4) and pressing the TV/VCR to turn the DVD+VCR's TV indicator off.
- Do not attempt to hook up more than one television set to the DVD+VCR for either recording or playback.

VCR Auto Play System

This DVD+VCR features automatic playback.

When you load a tape with the safety tab removed the following occurs:

- The Output Source is changed to VCR mode automatically.
- The power turns on automatically and playback begins.
- At the end of the tape, the DVD+VCR stops, then rewinds.
- The tape is ejected after rewinding and the turns itself off automatically.

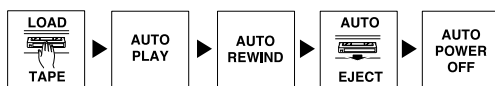

Note:

Auto power off does not function during regular DVD play mode. (DVD+VCR power stays on.)

S-VHS Quasi Playback (SQPB)

- This DVD+VCR can play back S-VHS recorded tapes, however, it cannot make recordings using S-VHS format tapes.
- SQPB is an abbreviation for S-VHS Quasi Playback.

Easy Information

If the Extended Data Service (XDS) signals are provided along with normal TV signal in your area or during playback of a tape recorded with Extended Data Service (XDS) signals, the station ID, program title, and program details are shown on the TV screen. When viewing a channel with Extended Data Service (XDS) signals, press **ENTER** and the station ID will appear on the TV screen. Press **ENTER** again and the program details will appear on the TV screen.

When viewing a tape recorded with Extended Data Service (XDS) signals, press **ENTER** twice and the program title and program details will appear on the TV screen.

Program Details

LENGTH: Indicates the run length of a program.

TIME REMAINING: Indicates the remaining time of a program.

RATING: Indicates the rating of the current program (N/A, G, PG, PG-13, R, NC-17, X and Not Rated). The rating N/A means that the motion picture ratings are not applicable to this program.

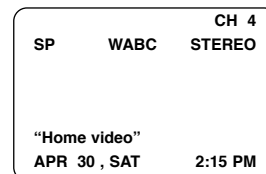

Easy Information Screen
(Station ID)

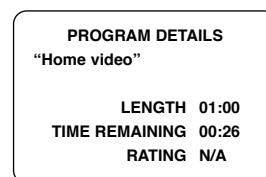

Easy Information Screen
(Program details)

Operation with DVD and Video CD

Playback Setup

1. Turn on the TV and select the video input source connected to the DVD+VCR.
2. Turn on the audio system (if applicable) and select the input source connected to the DVD+VCR.
3. Press OPEN/CLOSE (▲) to open the disc tray and load your chosen disc in the tray, with the playback side down.
4. Press OPEN/CLOSE (▲) to close the tray. Playback starts automatically. If playback does not start, press PLAY (▶).
In some cases, the disc menu might appear instead.
5. To stop the playback, press STOP (■).
The unit records the stopped point, depending on the disc. "II" appears on the screen briefly. Press PLAY (▶) to resume playback (from the scene point). If you press STOP (■) again or unload the disc ("■" appears on the screen.), the unit will clear the stopped point.
Press OPEN/CLOSE (▲) to remove the disc.
Press OPEN/CLOSE (▲) to close disc tray or press POWER (I/⏻), the disc tray closes automatically and unit turns off.

If a menu screen is displayed

The menu screen may be displayed first after loading a DVD or Video CD which offer a menu.

DVD

Use the ◀ ▶ ▲ ▼ buttons to select the title/chapter you want to view, then press ENTER to start. Press TOP MENU or MENU to return to the menu screen.

VCD

Use the number buttons to select the track you want to view and press RETURN (↵) to return to the menu screen. Menu settings and operating procedures may differ. Follow the instructions on each menu screen. You also may set PBC to Off (See "PBC" on page 19).

Notes:

- If parental control is set and the disc is not within the rating settings you must input the password. (See "LOCK" on page 20).
- DVDs may have a region code. Your player will not play discs that have a region code different from your player. The region code for this player is 1 (one)

General Features

Notes:

Unless stated otherwise, all operations described use the remote control. Some features may also be available on the Setup menu.

Moving to another TITLE **DVD**

When a disc has more than one title, you can move to another title. Press DISPLAY and select desired title by using number (0-9) or ◀ / ▶ then press ENTER to move to another title.

Moving to another CHAPTER / TRACK

DVD **VCD**

When a title on a disc has more than one chapter or a disc has more than one track, you can move to another chapter/track as follows:

- Press SKIP (▶▶ or ◀◀) briefly during playback to select the next chapter/track or to return to the beginning of the current chapter/track.
- Press SKIP (◀◀) twice in quick successions to step back to the previous chapter/track.
- To go directly to any chapter during DVD playback, press DISPLAY and press ▲ / ▼ to select the chapter/track icon. Input the chapter/track number (0-9) or use ◀ / ▶, then press ENTER.

Note:

On a Video CD with PBC, you must set PBC to Off on the setup menu to use this function (See "PBC" on page 19).

Slow Motion **DVD** **VCD**

1. Press SLOW (⏪) during playback or still mode. The DVD+VCR will now go into SLOW mode.
2. Use SLOW (⏪) to select the required speed: ⏪ 1/7, ⏪ 1/6, ⏪ 1/4, or ⏪ 1/2 (forward).
3. To exit Slow Motion mode, press PLAY (▶).

Note:

Slow motion playback in reverse is not possible.

Operation with DVD and Video CD (Continued)

Still Picture and Frame-by-Frame Playback

DVD VCD

1. Press PAUSE/STEP (||/II▶) during playback. Advance the picture frame-by-frame by pressing PAUSE/STEP (||/II▶) repeatedly.
2. To exit still motion mode, press PLAY (▶).

Search **DVD VCD**

1. Press REW (◀◀) or FWD (▶▶) during playback.
2. Press REW (◀◀) or FWD (▶▶) repeatedly to select the required speed :
DVD disc; X2, X4, X16 or X100
Video CD; X2, X4, X8
3. To exit SEARCH mode, press PLAY (▶).

Time Search **DVD VCD**

To start playing at any chosen time on the disc:

1. Press DISPLAY during playback. The time search box shows the elapsed playing time.
2. Press ▲ / ▼ to select the time clock icon and “-:-:-” appears.
3. Input the required start time in hours, minutes, and seconds from left to right. If you enter the wrong numbers, press CLEAR to remove the numbers you entered. Then input the correct numbers.
4. Press ENTER to confirm. Playback starts from the selected time.

Note:

On a Video CD with PBC, you must set PBC to Off on the setup menu to use this function (See “PBC” on page 19).

Marker Search **DVD VCD**

To enter a Marker 

You can start playback from up to nine memorized points. To enter a marker, press MARKER at the desired point on the disc. The Marker icon appears on the TV screen briefly. Repeat to enter up to nine markers.

To Recall or Clear a Marked Scene 

1. During disc playback, press SEARCH. The marker search menu appears on the screen.
2. Within 10 seconds, press ◀ / ▶ to select a marker number that you want to recall or clear.
3. Press ENTER and playback starts from the marked scene. Or, Press CLEAR and the marker number is erased from the list.
4. You can play any marker by inputting its number on the marker search menu.

Repeat **DVD VCD**

You can repeat a title/chapter/all/track on a disc. Press REPEAT during playback to select a desired repeat mode.

DVD Video Discs - Repeat Chapter / Title / Off

- Chapter: repeats the current chapter.
- Title: repeats the current title.
- Off : does not play repeatedly.

Video CDs - Repeat Track / All / Off

- Track : repeats the current track
- All : repeats all the tracks on a disc.
- Off : does not play repeatedly.

Notes:

- On a Video CD with PBC, you must set PBC to Off on the setup menu to use this function (See “PBC” on page 19).
- If you press SKIP (▶▶) once during Repeat Chapter (Track) playback, the repeat playback cancels.

Repeat A-B **DVD VCD**

To repeat a sequence.

1. Press A-B RPT at your chosen starting point. “A - ” appears briefly on the TV screen.
2. Press A-B RPT again at your chosen end point. “A - B” appears briefly on the TV screen and the repeat sequence begins.
3. Press A-B RPT again to cancel.

Zoom **DVD VCD**

Use zoom to enlarge the video image.

1. Press ZOOM during playback or still playback to activate the Zoom function. The square frame appears briefly in the right bottom of the picture.
2. Each press of the ZOOM button changes the TV screen in the sequence:
100% size → 150% size → 200% size → 300% size → 400% size → 100% size.
3. Use the ◀ ▶ ▲ ▼ buttons to move through the zoomed picture.
4. To resume normal playback, press ZOOM repeatedly or CLEAR button.

Note:

Zoom may not work on some DVDs.

Operation with DVD and Video CD (Continued)

Changing the Audio Channel **VCD**

Press AUDIO repeatedly during playback to hear a different audio channel (Stereo, Left, Right).

Last Scene Memory **DVD** **CD** **VCD**

This player memorizes last scene from the last disc that is viewed. The last scene remains in memory even if you remove the disc from the player or switch off the player. If you load a disc that has the scene memorized, the scene is automatically recalled.

Note:

This player does not memorize the scene of a disc if you switch off the player before commencing to play the disc.

Instant Replay **DVD**

Press INSTANT REPLAY during playback and the disc will reverse picture search through 10 seconds of playback. And then the playback will start from the point again.

Screen Saver

The screen saver appears when you leave the DVD+VCR in Stop mode for about five minutes.

Special DVD Features

Checking the contents of DVD discs: Menus

DVDs may offer menus that allow you to access special features. To use the disc menu, press MENU. Input the corresponding number or use the ◀▶▲▼ buttons to highlight your selection. Then press ENTER.

Title Menu **DVD**

1. Press TOP MENU. If the current title has a menu, the menu appears on the screen. Otherwise, the disc menu may appear.
2. The menu offers features such as camera angles, spoken language and subtitle options, and chapters for the title.
3. Press TOP MENU to exit.

Disc Menu **DVD**

Press MENU and the disc menu is displayed. Press MENU again to exit.

Camera Angle **DVD**

If the disc contains scenes recorded at different camera angles, you can change to a different camera angle during playback. Press ANGLE repeatedly during playback to select a desired angle. Note that the number of the current angle appears on the display.

Tip:

The Camera Angle icon is displayed on the TV screen when alternate angles are available.

Changing the Audio Language **DVD**

Press AUDIO repeatedly during playback to hear a different audio language or audio track.

Subtitles **DVD**

Press SUBTITLE repeatedly during playback to see the different subtitle languages.

Note:

If there is no information, Ⓞ is displayed.

Operation with DVD and Video CD (Continued)

On-Screen Display - DVD

You can display the general playback status on the TV screen. Some items can be changed using the menu.



To use the on-screen display:

1. Press DISPLAY during playback.
2. Press ▲ / ▼ to select an item.
The selected item is highlighted.
3. Press ◀ / ▶ to change the setting. You can also use the number buttons if appropriate (e.g. inputting the title number). For some functions, press ENTER to execute the setting.

Notes:

- Some discs may not provide all of the features shown below.
- If no button is pressed for 10 seconds, the on-screen display disappears.
- If Ⓞ is displayed, action prohibited or not available.

Example: On-Screen Display during playing DVD Video

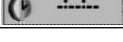
Items		Selection Method
Title Number		◀ / ▶, Numbers ENTER
Chapter Number		◀ / ▶, Numbers ENTER
Time search		Numbers, ENTER

Example: On-Screen Display during playing VCD

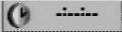
Items		Selection Method
Track Number (or PBC mode)		◀ / ▶, Numbers ENTER
Time search		Numbers ENTER

Maintenance and Service

Refer to the information in this chapter before contacting a service technician.

Handling the Unit

When shipping the unit

Please save the original shipping carton and packing materials. If you need to ship the unit, for maximum protection, re-pack the unit as it was originally packed at the factory.

Keeping the exterior surfaces clean

- Do not use volatile liquids such as insecticide spray near the unit.
- Do not leave rubber or plastic products in contact with the unit for a long period of time. since they leave marks on the surface.

Cleaning the unit

To clean the player, use a soft, dry cloth. If the surfaces are extremely dirty, use a soft cloth lightly moistened with a mild detergent solution.

Do not use strong solvents such as alcohol, benzene, or thinner, as these might damage the surface of the unit.

Maintaining the Unit

The DVD+VCR is a high-tech, precision device. If the optical pick-up lens and disc drive parts are dirty or worn, the picture quality could be diminished.

Depending on the operating environment, regular inspection and maintenance are recommended after every 1,000 hours of use.

For details, please contact your nearest authorized service center.

Playing an Audio CD or MP3/WMA Disc

The DVD+VCR can play MP3/WMA formatted recordings on CD-ROM, CD-R, or CD-RW discs.

Audio CD

Once you insert an audio CD a menu appears on the TV screen. Press ▲ / ▼ to select a track then press PLAY (▶) or ENTER and playback starts.



MP3 / WMA

1. Press ▲ / ▼ to select a folder, and press ENTER to see the folder contents.
2. Press ▲ / ▼ to select a track then press PLAY (▶) or ENTER. Playback starts.



ID3 TAG

- When playing a file containing information such as track titles, you can see the information by pressing DISPLAY. [Song, Artist, Album, Comment, Genre]
- If there is no information, "No ID3 TAG" appear on the menu screen.

Tips:

- If you are in a file list on the "MUSIC" menu and want to return to the Folder list, use the ▲ / ▼ to highlight  and press ENTER.
- To go directly to any track, input the track number (0-9).
- On a CD with MP3/WMA and JPEG you can switch MP3/WMA and JPEG. Press TOP MENU and "MUSIC" or "PHOTO" word on top of the menu is highlighted.

MP3 / WMA disc compatibility with this player is limited as follows:

- Sampling frequency: within 8 - 48 kHz (MP3), within 32 - 48kHz (WMA)
- Bit rate: within 32 - 320kbps (MP3), 48 - 384kbps (WMA)
- The player cannot read an MP3/WMA file that has a file extension other than ".mp3" / ".wma".
- CD-R physical format should be ISO 9660
- If you record MP3 / WMA files using software that cannot create a file system (eg. Direct-CD) it is impossible to playback MP3 / WMA files. We recommend that you use Easy-CD Creator, which creates an ISO 9660 file system.
- File names should have a maximum of 8 letters and must incorporate an .mp3 or .wma extension.
- They should not contain special letters such as / ? * : " < > | etc.
- The total number of contents on the disc should be less than 1500 files and 300 folders.

This DVD+VCR requires discs and recordings to meet certain technical standards in order to achieve optimal playback quality. Pre-recorded DVDs are automatically set to these standards. There are many different types of recordable disc formats (including CD-R containing MP3 or WMA files) and these require certain pre-existing conditions (see above) to ensure compatible playback. Because this area of technology is still evolving, Toshiba cannot guarantee that all recordable discs will produce optimal playback quality. The technical criteria set forth in this owner's manual are meant only as a guide.

Please be advised that you must obtain permission from the applicable copyright owners to download copyrighted content, including music files, in any format, including the MP3 and WMA formats, prior to the downloading thereof. Toshiba has no right to grant and does not grant permission to download any copyrighted content.

Microsoft, Windows Media, and the Windows Logo are either registered trademarks or trademarks of Microsoft Corporation in the United States and/or other countries.



Playing an Audio CD or MP3/WMA Disc (Continued)

Audio CD and MP3 / WMA Disc

Features

Pause **CD** **MP3** **WMA**

1. Press PAUSE/STEP (||/||▶) during playback.
2. To return to playback, press PLAY (▶) or press PAUSE/STEP (||/||▶) again.

Moving to another Track

CD **MP3** **WMA**

1. Press SKIP (▶▶| or |◀◀) briefly during playback to go to the next track or to return to the beginning of the current track.
2. Press SKIP (|◀◀) twice in quick successions to go back to the previous track.
3. You can play any track by inputting its number.

Repeat Track / All / Off **CD** **MP3** **WMA**

You can play a track/all on a disc.

1. Press REPEAT when playing a disc. The repeat icon appears.
2. Press REPEAT to select a desired repeat mode.
 - Track: repeats the current track.
 - All: repeats all the tracks on a disc.
 - Off (No display): does not play repeatedly.

Note:

If you press SKIP (▶▶|) once during Repeat Track playback, the repeat playback will be cancelled.

Search **CD** **MP3**

1. Press REW (◀◀) or FWD (▶▶) during playback.
2. Press REW (◀◀) or FWD (▶▶) repeatedly to select the required speed:
X2, X4 and X8 backward or forward.
3. To exit SEARCH mode, press PLAY (▶).

Random **CD** **MP3** **WMA**

1. Press RANDOM during playback. Random Playback begins immediately and "Random" appears on the menu screen.
2. To return to normal playback, press RANDOM repeatedly until "Random" disappears from the menu screen.

Tip:

By pressing SKIP (▶▶| or |◀◀) during random playback, the unit selects another track and resumes random playback.

Repeat A-B **CD**

1. To repeat a sequence during disc playback press A-B RPT at your chosen starting point. The Repeat icon and "A -" appear on the menu screen.
2. Press A-B RPT again at your chosen end point. The Repeat icon and "A-B" appear on the menu screen, and the sequence begins to play repeatedly.
3. To exit the sequence and return to normal play, press A-B RPT again. The Repeat icon disappears from the menu screen.

Playing an Audio CD or MP3/WMA Disc (Continued)

Programmed Playback

The program function enables you to store your favourite tracks from any disc in the player memory. A program can contain 30 tracks.

1. Insert a disc.
AUDIO CD or MUSIC menu appears.
2. Press PROGRAM.

The  mark will appear to the right of the word "Program" on the right side of the menu screen.







Audio CD Program Menu



MP3/WMA Program Menu

Note:

Press PROGRAM again, the  mark will disappear to exit the Program Edit mode.

3. Select a track on the "List", then press ENTER to place the selected track on the "Program" list. Repeat to place additional tracks on the list.
4. Press .
Select the track you want to start playing in the "Program" list.
5. Press PLAY () or ENTER to start. Playback begins in the order in which you programmed the tracks. Playback stops after all of the tracks on the "Program" list have played once.
6. To resume normal playback from programmed playback, select a track of AUDIO CD (or MUSIC) list and then press PLAY () or ENTER.

Note:

When you play the programmed track, the  mark will disappear then the program edit mode will disable.





Repeat Programmed Tracks

1. Press REPEAT when playing a disc. The repeat icon appears.
2. Press REPEAT to select a desired repeat mode.
 - Track: repeats the current track
 - All: repeats all the tracks on programmed list.
 - Off (No display): does not play repeatedly.





Note:

If you press SKIP () once during Repeat Track playback, the repeat playback will be cancelled.

Erasing a Track from "Program" List

1. During STOP mode, press PROGRAM and  mark will appear.
2. Use  /  /  to select the track that you wish to erase from the Program list.
3. Press CLEAR. Repeat to erase additional tracks on the list.

Erasing the Complete Program List

1. During STOP mode, press PROGRAM and  mark will appear.
2. Use  /  /  to select "Clear All" in the "Program" list, then press ENTER.

Note:

The programs are also cleared when the disc is removed.

Viewing a JPEG Disc

Using this DVD+VCR you can view discs with JPEG files.

1. Insert a disc and close the tray. The PHOTO menu appears on the TV screen.



2. Press ▲ / ▼ to select a folder, and press ENTER. A list of files in the folder appears. If you are in a file list and want to return to the previous Folder list, use the ▲ / ▼ buttons on the remote to highlight and press ENTER.
3. If you want to view a particular file, press ▲ / ▼ to highlight a file and press ENTER or PLAY (▶). The selected file will appear for viewing. While viewing a file, you can press STOP to move to the previous menu (PHOTO menu).

Tips:

- Information and user guidance regarding the current image is displayed in the lower part of the screen. You can toggle this bar on and off using RETURN (↵).
- There are three Slide Speed options : >>> (Fast), >> (Normal) and > (Slow). Use ▲ ▼ ◀ ▶ to highlight the Speed. Then, use ◀ / ▶ to select the option you want to use then press ENTER.
- On a disc with MP3/WMA and JPEG you can switch MP3/WMA and JPEG. Press TOP MENU and MUSIC or PHOTO word on top of the menu is highlighted.

Slide Show **JPEG**

Use ▲ ▼ ◀ ▶ to highlight the (Slide Show) then press ENTER.

Still Picture **JPEG**

1. Press PAUSE/STEP (⏸/⏹) during slide show. The player will now go into PAUSE mode.
2. To return to the slide show, press PLAY (▶) or press PAUSE/STEP (⏸/⏹) again.

Moving to another File **JPEG**

Press SKIP (▶▶ or ◀◀) or cursor (◀ or ▶) once while viewing a picture to advance to the next or previous file.

Zoom **JPEG**

Use zoom to enlarge the photo image. (see page 31)

To rotate picture **JPEG**

Press ▲ / ▼ during showing a picture to rotate the picture clockwise or counter clockwise.

JPEG disc compatibility with this player is limited as follows:

- Depending upon the size and number of JPEG files, it could take a long time for the DVD+VCR to read the disc's contents. If you don't see an on-screen display after several minutes, some of the files may be too large — reduce the resolution of the JPEG files to less than 5760 (Horizontal) x 3840 (Vertical) pixels and burn another disc.
- The total number of contents on the disc should be less than 1500 files and 300 folders.
- Some discs may be incompatible due to a different recording format or the condition of disc.
- Ensure that all the selected files have the ".jpg" extensions when copying into the CD layout.
- If the files have ".jpe" or ".jpeg" extensions, please rename them as ".jpg" file.
- File names without ".jpg" extension will not be able to be read by this DVD+VCR. Even though the files are shown as JPEG image files in Windows Explorer.

Language and Area Code List

Language Code List

Use this list to input your desired language for the following initial settings: Disc Audio, Disc Subtitle, Disc Menu.

Language	Code	Language	Code	Language	Code	Language	Code
Abkhazian	6566	Fiji	7074	Lingala	7678	Singhalese	8373
Afar	6565	Finnish	7073	Lithuanian	7684	Slovak	8375
Afrikaans	6570	French	7082	Macedonian	7775	Slovenian	8376
Albanian	8381	Frisian	7089	Malagasy	7771	Somali	8379
Ameharic	6577	Galician	7176	Malay	7783	Spanish	6983
Arabic	6582	Georgian	7565	Malayalam	7776	Sudanese	8385
Armenian	7289	German	6869	Maltese	7784	Swahili	8387
Assamese	6583	Greek	6976	Maori	7773	Swedish	8386
Aymara	6588	Greenlandic	7576	Marathi	7782	Tagalog	8476
Azerbaijani	6590	Guarani	7178	Moldavian	7779	Tajik	8471
Bashkir	6665	Gujarati	7185	Mongolian	7778	Tamil	8465
Basque	6985	Hausa	7265	Nauru	7865	Tatar	8484
Bengali, Bangla	6678	Hebrew	7387	Nepali	7869	Telugu	8469
Bhutani	6890	Hindi	7273	Norwegian	7879	Thai	8472
Bihari	6672	Hungarian	7285	Oriya	7982	Tibetan	6679
Breton	6682	Icelandic	7383	Panjabi	8065	Tigrinya	8473
Bulgarian	6671	Indonesian	7378	Pashto, Pushto	8083	Tonga	8479
Burmese	7789	Interlingua	7365	Persian	7065	Turkish	8482
Byelorussian	6669	Irish	7165	Polish	8076	Turkmen	8475
Cambodian	7577	Italian	7384	Portuguese	8084	Twi	8487
Catalan	6765	Japanese	7465	Quechua	8185	Ukrainian	8575
Chinese	9072	Javanese	7487	Rhaeto-Romance	8277	Urdu	8582
Corsican	6779	Kannada	7578	Rumanian	8279	Uzbek	8590
Croatian	7282	Kashmiri	7583	Russian	8285	Vietnamese	8673
Czech	6783	Kazakh	7575	Samoan	8377	Volapük	8679
Danish	6865	Kirghiz	7589	Sanskrit	8365	Welsh	6789
Dutch	7876	Korean	7579	Scots Gaelic	7168	Wolof	8779
English	6978	Kurdish	7585	Serbian	8382	Xhosa	8872
Esperanto	6979	Laothian	7679	Serbo-Croatian	8372	Yiddish	7473
Estonian	6984	Latin	7665	Shona	8378	Yoruba	8979
Faroese	7079	Latvian, Lettish	7686	Sindhi	8368	Zulu	9085

Area Code List

Choose a area code from this list.

Area	Code	Area	Code	Area	Code	Area	Code
Afghanistan	AF	Ethiopia	ET	Malaysia	MY	Saudi Arabia	SA
Argentina	AR	Fiji	FJ	Maldives	MV	Senegal	SN
Australia	AU	Finland	FI	Mexico	MX	Singapore	SG
Austria	AT	France	FR	Monaco	MC	Slovak Republic	SK
Belgium	BE	Germany	DE	Mongolia	MN	Slovenia	SI
Bhutan	BT	Great Britain	GB	Morocco	MA	South Africa	ZA
Bolivia	BO	Greece	GR	Nepal	NP	South Korea	KR
Brazil	BR	Greenland	GL	Netherlands	NL	Spain	ES
Cambodia	KH	Islands	HM	Netherlands Antilles	AN	Sri Lanka	LK
Canada	CA	Hong Kong	HK	New Zealand	NZ	Sweden	SE
Chile	CL	Hungary	HU	Nigeria	NG	Switzerland	CH
China	CN	India	IN	Norway	NO	Taiwan	TW
Colombia	CO	Indonesia	ID	Oman	OM	Thailand	TH
Congo	CG	Israel	IL	Pakistan	PK	Turkey	TR
Costa Rica	CR	Italy	IT	Panama	PA	Uganda	UG
Croatia	HR	Jamaica	JM	Paraguay	PY	Ukraine	UA
Czech Republic	CZ	Japan	JP	Philippines	PH	United States	US
Denmark	DK	Kenya	KE	Poland	PL	Uruguay	UY
Ecuador	EC	Kuwait	KW	Portugal	PT	Uzbekistan	UZ
Egypt	EG	Libya	LY	Romania	RO	Vietnam	VN
El Salvador	SV	Luxembourg	LU	Russian Federation	RU	Zimbabwe	ZW

Troubleshooting

Check the following guide for the possible cause of a problem before contacting service.

Symptom	Cause	Correction
No power.	<ul style="list-style-type: none"> The power cord is disconnected. 	<ul style="list-style-type: none"> Plug the power cord into the wall outlet securely.
The power is on, but the DVD+VCR does not work.	<ul style="list-style-type: none"> DVD or VCR button is not switched properly. 	<ul style="list-style-type: none"> Refer to page 7.
	<ul style="list-style-type: none"> No disc is inserted. No tape is inserted. 	<ul style="list-style-type: none"> Insert a disc or tape. (Check that the disc or tape indicator in the display window is lit.)
No picture.	<ul style="list-style-type: none"> The TV is not set to receive DVD+VCR signal output. 	<ul style="list-style-type: none"> Select the appropriate video input mode on the TV so the picture from the DVD+VCR player appears on the TV screen.
	<ul style="list-style-type: none"> The video cable is not connected securely. 	<ul style="list-style-type: none"> Connect the video cable into the jacks securely.
	<ul style="list-style-type: none"> Mismatch setting between TV and this unit. 	<ul style="list-style-type: none"> Select the correct Video Output in SETUP menu.
	<ul style="list-style-type: none"> Wrong connection. 	<ul style="list-style-type: none"> Check the connection.
No sound.	<ul style="list-style-type: none"> The equipment connected with the audio cable is not set to receive DVD+VCR signal output. 	<ul style="list-style-type: none"> Select the correct input mode of the audio receiver so you can listen to the sound from the DVD+VCR.
	<ul style="list-style-type: none"> The audio cables are not connected securely. 	<ul style="list-style-type: none"> Connect the audio cable into the jacks securely.
	<ul style="list-style-type: none"> The power of the equipment connected with the audio cable is turned off. 	<ul style="list-style-type: none"> Turn on the equipment connected with the audio cable.
	<ul style="list-style-type: none"> The AUDIO options are set to the wrong position. 	<ul style="list-style-type: none"> Set the AUDIO options to the correct position.
The playback picture is poor.	<ul style="list-style-type: none"> The disc is dirty. 	<ul style="list-style-type: none"> Clean the disc.
	<ul style="list-style-type: none"> The TV channels are not tuned in properly. 	<ul style="list-style-type: none"> Check tuning, carry out tuning again.
	<ul style="list-style-type: none"> Tape heads are dirty. 	<ul style="list-style-type: none"> Clean video heads.
	<ul style="list-style-type: none"> Tape is a rental or was recorded on another VCR. 	<ul style="list-style-type: none"> Use CH/TRK (+/-) for manual tracking adjustment while tape is playing.
	<ul style="list-style-type: none"> This unit can only output 525p Progressive scan picture. 	<ul style="list-style-type: none"> Make sure that your TV can support 525p Progressive scan picture or set Progressive scan to off.
The "PROGRESSIVE SCAN MODE" message remains to be displayed.	<ul style="list-style-type: none"> DVD+VCR was turned off while setting the Progressive scan mode. The Progressive Scan was set to "On" in the SETUP menu but is connected to a standard(analog) television with component video input. 	<ul style="list-style-type: none"> Press and hold the STOP button for more than 5 seconds.

Troubleshooting (Continued)

Symptom	Cause	Correction
The DVD+VCR does not start playback.	• An unplayable disc is inserted.	• Insert a playable disc. (Check the disc type and Regional code.)
	• The disc is placed upside down.	• Place the disc with the playback side down.
	• The disc is not placed within the guide.	• Place the disc on the disc tray correctly inside the guide.
	• The disc is dirty.	• Clean the disc.
	• The Rating level is set.	• Cancel the Rating function or change the rating level.
Video tape cannot be inserted.	• Is the cassette compartment empty?	• Eject the tape in.
No Hi-Fi sound	• Audio mode is not set properly.	• Select STEREO by repeatedly pressing AUDIO on the remote control.
The remote control does not work properly.	• There is an obstacle in the path of the remote control and this unit.	• Remove the obstacle.
	• The batteries in the remote control are exhausted.	• Replace the batteries with new ones.
	• The remote control is not pointed at the remote sensor of the DVD+VCR.	• Point the remote control at the remote sensor of the DVD+VCR.
	• The remote control is too far from the DVD+VCR.	• Operate the remote control within 23ft (7m).
	• This remote control use the same buttons for VCR and DVD functions (ex.PLAY).	• When using a VCR, first press the VCR button. When using a DVD, first press the DVD button.
Camcorder image is not shown.	• Camcorder is off.	• Turn camcorder on and operate properly.
Camcorder image via AV input to DVD+VCR is not shown on TV screen.	• DVD+VCR SOURCE SELECT is not set to LINE1 or LINE2.	• Press INPUT SELECT to select LINE input channel (LINE1 or LINE2).
Timer recording is not possible.	• Clock in DVD+VCR is not set to correct time.	• Set clock to correct time.
	• Timer has been programmed incorrectly.	• Reprogram Timer.
	• Ⓞ indicator light does not appear after programming timer.	• Reprogram Timer and turn DVD+VCR off to enable timer.

Specifications

General

Power requirements	120V, 60 Hz
Power consumption	16 W
Dimensions (approx.)	16.9" X 3.1" X 10.4" (430 X 78.5 X 265 mm) (w x h x d)
Weight (approx.)	9.24 lbs (4.2 kg)
Operating temperature	5°C to 40°C (41°F to 104°F)
Operating humidity	5 % to 90 %
Signal system	NTSC

Inputs

ANTENNA IN	75 ohms (VHF/UHF/CATV)
VHS VIDEO IN(LINE1, 2)	1 V (p-p) 75 ohms, sync negative, RCA jack x 2
VHS AUDIO IN(LINE1, 2)	-6.0 dBm more than 47 ohms, RCA jack (L, R) x 2

Outputs

VIDEO OUT	1 V (p-p) 75 ohms, sync negative
S-VIDEO OUT	(Y) 1.0 V (p-p), 75 ohms, negative sync, Mini DIN 4-pin x 1 (C) 0.286 V (p-p) 75 ohms
COMPONENT VIDEO OUT (PROGRESSIVE SCAN)	(Y) 1.0 V (p-p), 75 ohms, negative sync, RCA jack x 1 (Pb)/(Pr) 0.7 V (p-p), 75 ohms, RCA jack x 2
Audio output (digital audio)	0.5 V (p-p), 75 ohms, RCA jack x 1
Audio output (analog audio)	2.0 Vrms (1 KHz, 0 dB), 600 ohms, RCA jack (L, R) x 1
RF OUT	Channel 3 or 4 (Adjustable)

VCR Specifications

Head system	Four head helical scan azimuth system
Timer	12-hour display type with AM, PM
Tape speed	SP: 33.35 mm/sec, LP: 16.67 mm/sec, SLP: 11.12 mm/sec
Tape width	12.7 mm
Maximum recording time	SP: 2 HOURS (T-120), SLP: 6 HOURS (T-120)/8 HOURS (T-160)
Rewind time	About 3 minutes (T-120)
Channel coverage	VHF: 2-13, UHF: 14-69, CATV: 1-125 (4A, A-W, W+1 - W+84, A-5 - A-1)
Frequency range	20 Hz to 20 kHz
Signal-to-noise ratio	More than 43 dB
Dynamic range	More than 88 dB
Channel separation	More than 60 dB

DVD Specifications

Laser system	Semiconductor laser, wavelength 650 nm
Frequency response	DVD (PCM 96 kHz): 8 Hz to 44 kHz, DVD (PCM 48 kHz): 8 Hz to 22 kHz CD: 8 Hz to 20 kHz
Signal-to-noise ratio	More than 100 dB (ANALOG OUT jacks only)
Harmonic distortion	Less than 0.008%
Dynamic range	More than 95 dB (DVD/CD)

Accessories:

Video cable x 1, Audio cable (L/R) x 1, RF 75-ohm Coaxial Cable x 1, Remote control x 1, Batteries (R03/AAA) x 2

- This model complies with the above specifications.
- Designs and specifications are subject to change without notice.
- This model may not be compatible with features and/or specifications that may be added in the future.

Limited United States Warranty

Digital Audio Video ("DAV") Product - Exchange Warranty

Toshiba America Consumer Products, L.L.C. ("TACP") makes the following limited warranties to original consumers in the United States. THESE LIMITED WARRANTIES EXTEND TO THE ORIGINAL CONSUMER PURCHASER OR ANY PERSON RECEIVING THIS DAV PRODUCT AS A GIFT FROM THE ORIGINAL CONSUMER PURCHASER AND TO NO OTHER PURCHASER OR TRANSFEREE.

DAV PRODUCTS PURCHASED IN THE U.S.A. AND USED ANYWHERE OUTSIDE OF THE U.S.A., INCLUDING, WITHOUT LIMITATION, CANADA AND MEXICO, ARE NOT COVERED BY THESE WARRANTIES.

DAV PRODUCTS PURCHASED ANYWHERE OUTSIDE OF THE U.S.A., INCLUDING, WITHOUT LIMITATION, CANADA AND MEXICO, AND USED IN THE U.S.A., ARE NOT COVERED BY THESE WARRANTIES.

Limited Warranty

TACP warrants this DAV Product and its parts against defects in materials or workmanship for a period of ninety (90) days after the date of original retail purchase. DURING THIS PERIOD, TACP WILL EXCHANGE A DEFECTIVE DAV PRODUCT WITH A NEW OR REFURBISHED DAV PRODUCT WITHOUT CHARGE TO YOU. DURING THE PERIOD THAT COMMENCES ON THE DATE THAT IS NINETY ONE (91) DAYS AFTER THE DATE OF ORIGINAL RETAIL PURCHASE AND ENDS ON THE DATE THAT IS THREE HUNDRED SIXTY FIVE (365) DAYS AFTER THE DATE OF ORIGINAL RETAIL PURCHASE, TACP WILL EXCHANGE A DEFECTIVE DAV PRODUCT WITH A NEW OR REFURBISHED DAV PRODUCT FOR A FEE.

Rental Units

The warranty for DAV Product rental units begins on the date of the first rental or thirty (30) days after the date of shipment to the rental firm, whichever comes first.

Commercial Units

DAV Products sold and used for commercial purposes have a limited warranty for all parts and labor, which warranty begins on the date of original retail purchase and ends on the date that is ninety (90) days thereafter.

Owner's Manual and Product Registration Card

Read this owner's manual thoroughly before operating this DAV Product.

Complete and mail the enclosed product registration card or register your DAV Product on-line at www.tacp.toshiba.com/service as soon as possible. By registering your DAV Product you will enable TACP to bring you new products specifically designed to meet your needs and help us to contact you in the unlikely event a safety notification is required under the U.S. Consumer Product Safety Act. Failure to complete and return the product registration card does not diminish your warranty rights.

Your Responsibility

THE ABOVE WARRANTIES ARE SUBJECT TO THE FOLLOWING CONDITIONS:

- (1) You must retain your bill of sale or provide other proof of purchase.
- (2) All warranty servicing of this DAV Product must be made pursuant to the TACP DAV Product Warranty Exchange Program.
- (3) The warranties from TACP are effective only if the DAV Product is purchased and operated in the Continental U.S.A. or Puerto Rico.
- (4) Labor service charges for set installation, setup, adjustment of customer controls, and installation or repair of antenna systems are not covered by this warranty. Reception problems caused by inadequate antenna systems are your responsibility.
- (5) Warranties extend only to defects in materials or workmanship as limited above, and do not extend to any DAV Product or parts that have been lost or discarded by you or to damage to the DAV Product or parts caused by fires, misuse, accident, Acts of God (such as lightning or fluctuations in electric power), improper installation, improper maintenance, or use in violation of instructions furnished by TACP; use or malfunction through simultaneous use of this DAV Product and connected equipment; or to units that have been modified or had the serial number removed, altered, defaced, or rendered illegible.

How to Obtain Warranty Services

If, after following all of the operating instructions in this manual and checking the section "Troubleshooting," you find that service is needed:

- (1) For instructions on how to obtain warranty service for your DAV Product under the TACP DAV Product Warranty Exchange Program, contact TACP's Consumer Solutions Center toll free at 1-800-631-3811.
- (2) You must include the original bill of sale (or a copy of the original bill of sale) or other proof of purchase along with the entire DAV Product when sending the DAV Product to the TACP Warranty Exchange Center specified by TACP's Consumer Solutions Center. You are responsible for all inbound transportation and insurance charges for the DAV Product to the TACP Warranty Exchange Center.

For additional information, visit TACP's website:
www.tacp.toshiba.com

ALL WARRANTIES IMPLIED BY THE LAW OF ANY STATE OF THE U.S.A., INCLUDING THE IMPLIED WARRANTIES OF MERCHANTABILITY AND FITNESS FOR A PARTICULAR PURPOSE, ARE EXPRESSLY LIMITED TO THE DURATION OF THE LIMITED WARRANTIES SET FORTH ABOVE. WITH THE EXCEPTION OF ANY WARRANTIES IMPLIED BY THE LAW OF ANY STATE OF THE U.S.A. AS HEREBY LIMITED, THE FOREGOING WARRANTY IS EXCLUSIVE AND IN LIEU OF ALL OTHER WARRANTIES, GUARANTEES, AGREEMENTS, AND SIMILAR OBLIGATIONS OF TACP WITH RESPECT TO THE REPAIR OR REPLACEMENT OF ANY PARTS. IN NO EVENT SHALL TACP BE LIABLE FOR CONSEQUENTIAL OR INCIDENTAL DAMAGES (INCLUDING, BUT NOT LIMITED TO, LOST PROFITS, BUSINESS INTERRUPTION, OR MODIFICATION OR ERASURE OF RECORDED DATA CAUSED BY USE, MISUSE OR INABILITY TO USE THIS DAV PRODUCT).

No person, agent, distributor, dealer, or company is authorized to change, modify, or extend the terms of these warranties in any manner whatsoever. The time within which an action must be commenced to enforce any obligation of TACP arising under the warranty or under any statute or law of the United States or any state thereof is hereby limited to ninety (90) days from the date you discover, or should have discovered, the defect. This limitation does not apply to implied warranties arising under state law.

THIS WARRANTY GIVES YOU SPECIFIC LEGAL RIGHTS AND YOU MAY ALSO HAVE OTHER RIGHTS WHICH MAY VARY FROM STATE TO STATE IN THE U.S.A. SOME STATES OF THE U.S.A. DO NOT ALLOW LIMITATIONS ON HOW LONG AN IMPLIED WARRANTY LASTS, WHEN AN ACTION MAY BE BROUGHT, OR THE EXCLUSION OR LIMITATION OF INCIDENTAL OR CONSEQUENTIAL DAMAGES, SO THE ABOVE PROVISIONS MAY NOT APPLY TO YOU UNDER SUCH CIRCUMSTANCES.

TOSHIBA

ColorStream and ColorStream Pro
are registered trademarks of Toshiba
America Consumer Products, L.L.C.