

TOSHIBA

OWNER'S MANUAL

VHS

Video Cassette Recorder

M-222



INTRODUCTION 2

INSTALLATION AND
PREPARATION 9



BASIC OPERATIONS 25

CONVENIENT
FUNCTIONS 28

SPECIALIZED
OPERATIONS 32

OTHERS 41

Welcome to the high quality picture world created by the TOSHIBA M-222. Read this manual carefully before any use, and enjoy the various convenient functions of this VCR.

	CAUTION RISK OF ELECTRIC SHOCK DO NOT OPEN	
CAUTION: TO REDUCE THE RISK OF ELECTRIC SHOCK. DO NOT REMOVE COVER (OR BACK) - NO USER-SERVICEABLE PARTS INSIDE. REFER SERVICING TO QUALIFIED SERVICE PERSONNEL.		



The lightning flash with arrowhead symbol, within an equilateral triangle, is intended to alert the user to the presence of unisolated "dangerous voltage" within the product's enclosure that may be of sufficient magnitude to constitute a risk of electric shock to persons.



The exclamation point within a equilateral triangle is intended to alert the user to the presence of important operating and maintenance (servicing) instructions in the literature accompanying the appliance.

WARNING: TO REDUCE THE RISK OF FIRE OF ELECTRIC SHOCK, DO NOT EXPOSE THIS APPLIANCE TO RAIN OR MOISTURE. DANGEROUS HIGH VOLTAGES ARE PRESENT INSIDE THE ENCLOSURE. DO NOT OPEN THE CABINET, REFER SERVICING TO QUALIFIED PERSONNEL ONLY.

USER-INSTALLER CAUTION: YOUR AUTHORITY TO OPERATE THIS FCC CERTIFIED EQUIPMENT COULD BE VOIDED IF YOU MAKE CHANGES OR MODIFICATIONS NOT EXPRESSLY APPROVED BY THIS PARTY RESPONSIBLE FOR COMPLIANCE TO PART 15 OF THE FCC RULES.

Note to CATV system installer:

This reminder is provided to call the CATV system installer's attention to Article 820-40 of the NEC that provides guidelines for proper grounding and, in particular, specifies that the cable ground shall be connected to the grounding system of the building, as close to the point of cable entry as practical.

Copyright

It is permissible to record television programs, film video tapes and other material only in the event that third party copyrights and other rights are not violated.

Accessories

- Antenna Cable
- Remote Control Unit (Wireless) with two AAA batteries
- Safety Instructions

In the spaces provided below, record the Model and Serial No. located at the rear of your video cassette recorder.

Model No. _____ Serial No. _____

Retain this information for future reference.

INTRODUCTION

This section contains general information related to VCR care and maintenance, instructions on how to use this manual and an outline of the VCR's special feature.

Important Precautions

Save Original Packing materials

The original shipping carton and packing materials will come in handy if you ever have to ship you VCR. For maximum protection repack the set as it was originally packed at the factory.

Moisture Condensation

Never operate this unit immediately after moving it from a cold location to a warm location. When the VCR is exposed to such a change in temperature, moisture may condense on the cylinder inside the machine, one of its most crucial internal parts. This unit is equipped with an automatic moisture condensation prevention circuit designed to cope with this problem. It takes about TWO HOURS for the circuit to work with the power cord plugged in. Please do not use the VCR during this time.

Compatibility

This video cassette recorder (VCR) is compatible with any other VCR bearing the **VHS** mark.  VHS equipment is also compatible with existing, non-HQ VHS equipment.

Table of Contents

INTRODUCTION

INTRODUCTION	2
Important Precautions	2
Table of Contents	2
Features	3
CONTROLS	5
Front Panel	5
Remote Control	6
Using Remote Control	7
Rear Panel	8

INSTALLATION AND PREPARATION

INSTALLATION	9
TV Antenna and VCR Connections	9
VCR and TV Connections	10
CATV Connections	11
Setting the VCR Output Channel	15
Using the TV/VCR Button	15
Setting the LANGUAGE Screen	16
PREPARATION	18
Setting the Clock	18
About the SET UP Screen	19
About the DISPLAY Screen	20
Channel Programming	21
Operating the FS Tuner	22
Using the Video Cassette Tape	24

BASIC OPERATIONS

PLAYBACK	25
Basic Playback	25
Auto Repeat	26
RECORDING	27
Basic Manual Recording	27

CONVENIENT FUNCTIONS

COUNTER FUNCTION	28
Linear Time Counter Function	28
Zero Return Function	28
AUTO SEARCH	29
Index	29
Index Register	29
Index Search	30
Skip Search	31

SPECIALIZED OPERATIONS

SPECIALIZED EFFECTS	32
Picture Search	32
Still Frame	33
TIMER RECORDING	34
One Touch Timer Recording	34
Programmable Timer Recording	37
SPECIALIZED OPERATIONS	40
Copying VCR Recording	40

OTHERS

OTHERS	41
Specifications	41
QUICK REFERENCE	42
Installation	42
Before Calling Service Personnel	44

Features

Other Special-Features:

181 Channel Cable compatible FS (Frequency Synthesized) Tuner

This FS tuner automatically selects with highest accuracy, all receivable channels such as those for UHF, VHF and CATV.

1 Year, 8-Program Programmable Timer

With this handy function you can program your VCR to make up to eight different kinds of unattended recordings in a year period.

Auto-Rewind

All kinds of tapes are rewound automatically when they reach their end during recording or playback.

Quick-Access System

The quick-access feature eliminates the "delay" when you begin recording or playing back a tape. The VCR automatically positions the tape for "action" whenever a cassette is inserted or when the VCR is turned on with a cassette already inserted.

The VCR also keeps the tape "ready" when you place the VCR in the stop mode. After you have placed the VCR in the stop mode, you will hear the cylinder head inside the VCR continue to rotate for about five minutes while the VCR is "waiting" for you to select the next function. After five minutes, the cylinder head will stop rotating and you will no longer hear it.

Operation mode OSP display System

This VCR will show messages on the TV screen in your desired contents. You can operate the following with the On-Screen function:

- VCR mode display
- Language setting
- Clock setting
- Set Up
- Timer Programming

Auto Power On and Fully-Automatic Play

When a cassette is loaded, the power goes on automatically. When a pre-recorded tape (without safety tab) is loaded into the unit, the power goes on, then the VCR's Fully-Automatic Play function guides the tape through play and rewind automatically.

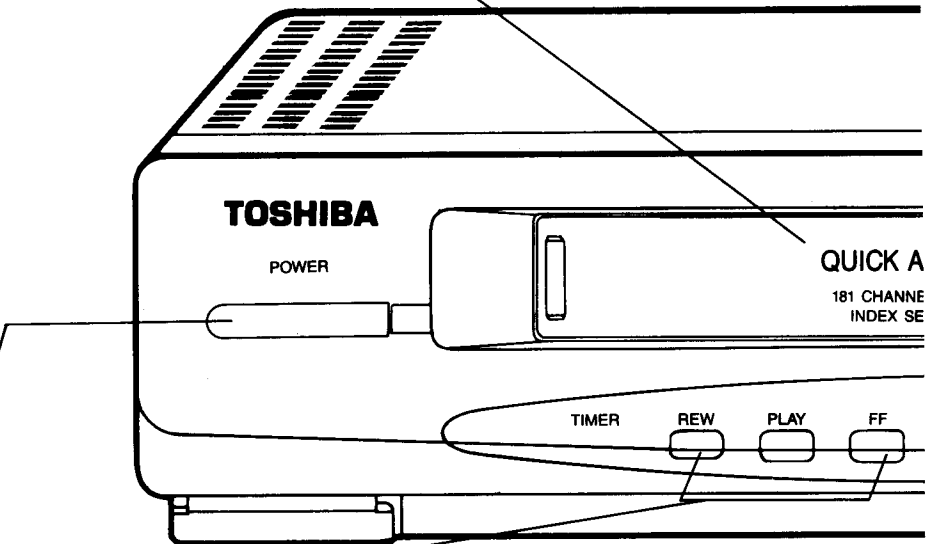

Picture Search

This function lets you speed up playback both in the forward and reverse directions at 5 times (SP speed only) or 9 times (SLP speed only).

Accel Search

If you keep pressing the FF or REW button during playback, the searching speed will be increased to 7 times (SP speed only) or 21 times (SLP speed only) normal speed.

Power

To turn the VCR power on or off, press this button.

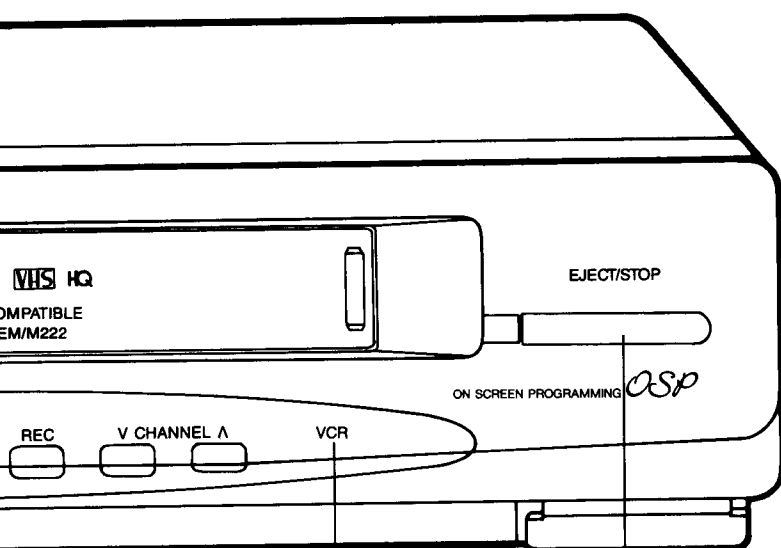

EJECT/STOP

Press this button 2 times to eject a tape from the cassette compartment. Also this button uses to stop.

VCR Indicator

Pressing the TV/VCR button turns the VCR indicator on or off.

- When the VCR indicator is on. The TV receives the picture from the VCR, and you can select channels with the CHANNEL buttons on the VCR.
- When the VCR is turned off (or the VCR indicator is off), your TV receives the picture from your home antenna or cable-TV system as it did before you connected the VCR. You can then use the CHANNEL buttons on your TV to select channels.

CONTROLS

Front Panel

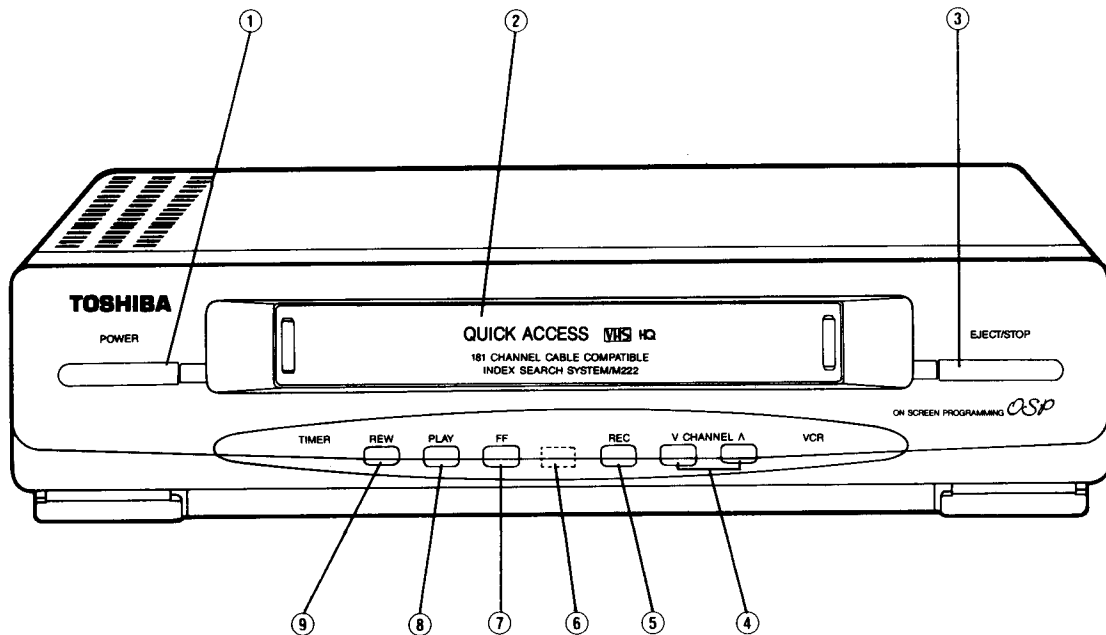

- ① **POWER button**
Press this button to turn the VCR on after it is plugged in. Note that the power goes on automatically (Auto Power ON) when a tape is loaded into the cassette compartment.
- ② **Cassette Compartment**
Note that the power goes on automatically when a cassette is inserted in the compartment. Also, if a prerecorded cassette with the safety tab missing is inserted, the Fully Automatic Play function is activated.
- ③ **EJECT/STOP button**
Press this button 2 times to eject a tape from the cassette compartment. Also this button uses to stop.
- ④ **CHANNEL buttons**
The UP (\wedge) button is used for sequential Selection in the upper direction, and the DOWN (\vee) button is for sequential selection in the lower direction.
- ⑤ **REC button**
Press this button to begin recording a program.
- ⑥ **Infrared Remote Control Receiver**
This receiver picks up infrared light commands from the remote control.
- ⑦ **FF button**
When this button is pressed while the VCR is in a mode such as Stop, Rewind or Forward Picture Search, the tape advances at high speed. When this button is pressed while the VCR is in a mode such as Play, Fast-Forward, Still Reverse Picture Search, the VCR enters the Forward Pictures Search mode.
- ⑧ **PLAY button**
Press this button to begin playing back a tape.
- ⑨ **REW button**
When this button is pressed while the VCR is in a mode such as Stop, Fast-Forward or Reverse Picture Search, the tape is rewound at high speed. When the button is pressed while the VCR is in a mode such as Play, Rewind, Still, or Forward Pictures Search, the VCR enters the Reverse Picture Search mode.

Remote Control

Preparation Operating Part

- ① **POWER button**
To turn the VCR power on or off, press this button.
- ② **CHANNEL buttons**
To select channels directly, press these buttons.
Note:
 - To enter channel 5, press button "0" and then button "5".
 - To enter channel 17, press button "1" and then button "7".
 - To enter channel 125, press button "1", "2" and "5" within 2 seconds interval.
- ③ **CHANNEL (AM/PM) buttons**
The UP (▲) button is used for sequential selection in the upper direction, and the DOWN (▼) button is for sequential selection in the lower direction. When setting times in OSP mode, use these buttons to switch between AM and PM.
- ④ **AUTO CHANNEL PROGRAM buttons.**
(see p. 21)
- ⑤ **TV/VCR button**
To view the TV set, set the button to "TV".
To use the VCR tuner, set the button to "VCR".
- ⑥ **TV/CATV button**
To view CATV, set the button to "CATV".
To view VHF or UHF, set the button to "TV".
- ⑦ **TV/LINE button**
To record from AUDIO and VIDEO IN jacks on the VCR, set the button to "LINE", set the button to TV for normal recording.

Playback and Recording Operating Part

- ⑧ **FF button**
To forward the tape at high speed or to forward the picture to search for a section, press this button.
- ⑨ **TRACKING/V-LOCK**
When you play a tape recorder on a different VCR horizontal streaks (noise bars) may appear in the picture. Press this button to remove noise bars.
In still mode adjust this control to minimize vertical shaking on the TV screen.
- ⑩ **COUNTER RESET button**
Press this button to return the counter to 0H 00M 00s on the screen.
- ⑪ **ZERO RETURN button (see p. 28)**
Press this button and the tape fast forwards or rewinds and stops automatically at the counter at approximately 0H (hour) 00M (minute) 00s (second).

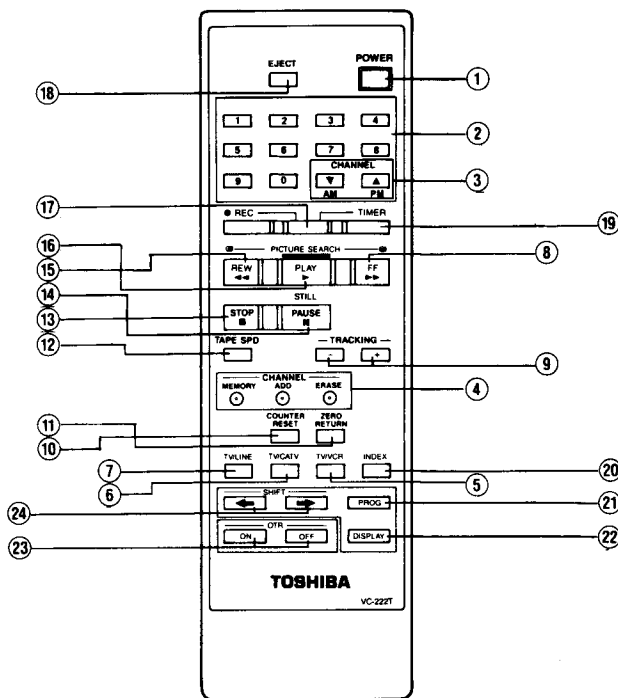

- ⑫ **TAPE SPEED**
Press to select desired TAPE speed: SP (standard play) or SLP (super long play). The tape is automatically played back at the speed it was recorded.
- ⑬ **STOP button**
To stop the VCR in any mode, press this button.
- ⑭ **PAUSE/STILL button**
To eliminate unnecessary pictures when recording, press this button. Also, to still a picture in playback, press this button.
- ⑮ **REW button**
To rewind the tape at high speed or to reverse the picture to search for a section, press this button.
- ⑯ **PLAY button**
To activate the Playback mode as well as special effects in playback operation, press this button.
- ⑰ **REC buttons**
To start recording on a tape that has been loaded, press these buttons together.
- ⑱ **EJECT button**
Press the button to eject a tape from the cassette compartment.

OSP Operating Part

- ⑲ **TIMER buttons**
These buttons are used as the end procedure for setting timer programming. Then the timer waits to record the programs as set.
- ⑳ **INDEX button (see p. 30)**
To activate the index Search or Skip Search, press this button.
- ㉑ **PROGRAM button**
Used to select OSP mode and normal TV programs each time the button is pressed.
- ㉒ **DISPLAY button**
Press once to show on screen: Status of tape (Function, Channel, Tape counter, date, day and time, tape speed). Press twice to show tape counter only.
- ㉓ **OTR ON/OFF Buttons**
This convenient function enables you to program the VCR quickly to begin unattended recording of TV programs starting either immediately or within twenty-four hours. It is especially designed for the people "on the go".
- ㉔ **SHIFT buttons**
These keys are used to move the cursor to the item you wish to set, such as program number, channel, day, tape speed, and recording start/end time.

Using Remote Control

Battery Installation

How to install batteries into the Remote Control Unit.

- ① Remove the battery cover on the reverse side of the unit.
- ② Install 2 batteries ("AAA" size) into the unit. Carefully install batteries to match the polarity diagrams.
- ③ Close the battery cover.

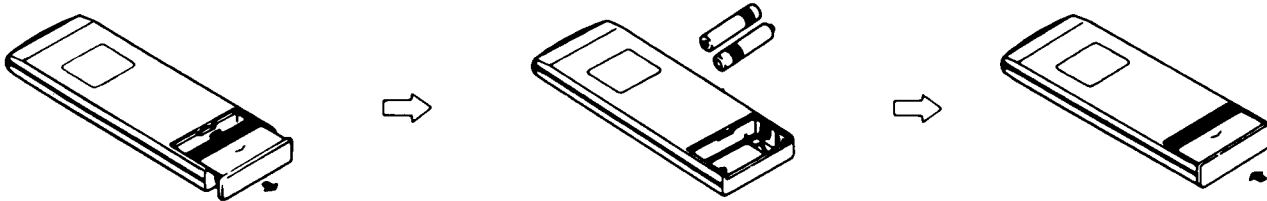

Notes:

- Battery life is about 1 year. (It varies according to how the batteries are consumed.)
- Replace both batteries when an operation is not stable or disabled.
- Remove the batteries when the remote control is left unused for a long time.
- Do not throw used batteries into fire.

Remote Control Operation Range

1. When using the remote control, any object between it and VCR will block the path of the beam. Dark walls, direct sunshine or very bright (incandescent) light will reduce the sensitivity of the remote control.
2. Hold the remote control within an angle range of about 30° from either side of the VCR receptor center as shown.
3. When the remote control is pointed straight at the VCR receptor, it will work within about 23 feet (7m) from the VCR.
4. Point the front of the remote control directly at the front of the VCR.

When the remote control is pointed upward or downward at the receptor within a range of 30° of the receptor, it will work within about 17 feet (5m) from the VCR.

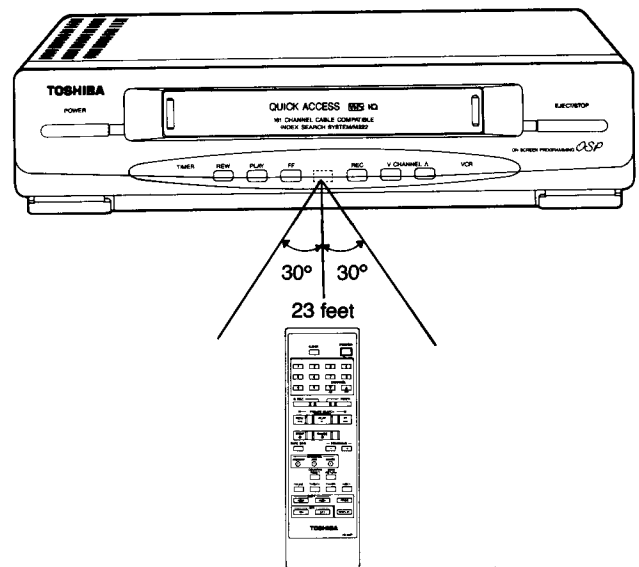

Notes:

- For a correct operation press buttons on the remote control at intervals of at least 1 second.
- Keep the unit away from heat and humidity and sources of electrical shock. Also, remove batteries from the remote control when it is not to be used for a long period of time to safeguard leaking battery acid.
- Be careful not to drop or shock the remote control.
- Be careful not to spill water on the remote control or place it on anything wet.
- Do not take the remote control apart.

Rear Panel

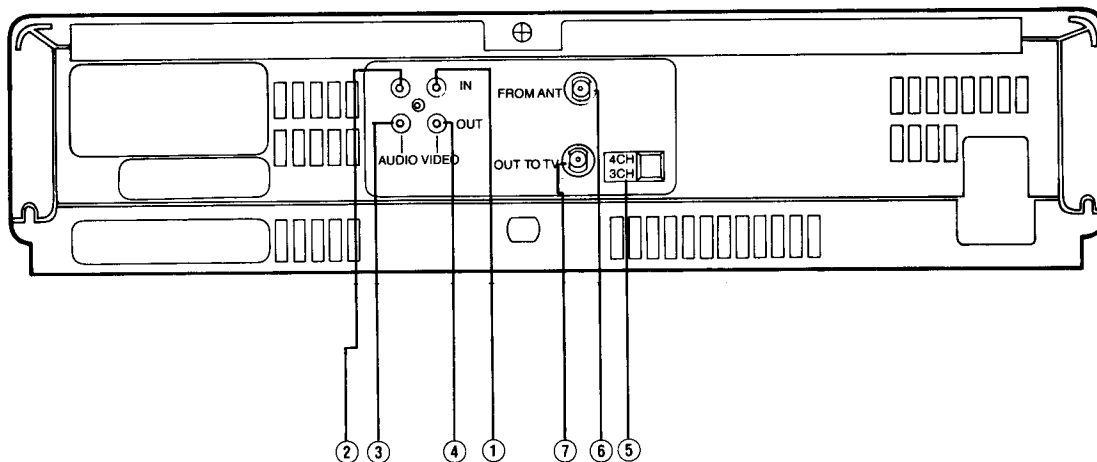

① VIDEO IN jack

To record from an external video source, such as a VCR, VCR or TV set, connect this jack to the VIDEO output jack of one of those sources.

② AUDIO IN jack

To record from an external audio source connect this jack to the AUDIO output jack of an external audio source, such as a VCR, VCR, audio receiver or TV set.

③ AUDIO OUT jack

For external recording or monitoring connect this jack to the AUDIO input on an external audio equipment.

④ VIDEO OUT jack

For external recording or monitoring, connect this jack to the VIDEO input of a VCR or TV set.

⑤ 3-4 output channel selector switch

In order that signals received by the VCR can be converted into signals suitable for your TV set, move this switch to either 3CH or 4CH, whichever channel is unused in your area.

⑥ VHF/UHF ANTENNA IN TERMINAL

For VHF reception, UHF reception or cable TV reception, connect this terminal to a VHF antenna, a UHF antenna or cable TV terminal.

⑦ VHF/UHF ANTENNA OUT TERMINAL

Connect this terminal to the TV set's VHF IN terminal or VHF/UHF IN terminal.

INSTALLATION

TV Antenna and VCR Connections

To connect the VCR to a antenna (Fig. 1), to combination VHF/UHF antenna (Fig. 2), take the following steps:

Remove the VHF and/or UHF cables from you TV terminals and reconnect them to the VCR terminal as shown in the diagrams below.

Note: For VHF and UHF connections, follow procedure ① if you have a 75Ω (ohm) coaxial cable, and follow procedure ② if you have a 300Ω (ohm) twin lead connector.

Fig. 1 VHF or UHF Reception Areas

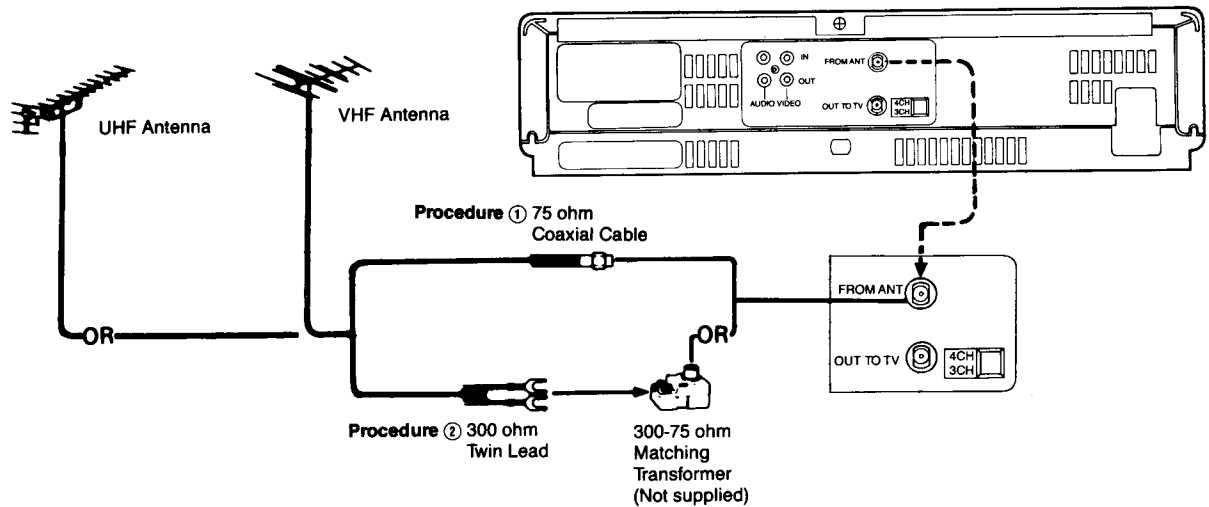
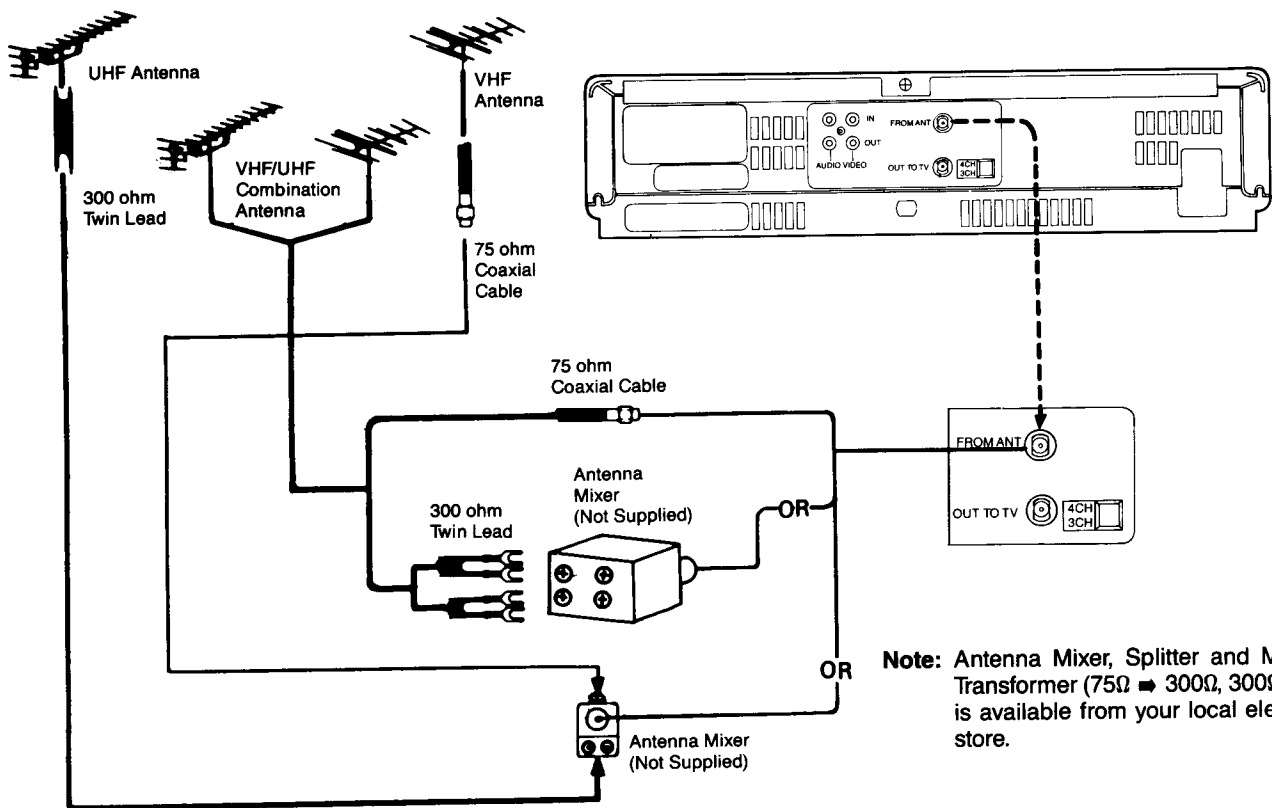

Fig. 2 Combined VHF/UHF Reception Areas



INSTALLATION AND PREPARATION

VCR and TV Connections

Fig. 1 VHF (75ohm/300ohm) or VHF (75ohm) terminals connection

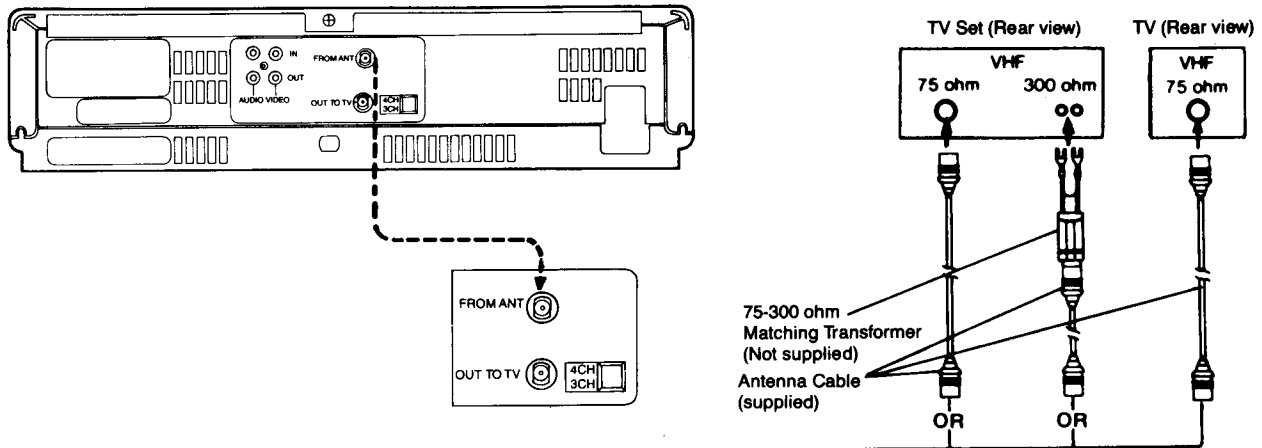
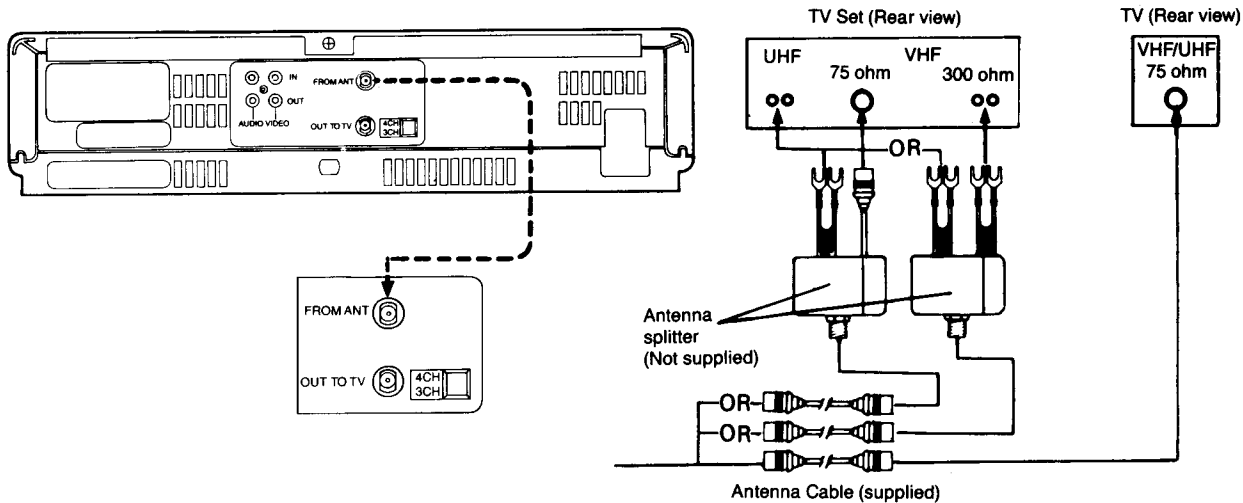
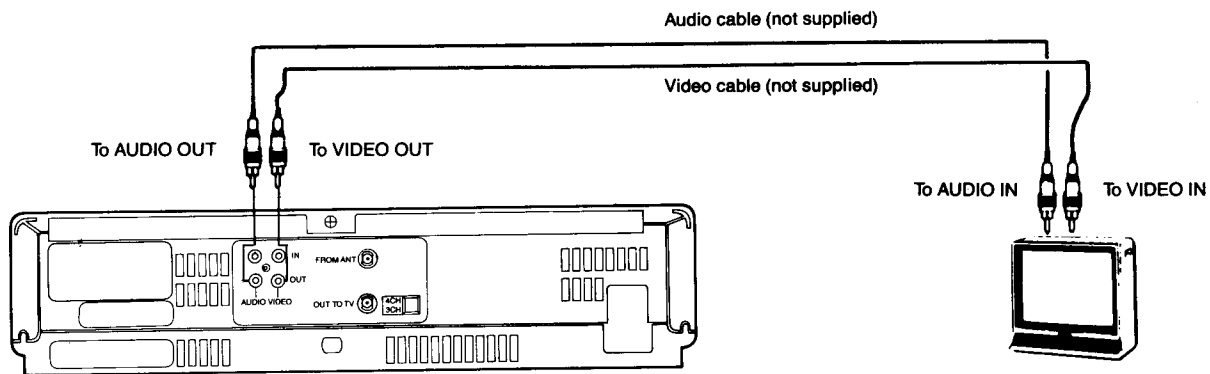

Fig. 2 VHF/UHF (75ohm/300ohm) or VHF/UHF (75ohm) terminals connection



Connection to the TV with "VIDEO IN" and "AUDIO IN" Connections



CATV Connections

There are several different systems of cable television at present. Therefore, there may be times when you use this VCR with one of these cable TV services. We recommend that you consult your cable TV company to make sure that the cable is connected properly to match the cable TV system you want to watch.

To record and watch unscrambled channels

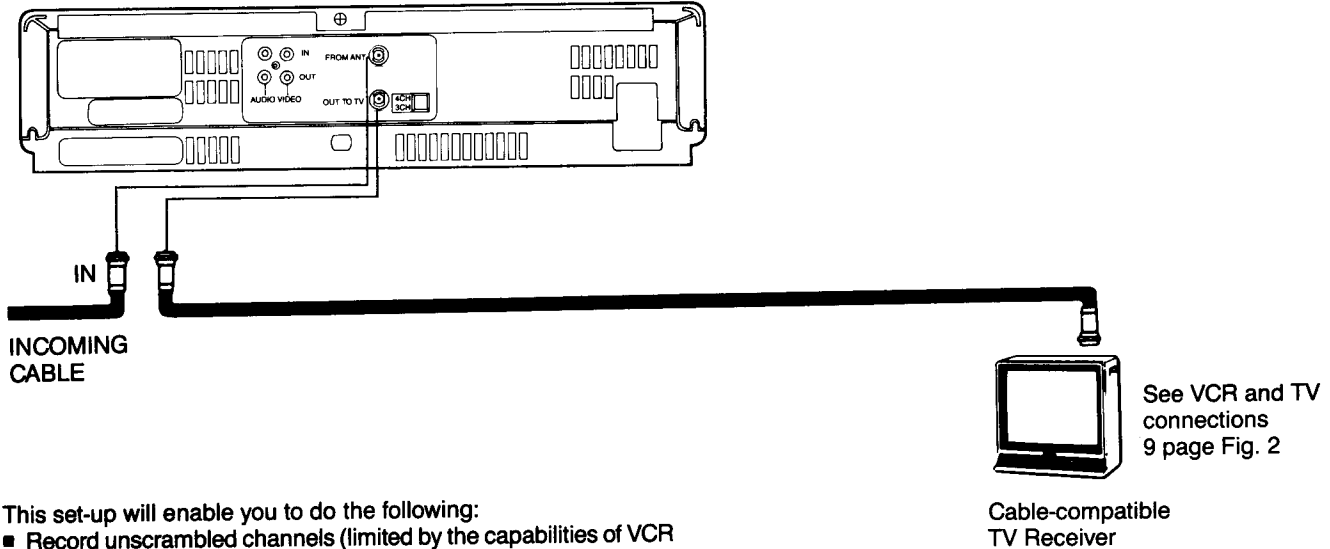

- This set-up will enable you to do the following:
- Record unscrambled channels (limited by the capabilities of VCR tuner, for example 122 channel tuning or 181 channel tuning.)
 - Record one channel and watch another.
 - Use the programmable timer.

To record an unscrambled channel and watch another channel (scrambled or unscrambled)

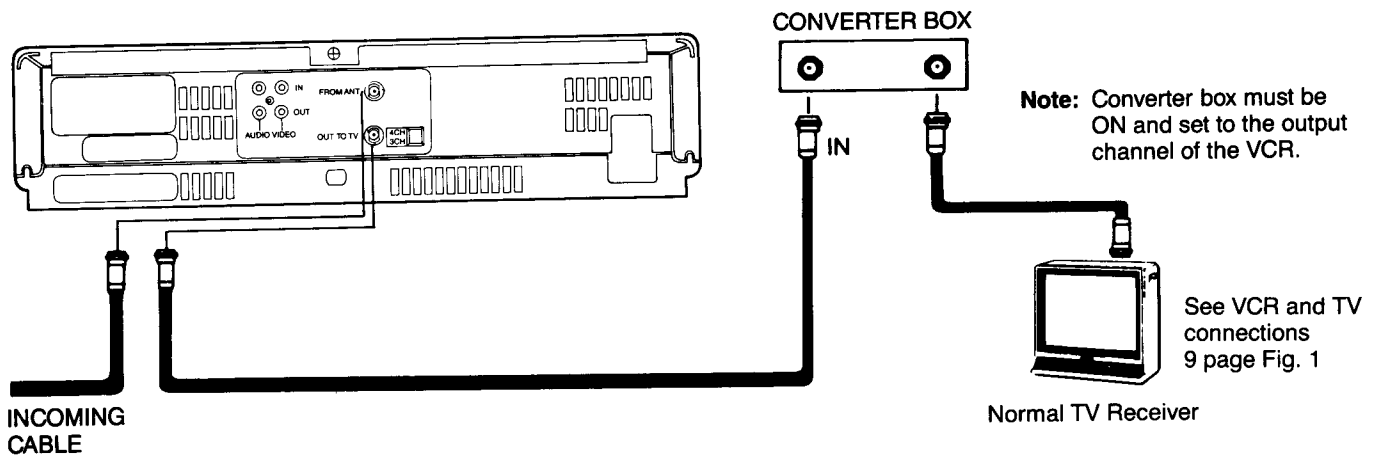

- This set-up will enable you to do the following:
- Record unscrambled channels (limited by the capabilities of VCR tuner, for example 122 channel tuning or 181 channel tuning.)
 - Record one channel and watch another.
 - Use the programmable timer to record a cable signal.

- Notes:**
- This set-up will not allow you to record scrambled channels.
 - When in playback or when using the VCR tuner (TV/VCR switch in VCR position), the converter box must be set to channel 3 or 4.
 - When TV/VCR switch is set to the TV position, the converter box can tune into any available channel.

To record and watch the same channel (unscrambled/scrambled)

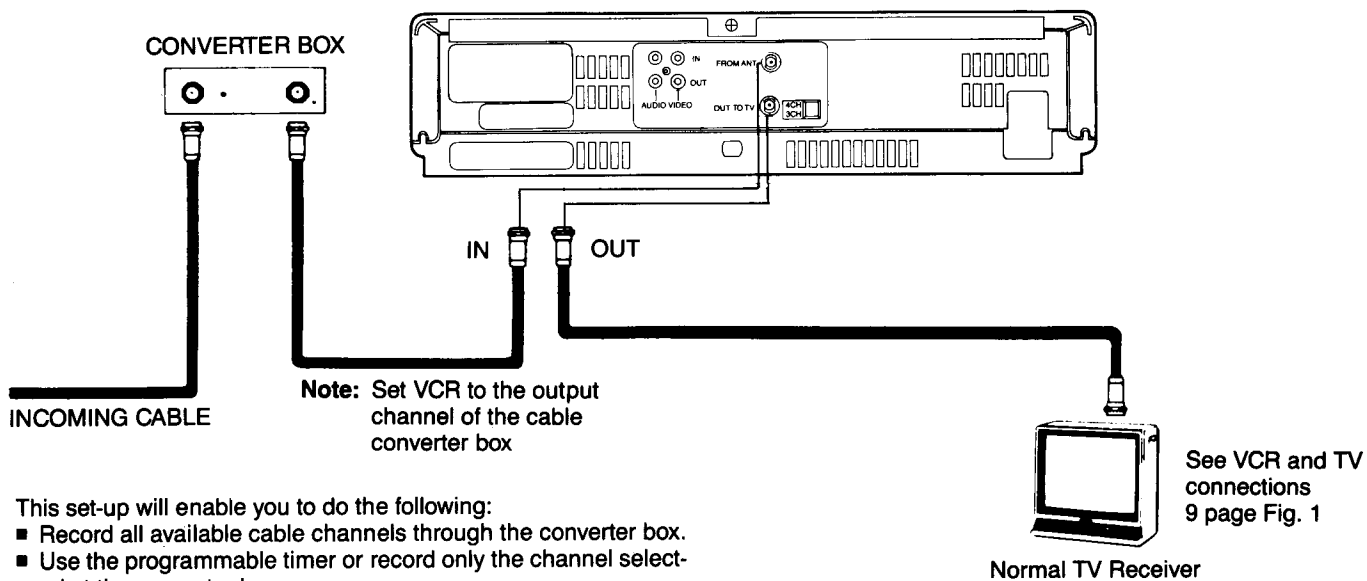

To record an unscrambled channel and watch only unscrambled or scrambled channels

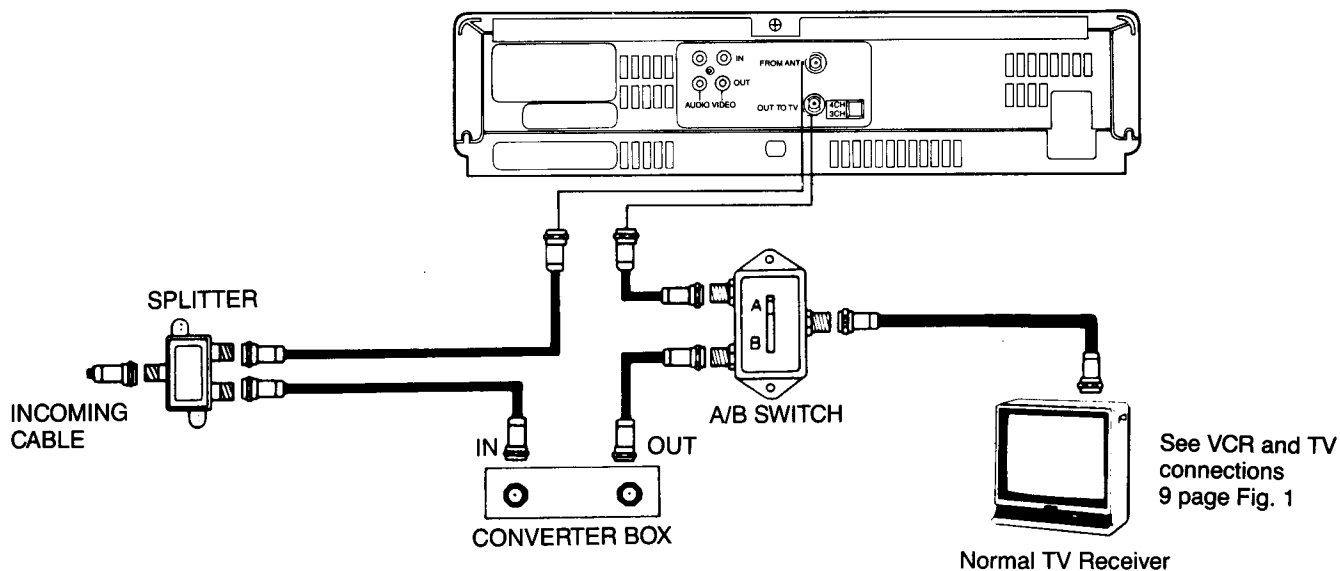

**To record and watch the same channel (scrambled or unscrambled)
To record one unscrambled channel and watch another unscrambled channel**

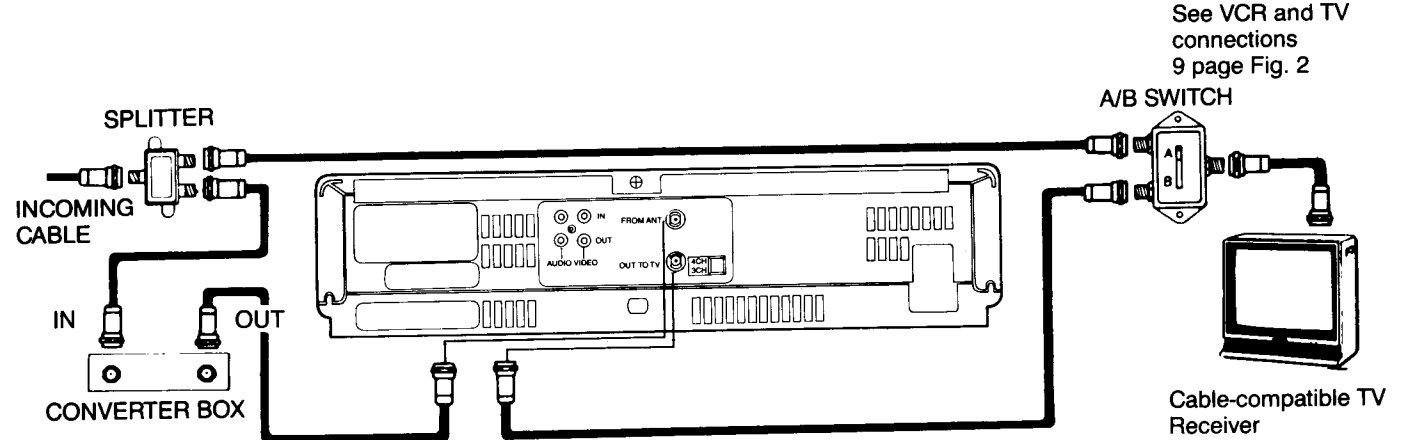

- Notes:**
- Set the VCR channel selector to output channel of the converter.
 - Select the channel to be recorded on the converter.

- Notes:**
- Set the TV channel selector to output channel of VCR (3 or 4).

- This set-up will enable you to do the following:
- Record all cable channels from the converter box.
 - Record ones scrambled channel and watch another unscrambled channel.

- Use the TV remote control when the A/B switch is in the "A" position.
- Use the programmable timer to record only the channel selected on the converter box. (Converter box power must be ON.)

To record and watch a scrambled or unscrambled channel

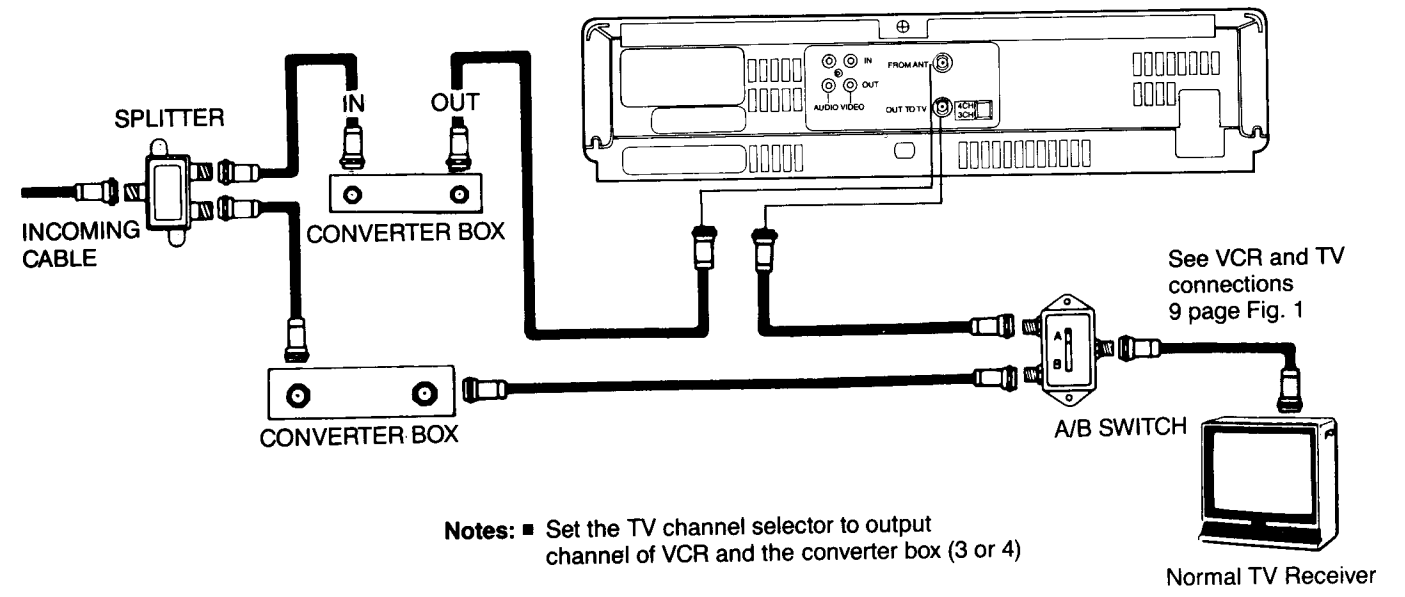

- Notes:**
- Set the TV channel selector to output channel of VCR and the converter box (3 or 4)

- This set-up will enable you to do the following:
- Record any cable channel.
 - Record one channel and watch another.
 - Use programmable timer to record only the channel selected at the converter box.

To record and watch the same channel (scrambled/unscrambled)
To record one unscrambled channel and watch another unscrambled channel

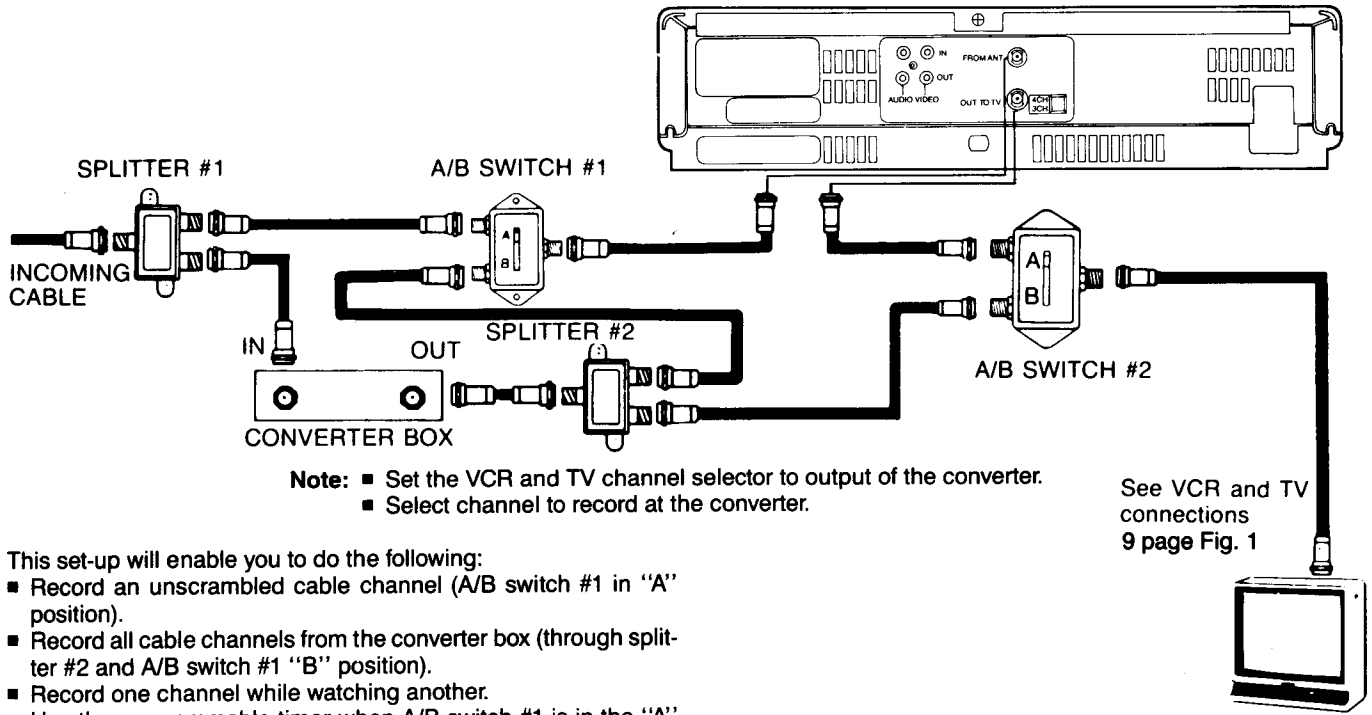

Note: ■ Set the VCR and TV channel selector to output of the converter.
 ■ Select channel to record at the converter.

See VCR and TV connections
 9 page Fig. 1



- This set-up will enable you to do the following:
- Record an unscrambled cable channel (A/B switch #1 in "A" position).
 - Record all cable channels from the converter box (through splitter #2 and A/B switch #1 "B" position).
 - Record one channel while watching another.
 - Use the programmable timer when A/B switch #1 is in the "A" position.

"Unscrambled" Cable Channels

Cable companies usually include "Unscrambled" channels in their basic subscription price. Depending on the tuning capability of your TV (how many cable channels your TV is capable of tuning to) you may not need a cable converter box (supplied by the cable company) to view "unscrambled" cable channels on your TV set.

"Scrambled" Channels

Extra (optional) pay cable channels, like HBO and Cinemax in some localities, are often "scrambled" by the cable company. To view these channels on your TV, you must use the cable converter (decoder) box supplied by the cable company.

Cable Converter Box (supplied by Cable Company)

Until recently, all television and VCR receivers were equipped with 69 channel tuners capable of tuning the 12 standard VHF channels (2-13) and the 56 UHF channels (14-69). Since cable television systems do not use the UHF band, once they began expanding beyond 12 channel capacity (some cable companies transmit up to 100 channels) some form of converter became necessary to enable their subscribers to tune in the additional channels. This "cable converter box" rebroadcasts the programs to your TV set or VCR on one designated channel, usually channel 2, 3, or 4. When you use a converter box, you will normally change channels using the channel selector on the box. Some cable converters have built-in decoders that translate "scrambled" pay TV channels (i.e. HBO) so they can be used by your TV set.

Cable Compatible—either TV or VCR when cable is connected can tune to nonscrambled cable channels, without the use of a cable converter box. There is a limitation to the tuning mechanism of the TV or VCR. This is usually as 105 channel tuning, 117 channel tuning, 133 channel tuning.

Frequency Conversion—simply means the ability to change one frequency to another (ex. channel 7 is selected – the converter box takes the channel 7 information and outputs the channel 7 information on channel 3 frequency; for example when channel 11 is selected – the converter box takes the channel 11 information and outputs the channel 11 information on channel 3 frequency.) The converter box and the VCR use this principle of frequency conversion.

Setting the VCR Output Channel

Set the output channel selector on the rear panel to the unused channel in your area, 3CH or 4CH. Insert a screwdriver into the slot at the rear of the VCR and slide the output channel selector to 3CH or 4CH.

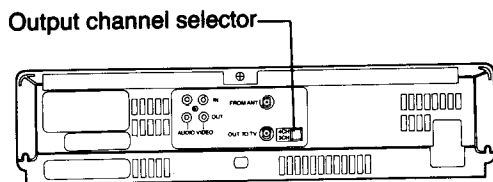

Notes

- When you have a cable TV, select the channel which gives you the best reception.
- To play back a tape, set the TV to the same channel as the VCR output channel selector (3 or 4).

Using the TV/VCR Button

Use this button to select the TV mode or VCR mode.

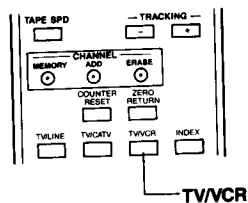

VCR Mode (using the VCR tuner)

1. Turn on the TV and select the VCR output channel, 3CH or 4CH.
2. Turn on the VCR.
3. Set the VCR to the VCR mode with the *TV/VCR* button.
4. Select the desired channel with the *CHANNEL* ∇/\blacktriangle buttons on the VCR or the channel buttons on the remote control unit. The program of the selected channel will appear on the TV screen.

TV Mode (using the TV tuner)

1. If the VCR power is off, turn on the TV. There is no need to turn on the VCR.
2. Select the desired channel using the channel select buttons on the TV.

Note

If the VCR is on and the "VCR" indicator lights on the LED. Press the *TV/VCR* button so that the indicator goes off.

Setting the LANGUAGE Screen

This VCR will show messages on the TV screen in your desired language, English or Spanish. You can operate the following with the On-Screen function:

- Clock setting
- Setup
- Timer programming
- Confirming timer programmed data
- VCR operation

Basic operation

Your desired language setting will be required in the following cases:

- When you use the VCR for the first time.
- When the AC power cord is reconnected since a long period of time has passed.
- After a power failure

Use the remote control unit.

1. Turn on the VCR.
2. Press the PROG button.
The LANGUAGE screen will appear on the TV screen.

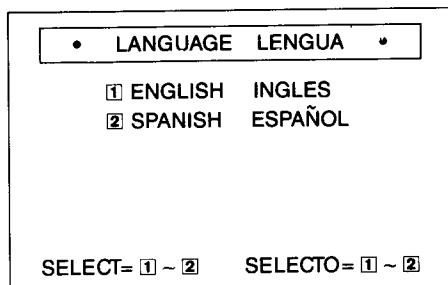

3. Press button 1 to select your English language.
The MENU screen will appear on the TV screen in English.

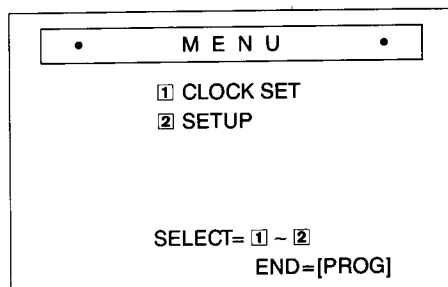

Now the ENGLISH setting is complete.

4. Press the PROG button to return to the normal screen.

Notes:

- After the language setting is complete, the LANGUAGE screen will not appear on the TV screen. However, you can select the desired language with the SETUP screen.
- The operating instructions except on this page will be given in English. For reference, Spanish screen arts will also be put together with English ones.

SETTING THE LANGUAGE SCREEN (ESPAÑOL)

SELECCIÓN DEL IDIOMA DE LA PANTALLA

Esta videgrabadora muestra los mensajes en la pantalla del televisor en inglés o español, el idioma que desee. Usted podrá emplear las funciones de pantalla siguientes:

- Puesta en hora del reloj
- Configuración
- Programación del temporizador
- Confirmación de los datos programados del temporizador
- Operación de la videgrabadora

Operación básica

Usted tendrá que determinar el lenguaje de la pantalla en los casos siguientes:

- cuando emplee la videgrabadora por primera vez
- cuando conecte el cable de alimentación después de haberlo dejado desconectado durante mucho tiempo.
- después de un corte del suministro eléctrico

Empleo de la unidad de control remoto

1. Conecte la alimentación de la videgrabadora.
2. Presione la tecla PROG.
En el televisor aparecerá la pantalla LANGUAGE.

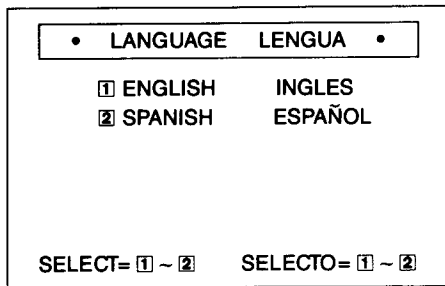

3. Presione la tecla 2 para seleccionar el idioma español.
En la pantalla del televisor aparecerá la pantalla MENU en inglés.

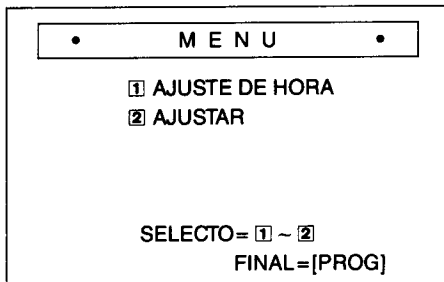

De esta forma habrá finalizado la configuración del lenguaje de la pantalla.

4. Presione la tecla PROG para volver a la pantalla normal.

Notas:

- Después de haber determinado el idioma, en el televisor no aparecerá la pantalla LANGUAGE. Sin embargo, usted podrá seleccionar el idioma deseado con la pantalla SETUP.
- El manual de instrucciones, excepto esta página, se ofrecerá en inglés. A modo de referencia, las indicaciones de la pantalla de español aparecerán junto con las de inglés.

PREPARATION

Setting the Clock

When the power cord is plugged into the receptacle on the wall or after power failure, if press DISPLAY button on the remote control sequentially, TV screen displays everyday 1/1/91 TUE 12:00 AM blinking. (Example; To set the current time to Sunday 6/30/91 10:59 AM)

1. Turn on the VCR.
2. Press the PROGRAM button. LANGUAGE screen will appear on the TV screen.
 - If you press the "1" button on the remote control, ENGLISH MENU screen appears.
 - As same method, press the "2" button, SPANISH MENU screen appears.

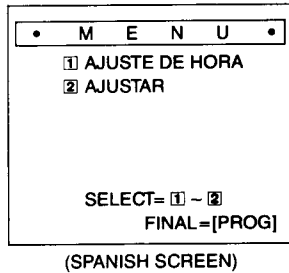
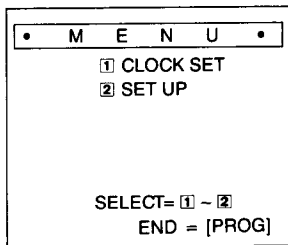

3. Press "1" button of the CHANNEL buttons on the remote control.

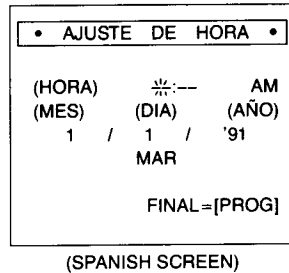
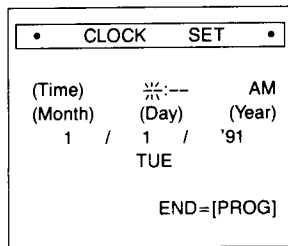

4. To enter the present time, press the CHANNEL buttons on the remote control one at a time.
 For example, to enter 10:59, press the button 1, 0, 5, and then 9.

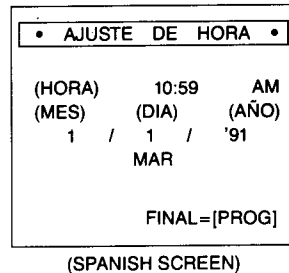
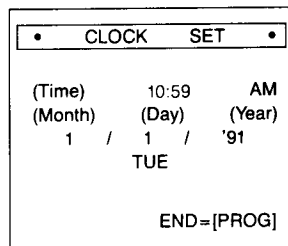

5. To select AM or PM
 - To enter AM, press the CHANNEL DOWN button.
 - To enter PM, press the CHANNEL UP button.

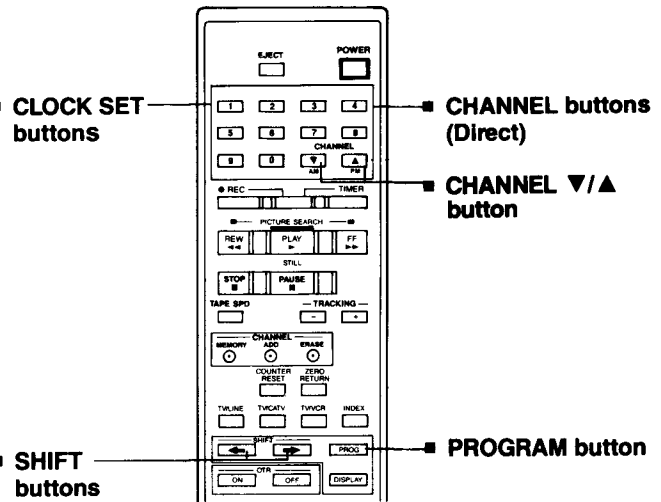

6. To set the month, day and year, press the CHANNEL buttons one at a time. Press the button 0, 6, 3, 0, 9 and then 1.

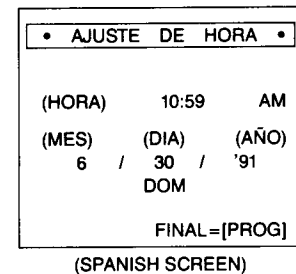
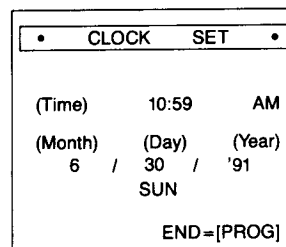

The day (SUN) will be automatically set immediately.

7. Press the PROGRAM button.
 Now the clock starts.
 The TV screen return to the MENU screen after setting the clock.

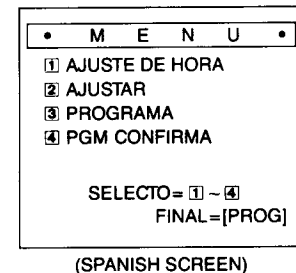
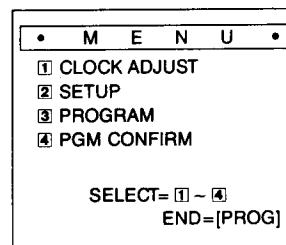

To return to the normal TV screen, press the PROG button.

Notes:

- The buttons for setting the clock are on the remote control.
- If you press a wrong digit, press the SHIFT buttons repeatedly until the incorrect digit flashes, and then enter the correct digit.
- When the VCR's back-up time is exceeded during a power failure 12:00 AM on the screen will blink.
When this happens reset the clock to the correct present time according to the above steps.

About the SET UP Screen

The SET UP screen is used for setting, EDIT, AUTO REPEAT and ENGLISH/ESPAÑOL
To display the SET UP screen, perform the following steps.

1. Press the *PROG.* button on the remote control unit to display the MENU screen.
2. Press the 2 button on the remote control unit to display the SET UP screen.
3. Set the following items respectively.
 - ① EDIT : see page 40
 - ② AUTO REPEAT : see page 26
 - ③ ENGLISH/ESPAÑOL : see page 16
4. Press the *PROG.* button twice after setting to return to the normal screen.

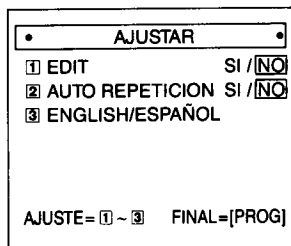
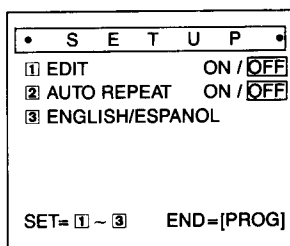

(SPANISH SCREEN)

About the DISPLAY Screen

There are 3 kinds of DISPLAY screen in this VCR. Screen are as follows.

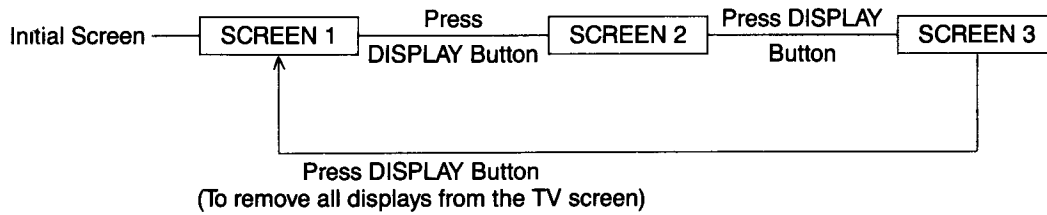

SCREEN 1

- Press the PLAY button.
- When you change MODE, SPEED, CHANNEL (TV/LINE), their informations are displayed 5 seconds on the TV screen.

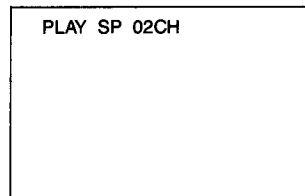

SCREEN 2

- Press the DISPLAY button once to display MODE, SPEED, CHANNEL, COUNTER, DAY, TIME on the TV screen.

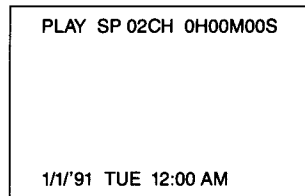

SCREEN 3

- Press the DISPLAY button again to display only the COUNTER on the TV screen.

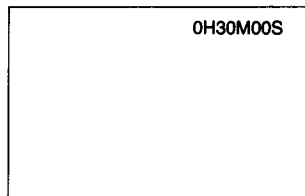

CHANNEL PROGRAMMING

Programming Active Channels into VCR's Tuner

The CHANNEL buttons (MEMORY, ADD, ERASE) on the remote control make it easy and convenient to program TV stations into the VCR's scan list.

Only the channels which are registered to scan list, if push the CHANNEL ▲ or ▼ button, they are displayed on the TV screen. Your VCR tuner selects present broadcasting channel automatically which one of the registered channel to scan list when you press the CHANNEL ▲ or ▼ button.

When the scan list is empty, the VCR stops changing the channel even though you press the CHANNEL ▲ or ▼ button.

Note: All of the channels are registered in the scan list before automatic programming.

Automatic programming is usually a "one-time" procedure, but you will need to repeat if you move to the other area, or if power is interrupted for an extended period.

To program active channels:

- 1 Connect the VCR to antenna.
- 2 Turn on VCR by pressing the POWER button.
- 3 Press and release the MEMORY button.
 - Channel numbers change from 1 to 125 in the "CATV mode" and return to the channel you selected before Automatic Programming.
- 4 If you want to delete or add individual channels from the scan list, refer to the instructions at the below.

Deleting Channels from the Scan List

You may want to have only a few favorite channels in the scan list so you can select them more quickly with the CHANNEL ▲ and ▼ buttons. (Use the numbered buttons on the remote control to select channels you deleted from the scan list). Occasionally Automatic Programming may include a vacant channel in the scan list if there happened to be some sort of "noise" or "stray signal" on the channel when the tuner was programmed. This procedure explains how to delete any unwanted channels from the scan list.

- 1 Use the CHANNEL ▲ or ▼ button to select the channel that you want to remove from the scan list.
- 2 Press the ERASE button.
- 3 Repeat the procedure for each channel you want to delete from the scan list.

Adding Channels to the Scan List

You may have deleted a channel from the scan list and want to put it back. Occasionally Automatic Programming may "miss" an active channel because the signal is very weak or because the channel happened to be "off the air" when the tuner was programmed. Use this procedure to put any channel in the scan list.

- 1 Use the digit (0-9) buttons on the remote control to select the channel you want to add to the scan list.
- 2 Press the ADD button.
- 3 Repeat the procedure for each channel you want to add to the scan list.

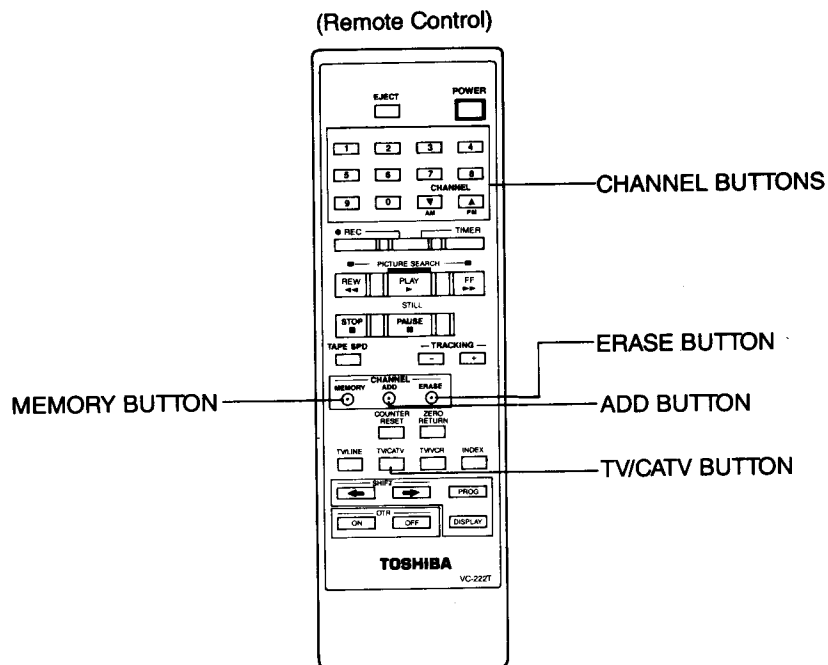

Operating the FS Tuner

This VCR has an FS (Frequency Synthesized) tuner and is designed to receive the following TV signals and CATV signals. This VCR can select CATV signals easily.

- I, Broadcast TV signals.
- II, CATV signals
 - 1. STD (standard) Cable TV signals.
 - 2. HRC (Harmonic Related Carriers) Cable TV signals.
 - 3. IRC (Incremental Related Carriers) Cable TV signals. IRC is also called ICC (Incremental Coherent Carriers.)
 - 4. PHRC (Pivoted Harmonically Related Carriers) Cable TV signals.
 - 5. MPC (Multi Pivoted Carriers) Cable TV signals.

Setting the CATV mode

Press the TV/CATV button to display the CATV indicator and the VCR changes to the CATV mode to receive the CATV signals.

To Select CATV Signals

This VCR is designed to select CATV signals automatically.

To Select Channels

1. USING THE CHANNEL BUTTONS (on the Remote Control)
 - (1) To select Channels 2 through 9, For example, press 0 and 4 . Channel 4 will be selected immediately.
 - (2) To select Channels 10 through 99, the two-digit entry must be used. Example; press 3 and 5 . Channel 35 will be selected immediately.
 - (3) To select channels 100 through 125, the three-digit entry must be used. Example; press 1 , 1 and 4 . Channel 114 will be selected immediately. If the third digit is not pressed within two seconds, channel 11 will be selected.

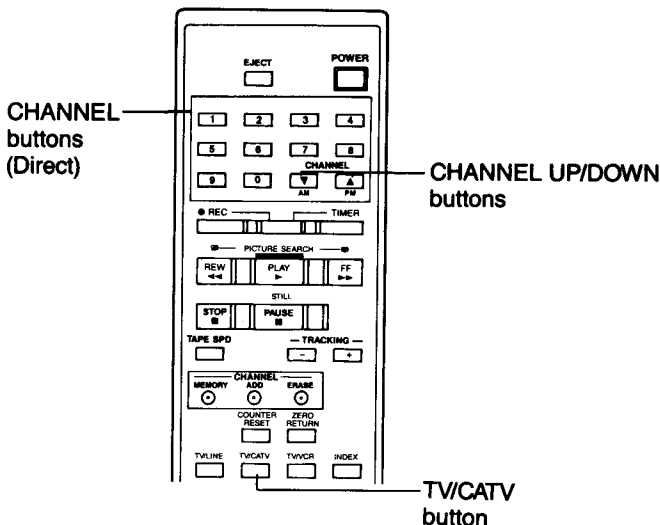

2. USING THE CHANNEL UP ▲ / DOWN ▼ BUTTONS (inside the console at the front panel or Remote Control)

Press and release the CHANNEL UP ▲ / DOWN ▼ button. The channel steps up or down automatically and stops at the next active channel. It will not stop at inactive channels. If you want to select the next active channel, press the button again.

(1) TV mode

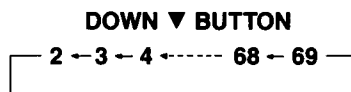

(2) CATV mode

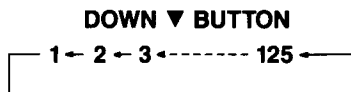
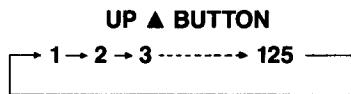

INSTALLATION AND MAINTENANCE

CHANNEL REFERENCE CHART

NUMBER ON THIS VCR		2	3	4	5	6	7	8	9	10	11	12	13
CORRESPONDING CHANNEL NUMBER	Broadcast TV	2	3	4	5	6	7	8	9	10	11	12	13
	CATV STD (HRC/IRC)	2	3	4	5(A-7)	6(A-6)	7	8	9	10	11	12	13

14	15	16	17	18	19	20	21	22	23	24	25	26	27	28	29	30	31	32	33	34	35	36	37	38
14	15	16	17	18	19	20	21	22	23	24	25	26	27	28	29	30	31	32	33	34	35	36	37	38
A	B	C	D	E	F	G	H	I	J	K	L	M	N	O	P	Q	R	S	T	U	V	W	AA (W+1)	BB (W+2)

39	40	41	42	43	44	45	46	47	48	-----	'69	-----	125	1
39	40	41	42	43	44	45	46	47	48	-----	69	-----	125	1
CC (W+3)	DD (W+4)	EE (W+5)	FF (W+6)	GG (W+7)	HH (W+8)	II (W+9)	JJ (W+10)	KK (W+11)	LL (W+12)	-----	69 (W+33)	-----	125 (W+84)	1 (A-8)

Notes:

If you selects any channel which is not on the channel reference chart by the direct key on the Remote Control, the VCR will select CH2 in the TV mode and CH1 in the CATV mode.

Using the Video Cassette

Only video cassettes with the **VHS** marks can be used with this VCR. Unlike audio cassettes, only one side of a video cassette can be recorded on.

Tape Speed

Recording: Tapes can be recorded at two different speeds, SP (Standard Play; records 3.34 cm/sec.) and SLP (Super Long Play; records 1.11 cm/sec.) You select the speed you prefer using the TAPE SPEED button. Selected speed mode will show up on the TV screen. The basic difference between these speeds is that the SLP mode allows you to get more footage on your tape. Although this is economical, the quality of the image is not as good as recordings made in the SP mode.

Playback: There are three possible speeds for playback; SP, LP, SLP. The appropriate speed will be chosen automatically by the VCR.

Applicable Speeds

Mode	Speed	SLP	LP	SP
Recording		0	—	0
Playback		0	0	0

Different types of cassettes and maximum recording times

Video Cassette Record Mode	T-160	T-120	T-60	T-30
SLP	480 min	360 min	180 min	90 min
SP	160 min	120 min	60 min	30 min

(EXAMPLE: With a T-160 video cassette you can record 480 min. of footage at the SLP speed or 160 min. at the SP speed. As you have probably noticed the code T-160 denotes the normal length of the tape at the SP speed.)

Important: When an important recording is to be made, first make a test recording to confirm that picture and sound normal.

Recording Over Old Tapes

You can record over old tapes and the old recorded picture and sound will be erased completely.

Similar to audio cassettes, you cannot record over tapes which have had their safety tabs removed. Removing the tab is a safeguard against accidentally erasing important recordings.

1. To remove the safety tab snap it off with a screwdriver as shown in Fig. 1.
2. To record over a tape without a safety tab all you need to do is cover the opening with a piece of adhesive tape as shown in Fig. 2.



Fig. 1



Fig. 2

Inserting a Cassette

When a tape is inserted the VCR will automatically turn on.

1. Push the tape in with your finger until it is pulled in automatically and clicks into place as shown in Fig. 3.
2. Make sure that you insert the cassette sideways and with the "windows" facing up as shown in Fig. 4.
3. Do not insert hand(s) or any foreign object(s) into the cassette compartment. Otherwise, injury may result (be especially careful with children) or damage may occur to the VCR.

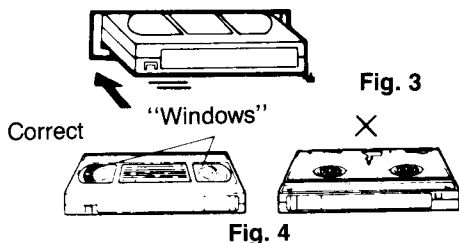

Fig. 3

Fig. 4

Removing a Cassette

1. Press the EJECT button. The tape will be ejected automatically.
2. Pull the tape out as shown in Fig. 5.

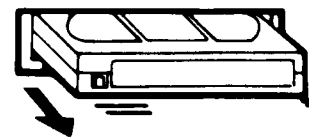
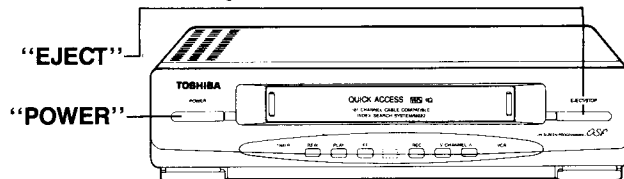

Fig. 5



PLAYBACK

Basic Playback

① Cassette compartment

Load the tape for playback, then this VCR will be automatically turned on.
(If the tape with the safety tab removed is loaded, the AUTO PLAY function operates to start playing back the tape automatically.)

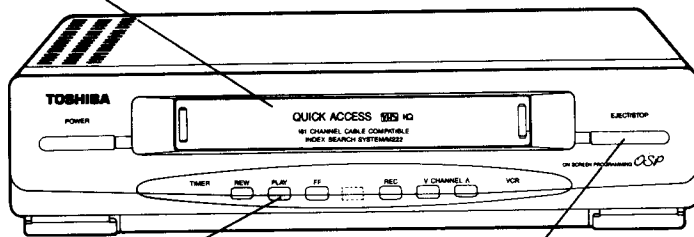

② PLAY button

Press **PLAY** button.
Once this button is pressed, tape playback starts.
When the tape is played back to the end, it will be automatically rewound to the beginning.

③ EJECT/STOP button

Press **EJECT/STOP** button to stop playback.

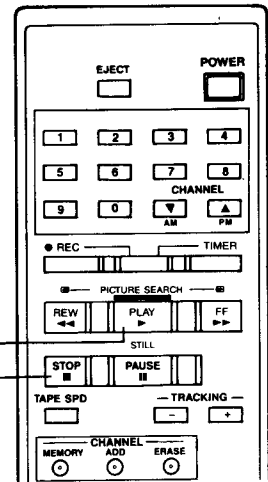

AUTO PLAY

When the tape with the safety tab removed is loaded, the following operations automatically start.

- **Auto Playback**
This operation automatically plays back the tape.
- **Auto Rewind**
This operation automatically rewinds the tape when tape playback comes to the end.

Note that Auto Play is cancelled when the operation button is pressed during playback.

Note:

- Basic playback is possible in all three modes, SP, LP, SLP.

Auto Repeat

VCR plays 10 times repetition from tape start to end.

- ① Load the cassette tape.
Press the PROG button, then MENU will appear on TV screen.

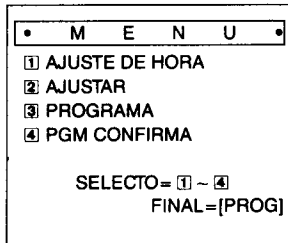
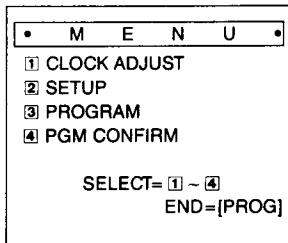

(SPANISH SCREEN)

- ② Press the 2 button, then SET UP will appear on TV screen.

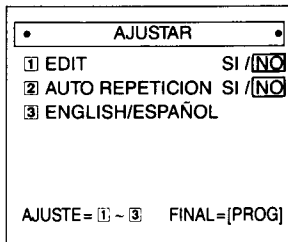
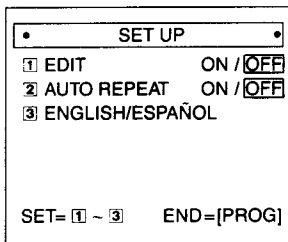

(SPANISH SCREEN)

- ③ Press the 2 button, select the AUTO REPEAT ON function.

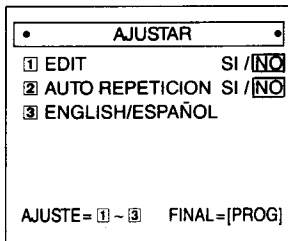
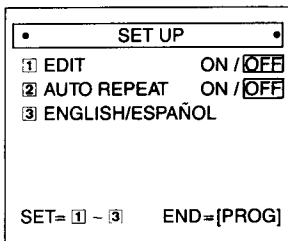

(SPANISH SCREEN)

- ④ SET UP and MENU screen is completed.
⑤ Press PROG button twice, then normal screen will appear.
⑥ Press the PLAY button, playback will begin.
⑦ If it becomes tape end from PLAY mode, then it operates auto rewind.
Also it becomes tape start point, second play operates automatically.
At the end of 10 times play, if it becomes auto rewind to tape start point, AUTO REPEAT function goes off after become stop mode.

RECORDING

Basic Manual Recording

① **Cassette compartment**
Load the tape into this compartment for recording. The VCR is turned on automatically.

② **TV/VCR button**
Pressing the TV/VCR button turns the VCR indicator on the VCR on or off. Details are on page 4.

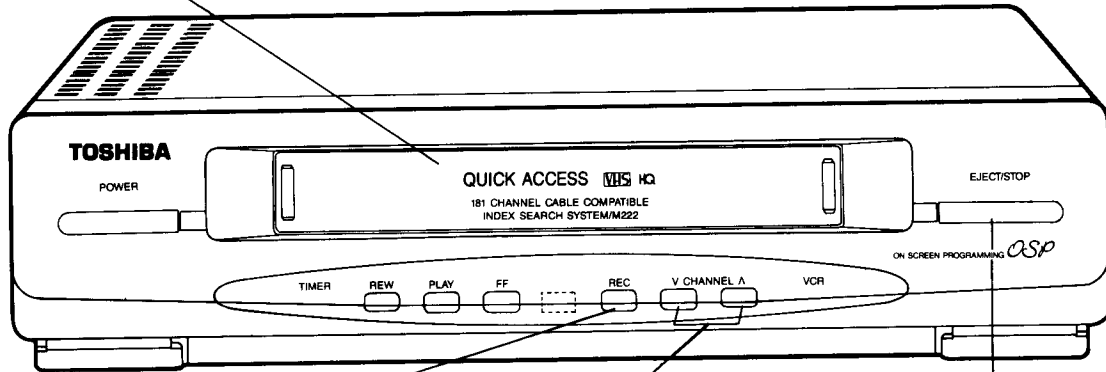

⑥ **EJECT/STOP button**
Press the **EJECT/STOP** button to stop recording. If the tape is recorded to its end, it is rewound automatically.

⑤ **REC button**
Press the **REC** button. The REC indicator on the VCR lights and recording starts.

④ **CHANNEL buttons**
Press the **CHANNEL** button to select the desired channel for recording.

③ **TAPE SPEED button**
Press the **TAPE SPEED** button on the remote control, select the recording speed (SP/SLP). Each time the button is pressed.

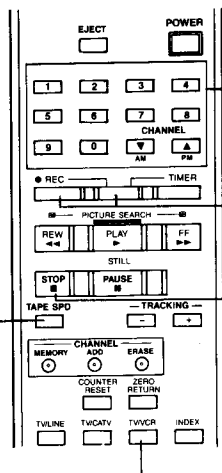

■ PAUSE/STILL button

Use this button to stop recording temporarily. This enables you to skip recording unnecessary parts of a program (such as commercial messages).

1. Press the **PAUSE/STILL** button during recording and recording is stopped temporarily. However, since the TV resumes operating, the picture and sound of the program can be received.
2. Press the **PAUSE/STILL** button to continue recording.

Note: If the VCR pauses for more than 5 minutes, it automatically enters the stop mode to protect the tape.

Recording a TV Program While Watching Another or Nothing

- Use the following procedure to watch another TV program while recording a TV program: Press the TV/VCR button on the remote control. Select the desired channel on TV. The TV screen displays the selected program while the VCR continues recording. The VCR continues recording even if the TV is turned off.
- And when TV is turned off, the TV/VCR button in step 2 is not necessary.

Notes:

- Basic Manual Recording is possible only in the SP and SLP modes.
- The recorded pictures on the tape may be distorted around where the **PAUSE/STILL** button is used. This is not a malfunction.
- Since channel lock function operates during recording, TV channels cannot be changed directly. To change the channel, press the **PAUSE/STILL** button first. If the **PAUSE/STILL** button is pressed again, a TV program in a new channel can be recorded.

COUNTER FUNCTION

Linear Time Counter Function

Since the VCR employs a linear time counter, it can indicate to the second the elapsed time of the tape running.

- ① Load a cassette into the cassette compartment. The VCR is turned on automatically.
- ② Press the DISPLAY button on the remote control.
- ③ Press the RESET button on the remote. The linear time counter indicates "CH00M00S".

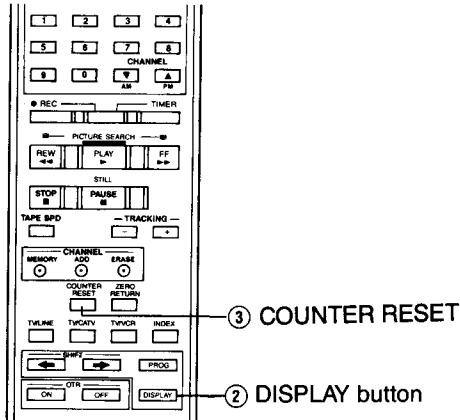

- ④ Activate the desired operation such as playback, recording, rewinding, or fast forwarding. The linear time counter indicates the real time of how long the tape has been running.

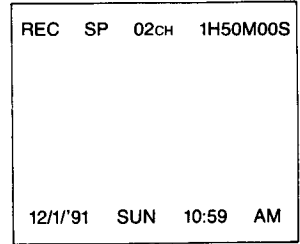

EXAMPLE

(In the recording mode, tape has been running for 1 hour 50 minutes).

Notes:

- Removing the cassette by using the **EJECT** button on the remote control returns the counter to "0H00M00S".
- The counter stops at tape sections where no program is recorded during fast forwarding or rewinding.
- The counter read does not change at blank tape sections.

Zero Return Function

This function enables you to stop the tape at around the counter read "0H00M00S" during rewinding or fast forwarding.

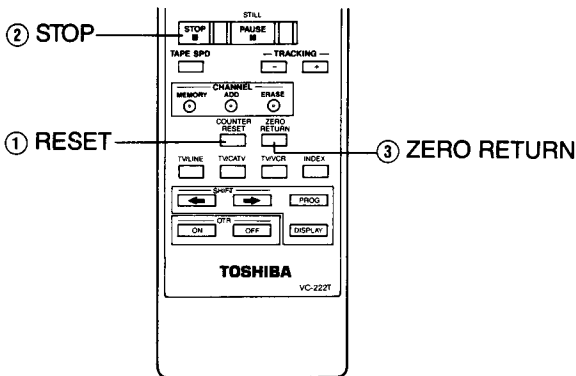

- ② Press the **STOP** button to stop the tape when recording or playback is completed.

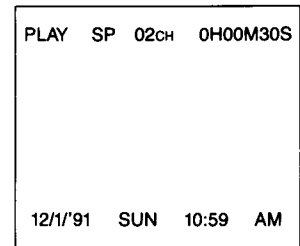

- ③ Press the **ZERO RETURN** button. Tape is rewound to near the counter read "0H00M00S". The zero return function can be used only in the stop mode.

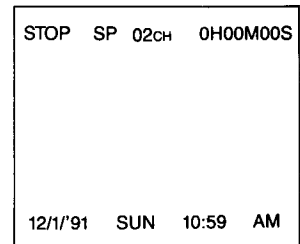

Press the **RESET** button at a scene you want to watch again during recording or playback. The screen counter reads "0H00M00S".

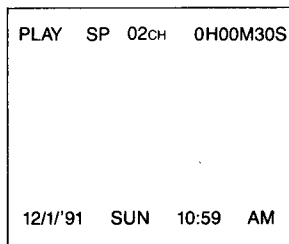

If the tape is rewound beyond the counter read "0H00M00S", press the **ZERO RETURN** button, and tape is fast forwarded to stop at around the counter read "0H00M00S".

Note:

- The VCR does not stop exactly at the counter read zero (0H00M00S), but stops around zero, depending on the tapes you use.

CONVENIENT FUNCTIONS

AUTO SEARCH

Index

You can easily search the recorded program using the index signal registered together with it on the tape.

■ Index Search

This function plays back the tape around where the index signal is registered for about 5 seconds while fast forwarding or rewinding. (This function is operable using the remote control.)

■ Skip Search

This function fast forwards or rewinds the tape to the point with the specified index signal to start playback from there automatically. (Specifying the index signal can be operated with the CHANNEL button on the remote control.)

Index Register

There are two ways to register INDEX signals: automatically and manually.

■ Auto Register

Press the recording button during the stop mode and the index signals are registered automatically.

Auto register can be operated during one touch timer or timer programming recording.

■ Manual Register (using the remote control)

During recording, index signals can be registered at the desired sections of the tape with the remote control.

How to Register Index Signal during Recording

(Remote Control)

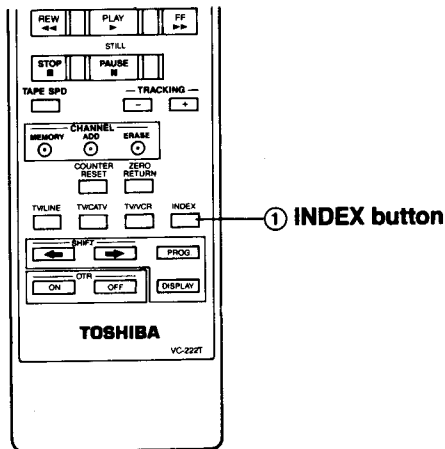

Press the **INDEX** button during recording, then the "INDEX MARK" will only blinking 2 seconds on the screen.

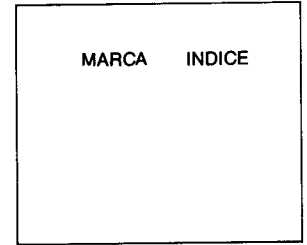
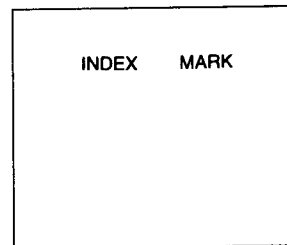

(SPANISH SCREEN)

Notes:

- When registering or erasing the index signals is operated on the tape recorded on other VCRs, its pictures may be distorted.
- When registering index signals at 2 or more sections on the tape, certain intervals are needed: more than 1 min. in SP mode and more than 3 min. in SLP mode.

Index Search

(Remote Control)

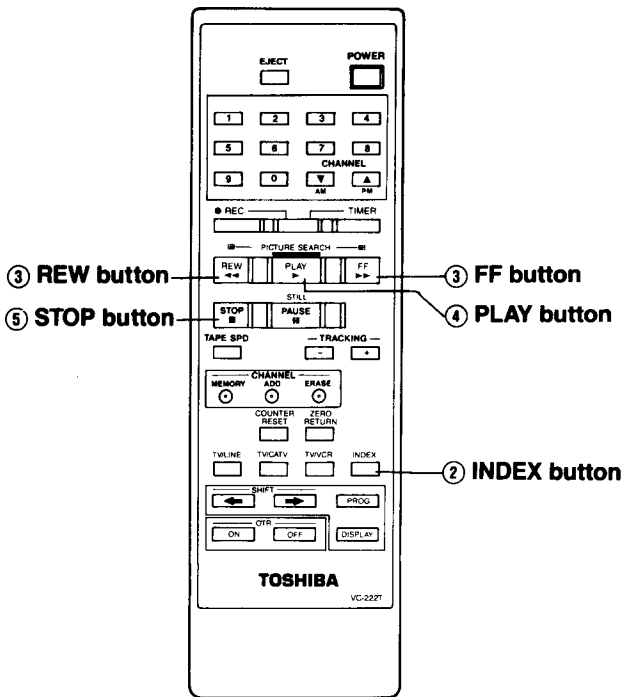

② Press the **INDEX** button.

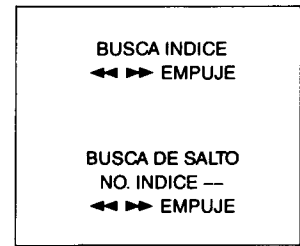
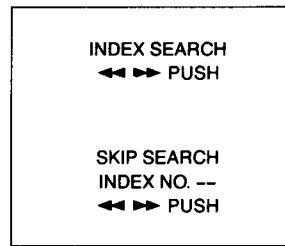

(SPANISH SCREEN)

③ Press either the **FF** button or **REW** button within 8 seconds.

The VCR starts to fast forward or rewind the tape, playing it back around the section where the index signal is registered for 5 seconds. This operation is repeated until the end of the tape is reached.

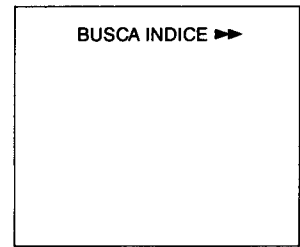
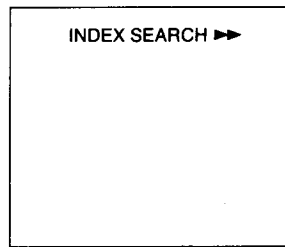

(SPANISH SCREEN)

① Load the tape with the index signals, then play back or stop it depending on preference.

④ Press the **PLAY** button when the desired program is searched. "INDEX SEARCH" on the screen goes off.

If the button is not pressed, fast forwarding or rewinding resumes while the next index signal is being searched.

⑤ Press the **STOP** button to stop playback.

Notes:

- Press the **PLAY** button to stop index search.
- Index search may not be applied to the first program recorded on the tape.
- Index signal may not find in accordance with the tape condition.

CONVENIENT FUNCTIONS

Skip Search

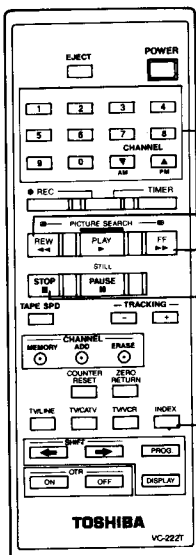

③ Press the **CHANNEL** buttons to specify the index signal within 8 seconds. The VCR indicator comes on and the index signal number is displayed on the screen.

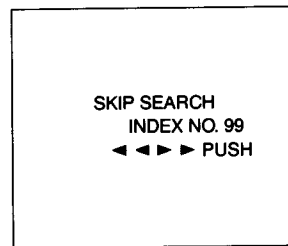

(SPANISH SCREEN)

④ Within 8 seconds, press the **FF** button if the desired index signal is in the program ahead, and the **REW** button if it is in the program behind.

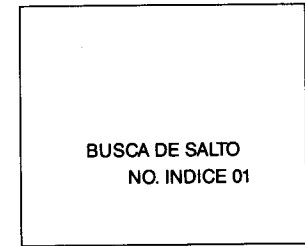
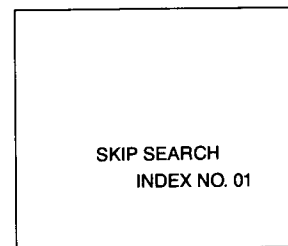

(SPANISH SCREEN)

When the tape comes to the specified index signal it is played back automatically. The counter returns to the elapsed-time-on-tape read from the index signal read.

⑤ Press the **STOP** button to stop playback.

Enter skip search from the stop or playback mode.

- ① Load the tape with the index signals, then play back or stop it depending on preference.
- ② Press the **INDEX** button.

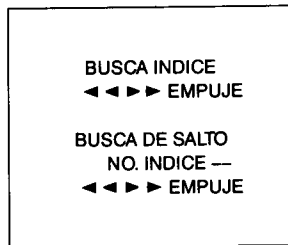
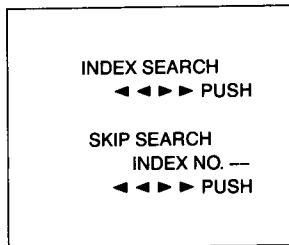

(SPANISH SCREEN)

CONVENIENT FUNCTIONS

Numbering the index signals

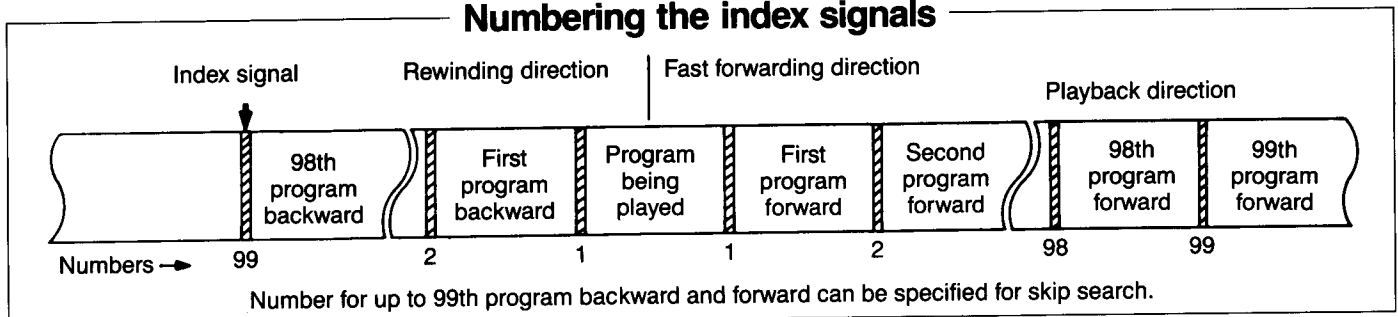

Notes:

- Press the **PLAY** or **STOP** button to stop skip search.
- Skip search may not work for the first program on the tape.
- Index signal may not find in accordance with the tape condition.
- The counter read for numbers reduces by one each time an index signal is skipped.

SPECIALIZED EFFECTS

Picture Search

This function lets you fast forward (FF) and reverse (REW) at high speed while the picture is played back on the screen. Its main purpose is to allow you to quickly locate a particular scene or segment on the tape.

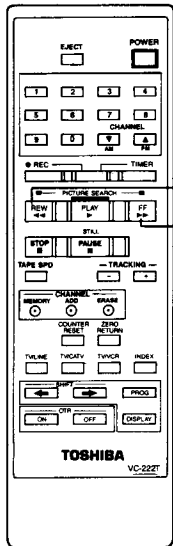

REW button
FF button

■ **ACCEL search**
If you keep pressing the FF or REW button during playback, the searching speed will be increased to 7 times (SP speed only) or 21 times (SLP speed only) normal speed.

■ **FF button**
During playback press this button without pressing STOP. The rewinding or fast-forwarding frames will be shown on your TV screen at 5 times (SP speed only) or 9 times (SLP speed only). Press the **PLAY** button and the VCR will return to the normal playback mode.

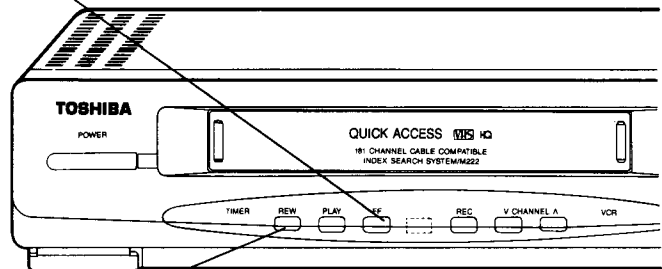

■ **REW button**
During playback press this button without pressing STOP. The rewinding or fast-forwarding frames will be shown on your TV screen at 5 times (SP speed only) or 9 times (SLP speed only). Press the **PLAY** button and the VCR will return to the normal playback mode.

Forward Picture Search and Reverse Picture Search can be entered not only from Play mode but also from other modes e.g.: Fast-Forward (FF), Rewind (REW), Forward or Reverse Picture Search, and still. Each time the FF or REW button is pressed, a mode is entered in the following sequence.

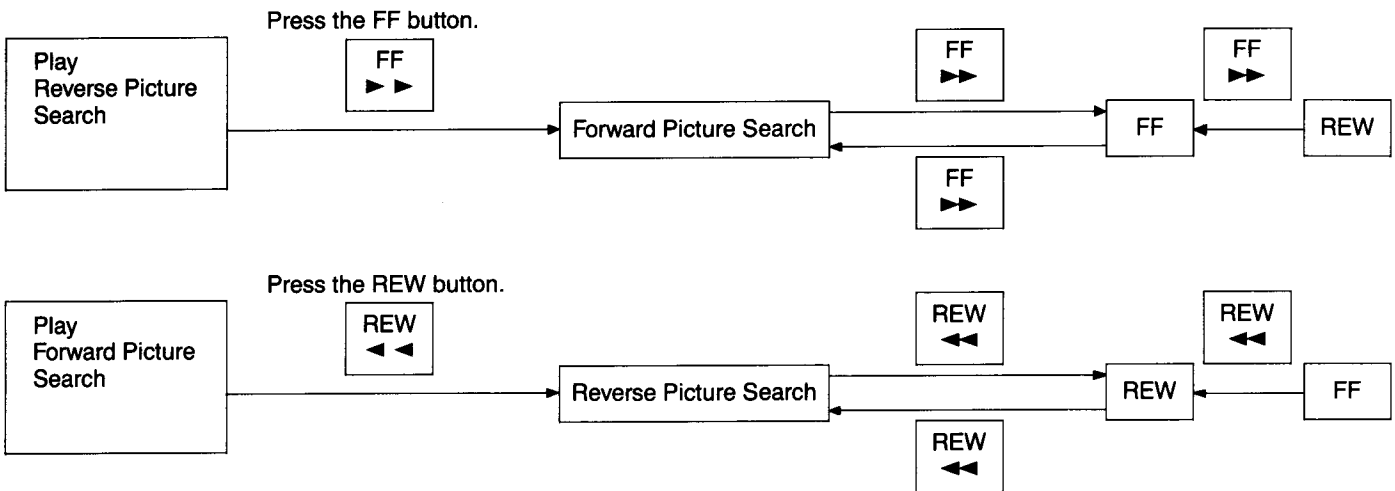

Notes:

■ During Picture Search the sound is muted and several horizontal noise bars appear across the screen as shown in Figure (1). This is a normal operation. If noise patterns appears on your screen as shown in Figures (2) and (3), adjust the appropriate horizontal/vertical controls on your TV set.

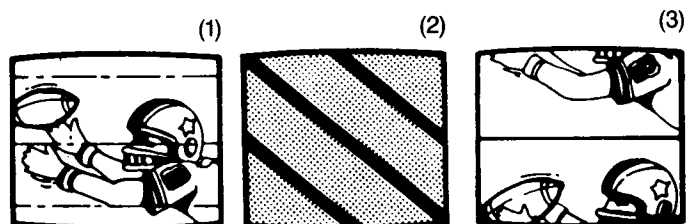

Still Frame (SLP mode only)

This function enables you to freeze a picture, so that you can watch important scenes closely.

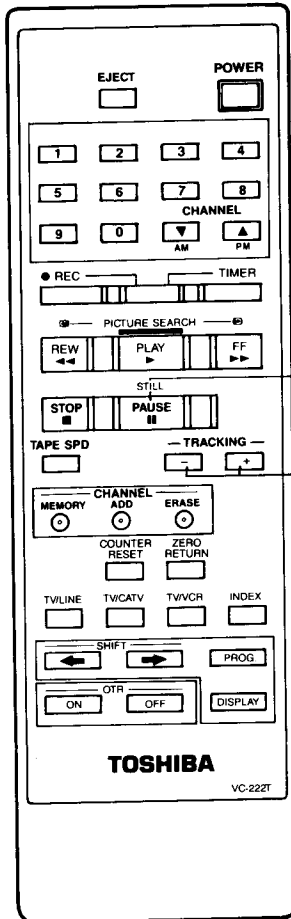

■ PAUSE/STILL button

■ V-LOCK button

■ PAUSE/STILL button

Press the **PAUSE/STILL** button during playback to freeze the picture. Press it again to return to normal playback.

Note:

- Still frame is cancelled automatically after about 5 minutes operation to return to normal playback.
- Streaks within the picture are normal. (Best results are on tapes recorded at the SLP speed. More about that later).
- There will be no sound.
- If the picture is vertically unstable during still mode, adjust with the V-LOCK adjustment on the remote control, (see page 6).

TIMER RECORDING

One Touch Timer Recording

One Touch Timer function lets you program the VCR to record a TV program either immediately or within 24 hours from the present time. One Touch Timer recording can be done only with the power on. Please read the instructions below.

One Touch Timer Recording I (Immediate Recording)

This procedure is used when you want to begin recording immediately. This is useful when you are in a hurry.

EXAMPLE: To record channel 4 starting from now until 11:30 p.m.
(example with present time: 10:05 p.m., Thursday) Tape speed SP.

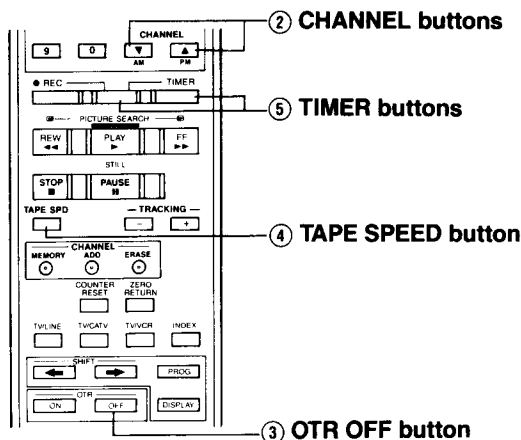

- ① Load a cassette with the safety tab into the VCR.
- ② Press the **CHANNEL** button to set to channel 4.
- ③ Press the **OTR OFF** button to set the recording **OFF** time.
When the button is pressed once: 10:30 p.m.
pressed 3 times: 11:30 p.m.
- ④ Set the **TAPE SPEED** button to SP.
- ⑤ Press the **TIMER** buttons and the recording begins.
When recording is completed, the VCR, turns off automatically.

• ONE TOUCH RECORDING •	
(Channel)	04
(Speed)	SP
(Time Off)	10:30 PM
TIMER MODE=[TIMER]	

• GRABACION CON UN TOQUE •	
(Canal)	04
(Velocidad)	SP
(Apagar)	11:30 PM
MODE DE TIEMPO=[TIMER]	

(SPANISH SCREEN)

Notes:

- Press the **OTR OFF** or **TIMER** button within 8 seconds following the previous step. Otherwise, one touch timer recording is cancelled.
- During one touch timer recording, pause or other operations do not work.
- During this recording, you cannot change the recording time.
- To cancel one touch timer recording, press the **POWER** or **TIMER** buttons.
- You can enter one touch recording from any mode. The tape section between the last program recorded and current program being recorded is distorted for about 10 seconds.
- One touch recording has priority when one touch timer and programmed timer recordings are overlapped.

One Touch Recording II (Within 24 hours)

Use this procedure when you want to make a recording within twenty-four hours and do not have the time to set the Programmable Timer in the conventional way.

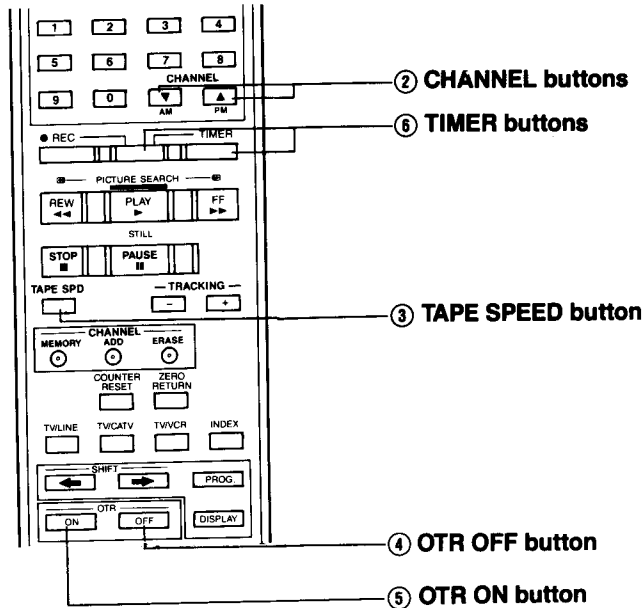

EXAMPLE: To record channel 4 starting from 10:30 A.M. to 11:00 A.M.
(example: present time 7:10 A.M.) tape speed SP.

- ① Load a cassette with the safety tab into the VCR.
- ② Press the **CHANNEL** buttons to set to channel 4.
- ③ Set the **TAPE SPEED** button to SP.
- ④ Press the **OTR ON** button. Set the ON time to "10:30 A.M."

• ONE TOUCH RECORDING •	
(Channel)	04
(Speed)	SP
(Time On)	10:30 AM
(Time Off)	--:-- AM

• GRABACION CON UN TOQUE •	
(Canal)	04
(Velocidad)	SP
(Encender)	10:30 AM
(Apagar)	--:-- AM

(SPANISH SCREEN)

- ⑤ Press the **OTR OFF** button to set the OFF time at "11:00 A.M.". Pressing the button once will set the time ahead thirty minutes. Recording time is limited to four hours.

• ONE TOUCH RECORDING •	
(Channel)	04
(Speed)	SP
(Time On)	10:30 AM
(Time Off)	11:00 AM
TIMER MODE = [TIMER]	

• GRABACION CON UN TOQUE •	
(Canal)	04
(Speed)	SP
(Encender)	10:30 AM
(Apagar)	11:00 AM
MODE DE TIEMPO=[TIMER]	

(SPANISH SCREEN)

- ⑥ Press the **TIMER** buttons. The VCR is turned off and enters one touch timer recording stand-by mode.
- ⑦ Recording starts at the set time.

When the button is
pressed once: 7:30 a.m.
pressed twice: 8:00 a.m.
pressed 7 times: 10:30 a.m.

■ **OTR OFF**

1. Immediate start OTR OFF.

Each time this button is pressed, the time indicator advances by 30 minutes. The recording OFF time can be set up to 4 hours ahead with it.

Example: The present time is 8:20

When the button is pressed

once: 8:30 p.m.;

twice: 9:00 p.m.;

three times: 9:30 p.m.;

If pressed nine times one touch timer recording is cancelled. Pressed the **TIMER** buttons within 8 seconds after setting the recording OFF time.

2. Delayed start OTR OFF

Each time you press the OTR OFF button the recording time is extended as follows.

1st Press	30 minutes
2nd Press	1 hour
3rd Press	1-1/2 hour
4th Press	2 hours
5th Press	3 hours
6th Press	4 hours
7th Press	initial state (—:—)

■ **OTR ON**

Each time this button is pressed, the time advances by 30 minutes. The recording ON time within 24 hours can be set with this button.

Example: The current time is 7:10 a.m.

When the button is pressed

once: 7:30 a.m.;

twice: 8:00 a.m.;

three times: 8:30 a.m.;

Note:

- To cancel the recording ON time or one touch recording mode; Press the POWER or TIMER buttons.
-

When a power failure occurs during one touch timer recording

- When a power failure has occurred "12:00 AM" blinks on the TV screen, since the programmed contents have been cleared, reset the clock and timer recording.

Programmable Timer Recording

The Programmable Timer lets you record up to 8 different programs over a period of one year when you are not at home or are busy. All you have to do is set the timer to the appropriate day, time and channel for the program you want to record. The buttons for setting the Programmable Timer are on the REMOTE CONTROL. You can program the timer to do following:

Setting the Programmable Timer.

This example is for recording the program on Channel CATV 125, to be broadcast from 9:02 p.m. to 10:50 p.m. on Jun 30, 1991 (6/30/91) as program 1 in the SP mode. (Normal Program. The present time is 10:10 a.m. Jan 1st. 1991)

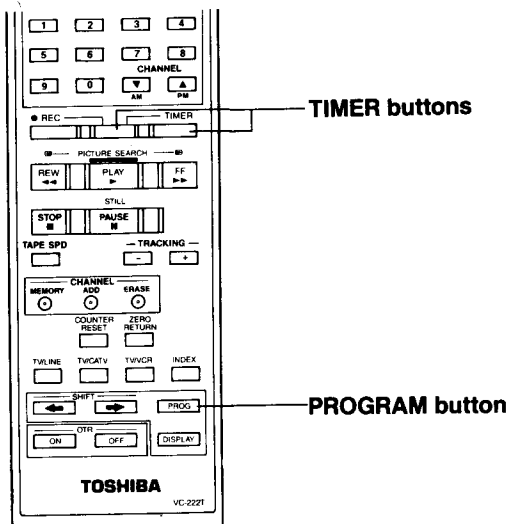

- 1 Load a cassette with a safety tab into the cassette compartment. The VCR is turned on automatically.
- 2 Check the display if the current time is set correctly.
- 3 Press the PROGRAM button. The programming "menu" appears on the TV screen.

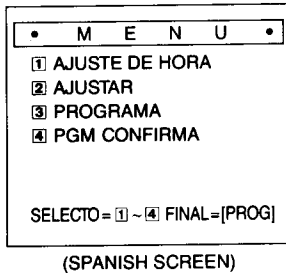
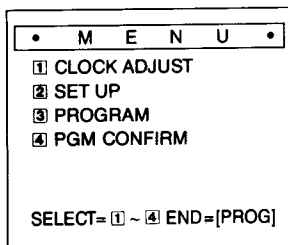

- 4 Press the "3" button on the Remote Control. All 8 program numbers will be flashing because none of them have been used.

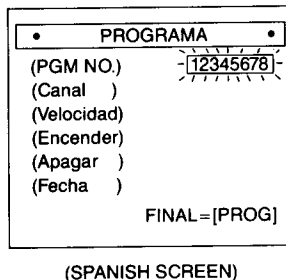
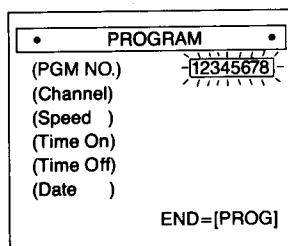

- 5 Press the "1" button on the Remote Control, to select the program 1. The display will prompt you to select a channel number.

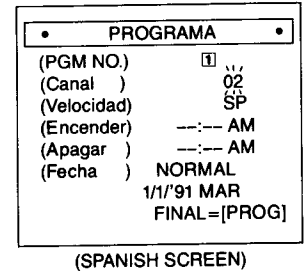
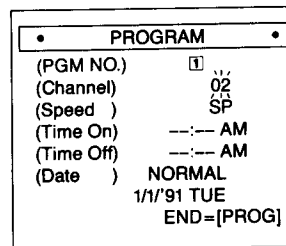

- 6 Press the TV/CATV and CHANNEL buttons 1, 2, 5 to set the channel to C125.
- 7 Press the "1" button to set the recording mode to SP. The display will prompt you to enter the recording on time.

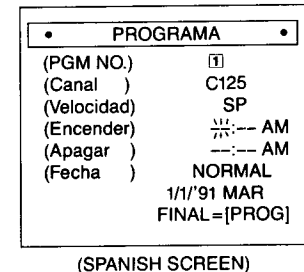
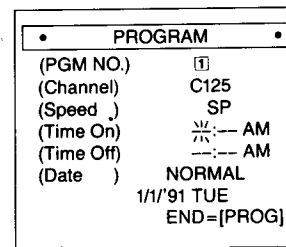

- 8 Press "0" "9" "0" "2" buttons to set the recording on time. The display will prompt you to select either AM or PM.
- 9 Press the CHANNEL up (▲) button to set the recording on time to P.M. The display will prompt you to enter the recording off time.

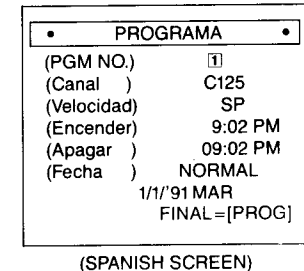
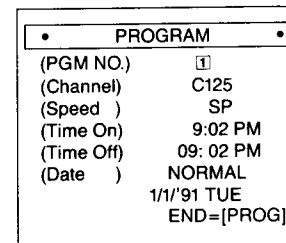

- 10 Press "1" "0" "5" "0" buttons to set the recording off time to 10:50.
- 11 Press the CHANNEL up (▲) button to set the recording off time to P.M.

PROGRAM	
(PGM NO.)	1
(Channel)	C125
(Speed)	SP
(Time On)	9:02 PM
(Time Off)	10:50 PM
(Date)	NORMAL 1/1/91 TUE
NORMAL=	1 DAILY= 2
WEEKLY=	3 END=[PROG]

PROGRAMA	
(PGM NO.)	1
(Canal)	C125
(Velocidad)	SP
(Encendev)	9:02 PM
(Apagar)	10:50 PM
(Fecha)	NORMAL 1/1/91 MAR
NORMAL=	1 DIARIO= 2
SEMANAL=	3 FINAL=[PROG]

(SPANISH SCREEN)

- To set the normal program, press the "1" button.
- Daily Program: Sets the time for recording which is executed at the same time Monday through Friday.
 - Weekly Program: Sets the time for recording which is executed at the same time and the same day every week.

- 12 Press "0" "6" "3" "0" buttons to set the recording START DATE to Jun 30.

PROGRAM	
(PGM NO.)	1
(Channel)	C125
(Speed)	SP
(Time On)	9:02 PM
(Time Off)	10:50 PM
(Date)	NORMAL 6/30/91 SUN
TIMER MODE=	[TIMER]
END=	[PROG]

PROGRAMA	
(PGM NO.)	1
(Canal)	C125
(Velocidad)	SP
(Encender)	9:02 PM
(Apagar)	10:50 PM
(Fecha)	NORMAL 6/30/91 DOM
MODE DE TIEMPO=	[TIMER]
FINAL=	[PROG]

(SPANISH SCREEN)

- 13 Press the PROGRAM button.

MENU	
1	CLOCK ADJUST
2	SET UP
3	PROGRAM
4	PGM CONFIRM
SELECT=	1 ~ 4
END=	[PROG]

MENU	
1	AJUSTE DE HORA
2	AJUSTAR
3	PROGRAMA
4	PGM CONFIRMA
SELECTO=	1 ~ 4
FINAL=	[PROG]

(SPANISH SCREEN)

- This completes programming one program for timer recording. If no other program is necessary for timer recording, proceed to step 14.
- To program the remaining programs up to seven, repeat the procedure from step 3 to step 13.

- 14 Press the Timer buttons.
- The power goes off, and the VCR enters the timer recording stand-by mode. Recording starts automatically at the set time.

Confirming Programmed Contents

1. Press the PROGRAM button on the REMOTE CONTROL to display the programming menu.
2. Press the "4" button on the REMOTE CONTROL (PROGRAM CONFIRM).

CONFIRM	
1	C125CH 6/30 9:02 PM→10:50 PM SP
2	
3	
4	
5	
6	
7	
8	
CLEAR=	1 ~ 8 END=[PROG]

CONFIRMA	
1	C125CH 6/30 9:02 PM→10:50 PM SP
2	
3	
4	
5	
6	
7	
8	
LIMPIAR=	1 ~ 8 FINAL=[PROG]

(SPANISH SCREEN)

3. When you are finished, press the PROGRAM button.

Clearing the Programmed Contents

1. Press the PROGRAM button on the REMOTE CONTROL to display the programming menu.
2. Press the "4" button on the REMOTE CONTROL.
3. Press the "1~8" button.
4. When you are finished, press the PROGRAM button.

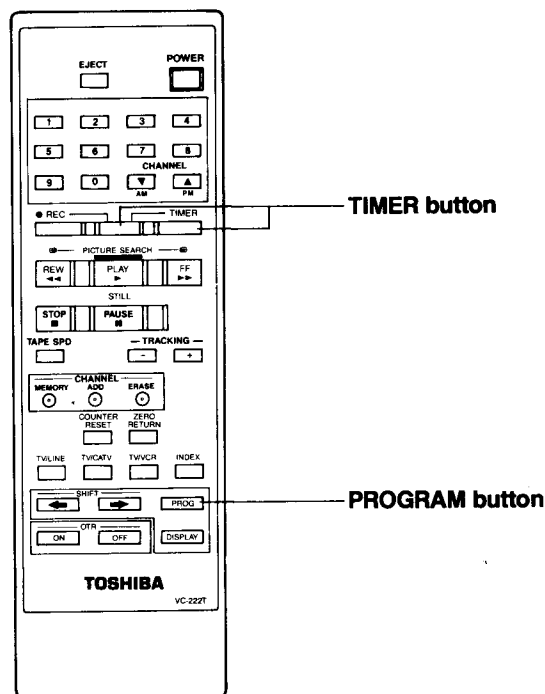

SPECIALIZED OPERATIONS

Overlap of Programs

If two programs programmed for timer recording overlap, the recording ON time of the second program has priority over the recording OFF time of the first program.

This section for the first program cannot be recorded.

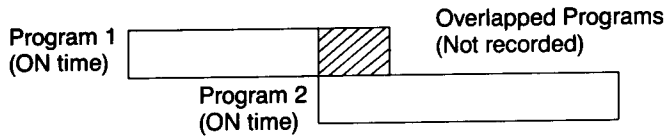

Power Failure during Timer Recording

- When a power failure has occurred, push the DISPLAY button on the remote control after back up time (30 seconds) "12:00 AM" on the screen blinking and recording is no longer possible. Reset the clock, then the programs.
- If a power has failed for a short period (within 30 seconds) the contents of the programs have not been affected. Check the current time is displayed correctly.

Using the VCR During Timer Stand-by for Normal Playback and Recording

You can use the VCR for normal playback and recording even when it is in the Timer Stand-by mode

1. Press the TIMER button
2. Press the POWER button to turn the VCR on.
3. Follow the normal procedures for recording and playback.
4. When you have finished using the VCR for normal purpose, press the TIMER button again and the VCR returns to the Timer Stand-by mode.

Changing the Program Contents

When this VCR is in the recording stand-by mode with the indicator on;

1. Press the TIMER buttons to cancel the timer recording standby mode.
2. Press the POWER buttons to turn the VCR on.
3. Press the PROGRAM button to display program menu.
4. Press the "3" button on the REMOTE CONTROL.
5. Press the program number you want to change.
6. Press the SHIFT buttons to move the cursor to the item you want to change.
7. Press the necessary buttons (Direct CHANNEL buttons, CHANNEL UP/DOWN buttons) corresponding to the desired contents to change.
8. Press the PROGRAM button.
9. Press the TIMER buttons again to reenter the recording stand-by mode.

Notes:

- If the cassette has the safety tab removed, it will be ejected if the TIMER button is pressed.
- The auto rewind function does not operate when the tape reaches the end in the Timer recording.
- To cancel the timer recording, press POWER or TIMER buttons.
- During timer recording, the pause mode cannot be operated.
- When normal timer recording is completed, the programmed contents are erased.

SPECIALIZED OPERATIONS

Copying VCR Recording

You can dub the tape for editing by connecting this VCR to another VCR.

Using this VCR for playback (see p. 25)

- ① This VCR: Set the EDIT ON/OFF function to "ON".
- ② Recording VCR: Press the record button, then the pause button to enter the recording pause mode.
- ③ This VCR: Press the **PLAY** button to activate play.
- ④ Recording VCR: Cancel the pause mode to activate recording.
- ⑤ Both VCRs: To terminate recording, press the stop button on both VCRs. Copying is completed.

Using this VCR for recording (see p. 27)

- ① Playing VCR: Set the EDIT ON/OFF function to "ON", if possible.
- ② This VCR: Press the **TV/LINE** and **REC** button, then the **PAUSE/STILL** button to enter the pause mode.
- ③ Playing VCR: Press the play button to activate play.
- ④ This VCR: Press the **PAUSE/STILL** button again to cancel the pause mode to start recording.
- ⑤ Both VCRs: To terminate recording, press the stop button on both VCRs. Copying is completed.

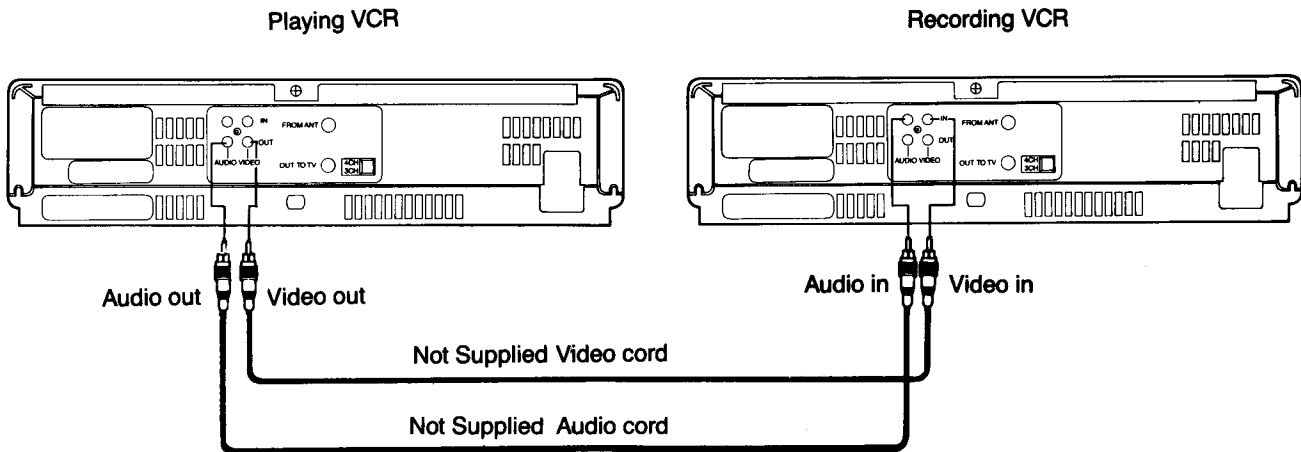

■ EDIT ON/OFF function

1. Press the program button.
2. To display SET UP screen, press the "2" button.
3. To display EDIT ON/OFF function, press the "1" button.

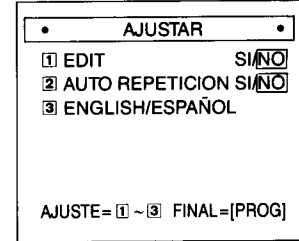
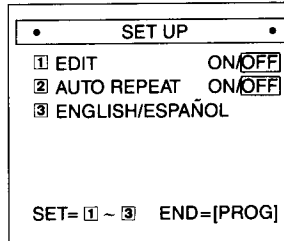

(SPANISH SCREEN)

When dubbing is completed, set the EDIT ON/OFF function to "OFF". If it remains at "ON" when the tape is played back, picture quality is not satisfactory.

WARNING: Tapes can only be copied and used in accordance with applicable copyright laws. But, if the tape is covered by a copyright, it is illegal to copy it and/or charge an entrance fee to set it.

Note:

- In general, picture quality deteriorates somewhat in the dubbed tape. It is best to use the SP mode.

OTHERS

Specifications

Power supply:	120V AC, 60Hz
Power consumption:	27W
External dimensions:	14.8×3.52×13.24 inches (W.H.D.) [370×88×331mm (W.H.D)]
Weight:	12.3 lb (5.6 kg)
Channels received:	VHF: Channels 2 – 13, UHF: Channels 14 – 69, CATV: Channels 1 – 125
Antenna input/output terminals:	VHF/UHF: 75 ohm F Type Connector
Signal system:	Standard NTSC
Recording/Playback system:	Recording: VHS format (SP, SLP), Playback: VHS format (SP, LP, SLP).
Cassette:	Video cassette with VHS mark
Tape speed:	SLP: 1.11 cm/second, SP: 3.34 cm/second
Video record/playback time:	SLP: 480 minutes, SP: 160 minutes (When T-160 video cassette is used.)
Fast forward/rewind time:	Within 6 minutes (When T-120 video cassette is used.)
Video input:	1 Vp-p, 75 ohm, unbalanced, negative sync, pin jack
Video output:	1 Vp-p, 75 ohm, unbalanced, negative sync, pin jack
Audio input:	Line input: –8 dBs more than 47K ohm, pin jack
Audio output:	Line output: –6 dBs less than 4.7K ohm, pin jack
Audio frequency range:	80 Hz – 12 kHz
Utilization conditions:	Temperature: 41°F to 104°F, Humidity: less than 80% RH
VHF output:	Channel 3 or 4, 66dB μ V
Time display:	12 hours digital display
Time precision:	Synchronized with the AC power frequency
Timer setting:	1 year, 8 programs
Remote control unit:	40 keys (with Direct Channel Select)

Designs and specifications are subject to change without notice.

QUICK REFERENCE

Installation

Use this page as reference when connecting your VCR with your TV set and various types of antennas. For detailed information, see the chapters entitled INSTALLATION. (see page 9 ~ 14)

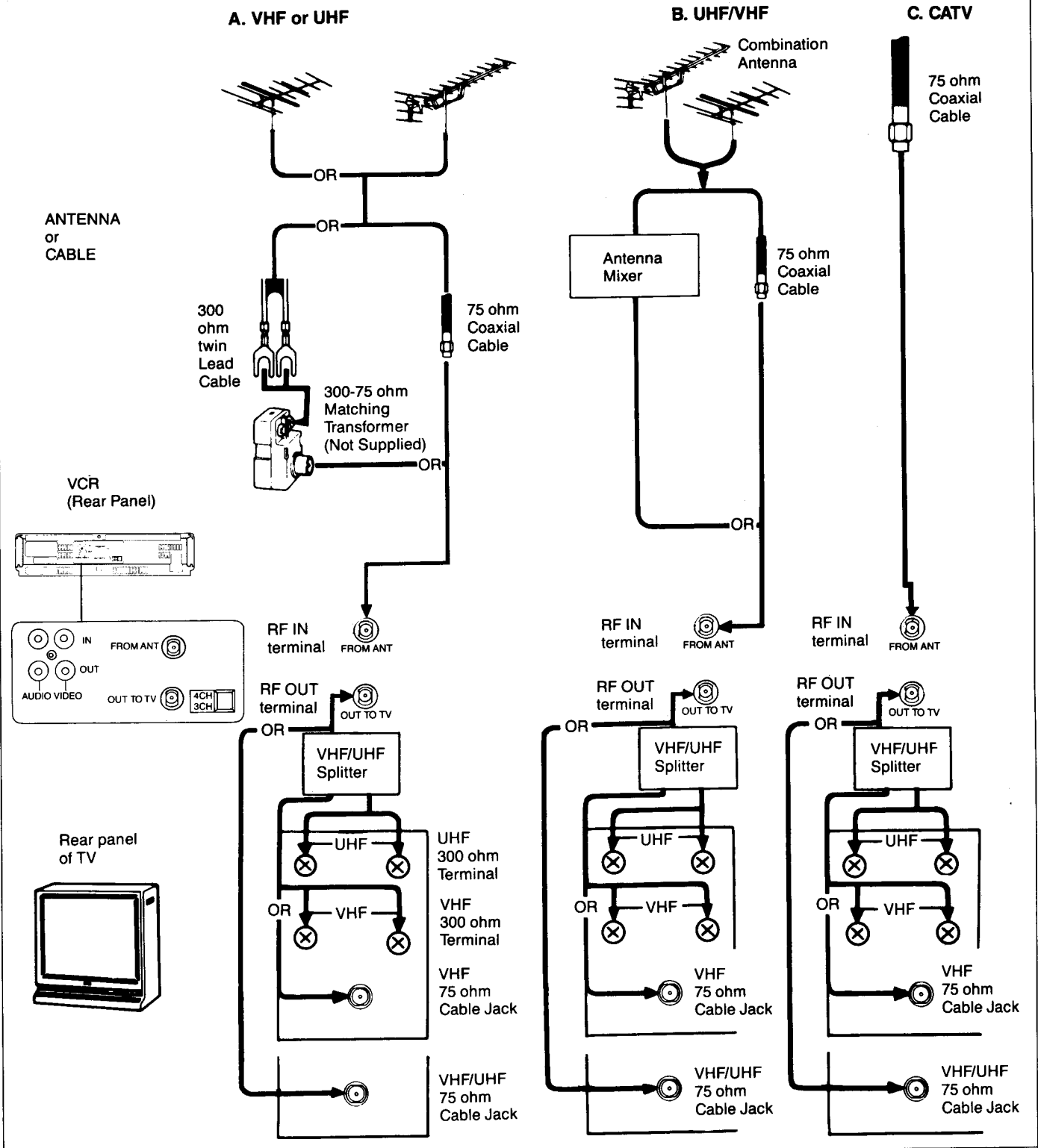

Operations

This card is to be used for quick reference to all basic procedures while you are actually using the VCR.

Playback	Manual Recording	Setting The Clock	Programmable Timer Recording
<ol style="list-style-type: none"> The tape will automatically begin playback if the record-protect (safety) tab on the cassette has been removed. If you press any other button while the tape is playing, the function is cancelled and you must press PLAY button ⑮. <ul style="list-style-type: none"> See p. 25 of Owner's Manual 	<p>(While watching same program)</p> <ol style="list-style-type: none"> Insert tape with tab. Set TV/VCR buttons ⑥ to VCR and turn TV channel to 3 or 4. Set channel to be recorded using VCR CHANNEL Select buttons ⑤. Press REC. button ④. <ul style="list-style-type: none"> See p. 27 of Owner's Manual 	<p>(While watching another program)</p> <ol style="list-style-type: none"> Insert tape with tab. Set TV/VCR button ⑥ to VCR and turn TV channel to 3 or 4. Set channel to be record with VCR CHANNEL Select buttons ⑤. Press REC. button ④. Set TV/VCR button ⑥ to TV. Use TV channel to choose the desired channel. 	<ol style="list-style-type: none"> Press PROGRAM button ① of remote control. Press CLOCK SET ① button ⑤. Set current day, hour and minute with c-e. Press PROGRAM button ① again. <ul style="list-style-type: none"> See p. 18 of Owner's Manual
			<ol style="list-style-type: none"> Follow steps 1-2 of Manual Recording. Check the display if the current time is set. Press PROGRAM button ① on the remote control. Press ③ button ③. Set channel with VCR CHANNEL select buttons ⑤. Set recording start time with buttons ③. Set recording end time with buttons ③. Press TIMER button ①. <ul style="list-style-type: none"> See p. 37 of Owner's Manual.

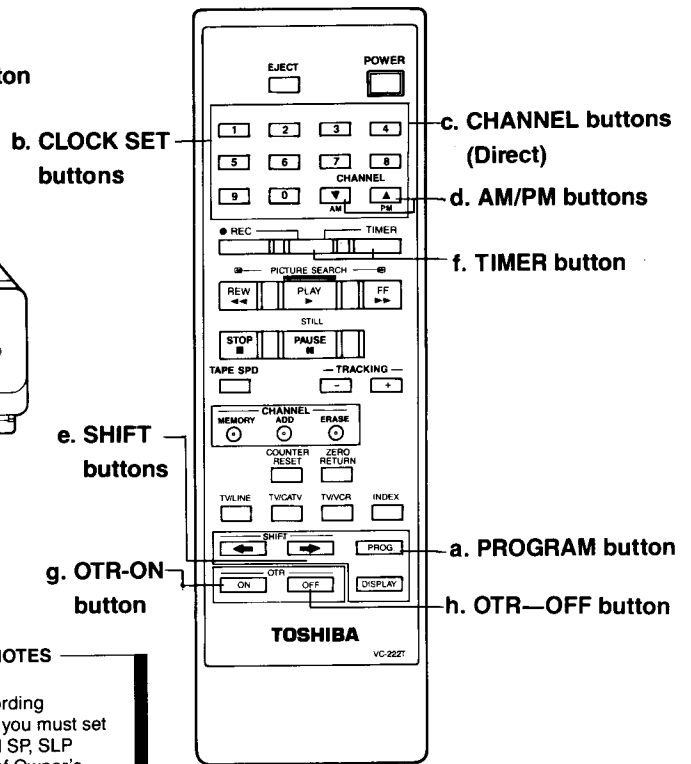
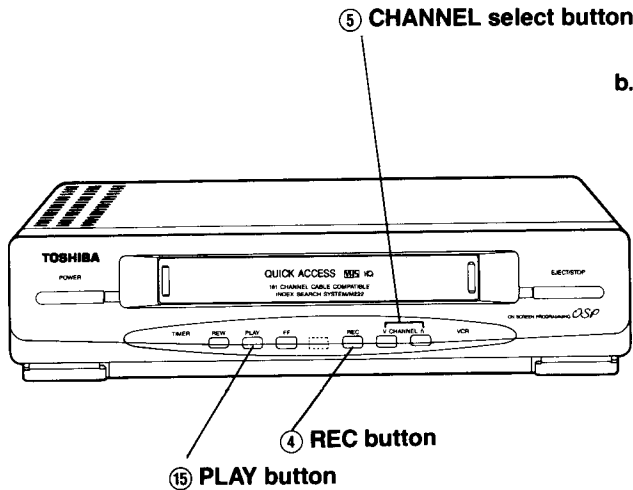

OTR Recording I	OTR Recording II	NOTES
<ol style="list-style-type: none"> Follow steps 1-3 of Manual Recording. Press OTR - OFF button ⑨ to set the time you want recording to end. (advances at 30 min. intervals from closest half hour.) Press TIMER button ① to begin recording immediately. <ul style="list-style-type: none"> See p. 34 of Owner's Manual. 	<ol style="list-style-type: none"> Follow steps 1-3 of Manual Recording. Press OTR - ON button ⑩ to set time for recording to begin within next 24 hours. Press OTR - OFF button ⑨ to set time for recording to end. Press TIMER button ① for stand-by until recording time. <ul style="list-style-type: none"> See p. 35 of Owner's Manual. 	<p>For all recording operations you must set tape speed SP, SLP</p> <p>See p. 27 of Owner's Manual.</p>

Before Calling Service Personnel

Check the following list of problems and remedies before calling service personnel. The problems may be one you can solve yourself.

	PROBLEM	REMEDY
Power Supply	• Power won't go on:	• The power cord may not be plugged in. Plug it firmly into the outlet.
	• Although the power is on, the VCR won't work.	• There is no cassette in the VCR. Load a cassette.
Clock/Timer	<ul style="list-style-type: none"> • The clock will not work. • The timer will not work properly. 	<ul style="list-style-type: none"> • There has been a power failure. Reset the clock. • The clock time is incorrect. Adjust the clock to the correct time.
TV Reception	• Picture does not appear on the TV screen.	<ul style="list-style-type: none"> • The TV channel must be set to the VCR output Channel 3 or 4 or set the TV/VCR select switch on the TV to VCR. • The channel you want is not tuned correctly on the VCR. Adjust the tuning knob on your TV. • Adjust antenna direction or use an optional antenna booster. • The power cord must be plugged into the outlet firmly.
Recording and Playback	• Picture does not appear on the TV screen during recording and playback.	• Make sure the TV/VCR button is set to VCR and that the TV channel is set to 3 or 4.
	• TV VCR will not record.	• The cassette's safety tab may be broken. Use a cassette with tab or cover the hole with cellophane tape.
	• The picture on the VCR tape is poor.	<ul style="list-style-type: none"> • Adjust the TV fine tuning knob. • Adjust the tracking knob on the VCR. • Clean the video heads of the VCR with a commercial cleaning cassette tape.
	• The timer recording function will not work.	<ul style="list-style-type: none"> • There is an error in programming. Reprogram the preset information. • There must be a cassette in the VCR. • If the cassette does not have its safety tab, you must use another cassette or cover the hole with cellophane tape. • The timer indicator must be lit. Reprogram your recording information, making sure you press the TIMER button within nine seconds. • There has been a power failure. Reset the clock to the correct time if it is flashing 12:00 AM on the TV screen and reprogram the timer.
Remote Control	• The remote control will not work properly.	<ul style="list-style-type: none"> • Put new batteries in if the current batteries is low. • Make sure the remote control is within a 30° angle of the receptor on the VCR. • Use the remote control within 23 feet (7m) from the VCR. • Remove any obstacle between the VCR and the remote control.
Miscellaneous	• The cassette is ejected immediately after it is loaded.	• Remove the cassette and reload it carefully.
	• The cassette will not go into the cassette compartment.	<ul style="list-style-type: none"> • The cassette was loaded immediately after pressing EJECT. Reload the cassette, waiting a moment after ejecting another tape. • There is already a tape in the VCR.

LIMITED WARRANTY

TOSHIBA VIDEO CASSETTE RECORDER

Toshiba America Consumer Products, Inc. ("TACP") and Toshiba Hawaii Inc. ("THI") make the following limited warranties. These limited warranties extended to the original consumer purchaser or any person receiving this set as a gift from the original consumer purchaser and to no other purchaser or transferee.

Limited Ninety (90) Day Warranty

TACP and THI warrant this product against defects in materials or workmanship for a period of ninety (90) days after the date of original retail purchase. During this period, TACP and THI will repair a defective product or part, without charge to you. You must deliver the entire product to a TACP/THI Service Center. You pay for all transportation and insurance charges for the set to and from the Service Center.

Limited One (1) Year Warranty

TACP and THI further warrant the parts in this product against defects in materials or workmanship for a period of one year after the date of original retail purchase. During this period, TACP and THI will replace a defective part without charge to you, except that if a defective part is replaced after ninety (90) days from the date of the original retail purchase you pay labor charges involved in the replacement. You must also deliver the entire product to one of the TACP/THI Service Centers. You pay for all transportation and insurance charges for the set to and from the Service Center.

Owner's Manual and Registration Card

You should read the owner's manual thoroughly before operating this product. You should also insure that your name and address are on file as owners of a TACP/THI product by completing and mailing the enclosed registration card within ten days after you, or the person who has given you this product as a gift, purchased this product.

Step-By-Step Procedures - How to Obtain Warranty Service

IN THE CONTINENTAL UNITED STATES...

Should your unit require service or parts, CALL

This is one way to enable TACP/THI to establish the date of purchase of the product, as well as to provide you with better customer service and improved products. Failure to return the card will not affect your rights under this warranty so long as you retain other proof of purchase such as a bill of sale.

Your Responsibility

The above warranties are subject to the following conditions:

- (1) You must retain your bill of sale or provide other proof of purchase. Completing and mailing in the enclosed registration card within ten days after the original retail purchase is one way of providing such other proof of purchase.
- (2) You must notify an Authorized TACP/THI Service Station within thirty (30) days after you discover a defective product or part.
- (3) All warranty servicing of this product must be made by an Authorized TACP/THI Service Station.
- (4) These warranties are effective only if the product is purchased and operated in the U.S.A.
- (5) Labor service charges for set installation, set up, adjustment of customer controls and installation of repair or antenna systems are not covered by this warranty. Reception problems caused by inadequate antenna systems are your responsibility.
- (6) Warranties extend only to defects in materials or workmanship as limited above and do not extend to any product or parts which have been lost or discarded by you or to damage to products or parts caused by misuse, accident, improper installation, improper maintenance or use in violation of instructions furnished by us; or to units which have been altered or modified without authorization of TACP/THI or to damage to products or parts there of which have had the serial number removed, altered, defaced or rendered illegible.



HAWAII

Toshiba Hawaii Inc.
Service Department
327 Kamakee Street
Honolulu, HI 96814
Phone Number:
(808) 521-5377

IN THE EVENT A PROBLEM SHOULD DEVELOP WITH YOUR PRODUCT, PLEASE PROCEED AS FOLLOWS:

- (1) Refer to the troubleshooting guide in your owner's manual. This check list may solve your problem.
- (2) Contact one of the TACP/THI Service Centers listed below for warranty service or call the TACP toll free number 1-800-631-3811 within thirty (30) days after you find a defective product or part.
- (3) Arrange for the delivery of the product to the Authorized TACP/THI Service Center. Products shipped to the Service Center must be insured and safely and securely

packed, preferably in the original shipping carton, and a letter explaining the defect and also a copy of the bill of sale or other proof of purchase must be enclosed. All transportation and insurance charges must be prepaid by you. (See Packing and Shipping instructions on TOSHIBA SERVICE PROCEDURE).

- (4) If you have any question about service, please contact one of the following TACP/THI Service Centers:

EAST

82 Totowa Road
Wayne, NJ 07470
Phone Number:
(201) 628-8000

SOUTHEAST

490 Armour Circle, N.E.
Atlanta, GA 30324
Phone Number:
(404) 872-6955

MIDWEST

1010 Johnson Drive
Buffalo Grove, IL
60089
Phone Number:
(312) 541-9400

SOUTHWEST

1421 champion Drive
Suite 304
Carrollton, TX 75006
Phone Number:
(214) 243-1367

WEST

19500 South
Vermont Ave.
Torrance, CA 90502
Phone Number
(213) 770-3300

IMPORTANT: PACKING AND SHIPPING INSTRUCTIONS

When you send the product to a service center, you must use the original carton box and packing material, then insert the original carton box containing the unit into another carton, using more packing material.

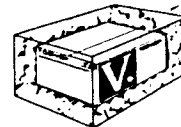

ALL WARRANTIES IMPLIED BY STATE LAW, INCLUDING THE IMPLIED WARRANTIES OF MERCHANTABILITY AND FITNESS FOR A PARTICULAR PURPOSE, ARE EXPRESSLY LIMITED TO THE DURATION OF THE LIMITED WARRANTIES SET FORTH ABOVE. Some states do not allow limitations on how long an implied warranty lasts, so the above limitation may not apply to you. **WITH THE EXCEPTION OF ANY WARRANTIES IMPLIED BY STATE LAW AS HEREBY LIMITED, THE FOREGOING EXPRESS WARRANTY IS EXCLUSIVE AND IN LIEU OF ALL OTHER WARRANTIES, GUARANTEES, AGREEMENTS AND SIMILAR OBLIGATIONS OF MANUFACTURER OR SELLER WITH RESPECT TO THE REPAIR OR REPLACEMENT OF ANY PRODUCT OR PARTS.**

IN THE EVENT SHALL TACP OR THI BE LIABLE FOR CONSEQUENTIAL OR INCIDENTAL DAMAGES. Some states do not allow the exclusion or limitation of incidental or consequential damages so the above limitation may not apply to you.

No person, agent, distributor, dealer, service station or company is authorized to change, modify or extend the terms of these warranties in any manner whatsoever. The time within which an action must be commenced to enforce any obligation of TACP and THI arising under this warranty or under any statute, or law of the United States or any state thereof, is hereby limited to one year from the date you discover or should have discovered, the defect. This limitation does not apply to implied warranties arising under state law. Some states do not permit limitation of the time within which you may bring an action beyond the limits provided by state law so the above provision may not apply to you. This warranty gives you specific legal rights and you may also have other rights which vary from state to state.

TOSHIBA AMERICA CONSUMER PRODUCTS, INC.

Printed in Korea

BZ634177



TOSHIBA
... In Touch with Tomorrow