

TOSHIBA

VHS

Video Cassette Recorder

M-250
M-444

OWNER'S MANUAL



INTRODUCTION 3

PREPARATION 19

CONVENIENT
FUNCTION 31

SPECIALIZED
EFFECTS 32

TIMER
FUNCTION 34

SPECIALIZED
OPERATIONS 39

OTHERS 40

Welcome to the high quality picture world created by the TOSHIBA M-250 and M-444. Read this manual carefully before use and enjoy the various convenient functions of this VCR.

PLEASE READ

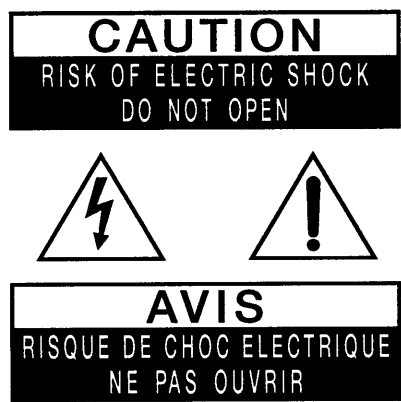

The lightning flash with arrowhead symbol, within an equilateral triangle, is intended to alert the user to the presence of uninsulated "dangerous voltage" within the product's enclosure that may be of sufficient magnitude to constitute a risk of electric shock to persons.

The exclamation point within an equilateral triangle is intended to alert the user to the presence of important operating and maintenance (servicing) instructions in the literature accompanying the appliance.

WARNING: TO REDUCE THE RISK OF FIRE OR ELECTRIC SHOCK, DO NOT EXPOSE THIS APPLIANCE TO RAIN OR MOISTURE. DANGEROUS HIGH VOLTAGES ARE PRESENT INSIDE THE ENCLOSURE. DO NOT OPEN THE CABINET. REFER SERVICING TO QUALIFIED PERSONNEL ONLY.

The VCR is not disconnected from the AC power source as long as it is connected to the wall outlet, even if the VCR itself has been turned off.

USER-INSTALLER CAUTION: YOUR AUTHORITY TO OPERATE THIS FCC CERTIFIED EQUIPMENT COULD BE VOIDED IF YOU MAKE CHANGES OR MODIFICATIONS NOT EXPRESSLY APPROVED BY THIS PARTY RESPONSIBLE FOR COMPLIANCE TO PART 15 OF THE FCC RULES.

Note to CATV system installer:

This reminder is provided to call the CATV system installer's attention to Article 820-40 of the NEC that provides guidelines for proper grounding and, in particular, specifies that the cable ground shall be connected to the grounding system of the building, as close to the point of cable entry as practical.

Copyright

It is permissible to record television programs, film video tapes and other material only in the event that third party copyrights and other rights are not violated.

This equipment has been tested and found to comply with the limits for a TV Interface device, pursuant to Part 15 of the FCC Rules. These limits are designed to provide reasonable protection against harmful interference in a residential installation. This equipment generates, uses, and can radiate radio frequency energy and, if not installed and used in accordance with the instructions, may cause harmful interference to radio communications. However, there is no guarantee that interference will not occur in a particular installation. If this equipment does cause harmful interference to radio or television reception, which can be determined by turning the equipment off and on, the user is encouraged to try to correct the interference by one or more of the following measures:

- Reorient or relocate the receiving antenna.
- Increase the separation between the equipment and receiver.
- Connect the equipment into an outlet on a circuit different from that to which the receiver is connected.
- Consult the dealer or an experienced radio/TV technician for help.

NOTE: Any changes or modifications not expressly approved by the manufacturer in accordance with the regulations may void the user's right to use the equipment.

In the spaces provided below, record the Model and Serial No. located at the rear of your video cassette recorder.

Model No. _____ Serial No. _____

Retain this information for future reference.

Accessories

Check to make sure that you have all of the following accessories before disposing of the packing materials.

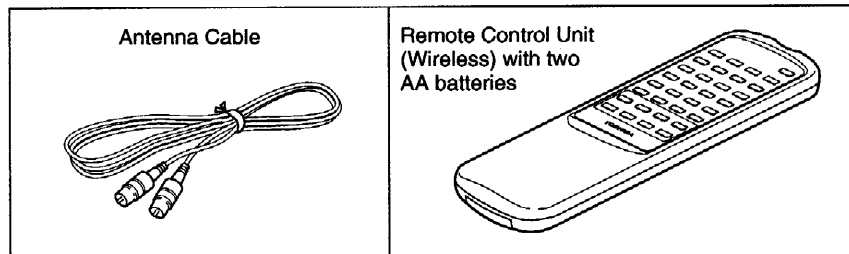

INTRODUCTION

Important Precautions

Save Original Packing Materials

The original shipping carton and packing materials will come in handy if you ever have to ship your VCR. For maximum protection repack the set as it was originally packed at the factory.

Moisture Condensation

Never operate this unit immediately after moving it from a cold location to a warm location. When the VCR is exposed to such a change in temperature, moisture may condense on the cylinder inside the machine. If the VCR is operated as it is, the tape may stick to the tape head and cause damage to the tape and/or the deck. Under these circumstances, do not operate the VCR for about 2 hours. Leave the power cord connected so that the VCR can dry out.

Compatibility

This video cassette recorder (VCR) is compatible with any other VCR bearing the VHS logo. HQ VHS equipment is also compatible with existing non-HQ VHS equipment.

Table of Contents

INTRODUCTION

INTRODUCTION	3
Important Precautions	3
Important Safeguards	4
Features	7
INSTALLATION	8
TV Antenna and VCR Connections	8
VCR and TV Connections	9
CATV Connections	10
CONTROLS	14
Front Panel	14
Rear Panel	14
Multi-display	15
Remote Control Unit	16
Using the Remote Control Operation	17
Use of the Video Cassette	17
Setting the VCR Output Channel	18
Using the TV/VCR Button on the Remote Control Unit	18

PREPARATION

PREPARATION	19
Presetting the Language	19
Using the Menu	19
Setting the VCR Clock	21
Operating the FS Tuner	22
Channel Memory	24
On Screen Display (OSD)	26

BASIC OPERATION

PLAYBACK	27
Basic Playback	27
RECORDING	29
Basic Manual Recording	29
One-Touch Timer Recording	30

CONVENIENT FUNCTION

COUNTER FUNCTION	31
Counter Display	31

SPECIALIZED EFFECTS

SPECIALIZED EFFECTS	32
Picture Search	32
Still Frame	32
Slow Playback	33

TIMER RECORDING

PROGRAMABLE TIMER RECORDING	34
--	----

SPECIALIZED OPERATIONS

COPYING	39
Copying VCR Recording	39

OTHERS

OTHERS	40
Before Calling Service Personnel	40
Specifications	41

IMPORTANT SAFEGUARDS

CAUTION: PLEASE READ AND OBSERVE ALL WARNINGS AND INSTRUCTIONS GIVEN IN THE OWNER'S MANUAL FOR THIS UNIT AND THOSE MARKED ON THE UNIT. RETAIN THIS BOOKLET FOR FUTURE REFERENCE.

This set has been designed and manufactured to assure personal safety. However, improper use can result in electric shock or fire hazard. The safeguards incorporated in this unit will protect you if you observe the following procedures for installation, use and servicing. This unit is fully transistorized and does not contain any parts that can be repaired by the user.

DO NOT REMOVE THE CABINET COVER, OR YOU MAY BE EXPOSED TO DANGEROUS VOLTAGES. REFER SERVICING TO QUALIFIED SERVICE PERSONNEL.



1. After unpacking this video product, read the owner's manual carefully, and follow all the operating and other instructions.

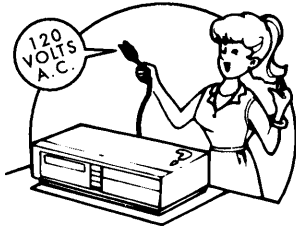

2. This video product should be operated only from the type of power source indicated on the marking labels. If you are not sure of the type of power supply to your home, consult your sales person or your local power company. For video products intended to operate from battery power or other sources, refer to the operating instructions.

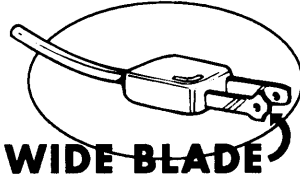

3. This video product is equipped with a polarized alternating current line plug (a plug having one blade wider than the other). This plug will fit into the power outlet only one way. This is a safety feature. If you are unable to insert the plug fully into the outlet, try reversing the plug. If the plug should still fail to fit, contact your electrician to replace your obsolete outlet. Do not defeat the safety purpose of the polarized plug.



4. Slots and vents in the cabinet are provided for ventilation and to ensure reliable operation of the video product and to protect it from overheating. These vents must not be blocked or covered. The vents should never be blocked by placing the video product on a bed, sofa, rug or other similar surface. This video product should never be placed near or over a radiator or heat register. This video product should not be placed in a built-in installation such as a bookcase or rack unless proper ventilation is provided or the manufacturer's instructions have been adhered to.

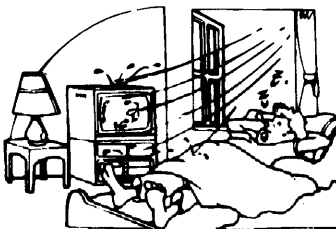

5. Do not expose this video product to rain or use near water. For example: near a bath tub, wash bowl, kitchen sink, or laundry tub, in a wet basement, or near a swimming pool and the like.



6. Unplug the video product from wall outlet before cleaning. Use only a soft damp cloth and never use benzine, thinner or other solvents for cleaning.

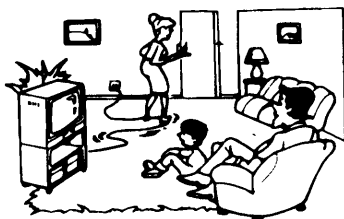

- 7. Do not allow anything to rest on the power cord. Do not locate this video product where the cord will be walked on.

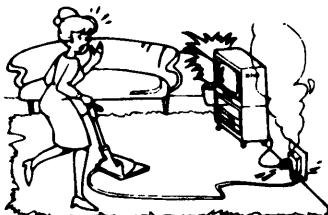

- 8. Do not overload wall outlets and extension cords as this can result in fire or electric shock.

- 9. If an outside antenna or cable system is connected to the video product, be sure the antenna or cable system is grounded so as to provide some protection against voltage surges and built-up static charges. Section 810 of the National Electrical Code, ANSI/NFPA No.70, provides information with regard to proper grounding of the mast and supporting structure, grounding of the lead-in wire to an antenna discharge unit, size of grounding conductors, location of antenna-discharge unit, connection to grounding electrodes, and requirements for the grounding electrode.

**EXAMPLE OF ANTENNA
GROUNDING AS PER
NATIONAL ELECTRICAL CODE**

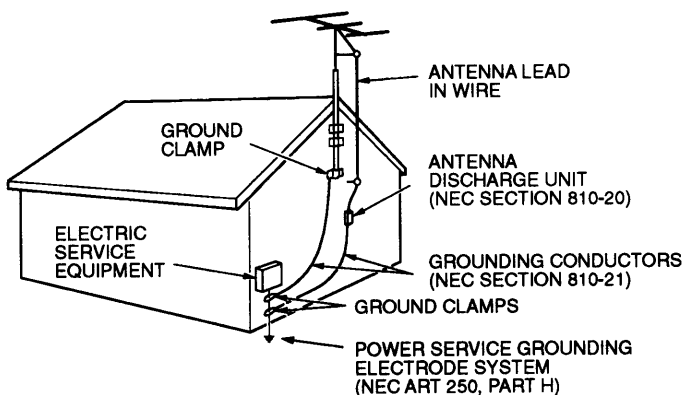

S2898A

NEC - NATIONAL ELECTRICAL CODE

- 10. An outside antenna system should not be located in the vicinity of overhead power lines or other electric light or power circuits, or where it can fall into such power lines or circuits. When installing an outside antenna system, extreme care should be taken to keep from touching such power lines or circuits as contact with them might be fatal.

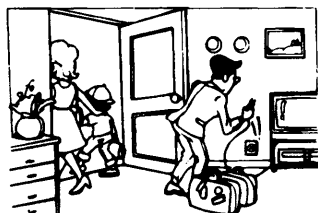

- 11. For added protection for this video product receiver during a lightning storm, or when it is left unattended and unused for long periods of time, unplug it from the wall outlet and disconnect the antenna or cable system. This will prevent damage to the video product due to lightning and power-line surges.



- 12. An appliance and cart combination should be moved with care. Quick stops, excessive force, and uneven surfaces may cause the appliance and cart combination to overturn.

13. Never push objects of any kind into this video product through openings as they may touch dangerous voltage points or short-out parts that could result in a fire or electric shock. Never spill liquid of any kind on the video product.
14. Do not use attachments not recommended by the video product manufacturer as they may cause hazards.
15. Do not place this video product on an unstable cart, stand, tripod, bracket, or table. The video product may fall, causing serious injury to a child or adult and serious damage to the appliance. Use only with a cart, stand, tripod, bracket, or table recommended by the manufacturer, or sold with the video product.



16. Unplug this video product from the wall outlet and refer servicing to qualified service personnel under the following conditions:
 - A. When the power-supply cord is damaged.
 - B. If liquid has been spilled or objects have fallen into the video product.
 - C. If the video product has been exposed to rain or water.
 - D. If the video product does not operate normally by following the operating instructions. Adjust only those controls that are covered by the operating instructions. An improper adjustment of other controls may result in damage and will often require extensive work by a qualified technician to restore the video product to its normal operation.
 - E. If the video product has been dropped or the cabinet has been damaged.
 - F. When the video product exhibits a distinct change in performance.

Do not attempt to service this video product yourself as opening or removing covers may expose you to dangerous voltage or other hazards. Refer all servicing to qualified service personnel.

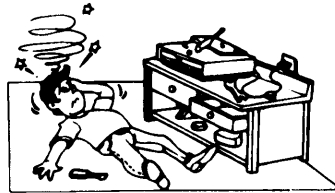

17. Upon completion of any service or repairs, request the service technician's assurance that only Factory Authorized Replacement Parts that have the same characteristics as the original parts were used, and that routine safety checks have been performed to determine that the video product is in safe operating condition. Unauthorized parts may result in fire, electrical shock, or other hazards.

Features

1. Convenient Functions

1) Counter Function

The tape counter displays the amount of recorded tape. By setting the counter, you can return to any point on the tape easily.

2) Multilingual On-Screen Display

- With the on-screen display, the current VCR function mode or the currently selected TV or CATV channel can be easily confirmed. The settings for timer recording can also be confirmed with the on-screen display.
- The On-Screen Display can be set to use English, French or Spanish.

3) Programmable Timer Recording

4 programs can be set to be recorded up to 1 month in advance.

4) Digital Auto Tracking

The tracking of the playback picture is automatically adjusted for the best possible picture.

5) Auto Playback

When a tape without a safety tab is loaded, the following operations start automatically.

- **Full Auto Playback:** If a cassette without a safety tab is loaded while the VCR is turned off, the VCR will automatically turn on and the tape will play back. At the end of the tape, it will automatically rewind to the beginning and the cassette will eject. Then the VCR will automatically turn off.
- **Auto Playback:** This operation automatically plays back the tape when a cassette without a safety tab is inserted with the VCR power on. When the tape reaches the end, it will automatically rewind to the beginning and stop.
- **Auto Rewind:** This operation automatically rewinds the tape when the tape reaches the end.

6) Auto Power On

When a tape is loaded with the VCR power off, power will automatically turn on.

7) Auto Channel Memory

Automatically stores all the channels that can be received in your area.

2. Special Functions

- **Picture Search:** Scans programs while fast forwarding or rewinding the tape, enabling you to watch the picture during these operations.
- **Still Frame:** Freezes the picture temporarily while playing back the tape.
- Slow playback is possible at 2 speeds, 1/6 and 1/18 of normal playback speed.

3. Others

- **181 Channel Receivable FS (Frequency Synthesized) Tuner:** This FS tuner automatically selects all receivable channels such as those for UHF, VHF and CATV.
- **Multi-Function Fluorescent Indicator Panel**
- **Infrared Remote Control Unit:** The VCR can be operated with the supplied wireless remote control unit for up to a distance of about 23 feet (7 meters).
- **Auto Head Cleaner:** This VCR is equipped with an Automatic Video Head Cleaner. This feature will ensure that your VCR always performs at its best by keeping the video heads clean of dirt that can distort picture quality. The Auto Head Cleaner engages automatically each time a tape is inserted or ejected.

INSTALLATION

TV Antenna and VCR Connections

To connect the VCR to a VHF or UHF antenna (Fig. 1), follow the steps below.
 Remove the VHF and/or UHF cables from your TV terminals and reconnect them to the VCR terminals as shown in the diagrams below.

Note

For VHF or UHF connections follow procedure ①, if you have a 75 ohm coaxial cable. Follow procedure ② if you have a 300 ohm twin lead connector (i.e. use an optional 300 - 75 ohm transformer).

Fig. 1 VHF or UHF Reception Areas

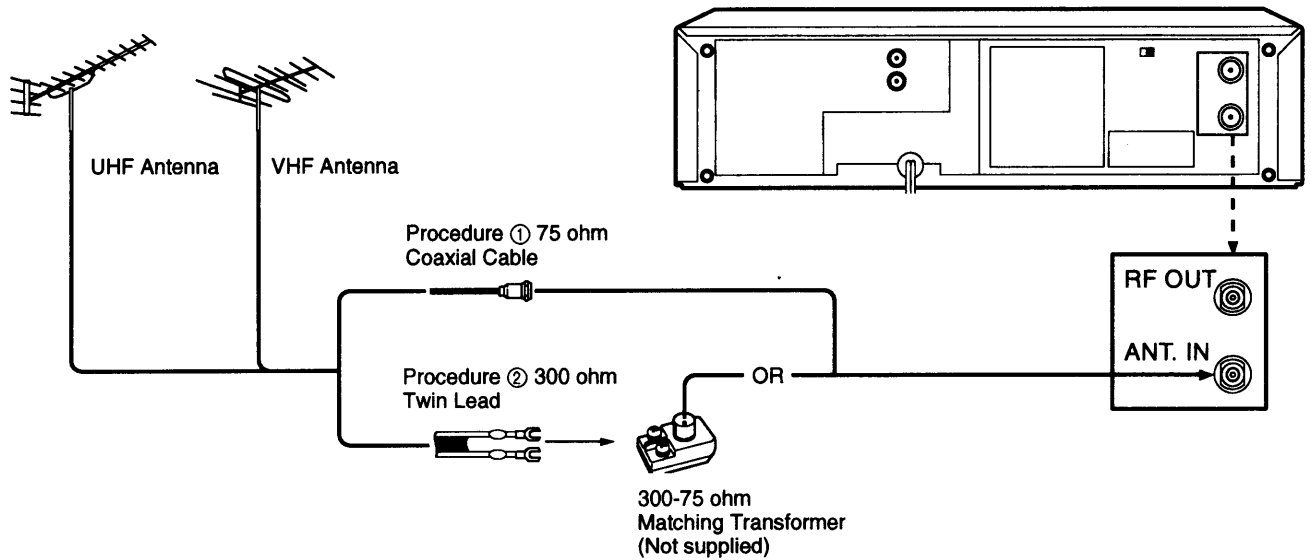
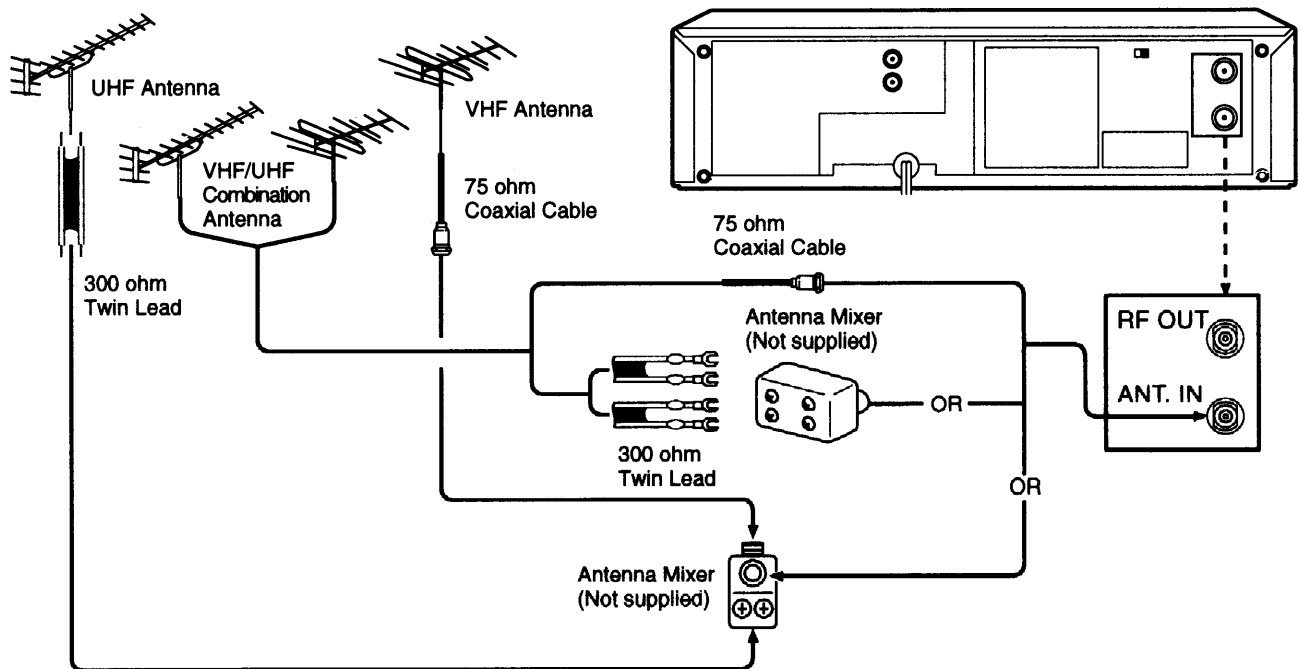

Fig. 2 Combined VHF/UHF Reception Areas



VCR and TV Connections

Connection to TV Antenna Terminals

Fig. 1 VHF (75 ohm/300 ohm) or VHF (75 ohm) Terminal Connection

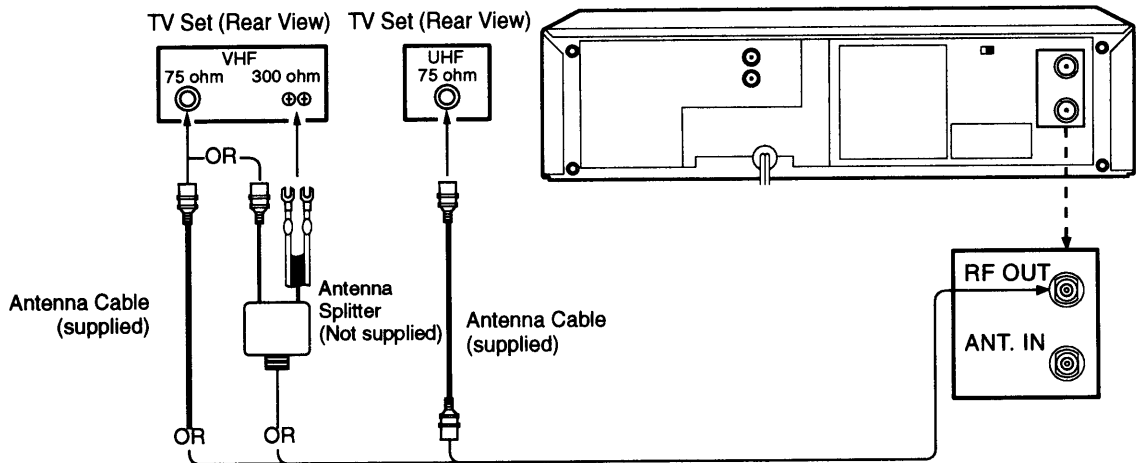
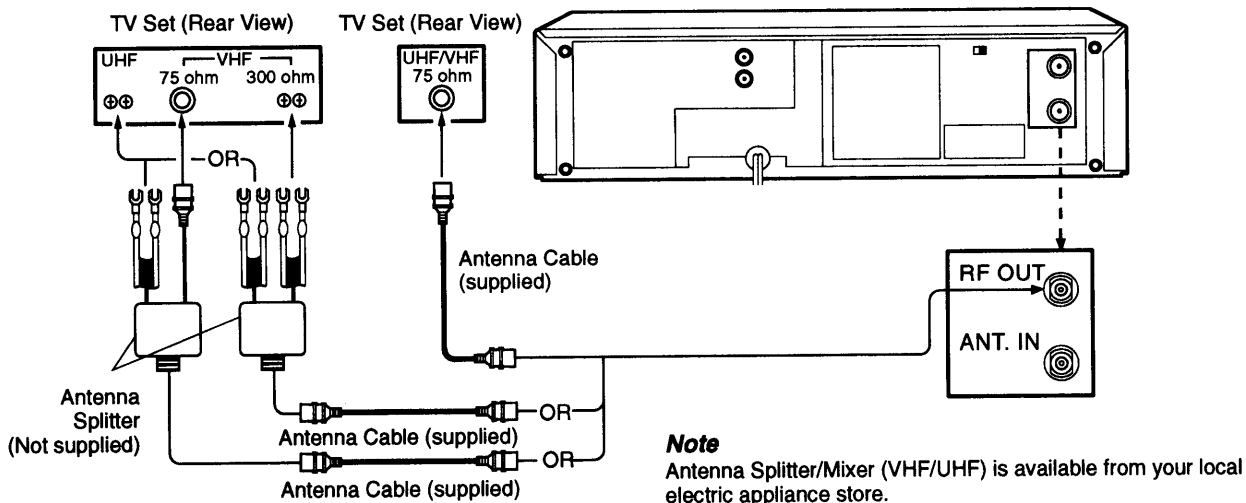
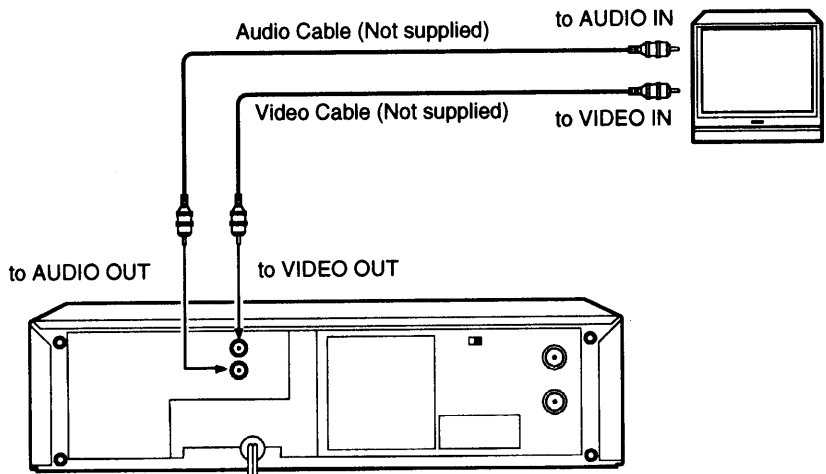

Fig. 2 VHF/UHF (75 ohm/300 ohm or 300 ohm/300 ohm) or VHF/UHF (75 ohm) Terminal Connection



Connection to TV with "VIDEO IN" and "AUDIO IN" Connections



CATV Connections

There are several different systems of cable television used today. We recommend that you consult your cable TV company to make sure that the cable is connected properly to match the cable TV system you want to use.

To Record and Watch Unscrambled Channels

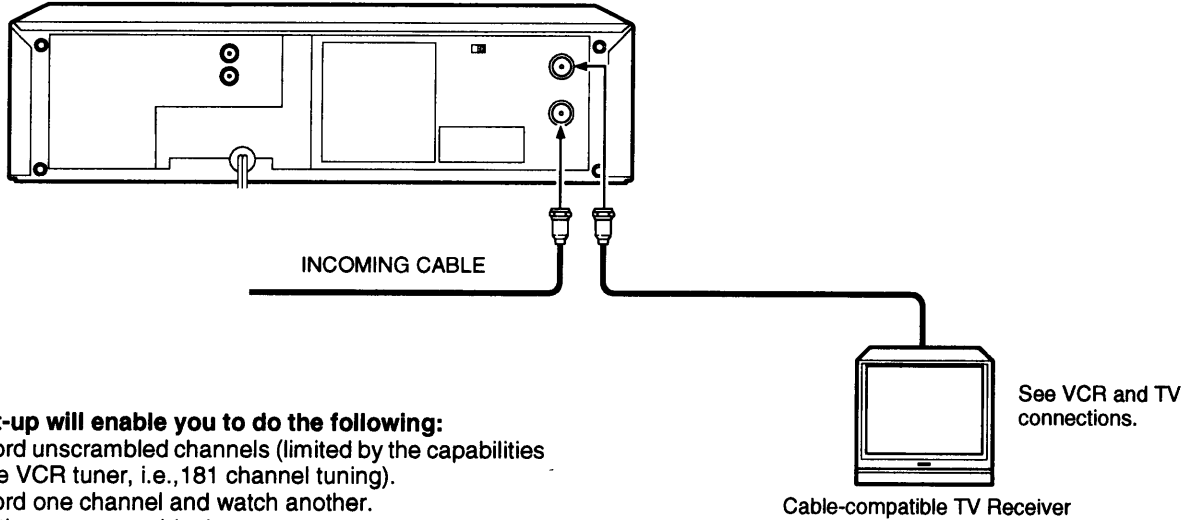

This set-up will enable you to do the following:

- Record unscrambled channels (limited by the capabilities of the VCR tuner, i.e., 181 channel tuning).
- Record one channel and watch another.
- Use the programmable timer.

To Record an Unscrambled Channel and Watch Another Channel (Scrambled or Unscrambled)

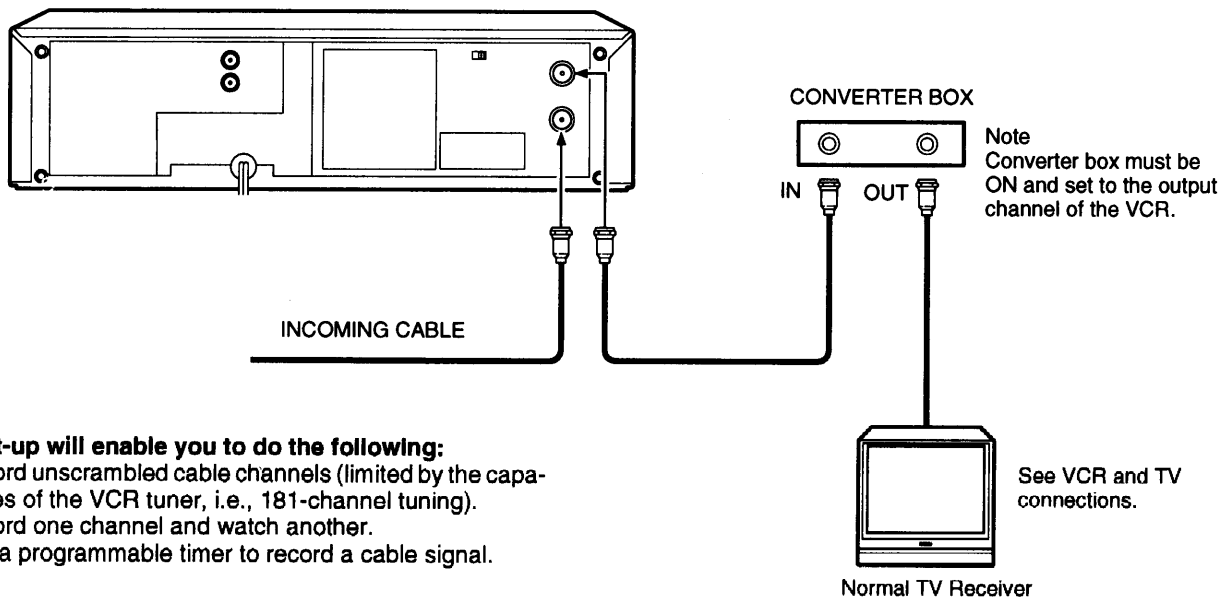

This set-up will enable you to do the following:

- Record unscrambled cable channels (limited by the capabilities of the VCR tuner, i.e., 181-channel tuning).
- Record one channel and watch another.
- Use a programmable timer to record a cable signal.

Notes

- This set-up will not allow you to record scrambled channels.
- When in playback or when using the VCR tuner ("VCR" is selected with the **TV/VCR** button on the remote control unit), the converter box must be set to channel 3 or 4.
- When the TV position is selected with the **TV/VCR** button, the converter box can tune into any available channel.

To Record and Watch the Same Channel (Unscrambled/Scrambled)

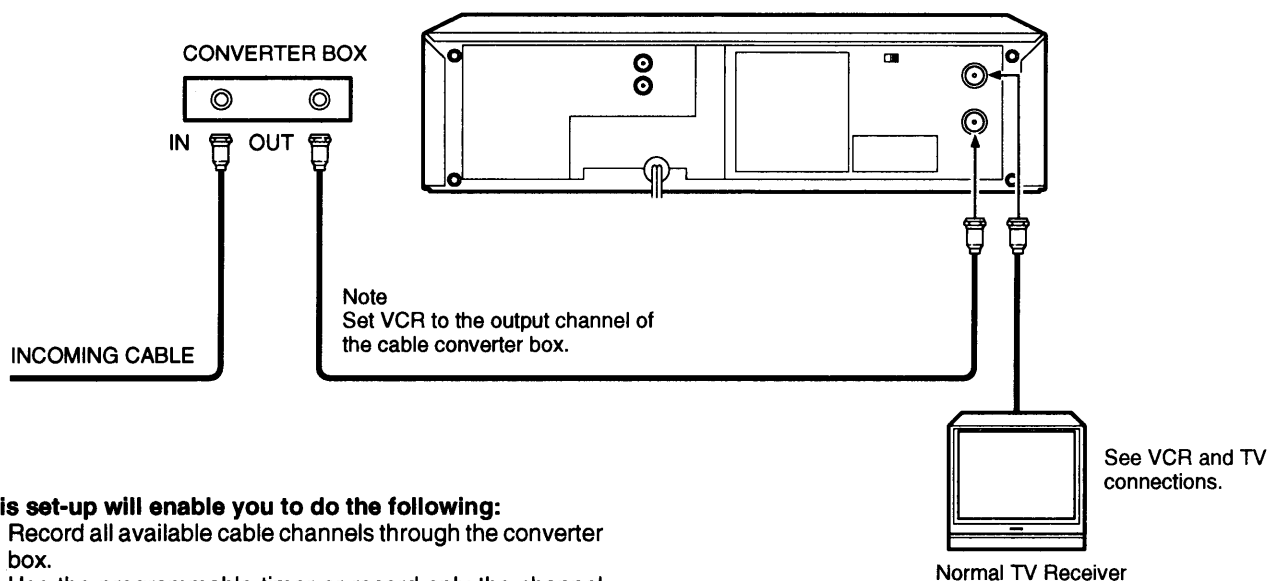

This set-up will enable you to do the following:

- Record all available cable channels through the converter box.
- Use the programmable timer or record only the channel selected at the converter box.

Note

This set-up will not allow you to record one channel and watch another.

To Record an Unscrambled Channel and Watch Only Unscrambled or Scrambled Channels

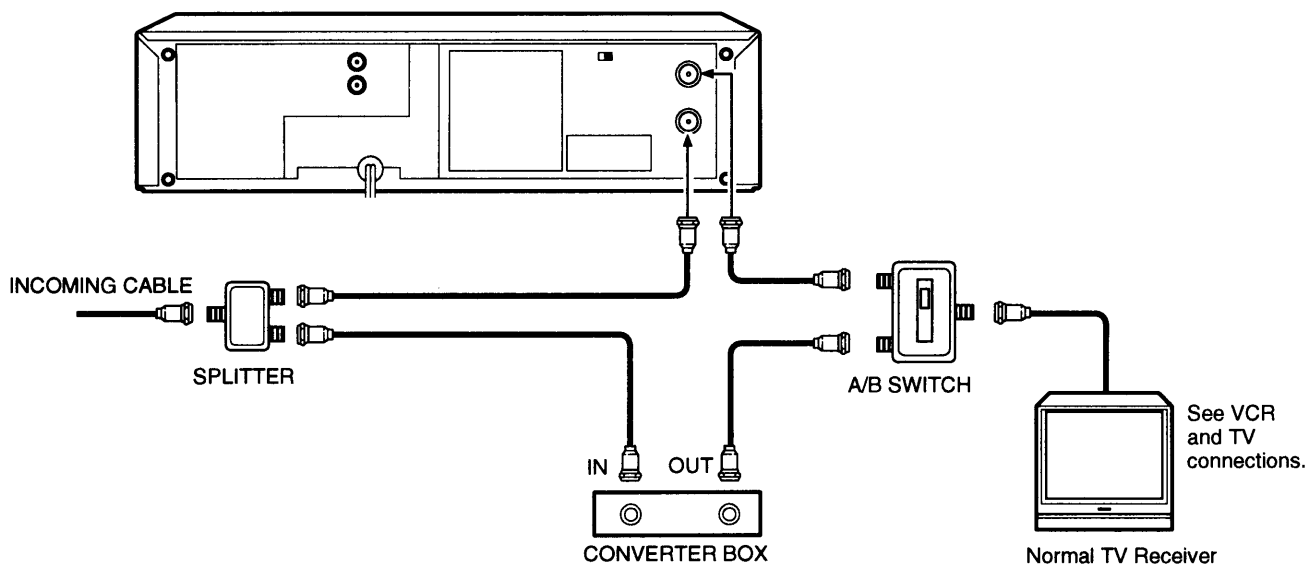

This set-up will enable you to do the following:

- Record an unscrambled cable channel.
- Monitor all cable channels from converter box when A/B switch is in "B" position.
- Watch one channel and record another.
- Use VCR remote control when A/B switch is in "A" position.
- Use programmable timer to record cable signal.

Notes

- This set-up will not allow you to record scrambled channels.
- Select the channel to watch on the converter.
- Set the TV channel selector to the output of the converter and VCR.

To Record and Watch the Same Channel (Scrambled or Unscrambled)

To Record one Unscrambled Channel and Watch Another Unscrambled Channel

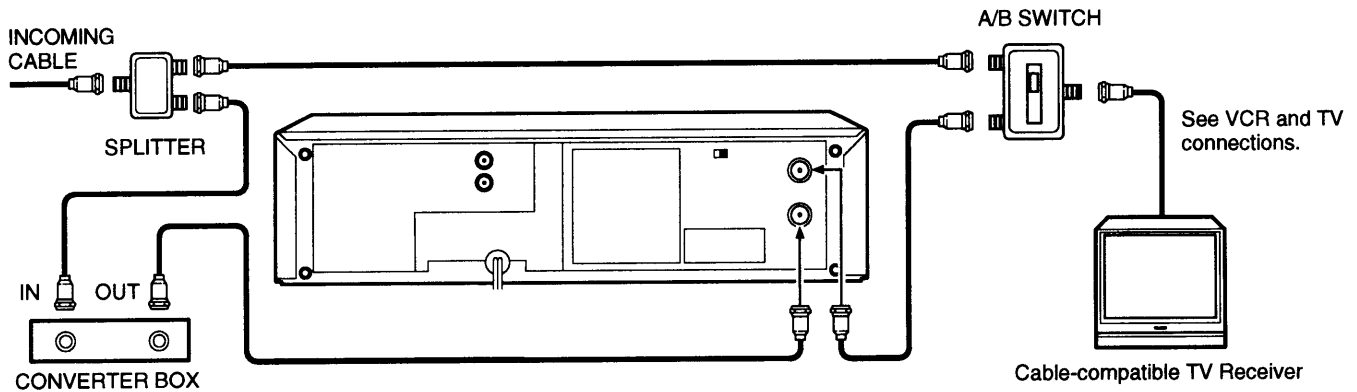

This set-up will enable you to do the following:

- Record all cable channels from the converter box.
- Record one scrambled channel and watch another unscrambled channel.
- Use the TV remote control when the A/B switch is in the "A" position.
- Use the programmable timer to record only the channel selected on the converter box. (Converter box power must be ON.)

Notes

- Set the VCR channel selector to the output channel of the converter.
- Select the channel to be recorded on the converter.
- Set the TV channel selector to the output channel or VCR (3 or 4).

To Record and Watch a Scrambled or Unscrambled Channel

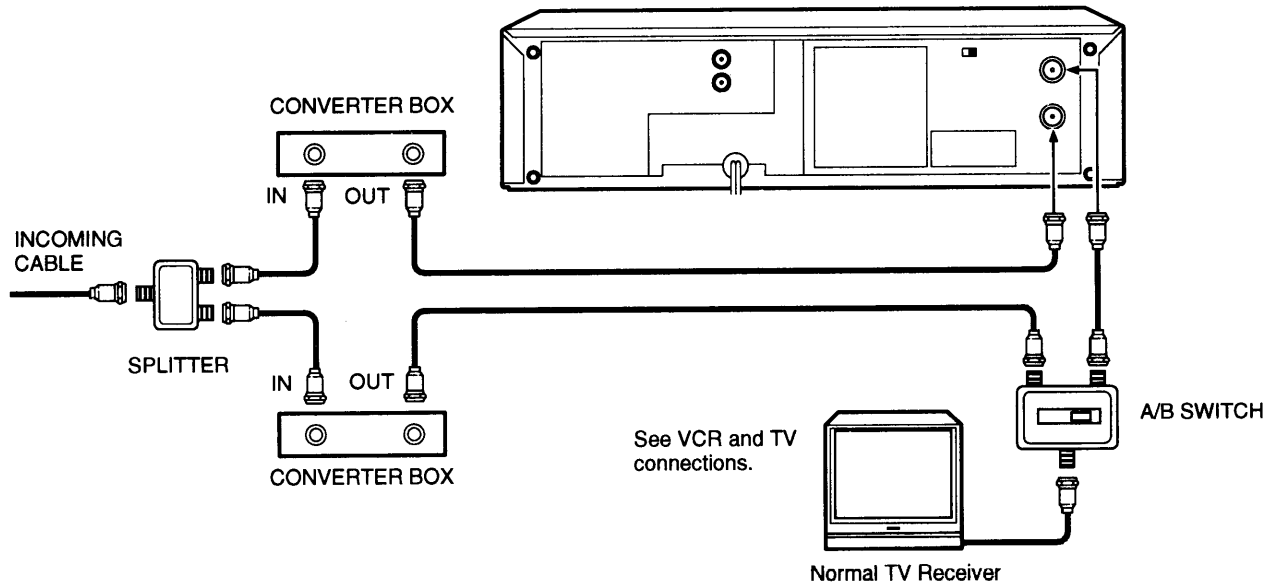

This set-up will enable you to do the following:

- Record any cable channel.
- Record one channel and watch another.
- Use programmable timer to record only the channel selected at the converter box.

Notes

- Set the TV channel selector to the output channel of the VCR and the converter box (3 or 4).
- Set the VCR channel selector to the output channel of converter box.

To Record and Watch the Same Channel (Scrambled/Unscrambled)

To Record One Unscrambled Channel and Watch Another Unscrambled Channel

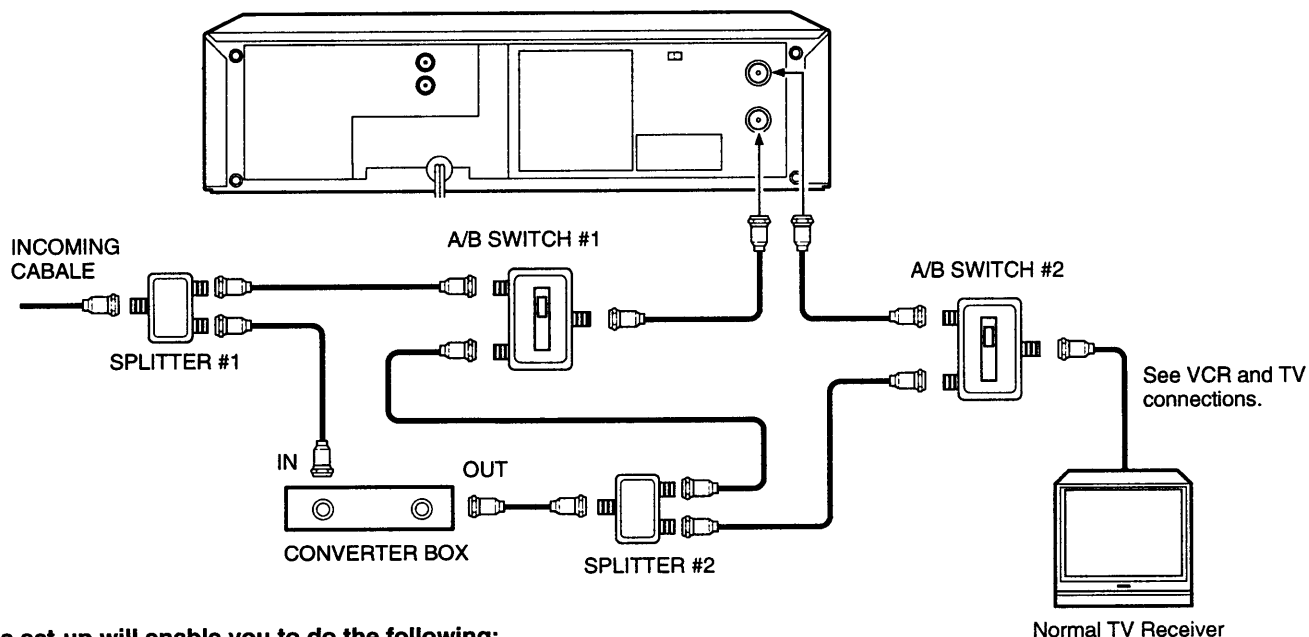

This set-up will enable you to do the following:

- Record an unscrambled cable channel (A/B switch # 1 in "A" position).
- Record all cable channels from the converter box (through splitter #2 and A/B switch #1 "B" position).
- Record one channel while watching another.
- Use the programmable timer when A/B switch #1 is in the "A" position.

Notes:

"Unscrambled" Cable Channels

Cable companies usually include "Unscrambled" channels in their basic subscription service. Depending on the tuning capability of your TV (how many cable channels your TV is capable of tuning to) you may not need a cable converter box (supplied by the cable company) to view "unscrambled" cable channels on your TV set.

"Scrambled" Channels

Extra (optional) pay cable channels, like HBO and Cinemax in some localities, are often "scrambled" by the cable company. To view these channels on your TV, you must use the cable converter (decoder) box supplied by the cable company.

Cable Converter Box (supplied by Cable Company)

Until recently, all television and VCR receivers were equipped with 68 channel tuners capable of tuning the 12 standard VHF channels (2-13) and the 56 UHF channels (14-69). Since cable television systems do not use the UHF band, once they began expanding beyond 12 channel capacity (some cable companies transmit up to 100 channels) some form of converter became necessary to enable their subscribers to tune in the additional channels. This "cable converter box" rebroadcasts the programs to your TV set or VCR on one designated channel, usually channel 2, 3, or 4. When you use a converter box, you will normally change channels using the channel selector on the box. Some cable converters have built-in decoders that translate "scrambled" pay TV channels (i.e. HBO) so they can be used by your TV set.

Notes:

- Set the VCR and TV channel selector to the output of the converter.
- Select the channel to record at the converter.

Frequency Conversion

This simply means the ability to change one frequency to another (e.g. when Channel 7 is selected, the converter box takes the Channel 7 information and outputs this on Channel 3 frequency; when Channel 11 is selected, the converter box takes the Channel 11 information and outputs this on Channel 3 frequency.) The converter box and the VCR use this principle of frequency conversion.

CONTROLS

Front Panel

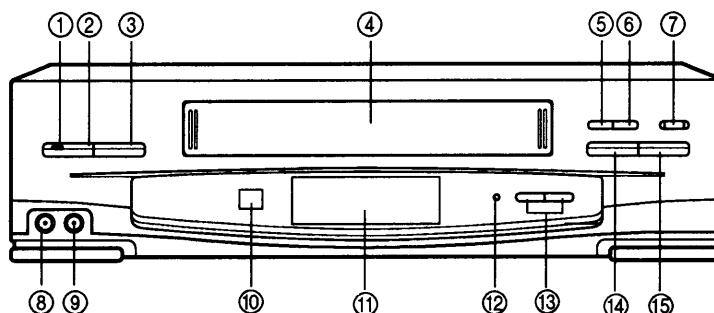

- ① **POWER INDICATOR**
Lights up when the POWER button is pressed.
- ② **POWER button**
Press to turn the VCR on and off.
- ③ **EJECT button**
Press to eject the cassette.
- ④ **CASSETTE LOADING SLOT**
- ⑤ **REW button**
In stop mode, press to rewind the tape. In play mode, press to visually search a desired portion of the video tape in the reverse direction. If the REW button is held down for more than 1 second, search speed will be faster until the button is released.
- ⑥ **FF button**
In stop mode, press to fast forward the tape. In play mode, press to visually search a desired portion of the video tape in the forward direction. If the FF button is held down for more than 1 second, search speed will be faster until the button is released.
- ⑦ **REC button (REC/OTR)**
Press to start recording. Repeatedly press to select a desired duration for the one-touch timer recording.
- ⑧ **VIDEO IN jack**
To record from an external video source, such as a VCP, VCR or TV set, connect this jack to the VIDEO output jack of one of those sources.
- ⑨ **AUDIO IN jack**
Connect to the audio output from another video recorder or other audio sources for recording.
- ⑩ **REMOTE SENSOR**
This receives the infrared beam transmitted from the remote control unit. See the section titled "REMOTE CONTROL UNIT" for details.
- ⑪ **DISPLAY PANEL**
- ⑫ **RESET button**
Clears all the user-programmed data and restores the factory-preset initial values.
- ⑬ **CHANNEL Δ /V buttons**
Press to step up/down the TV channels for TV viewing. During playback, these buttons are also used to perform manual tracking adjustment.
- ⑭ **PLAY button**
Press to start playback of a pre-recorded tape.
- ⑮ **STOP button**
Press to stop all the tape related functions.

Rear Panel

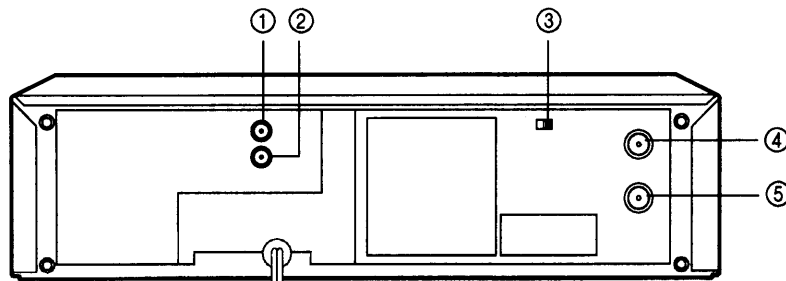

- ① **VIDEO OUT JACK**
For external recording or monitoring, connect this jack to the VIDEO input of a VCR or TV set.
- ② **AUDIO OUT JACK**
Audio signals being recorded or played back are available at this connector. Connect to the audio input of a TV receiver, another video recorder or other audio/video equipment.
- ③ **3-4 OUTPUT CHANNEL SELECTOR**
In order that signals received by the VCR can be converted into signals suitable for your TV set, move this switch to either 3CH or 4CH, whichever channel is unused in your area.
- ④ **RF OUT TERMINAL**
Connect this terminal to the TV set's VHF IN terminal or VHF/UHF IN terminal.
- ⑤ **ANTENNA IN TERMINAL**
For VHF reception, UHF reception or cable TV reception, connect this terminal to a VHF antenna, a UHF antenna or cable TV terminal.

Multi-display

- ① **VIDEO MODE INDICATOR [VCR]**
Lights up when the Video mode is selected by the TV/VCR switch.
- ② **CASSETTE LOADING INDICATOR []**
Illuminates when a cassette tape is loaded in the cassette slot.
- ③ **TIMER SET INDICATOR [TIMER]**
Lights up when the timer recording is ready.
- ④ **RECORDING INDICATOR [REC]**
Lights up when recording on a tape.
- ⑤ **AM/PM INDICATOR [AM/PM]**
Indicates AM or PM for clock/timer display.
- ⑥ **OPERATION MODE DISPLAY [-----]**
Indicates each operation mode.
- ⑦ **TV/CATV MODE INDICATOR [TV/CATV]**
Indicates the reception mode of broadcast TV or cable cast TV.
- ⑧ **CHANNEL INDICATOR [CH]**
Indicates the channel number.
- ⑨ **TAPE SPEED INDICATOR [SP/LP/SLP]**
Lights up to indicate the tape speed for recording/playback.
- ⑩ **DIGITAL TRACKING INDICATOR [DT]**
Blinks when digital tracking is activated. Stops blinking after the tracking is set.
- ⑪ **CLOCK/COUNTER DISPLAY**
Functions as a Clock or Real Time Tape Counter according to the mode selected.
- ⑫ **HOURLY/MINUTE/SECOND INDICATOR**
- ⑬ **TV CHANNEL INDICATOR**
Indicates the TV channel selected using the built-in TV tuner of the VCR.

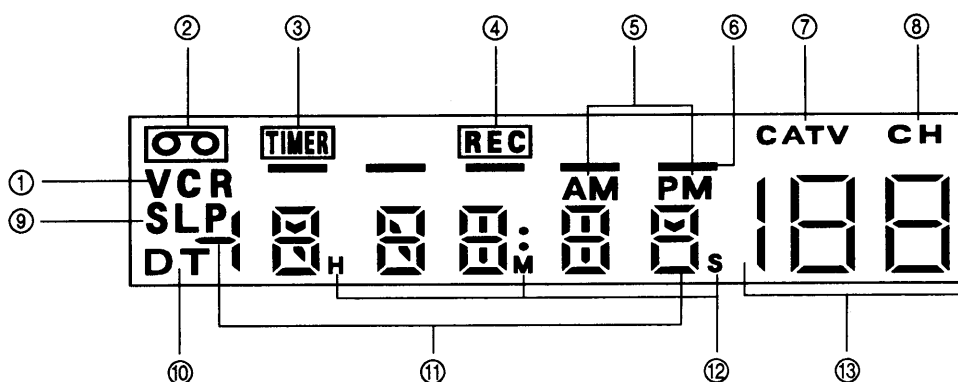

Remote Control Unit

The buttons that are not followed by explanations have the same functions as the buttons similarly marked on the VCR.

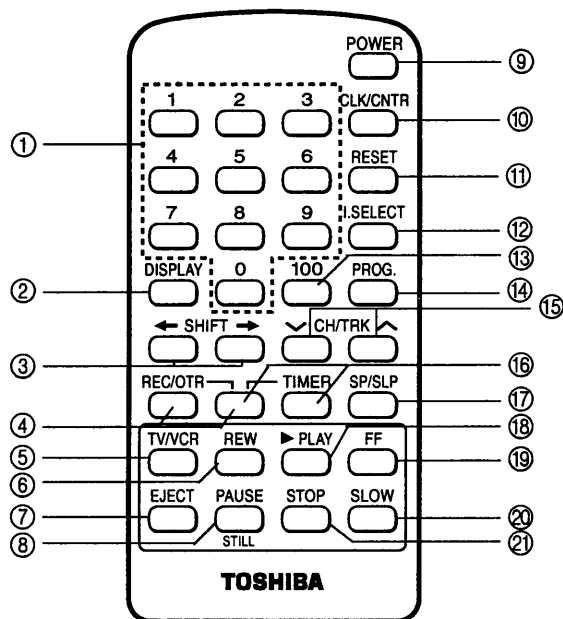

① Number Buttons (1-9, 0)

To select channels directly, press these buttons. Press two keys such as 02, 03,.... or 09 when a channel from 2 to 9 is desired.

Also, used to enter data for clock setting and timer recording.

② DISPLAY Button

Press to select the on-screen display mode from either on mode or off mode.

③ SHIFT ← / → Buttons

Press the buttons to return to the previous step or skip to the next step, when adjusting the clock or Timer program settings.

Also use these buttons for fine tuning.

④ REC/OTR Buttons

To start recording on a tape, press both buttons together. Repeatedly press both buttons to select a desired duration for the one-touch timer recording.

⑤ TV/VCR Button

To use the VCR tuner, press this button to select "VCR". To view the TV set, press this button so that the indication "VCR" disappears.

⑥ REW Button

In stop mode press to rewind the tape. In play mode press to visually search a desired portion of the video tape in the reverse direction. If the REW button is held down for more than 1 second, search speed will be faster until the button is released.

⑦ EJECT Button

Press to eject the cassette.

⑧ PAUSE/STILL Button

In recording mode, press to pause. In play mode, press for still frame.

⑨ POWER Button

Press to turn the VCR on and off.

⑩ CLK/CNTR Button

This button is used to display the clock (present time and date) or the tape counter.

⑪ RESET Button

Press to reset the counter to "0H00M00S".

⑫ I. SELECT Button

Press to select the auxiliary position (LINE).

⑬ 100 Button

To select channel numbers higher than 100, press this button first.

⑭ PROG. Button

Press to call up the MENU screen.

⑮ CH/TRK ^/V Buttons

Press to step up/down the TV channels for TV viewing. While the VCR is in playback mode, use these buttons to adjust tracking manually.

⑯ TIMER Buttons

To enter the timer recording standby mode, press both buttons together.

⑰ SP/SLP Button

Press to change the recording tape speed.

⑱ PLAY Button

Press to start playback of a pre-recorded tape.

⑲ FF Button

In stop mode, press to fast forward the tape. In play mode, press to visually search a desired portion of the video tape in the forward direction. If the FF button is held down for more than 1 second, search speed will be faster until the button is released.

⑳ SLOW Button

Press to perform slow playback.

㉑ STOP Button

Press to stop all the tape related functions.

Using the Remote Control Operation

This VCR can be operated with the remote control from up to a distance of about 23 feet (7 meters) and within an angle of 15 degrees either side of center.

There must be no obstacles between the remote control unit and the remote sensor of the VCR.

Battery Installation

- ① Remove the battery cover on the rear of the unit. (See Figure 1.)
- ② Install two size "AA" batteries into the battery compartment. (See Figure 2.)
- ③ Close the battery cover. (See Figure 3.)

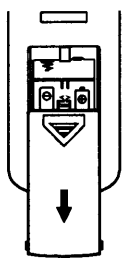

Fig. 1

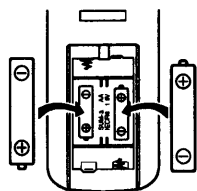

Fig. 2

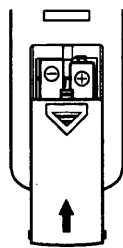

Fig. 3

Notes

- Be sure to install batteries properly to match the polarity diagrams drawn inside the battery compartment.
- Do not mix a new battery with an old one.
- Do not heat, disassemble, short or throw used batteries into a fire.

Precautions on Use

- Pressing two or more function buttons on the remote control unit (except **REC** buttons) at the same time may result in improper operation or damage.
- Do not place the remote control unit in an area where it may become wet.
- Do not place the remote control unit near high heat.
- Dropping the remote control unit on a hard surface may result in damage.
- Do not use benzene, thinner or other petroleum based solvent to clean the remote control unit. To clean, wipe a soft cloth slightly moistened with a mild detergent, and then wipe dry with a soft cloth.

Use of the Video Cassette

Only the video cassette tapes marked with VHS can be used in this VCR.

A cassette tape cannot be loaded or unloaded unless the AC power cord is connected to the AC outlet.

Loading and Unloading

Loading

Insert a cassette tape with its labeled side up as shown in the cassette compartment. The cassette will be automatically drawn inside the compartment.

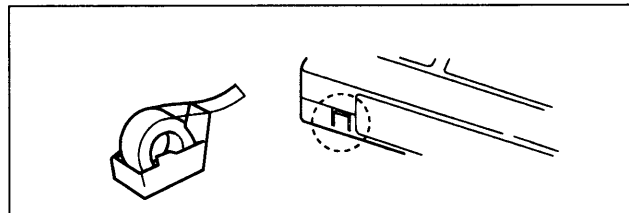
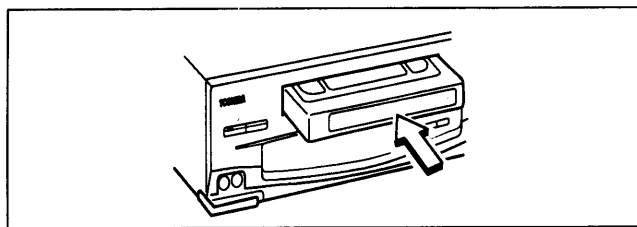

Unloading

- ① Press the **EJECT** button. The cassette will be ejected from the cassette compartment.
- ② Remove the cassette by pulling it toward you.

Tape Speeds and Maximum Recording Playback Time

Video Cassette Record Mode	T-160	T-120	T-60	T-30
SLP	480 min	360 min	180 min	90 min
LP	320 min	240 min	120 min	60 min
SP	160 min	120 min	60 min	30 min

- SP: Suitable for a general recording with better picture and sound quality.
 - SLP: Suitable for doubling recording time, but with less picture quality and sound than using the SP mode.
- * LP mode is only available during playback.

Care of the Video Cassette Tape

- Avoid violent vibration or shock.
- Do not place in a location where strong magnetic fields exist (near a motor, transformer or magnet).
- Never place or store in direct sunlight.
- Avoid dusty places.
- Place the cassette in the cassette case and store vertically.
- Never store tape in a humid location.

To Prevent Accidental Erasure

Every video cassette has a safety tab to prevent accidental erasure. Breaking off the safety tab is recommended for prevention from accidental erasure of the contents. If a tape without the safety tab is to be reused, cover the gap with a piece of adhesive tape.

Setting the VCR Output Channel

Set the 3-4 output channel selector on the rear panel to the vacant channel in your area (3 or 4).

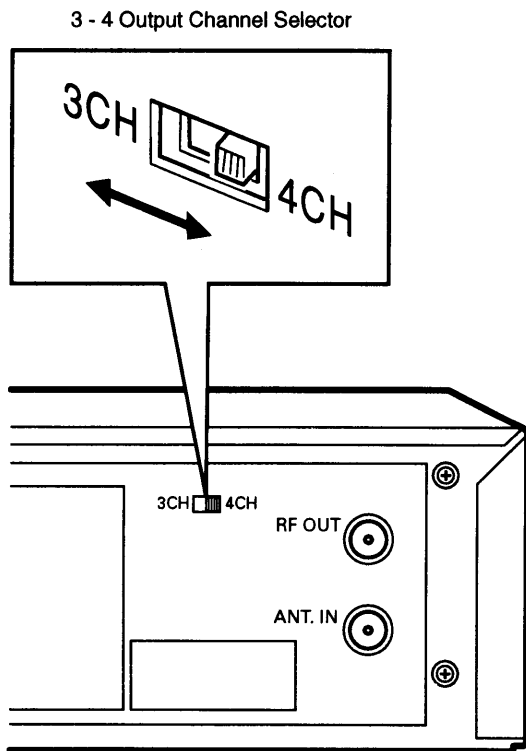

Using the TV/VCR Button on the Remote Control Unit

Use this button to select the TV mode or the VCR mode.

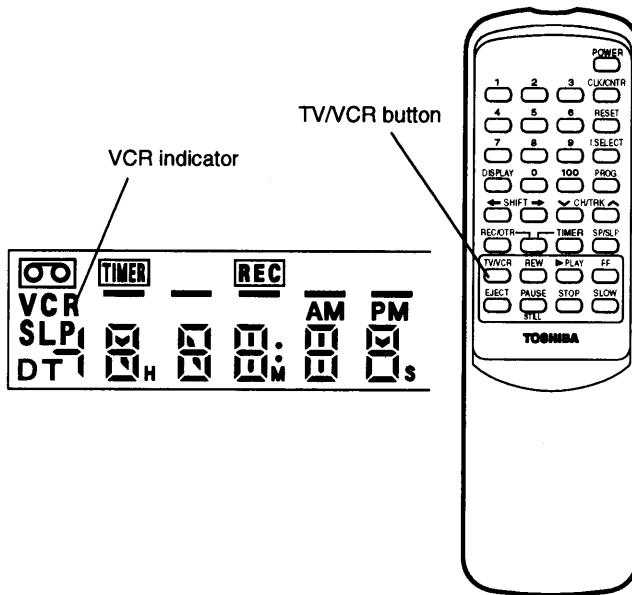

TV mode (using the TV Tuner)

- ① If the VCR power is OFF, simply turn your TV set ON. There is no need to turn the VCR ON.
- ② Select the channel you want to watch by using the channel select buttons of the TV set.

Note

If the VCR is ON and the VCR indicator "VCR" is lit on the VCR multi-display, press the **TV/VCR** button on the remote control unit so that "VCR" indicator is OFF.

VCR mode (using the VCR Tuner)

- ① Turn your TV set ON. Set your TV to the same channel as the VCR output channel selector (3 or 4).
- ② Turn the VCR power ON. The power indicator light will illuminate.
- ③ Press the **TV/VCR** button on the remote control unit to VCR mode. The "VCR" indicator light will illuminate on the VCR multi-display.
- ④ Use the **CHANNEL** buttons on the VCR or remote control unit to choose the channel you want to watch and/or record. The program on that channel will be shown on your TV screen.

Notes

- If you have cable TV, choose the channel which gives you the best reception.
- To play back a tape, set your TV to the same channel as the VCR output channel selector (3 or 4).

PREPARATION

Presetting the Language

Important

It is necessary to preset the LANGUAGE you want to use for the on-screen display before making any setting such as clock setting or channel memory. LANGUAGE setting is required when "12:00 AM" blinks in the multi-display after the VCR is first connected to an AC power source or after a power failure has occurred.

Example: To set the LANGUAGE to ENGLISH.

1. Turn on the TV.
2. Press the **POWER** button to turn the VCR on.
3. Press the **PROG.** button to enter the presetting mode. The LANGUAGE screen appears on the TV screen.

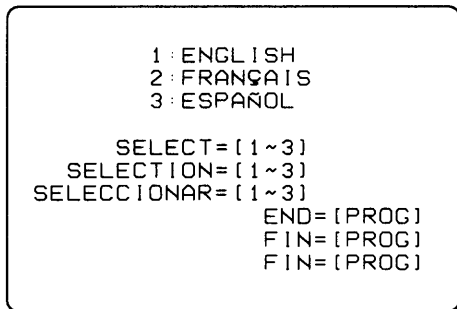

Notes:

- If the MENU screen appears, presetting the LANGUAGE has been made. You may skip this page.
 - To change the LANGUAGE setting, see "Using the Menu".
4. To set the language to ENGLISH, press the button **NUMBER 1**. The display changes to the MENU screen.

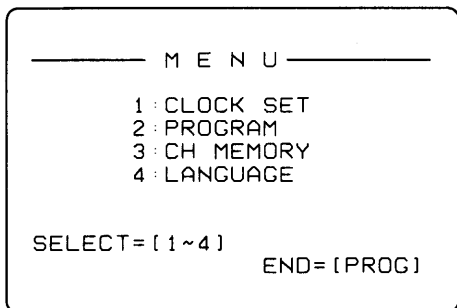

5. To return to the normal TV screen, press the **PROG.** button.

Using the Menu

When you want to perform the following operations, you must use the MENU screen:

- CLOCK SETTING
- TIMER PROGRAM setting
- CHannel MEMORY
- Display LANGUAGE setting

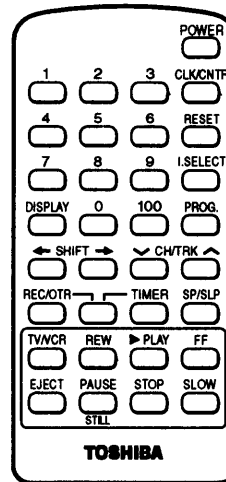

The basic operation is as follows:

1. Turn on the TV.
2. Press the **POWER** button to turn on the VCR.
3. Press the **PROG.** button. The MENU screen appears on the TV screen.

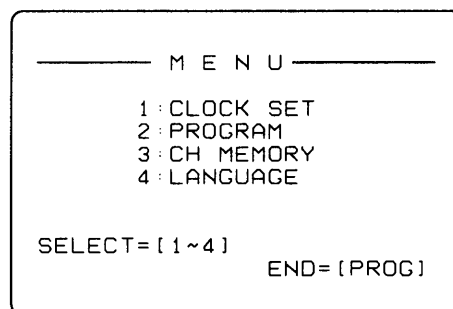

4. The **NUMBER** buttons 1-4 now can be used to select menu items.

Clock Setting

1. Press button **NUMBER 1**.
The CLOCK SET screen appears on the TV screen.

```
——— CLOCK SET ———  
  
(TIME) 12:00 AM  
(MONTH) (DATE) (YEAR)  
1 / 1 / '94  
SAT  
AM= [1] PM= [2]  
  
END= [PROG]
```

2. Enter the date and time with **NUMBER** buttons and press the **SHIFT** ← / → buttons to skip steps that do not require adjustments.

Timer Program

1. Press button **NUMBER 2**.
The PROGRAM screen appears on the TV screen.

```
——— PROGRAM ———  
  
10:20AM 12/11/94 (MON)  
1  
2 8CHDATE --- --AM--- --AM SP  
3  
4  
ONCE= [1] DAILY= [2]  
WEEKLY= [3]  
CANCEL= [RESET] END= [PROG]
```

2. Enter the program data with **NUMBER** buttons and press the **SHIFT** ← / → buttons to skip steps that do not require adjustments.

Channel Memory

1. Press button **NUMBER 3**.
The CH MEMORY screen appears on the TV screen.

```
——— CH MEMORY ———  
  
1: TV/CATV (TV)  
2: AUTO SCAN  
3: ADD CH  
4: ERASE CH  
  
SELECT= [1~4] END= [PROG]
```

2. The **NUMBER** buttons 1-4 can now be used to select the following operations.

- Antenna switching (TV/CATV)
- Auto channel memory (AUTO SCAN)
- Add channel
- Erase channel

Display Language Setting

1. Press button **NUMBER 4**.
The LANGUAGE screen appears on the TV screen.

```
1: ENGLISH  
2: FRANÇAIS  
3: ESPAÑOL  
  
SELECT= [1~3]  
SELECTION= [1~3]  
SELECCIONAR= [1~3]  
END= [PROG]  
FIN= [PROG]  
FIN= [PROG]
```

2. Select the display language with **NUMBER** buttons 1-3.

Notes:

- To quit the MENU mode, press the **PROG.** button again.
- When LINE(L) position is selected, or during playback or recording, the CH MEMORY screen cannot be selected.

Setting the VCR Clock

After installing the VCR, you must set the date and time before setting a timer program.

When the VCR is plugged into an AC outlet at the initial installation, the clock built in to the VCR starts from 12:00 AM.

PRIOR TO SETTING

1. If you inadvertently press an incorrect button, a "*" appears when the incorrect button is pressed.
2. The **SHIFT** ← / → buttons are used to skip items that do not require adjustment.

EXAMPLE:

Setting at 8:30 PM on Sunday 5th June in 1994.

PROCEDURE:

1. Press the **PROG.** button to call up the MENU screen.

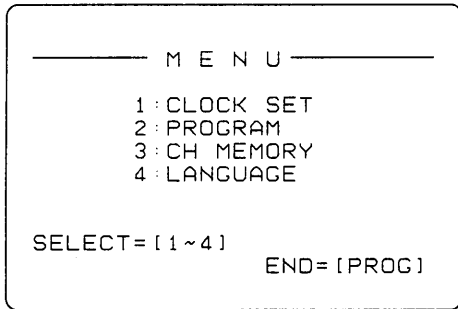

2. Press button **NUMBER 1**. The **CLOCK SET** screen appears on the TV screen. The hour position will blink.

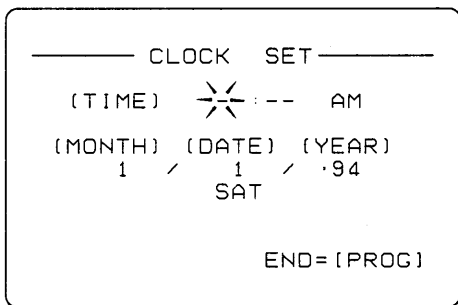

3. Press button **NUMBER "0"** and then "8" to set the hour indication to "8". The minute indication now blinks. If the hour indication is correct, skip this step by pressing the **SHIFT** ← / → buttons.

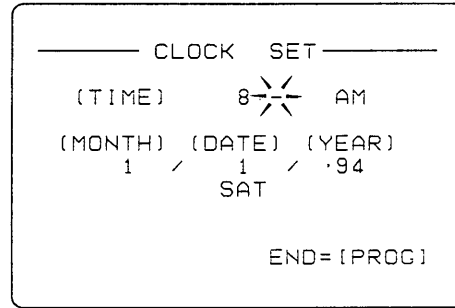

4. Press button **NUMBER "3"** and then "0" to set the minute indication to "30".

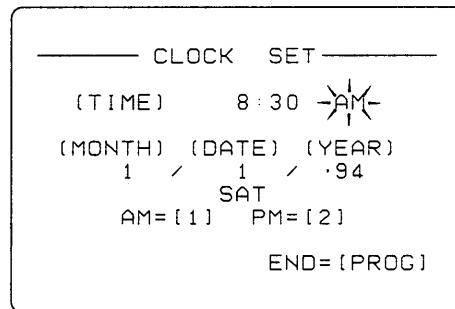

5. Press button **NUMBER "2"** to set the AM/PM indication to "PM".

Button 1 AM
Button 2 PM

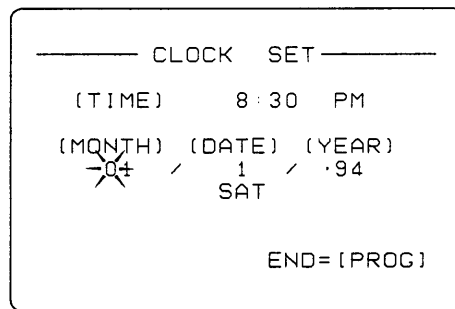

- Press button **NUMBER** "0" and then "6" to set the month indication to "6".

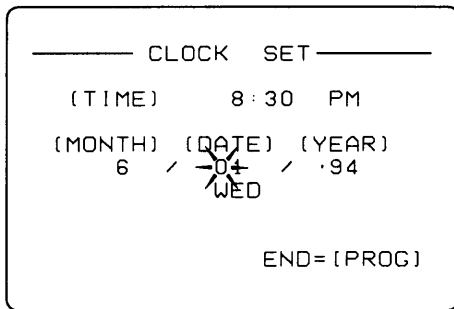

- Press button **NUMBER** "0" and then "5" to set the date indication to "5".

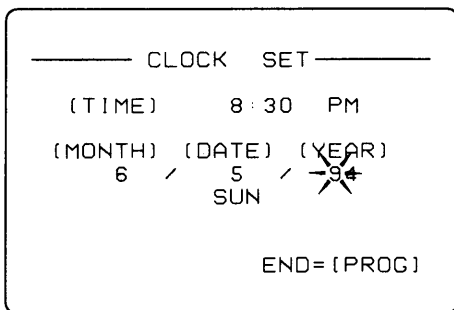

- Press button **NUMBER** "9" and then "4" to set the year indication to "94".

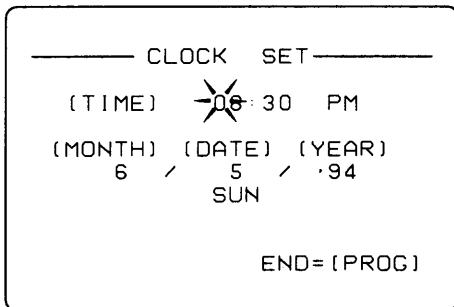

- Press the **PROG.** button.
The present time and date setting is now completed and the clock starts from zero seconds. The MENU screen is resumed.

HINTS ON CLOCK SETTING

- To set the time exactly to the second, press the **PROG.** button at the exact time corresponding with a time signal from an accurate clock, radio, telephone and so on in step 9 above.
- With the memory back-up circuitry incorporated in this unit, the programming data for the clock and timer recording can be retained securely when a power failure of approximately 1 minute or less occurs.

Operating the FS Tuner

This VCR has an FS (Frequency Synthesized) tuner and is designed to receive the following TV signals and CATV signals.

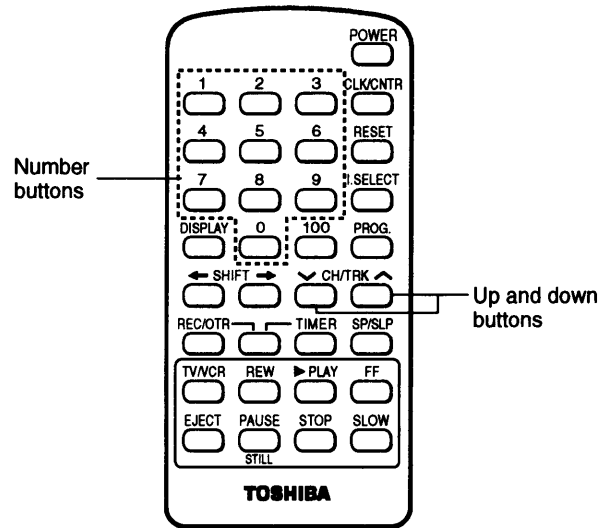

Setting the CATV Mode

- Press the **PROG.** button to call up the MENU screen. Press button **NUMBER** 3. The CH MEMORY screen appears on the TV screen.

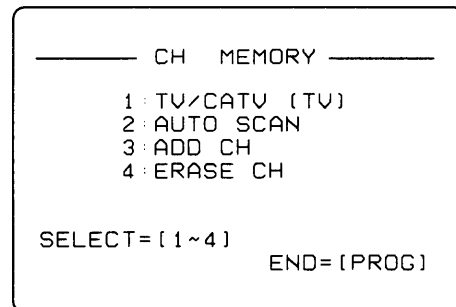

- Each time you press button **NUMBER** 1, the display changes between TV/CATV (TV) and TV/CATV (CATV).

Note:

When LINE(L) position is selected, or during playback or recording, the CH MEMORY screen cannot be selected.

To Select CATV Signals

This VCR is designed to select CATV signals (STD/HRC/IRC) automatically.

Channel Select

1. To Tune with the Number Buttons 1-9 and 0 (Remote Control Unit only)

Press the **NUMBER** buttons to be tuned.

- A) For a one-digit channel (2-9), press button **NUMBER** 0 and then the appropriate digit.
When setting channel 9:
Press button **NUMBER** "0" and then "9".

Only CATV signal 1-9, 100 and TV channels 2-9 can be selected by pressing the appropriately numbered key.

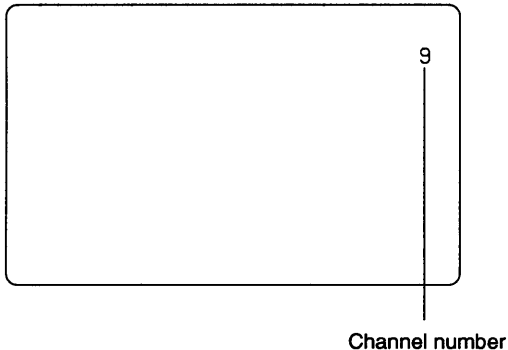

- B) For a two-digit channel (10-69 and 70-99 of Cable channels), press the first digit, then the second digit.
When setting channel 15:
Press button **NUMBER** "1" and then "5".

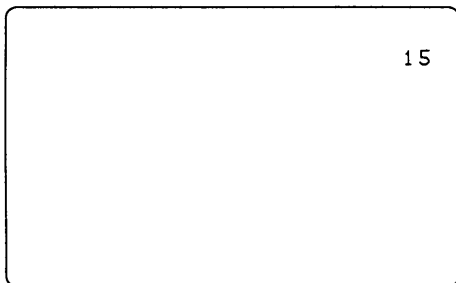

- C) For the three-digit channels (100-125 of Cable channels), press the 100 button to enter the first digit, then press second digit and third digit in sequence.
When setting channel 125:
Press the 100 button, **NUMBER** button "2" and "5" in sequence.

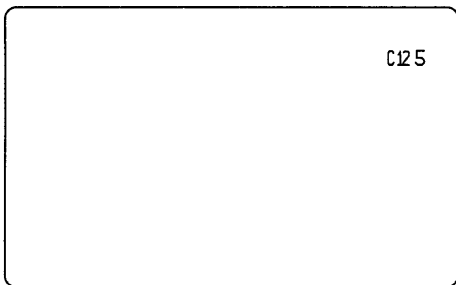

The channel will be automatically tuned within few seconds.

Notes:

- If you don't enter the first digit for a two or three digit channel within few seconds, the previous channel will appear on the screen.
- With OSD on, the channel number displayed on the TV screen will not disappear from the screen. Otherwise it will disappear within few seconds.
- If a channel other than those that are valid is entered, it will not be register and the previous channel will be returned.

2. Using the CHANNEL UP (^) /DOWN (v) buttons: (front panel or remote control)

Press and release the **CHANNEL UP** (^) /**DOWN** (v) buttons. The channel steps up or down automatically.

• TV mode

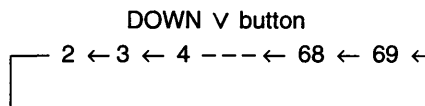
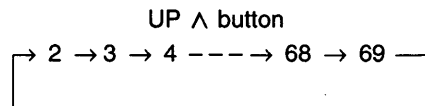

• CATV mode

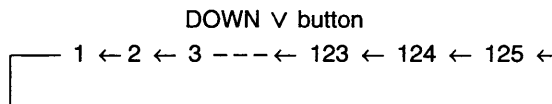
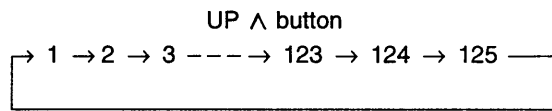

Notes

- If the **CHANNEL** button is pressed and immediately released, the channel steps up or down to the next channel.
- If the **CHANNEL** button is held down for longer than 0.5 second, channels will keep changing until the button is released.

Fine Tuning

If a clear picture does not appear on the TV screen after channel selection, use the fine adjustment function.

Press the **SHIFT** ← / → buttons with holding the "⌈" button (between the **REC/OTR** button and **TIMER** button) until the best possible picture is obtained.

- Press the **SHIFT** → button with holding the "⌈" button to tune to higher frequencies.
- Press the **SHIFT** ← button with holding the "⌈" button to tune to lower frequencies.

TV/CATV Channel Display

When selecting TV or CATV channels, the specified TV or CATV channel number is displayed on the TV screen.

To Select LINE Position

The LINE (auxiliary input) position (displayed as "L") may be selected by pressing the **I. SELECT** button. When the LINE position is selected, recording from an external A/V source may be performed with the AUDIO/VIDEO IN jacks connected to an external source via PHONO connector lead(s).

1. Press the **I. SELECT** button to select the LINE position.
2. To resume TV/CATV channels, press the **I. SELECT** button again or select the desired channel with **CHANNEL** or **NUMBER** buttons.

Channel Memory

When selecting a channel with the **CHANNEL** \wedge /V buttons, you can skip over an undesired channel by erasing it from channel memory. The erased channel can be restored by adding it again.

Note

Even if the channel has been erased, you can still select the erased channel with the **NUMBER** buttons.

Auto Channel Scanning

This operation allows you to automatically store all channels that can be received in your area.

1. Press the **PROG.** button to call up the MENU screen. Press button **NUMBER 3**. The CH MEMORY screen appears on the TV screen.

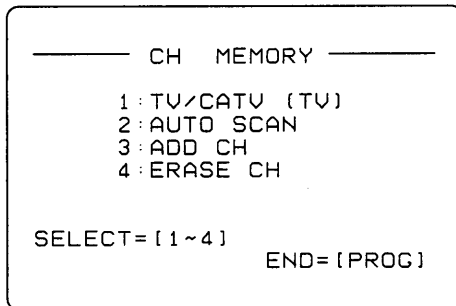

2. Press button **NUMBER 2** to select the AUTO SCAN mode. The indication "AUTO SCAN" blinks on the TV screen and starts scanning all the receivable channel from the lowest channel.

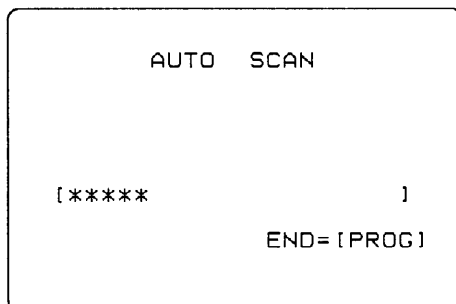

When the VCR completes scanning all the receivable channels, the normal TV screen will be restored.

Erasing the Channel Position

1. Select the channel to be erased with the **CHANNEL** \wedge /V buttons or **NUMBER** buttons.
2. Press the **PROG.** button to call up the MENU screen. Press button **NUMBER 3**. The CH MEMORY screen appears on the TV screen.
3. Press button **NUMBER 4** to select the ERASE CH mode. The indication "ERASE CH" blinks on the TV screen and the current channel will be deleted.

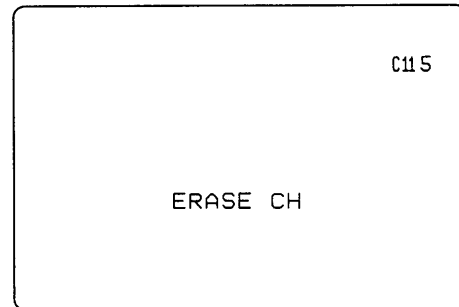

After 3 seconds, the normal TV screen will be restored.

Adding the Channel Position

1. Select the channel to be restored (added) with **NUMBER** buttons.
2. Press the **PROG.** button to call up the MENU screen. Press button **NUMBER 3**. The CH MEMORY screen appears on the TV screen.
3. Press button **NUMBER 3** to select the ADD CH mode. The indication "ADD CH" blinks on the TV screen and the current channel will be restored.

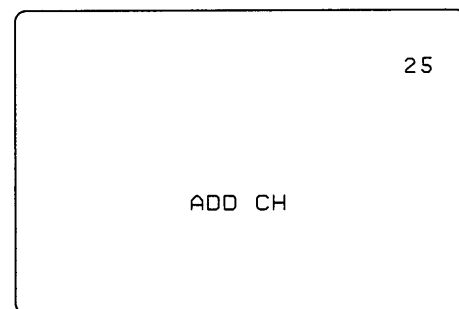

After 3 seconds, the normal TV screen will be restored.

Channel Reference Chart

The cable channels are numerically indicated in the multi-display in place of each actual channel name originally assigned. Refer to the chart below for cable channel numbers to be shown.

BAND	CH NAME	DISPLAY
VHF LOW BAND	1	1
	2	2
	3	3
	4	4
	A-7	5
	A-6	6
CATV MID BAND	A-5	95
	A-4	96
	A-3	97
	A-2	98
	A-1	99
	A	14
	B	15
	C	16
	D	17
	E	18
	F	19
	G	20
VHF HIGH BAND	H	21
	I	22
	7	7
	8	8
	9	9
	10	10
CATV SUPER BAND	11	11
	12	12
	13	13
	J	23
	K	24
	L	25
	M	26
	N	27
	O	28
	P	29
	Q	30
	R	31
	S	32
T	33	
U	34	
V	35	

BAND	CH NAME	DISPLAY
CATV HYPER BAND	W	36
	AA	37
	BB	38
	CC	39
	DD	40
	EE	41
	FF	42
	GG	43
	HH	44
	II	45
	JJ	46
	KK	47
	LL	48
	MM	49
	NN	50
	OO	51
	PP	52
	QQ	53
	RR	54
	SS	55
	TT	56
	UU	57
	VV	58
	WW	59
	XX	60
	YY	61
	ZZ	62
	AAA	63
	BBB	64
CCC	65	
66	66	
67	67	
68	68	
69	69	
70	70	
71	71	
72	72	
73	73	
74	74	
75	75	
76	76	
77	77	
78	78	
79	79	

BAND	CH NAME	DISPLAY
CATV HYPER BAND	80	80
	81	81
	82	82
	83	83
	84	84
	85	85
	86	86
	87	87
	88	88
	89	89
	90	90
	91	91
	92	92
	93	93
	94	94
	100	100
	101	101
	102	102
	103	103
	104	104
	105	105
	106	106
	107	107
	108	108
	109	109
110	110	
111	111	
112	112	
113	113	
114	114	
115	115	
116	116	
117	117	
118	118	
119	119	
120	120	
121	121	
122	122	
123	123	
124	124	
125	125	

Notes

- Since cable services may vary from area to area, please consult your local cable company for cable compatibility.
- Direct tuning to cable channels is limited to unencoded (unscrambled) channels only.

On Screen Display (OSD)

You can display the on-screen information which tells you the tape operation mode, the channel selected, the recording speed, the tape count, and the date and time.

To call up the on-screen information, press the **DISPLAY** button on the remote control unit.

All information (operation mode, channel selected, recording speed, tape count and current date, time) is displayed.

Each time the **DISPLAY** button is pressed, the on-screen display changes as follows:

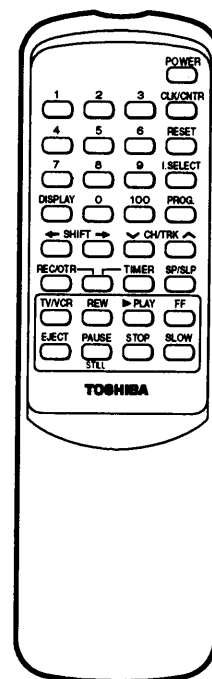
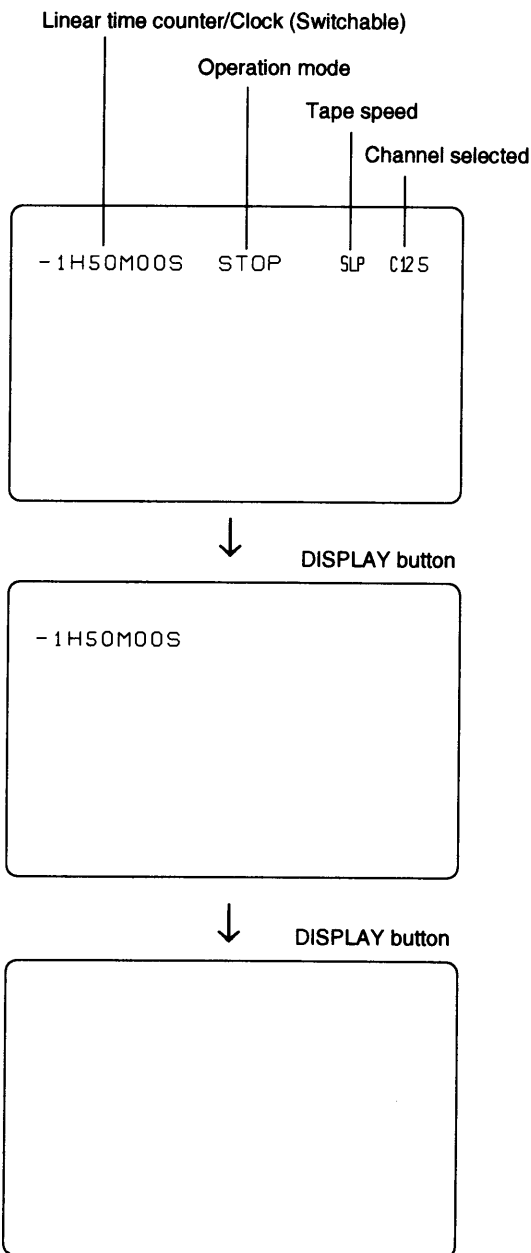

OPERATION	DISPLAY
Playback	PLAY
Recording	REC
Fast forward	FF
Rewind	REW
Pause	PAUSE
Stop	STOP
Cassette in/out	 blinking
OTR	1H30M OTR
Timer recording	REC

Even if the VCR is in OSD off mode, the superimposed information will appear on the TV screen for a few seconds when you press any tape operation button or when you select a channel. After a few seconds, it disappears from the screen. When OSD is on, the on-screen information remains on the screen.

PLAYBACK

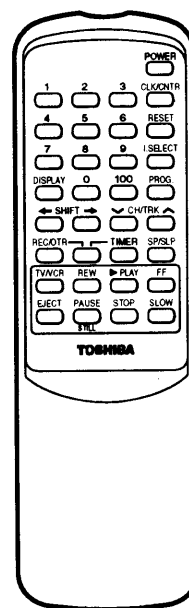
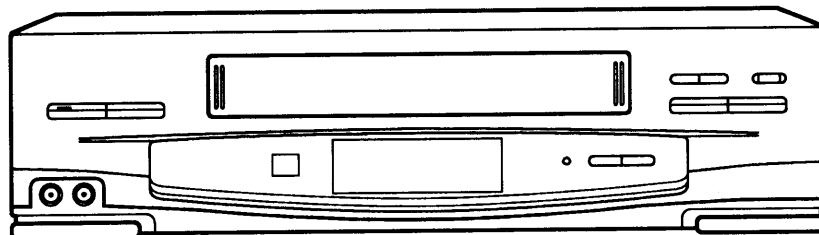

Basic Playback

- ① Press the **POWER** button.
- ② Insert a cassette tape into the CASSETTE LOADING SLOT.
- ③ Turn on the TV and select channel 3 or 4 for video viewing.
- ④ Press the **PLAY** button to start playback.

To stop playback:

Press the **STOP** button.

To rewind a tape in Stop mode:

Press the **REW** button.

To advance a tape rapidly in Stop mode:

Press the **FF** button.

To stop fast forwarding or rewinding:

Press the **STOP** button.

Digital Tracking

When the cassette is first inserted and the **PLAY** button is pressed, the VCR enters digital tracking mode. At this time, the indication "DT" blinks on the multi-display for a few seconds.

When the playback speed is changed, the digital tracking operation is performed for the selected speed. The indication "DT" will blink on the multi-display for a few seconds.

Ordinarily use the digital tracking function. To enter digital tracking mode, press the two **CH/TRK** \wedge/\vee buttons simultaneously for more than 2 seconds.

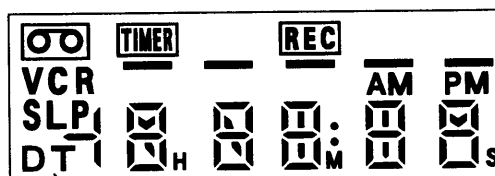

Digital Tracking Indicator

Notes

1. If video noise appears in the picture after putting the VCR into digital tracking mode, use the manual tracking adjustment function. Press the **CH/TRK** \wedge/\vee buttons until the best possible picture is obtained.
2. If you press the two **CH/TRK** \wedge/\vee buttons simultaneously, the tracking will be adjusted to the center.

Auto Rewind System

When a tape reaches its end in Playback, Fast Forward or Record mode (except Timer Program Recording), it will automatically be rewound to its beginning and the unit will switch to the Stop mode.

Auto Playback System

Simply insert a cassette tape without a safety tab into the cassette loading slot while the unit is turned off. The following operations (1 through 5) will occur automatically.

1. The VCR is turned on.
2. The cassette tape is played back to its end.
3. The tape is rewound to the beginning. (Auto Playback)
4. The cassette tape is ejected from the cassette loading slot.
5. The VCR is turned off. (Full Auto Playback)

Quick Play System

Playback will start approximately 1 second after the **PLAY** button is pressed.

Note

The Auto Playback or Full Auto Playback mode will be released if one of the tape related buttons (**FF**, **REW**, **PAUSE/STILL**, **EJECT**, **STOP**, **PLAY** or **POWER**) is pressed.

RECORDING

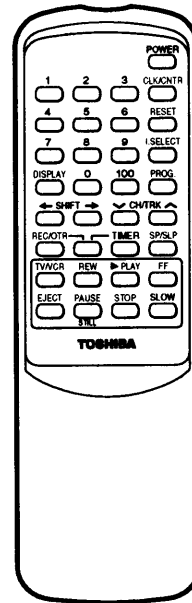
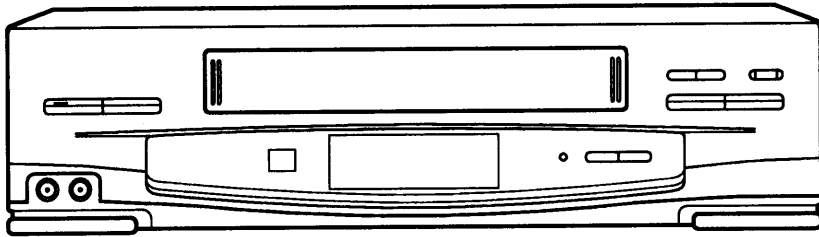

Basic Manual Recording

- ① Press the **POWER** button.
- ② Press the **TV/VCR** button on the remote control unit so that the VIDEO indication appears on the TV screen.
- ③ Select a desired channel to be recorded, using **CHANNEL** Δ /**V** buttons or the **NUMBER** buttons and the 100 button on the remote control unit.
- ④ Insert a cassette tape with the safety tab in place.
- ⑤ Press the **SP/SLP** button to select the tape recording speed (SP or SLP). The tape speed indication appears on the TV screen.
- ⑥ Press the **REC/OTR** button on the unit or the two **REC/OTR** buttons on the remote control unit simultaneously to start recording.
- ⑦ To end recording, press the **STOP** button.

Notes

- If the tape reaches its end during recording, it will automatically be rewound to its beginning and the unit will be switched to Stop mode.
- If a cassette without the safety tab is inserted, it will be automatically ejected when the **REC/OTR** button is pressed. This protects the recorded contents on the tape against accidental erasure.
- To change channels or eject a cassette tape during recording, first set the VCR to Pause mode by pressing the **PAUSE/STILL** button, and then change channels or eject the cassette.

Checking the Picture Being Recorded

Turn on the TV and tune to channel 3 or 4 for video viewing.

Watching Another TV Program While Recording

1. While recording, press the **TV/VCR** button on the remote control unit to set the VCR to TV mode. The "VCR" indication on the multi-display goes OFF.
2. Select the desired TV channel with the TV tuner.
3. Press the **TV/VCR** button when a TV program is finished. The VCR indicator on the multi-display lights. Next set the TV channel to 3 or 4 (according to the setting of VCR 3-4 output channel selector).

PAUSE/STILL button

Use this button when you want to skip unnecessary scenes during recording or to edit a prerecorded tape.

1. Press the **PAUSE/STILL** button during recording to stop recording momentarily.
2. Press the **PAUSE/STILL** button again to resume recording.

Notes

- If the VCR is left paused for more than 5 minutes, it will automatically enter the stop mode to prevent damage to the tape.
- The recorded pictures on the tape may be distorted near where the **PAUSE/STILL** button is used. This is not a malfunction.

ONE-TOUCH TIMER RECORDING (OTR)

This allows you record for up to 4 hours with automatic turn-off.

1. Press the **REC/OTR** button on the unit or the two **REC/OTR** buttons on the remote control unit simultaneously during recording.
The VCR enters OTR mode.
2. Select the recording duration by pressing the **REC/OTR** button repeatedly. The OTR indication appears on the TV screen.

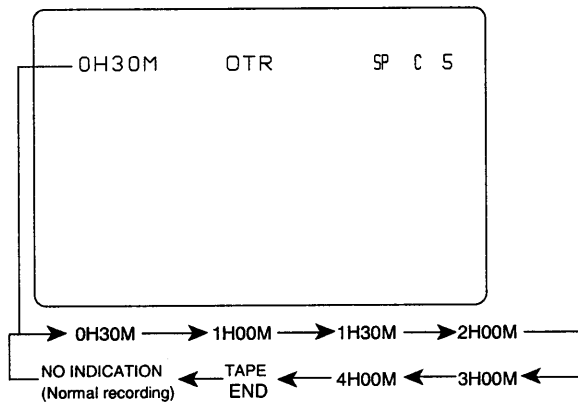

The OTR recording will start immediately.

Notes

1. When the selected recording time has elapsed, the OTR mode will be automatically released and the unit will turn off.
2. If the **REC/OTR** button is pressed during OTR recording, the remaining recording time is indicated on the TV screen and is automatically reduced.

Changing OTR Duration

The OTR duration can be changed by pressing the **REC/OTR** button even after the OTR recording has started.

When the **REC/OTR** button is pressed once, the next recording duration is selected.

e.g. When the remaining recording time is 13 minutes, the indication changes:

0H13M → 0H30M → 1H00M → ...

Notes

1. If a cassette without a safety tab is inserted, it will be automatically ejected when the **REC/OTR** button is pressed.
2. If the tape reaches its end during OTR recording, it will be automatically stopped and the unit will be turned off.
3. When OTR recording has finished, the VCR will automatically switch to Timer Recording Standby mode if there is Timer program data.

COUNTER FUNCTION

Counter Display

When a cassette tape is inserted, the counter display appears. The counter starts counting up or down when the **PLAY**, **REC/OTR**, **FF** or **REW** button is pressed.

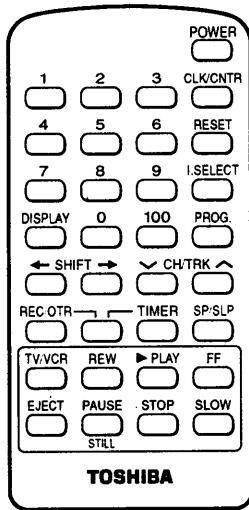

Note

The counter display automatically reverts to the clock display when the unit is turned off or a cassette tape is ejected.

CLOCK/COUNTER Display Switching

To change the counter display to the clock display, press the **CLK/CNTR** (clock/counter) button on the remote control unit.

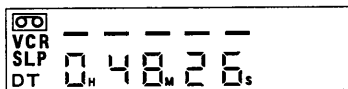

Counter Display

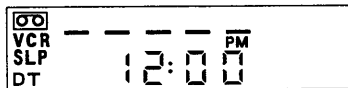

Clock Display

Counter Reset

To reset the counter to "0:00:00", press the **RESET** button on the remote control unit.

Note

The **RESET** button will not function if the clock display is shown in the multi-display.

SPECIALIZED EFFECTS

Picture Search

You can advance or rewind a tape rapidly without a picture using the **FF** or **REW** button. Picture Search operation is convenient to locate a desired portion of the tape quickly while viewing the picture on the screen.

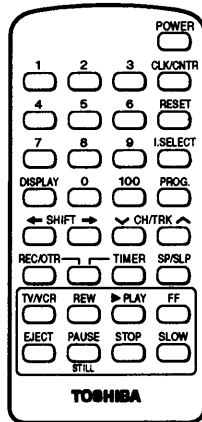

Forward Search

To view high-speed picture search in the forward direction:

1. In the Playback mode or in the FF mode, press the **FF** button.
2. To resume normal playback, press the **PLAY** button.

To search faster in the forward direction:

If the **FF** button is held down for more than 1 second, search speed will be faster until the button is released.

Reverse Search

To view high-speed picture search in the reverse direction:

1. In the Playback mode or in the REW mode, press the **REW** button.
2. To resume normal playback, press the **PLAY** button.

To search faster in the reverse direction:

If the **REW** button is held down for more than 1 second, search speed will be faster until the button is released.

Notes

1. The audio output is muted during picture search operation.
2. Noise bars appear on the picture during picture search. This does not indicate a malfunction of the VCR.
3. **Noise bars on the picture may increase and audio noise may be heard with a tape recorded in SP tape speed. (Model: M-250)**
4. **The color of the picture may be lost during picture search with a tape recorded in SP tape speed. (Model: M-250)**

Still Frame

This function enables you to freeze a picture to watch important scenes closely.

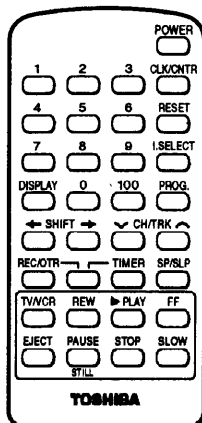

1. In the Playback mode, press the **PAUSE/STILL** button to freeze the picture.
 2. To resume normal playback, press the **PAUSE/STILL** button again.
- If the picture is distorted during Still Frame (or Slow Playback), press the **CH/TRK** \wedge / \vee button to correct the picture (it may not always be possible to eliminate the distortion completely).

Notes

1. If the VCR is left in Still mode for longer than five minutes, it will automatically release still mode to prevent damage to the tape.
2. The audio output is muted in Still mode.
3. A tape recorded in LP mode can be played back, but special playback functions such as still and slow playback is not assured.
4. **The picture may be distorted and audio noise may be heard during still frame in SP mode. This is normal. (Model: M-250)**

Slow Playback

1. Press the **SLOW** button to perform slow playback.
2. Each time this button is pressed, the speed changes as follows:

1/6 → 1/18 → 1/6 → 1/18 →....

3. To return to normal play, press the **PLAY** button.
- Press the **CH/TRK** \wedge / \vee button during Slow Playback to move noise bars up and down.
Press the **PAUSE/STILL** button when the screen obtains the best picture for a still frame.

Note

The picture may be distorted and audio noise may be heard during slow playback in SP mode. This is normal.
(Model: M-250)



PROGRAMMABLE TIMER RECORDING

A maximum of 4 events can be programmed within a period of 1 month, including the present day, for Timer Recording.

A timer recording can be activated at the same time every day (MO-FR), weekly, or on a particular day.

You can perform mixed programming of CATV and TV channels.
You must use the PROGRAM screen for setting timer programs.

Prior to Programming

1. Make sure of the following:
 - The inserted cassette tape is equipped with a safety tab.
 - The clock is showing the current time, including the date and the AM/PM indication.
 - The VCR is not set to the timer recording standby mode. Confirm that the **TIMER INDICATOR** on the multi-display is not on.
2. If you inadvertently press an incorrect button, a "*" will appear.
3. You can go back or skip unnecessary steps in the timer setting procedure by pressing the **SHIFT** ← / → buttons.

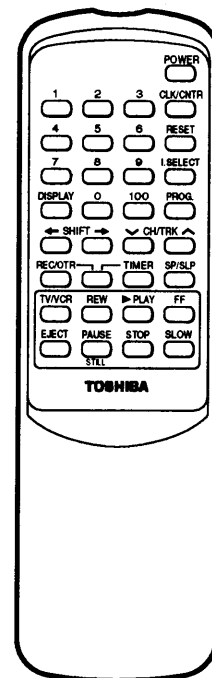

EXAMPLE:

Current time ... 12:00 AM Sunday, 5th June, 1994.
 To program the timer recording of TV channel 45, from
 7:30 PM to 8:25 PM on Tuesday 7th June in SP mode.

PROCEDURES:

- ① Press the **PROG.** button.
 The MENU screen appears.

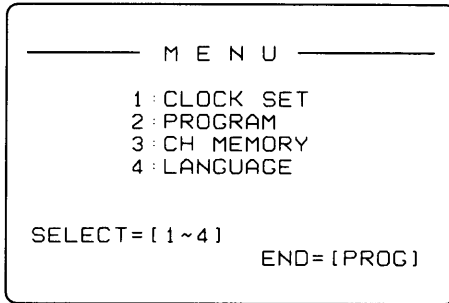

- ② Press button **NUMBER 2**.
 The PROGRAM screen appears.
 You can set the data for timer recording while observing
 this display and confirm the programmed data at any
 time.
 The middle four numbers show the data set lines to which
 you must enter program data for a corresponding timer
 programming.

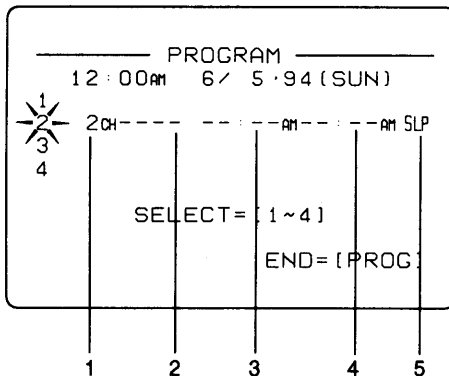

- 1 Channel number
 2 Program execution day
 3 Program start time
 4 Program end time
 5 Recording tape speed

- ③ Press **NUMBER** buttons 1-4 to select the data set line.
 For this example, select the second data set line. Press
 button **NUMBER 2**.

- ④ The indication "2CH" or "C 1CH" blinks in the CHANNEL
 setting position.

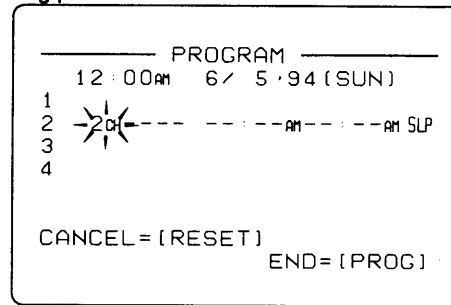

Press the **NUMBER** buttons or **CH/TRK** \wedge / \vee buttons to
 select the channel number. For this example, press
 button **NUMBER "4"** and then "5".

- ⑤ The indication "DATE" blinks in the DATE setting position.
 Press **NUMBER** buttons 1-3 to select the recording ex-
 ecution date mode.

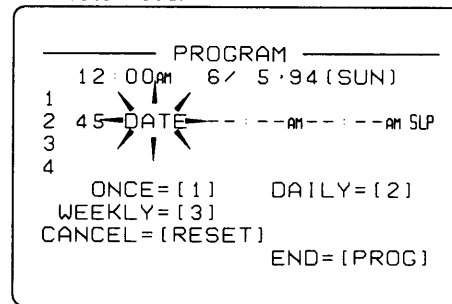

- Button 1 ONCE :** On a particular day
Button 2 DAILY : At the same time every day (Mon-
 day to Friday)
Button 3 WEEKLY: At the same time on the same day
 of the week

For this example, select "ONCE" mode. Press button
NUMBER 1.

- You can also set DAILY and WEEKLY timer recordings.
 See page 37.

- ⑥ The indication "0" blinks at the DATE setting position.
 Press the **NUMBER** buttons to select the program ex-
 ecution day.
 For this example, press button **NUMBER "0"** and then
 "7".

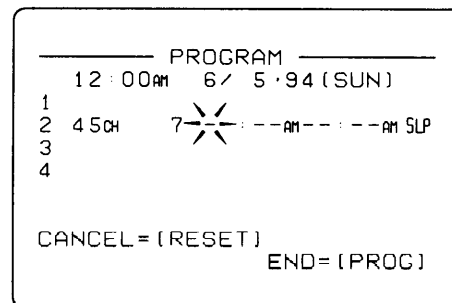

- ⑦ The indication “—” blinks in the START hour setting position.
Press the **NUMBER** buttons to set the program start hour.
For this example, press button **NUMBER** “0” and then “7”.
- ⑧ The indication “—” blinks in the START minute setting position.
Press the **NUMBER** buttons to set the program start minute.
For this example, press button **NUMBER** “3” and then “0”.
- ⑨ Then press button **NUMBER** 1 or 2 to select “AM” or “PM”.

Button 1 AM
Button 2 PM

For this example, press button **NUMBER** “2”.

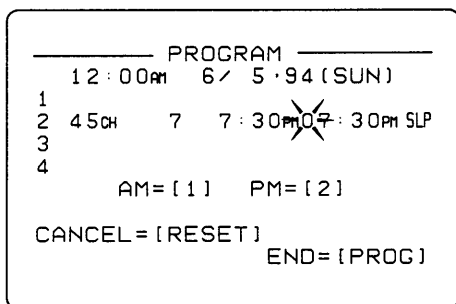

- ⑩ The indication “—” blinks in the END hour setting position.
Press the **NUMBER** buttons to set the program end hour.
For this example, press button **NUMBER** “0” and then “8”.
- ⑪ The indication “3” blinks in the END minute setting position.
Press the **NUMBER** buttons to set the program end minute.
For this example, press button **NUMBER** “2” and then “5”.
- ⑫ Then press button **NUMBER** 1 or 2 to select “AM” or “PM”. For this example, press button **NUMBER** “2”.

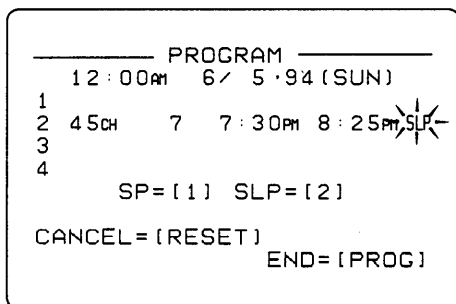

- ⑬ The indication “SLP” blinks in the SPEED setting position.
Press button **NUMBER** 1 or 2 to set the recording tape speed.

Button 1 SP
Button 2 SLP

For this example, press button **NUMBER** “1”.

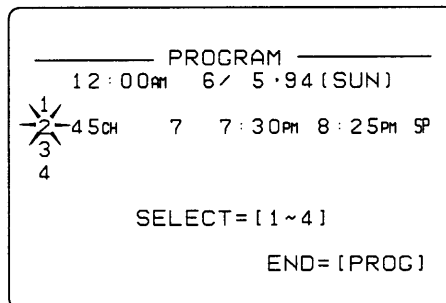

- ⑭ Program setting for the data set line “2” is finished. If you want to set other program settings, repeat steps 3 to 13.
- ⑮ Press the two **TIMER** buttons simultaneously to enter timer recording standby mode.
The **TIMER** indicator will light up.

Normal Playback and Recording in the Timer Standby mode

- Normal playback and recording are possible to the timer standby mode.
 - 1) Press the two **TIMER** buttons simultaneously during timer recording standby mode. The **TIMER** indicator will disappear.
 - 2) Press the **POWER** button to turn on the VCR.
 - 3) Follow the procedure for normal playback or recording.
 - 4) Press the **TIMER** buttons again after playback or recording. The VCR returns to the timer standby mode.

Daily Recording Setting

You can activate the timer recording on the same channel at the same time Monday through Friday.

1. In step 5 on page 35, press button **NUMBER 2** to select the DAILY recording mode.
The indication "MO~FR" appears in the DATE setting position.
2. Perform steps 7 to 15 of the procedure on page 36.

Weekly Recording Setting

You can record TV programs on the same channel on the same day every week.

1. In step 5 on page 35, press button **NUMBER 3** to select the WEEKLY recording mode.
The indication "WKLY" blinks in the DATE setting position.
2. Press the **NUMBER** buttons 1-7 to select the recording execution day.

Sunday	Monday	Tuesday	Wednesday	Thursday	Friday	Saturday
1	2	3	4	5	6	7

3. Perform steps 7 to 15 of the procedure on page 36.

Notes on Timer Settings

- The VCR will turn on 15 seconds prior to the programmed recording start time and enter pause mode. Timer recording starts on time.
- If the cassette has no safety tab when you press the **TIMER** buttons to put the VCR in timer recording standby mode, the cassette will be automatically ejected.
- "—E—" (error) will be displayed on the multi-display when the **TIMER** buttons are pressed under the following conditions and TIMER Recording Standby mode will not be activated.
 - * There is not video cassette in the VCR.
 - * No timer program has been set.
- In step 2 on page 35, if the clock has not been set, the CLOCK SET screen is automatically displayed when button **NUMBER 2** is pressed.
- If the **PROG.** button is pressed in steps 4 through 15, the blinking item will be cleared.

Clearing the Programmed Data

1. Press the two **TIMER** buttons simultaneously to release the timer recording standby mode.
2. Press the **PROG.** button to call up the MENU screen.
3. Press button **NUMBER 2** to call up the PROGRAM screen.
4. Press the appropriate **NUMBER** button to select the data set line to be cleared.
The message "CANCEL=[RESET]" will appear on the screen.
5. Press the **RESET** button to clear all data of the selected data set line.
6. If you want to clear data partially and enter new data, press the **SHIFT** ← / → buttons until the blinking position moves to the desired setting position to be cleared. Then change the settings.

Confirming the Programmed Data

1. Press the **PROG.** button during timer recording standby mode.
The PROGRAM screen appears on the TV screen, showing all the program data that has been set.
2. After confirming the data, press **PROG.** button again to quit confirmation mode.
3. Confirmation mode is automatically canceled after 1 minute.

Confirming the Programmed Data Being Executed

1. Press the **TV/VCR** button.
2. Press the **PROG.** button. The PROGRAM screen appears on the TV screen, showing all the program data that has been set.
3. After confirming the data, press the **PROG.** button and return to the screen in REC mode.

When a timer recording is executed, the programmed data except for the everyday or weekly recording data is erased. If a power failure occurs or the power cord is unplugged, the programmed data will be erased. The clock display will display "12:00 AM". Reset the clock display and re-enter the data for the timer recording.

When two programs overlap

- If the start time of the later program overlaps the recording period of the earlier program, the later program will start recording at the preset start time and the earlier program will not be recorded for the overlapping period.
- If the same start time is set on two or more programs, the lowest program number has priority over the other program numbers. The programmed data of the other program numbers will be erased when the timer recording starts.

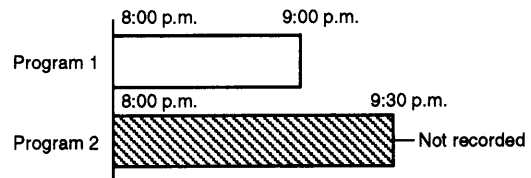
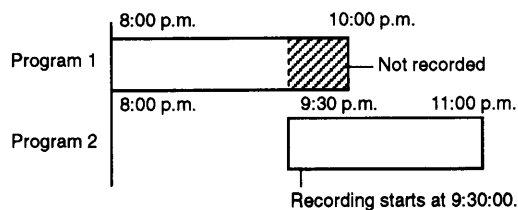

COPYING

Copyright

It is permissible to record television programs, film video tapes and other material only in the event that third party copyrights and other rights are not violated.

Copying VCR Recording

To copy all pictures and sounds of a prerecorded tape onto another tape.

Preparation

1. See below for how to connect the equipment.
2. Load the desired tape for copying into the **PLAYBACK VCR**.
3. Load a cassette with the safety tab into the **RECORDING VCR**.
4. Select "L" on the **RECORDING VCR** by pressing the **CHANNEL** Δ or ∇ button in channel selecting mode.

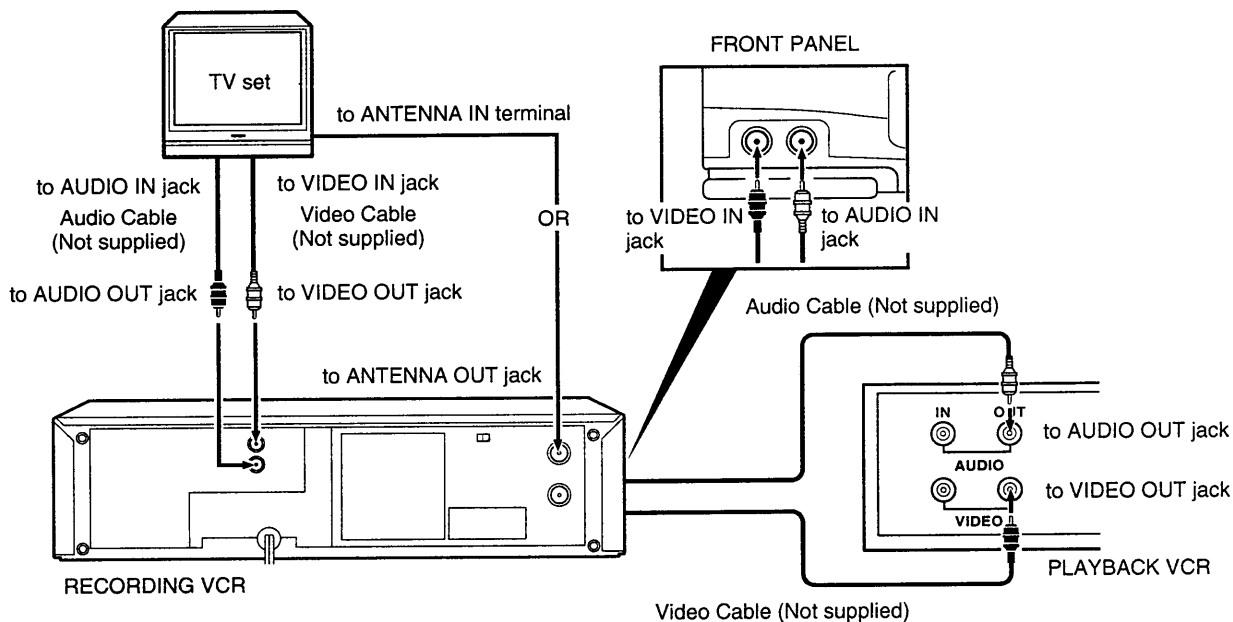

Operation

Procedure	RECORDING VCR	PLAYBACK VCR
①	Press the REC/OTR button then the PAUSE/STILL button (RECORDING PAUSE mode).	
②		Press the PLAY button.
③	Press the PAUSE/STILL button. Recording starts.	
④	Press the STOP button after copying is completed.	
⑤		Press the STOP button.

Note

In general, picture quality deteriorates somewhat in dubbing tapes. It is best to use SP mode.

SPECIALIZED OPERATIONS



OTHERS

Before Calling Service Personnel

Check the following list of problems and remedies before calling service personnel. The problem may be one you can solve yourself.

	PROBLEM	REMEDY
Power supply	• Power will not go on.	• The power cord may not be plugged in. Plug it firmly into the outlet.
	• Although the power is on, the VCR will not work.	• There is no cassette in the VCR. Load a cassette.
Clock/Timer	• The clock will not work.	• There has been a power failure. Reset the clock. (See page 20.)
	• The timer will not work.	• The clock time is incorrect. Adjust the clock to the correct time. (See page 20.)
TV Reception	• Picture does not appear on the TV screen.	<ul style="list-style-type: none"> • The TV channel must be set to the VCR output channel 3 or 4, or set the TV/VCR select switch on the TV to VCR. • Adjust antenna direction or use an optional antenna booster. • The power cord must be plugged into the outlet firmly. • Check connections between the TV and the VCR and connect them correctly.
Recording and Playback	• Picture does not appear on the TV screen during recording and playback.	• Make sure that "VCR" is selected in the multi-display and that the TV channel is set to 3 or 4.
	• The VCR will not record.	<ul style="list-style-type: none"> • The cassette's safety tab may be broken off. Use a cassette with a tab or cover the hole with adhesive tape. • The tape may have run out. Replace with another one with sufficient length.
	• The picture from the VCR tape is poor.	<ul style="list-style-type: none"> • Fine-tune the TV channel. • Adjust the TRACKING control on the remote control unit. • Clean the video heads of the VCR with a commercially available cleaning cassette tape. • The cassette tape may be old and/or defective. Replace with a new one.
	• The timer recording function will not work properly.	<ul style="list-style-type: none"> • There is an error in programming. Reprogram the preset information. • There must be a cassette in the VCR. • If the cassette does not have its safety tab, you must use another cassette or cover the hole with adhesive tape. • There has been a power failure. Reset the clock to the correct time if the time indication shows "12:00 AM". Reprogram the timer. (See page 35.) • More than one program has been preset within the same period. Reprogram the information. • The active channel is not tuned with the built-in tuner of the VCR. Select the channel on which the TV/CATV program is aired.
Remote Control	• The remote control will not work properly.	<ul style="list-style-type: none"> • Put new batteries into the unit if the old ones are exhausted. • Make sure batteries are inserted with the correct polarity. • Make sure that the remote control is within a 15° angle of the receptor on the VCR. • Use the remote control unit within 23 feet (7 m) from the VCR. • Remove any obstacle between the VCR and the remote control unit.
Miscellaneous	• The cassette is ejected immediately after it is loaded.	• Remove the cassette and reload it carefully.
	• The cassette will not go into the cassette compartment.	<ul style="list-style-type: none"> • The cassette was loaded immediately after pressing the EJECT button. Reload the cassette, waiting a moment after ejecting a cassette. • There is already a cassette in the VCR.
	• Correct indication does not appear in the multi-display.	• Clear the data stored in the unit's memory with the RESET button and input data again.

Specifications

Power supply:	120 V AC, 60 Hz
Power consumption:	17 W
External dimensions:	370 × 93 × 328 mm (W.H.D) (14-5/8 × 3-5/8 × 13 inches (W.H.D.))
Weight:	4.3 kg (9.5 lbs.)
Channels received:	VHF: Channels 1-13, UHF: Channels 14-69, CATV: Channels A7 - A1, A - CCC and 66 - 125
Antenna input/output terminals:	UHF/VHF: 75 Ω F type connector
Signal system:	Standard NTSC
Recording/Playback Cassette:	Recording:  VHS format (SP, SLP) Playback:  VHS format (SP, LP, SLP) Video cassette with VHS mark
Tape speed:	SLP: 1.11 cm/s., SP: 3.34 cm/s., LP: 1.67 cm/s.
Video record/playback time:	SLP: 480 min., LP: 320 min., SP: 160 min. (When T-160 video cassette is used)
Fast forward/rewind time:	Within 3 min. (when T-120 video cassette is used)
Video input:	1 V(p-p), 75 Ω, unbalanced, negative sync, pin jack
Video output:	1 V(p-p), 75 Ω, unbalanced, negative sync, pin jack
Audio input:	Line input: 308 mV (rms) more than 50 kΩ, pin jack
Audio output:	Line output: 308 mV (rms) less than 1 kΩ, pin jack
Audio frequency range:	80 Hz - 10 kHz
Utilization conditions:	Temperature: 40°F to 106°F (5 to 40°C) Operating Humidity: 35% to 80% RH
VHF output:	Channel 3 or 4
Time display:	12 hours digital display
Time precision:	Synchronized with the AC power frequency
Timer setting:	4 programs

Design and specifications are subject to change without notice.

LIMITED WARRANTY
TOSHIBA VIDEO CASSETTE RECORDER

Toshiba America Consumer Products, Inc. ("TACP") and Toshiba Hawaii Inc. ("THI") make the following limited warranties. These limited warranties extend to the original consumer purchaser or any person receiving this set as a gift from the original consumer purchaser and to no other purchaser or transferee.

Limited Ninety (90) Day Warranty

TACP and THI warrant this product against defects in materials or workmanship or a period of ninety (90) days after the date of original retail purchase. During this period TACP and THI will repair a defective product or part, without charge to you. You must deliver the entire product to a TACP/THI Service Center. You pay for all transportation and insurance charges for the set to and from the Service Center.

Limited One (1) Year Warranty

TACP and THI further warrant the parts in this product against defects in materials or workmanship for a period of one year after the date of original retail purchase. During this period, TACP and THI will replace a defective part without charge to you, except that if a defective part is replaced after ninety (90) days from the date of the original retail purchase you pay labor charges involved in the replacement. You must also deliver the entire product to one of the TACP/THI Service Centers. You pay for all transportation and insurance charges for the set to and from the Service Center.

Owner's Manual and Registration Card

You should read the owner's manual thoroughly before operating this product. You should also insure that your name and address are on file as owners of a TACP/THI product by completing and mailing the enclosed registration card within ten days after you, or the person who has given you this product as a gift, purchased this product. This is one way to enable TACP/THI to establish the date of purchase of the product, as well as to provide you with better customer service and improved products. Failure to return the card will not affect your rights. Under this warranty so long as you retain other proof of purchase such as a bill of sale.

Step-By-Step Procedures - How To Obtain Warranty Service

**IN THE CONTINENTAL
UNITED STATES...**

Should your unit require
service or parts, CALL



HAWAII
Toshiba Hawaii Inc.
Service Department
327 Kamakee Street
Honolulu, HI 96814
Phone Number:
(808) 521-5377

IN THE EVENT A PROBLEM SHOULD DEVELOP WITH YOUR PRODUCT, PLEASE PROCEED AS FOLLOWS:

- (1) Refer to the troubleshooting guide in your owner's manual. This check list may solve your problem.
- (2) Contact one of the TACP/THI Service Centers listed below for warranty service or call the TACP toll free number 1-800-631-3811 within thirty (30) days after you find a defective product or part.
- (3) Arrange for the delivery of the product to the Authorized TACP/THI Service Center. Products shipped to the Service Center must be insured

- and safely and securely packed, preferably in the original shipping carton, and a letter explaining the defect and also a copy of the bill of sale or other proof of purchase must be enclosed. All transportation and insurance charges must be prepaid by you. (See Packing and Shipping instructions on TOSHIBA SERVICE PROCEDURE.)
- (4) If you have any question about service, please contact one of the following TACP/THI Service Centers:

EAST

82 Totowa Road
Wayne, NJ 07470
Phone Number:
(201) 628-8000

SOUTHEAST

490 Armour Circle,
N. E.
Atlanta, GA 30324
Phone Number:
(404) 872-6955

MIDWEST

1010 Johnson Drive
Buffalo Grove, IL
60089
Phone Number:
(708) 541-9400

SOUTHWEST

1421 Champion Drive
Suite 304
Carrollton, TX 75006
Phone Number:
(214) 243-1367

WEST

5490E, Francis Street,
Ontario, CA 91761
Phone Number:
(909) 988-5303

IMPORTANT: PACKING AND SHIPPING INSTRUCTIONS

When you send the product to a service center, you must use the original carton box and packing material, then insert the original carton box containing the unit into another carton, using more packing material.

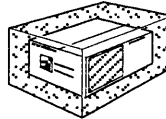

ALL WARRANTIES IMPLIED BY STATE LAW, INCLUDING THE IMPLIED WARRANTIES OF MERCHANTABILITY AND FITNESS FOR A PARTICULAR PURPOSE ARE EXPRESSLY LIMITED TO THE DURATION OF THE LIMITED WARRANTIES SET FORTH ABOVE. Some states do not allow limitations on how long an implied warranty lasts, so the above limitation may not apply to you. WITH THE EXCEPTION OF ANY WARRANTIES IMPLIED BY STATE LAW AS HEREBY LIMITED, THE FOREGOING EXPRESS WARRANTY IS EXCLUSIVE AND IN LIEU OF ALL OTHER WARRANTIES, GUARANTEES, AGREEMENTS AND SIMILAR OBLIGATIONS OF MANUFACTURER OR SELLER WITH RESPECT TO THE REPAIR OR REPLACEMENT OF ANY PRODUCT OR PARTS.

IN THE EVENT SHALL TACP OR THI BE LIABLE FOR CONSEQUENTIAL OR INCIDENTAL DAMAGES. Some states do not allow the exclusion or limitation of incidental or consequential damages so the above limitation may not apply to you.

No person, agent, distributor, dealer, service station or company is authorized to change, modify or extend the terms of these warranties in any manner whatsoever. The time within which an action must be commenced to enforce any obligation of TACP and THI arising under this warranty or under any statute or law of the United States or any state thereof, is here by limited to one year from the date you discover or should have discovered, the defect. This limitation does not apply to implied warranties arising under state law. Some states do not permit limitation of the time within which you may bring an action beyond the limits provided by state law so the above provision may not apply to you. This warranty gives you specific legal rights and you may also have other rights which vary from state to state.

TOSHIBA AMERICA CONSUMER PRODUCTS, INC.

Printed in Singapore