

TOSHIBA

OWNER'S MANUAL

Video Cassette Recorder

Hi-Fi **VHS**

M-653

INTRODUCTION 1

PREPARATION 8

PLAYBACK 15

RECORDING 18

ADDITIONAL
INFORMATION 23

SAFETY PRECAUTIONS

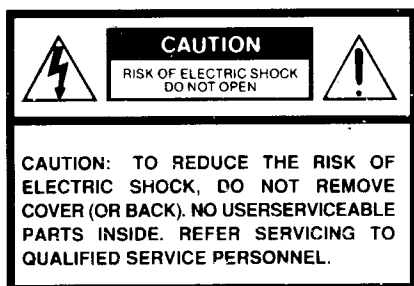

The lightning flash with arrowhead symbol, within an equilateral triangle, is intended to alert the user to the presence of uninsulated "dangerous voltage" within the product's enclosure that may be of sufficient magnitude to constitute a risk of electric shock to persons.



The exclamation point within an equilateral triangle is intended to alert the user to the presence of important operating and maintenance (servicing) instructions in the literature accompanying the appliance.

WARNING: TO REDUCE THE RISK OF FIRE OR ELECTRIC SHOCK, DO NOT EXPOSE THIS APPLIANCE TO RAIN OR MOISTURE. DANGEROUS HIGH VOLTAGES ARE PRESENT INSIDE THE ENCLOSURE. DO NOT OPEN THE CABINET. REFER SERVICING TO QUALIFIED PERSONNEL ONLY.

CAUTION: TO PREVENT ELECTRIC SHOCK, MATCH WIDE BLADE OF PLUG TO WIDE SLOT, FULLY INSERT.

USER-INSTALLER CAUTION: YOUR AUTHORITY TO OPERATE THIS FCC CERTIFIED EQUIPMENT COULD BE VOIDED IF YOU MAKE CHANGES OR MODIFICATIONS NOT EXPRESSLY APPROVED BY THIS PARTY RESPONSIBLE FOR COMPLIANCE TO PART 15 OF THE FCC RULES.

Note to CATV system installer:

This reminder is provided to call the CATV system installer's attention to Article 820-40 of the NEC that provides guidelines for proper grounding and, in particular, specifies that the cable ground shall be connected to the grounding system of the building, as close to the point of cable entry as practical.

Copyright

It is permissible to record television programs, film, video tapes and other material only in the event that third party copyrights and other rights are not violated.

IMPORTANT PRECAUTIONS

Save Original Packing Materials

The original shipping carton and packing materials will come in handy if you ever have to ship your VCR. For maximum protection, repack the set as it was originally packed at the factory.

Avoid Volatile Liquid

Do not use volatile liquids, such as an insect spray, near the unit.
Do not leave rubber or plastic products touching the unit for a long time. They will mar the finish.

Moisture Condensation

Never operate this unit immediately after moving it from a cold location to a warm location. When the VCR is exposed to such a change in temperature, moisture may condense on the cylinder inside, one of its most crucial internal parts. To prevent the VCR from possible damage, do not use the unit for at least 2 hours when there is an extreme or sudden change in temperature.

Compatibility

This video cassette recorder (VCR) is compatible with any other VCR bearing the **VHS** mark. HQ VHS equipment is also compatible with existing, non-HQ VHS equipment.

In the spaces provided below, record the Model and Serial No. located at the rear of your video cassette recorder.

Model No. _____ Serial No. _____

Retain this information for future reference.

IMPORTANT SAFETY INSTRUCTIONS

CAUTION: PLEASE READ AND OBSERVE ALL WARNINGS AND INSTRUCTIONS GIVEN IN THIS OWNER'S MANUAL AND THOSE MARKED ON THE UNIT. RETAIN THIS BOOKLET FOR FUTURE REFERENCE.

This set has been designed and manufactured to assure personal safety. Improper use can result in electric shock or fire hazard. The safeguards incorporated in this unit will protect you if you observe the following procedures for installation, use and servicing. This unit is fully transistorized and does not contain any parts that can be repaired by the user.

DO NOT REMOVE THE CABINET COVER, OR YOU MAY BE EXPOSED TO DANGEROUS VOLTAGE. REFER SERVICING TO QUALIFIED SERVICE PERSONNEL ONLY.

1. Read owner's manual

After unpacking this product, read the owner's manual carefully, and follow all the operating and other instructions.

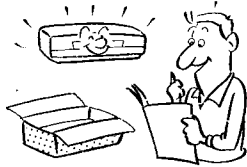

2. Power Sources

This product should be operated only from the type of power source indicated on the marking label. If you are not sure of the type of power supply to your home, consult your product dealer or local power company. For products intended to operate from battery power, or other sources, refer to the operating instructions.

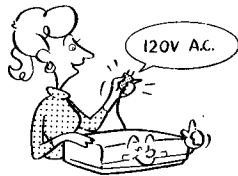

3. Grounding or Polarization

This product may be equipped with a polarized alternating current line plug (a plug having one blade wider than the other). This plug will fit into the power outlet only one way. This is a safety feature. If you are unable to insert the plug fully into the outlet, try reversing the plug. If the plug should still fail to fit, contact your electrician to replace your obsolete outlet. Do not defeat the safety purpose of the polarized plug.

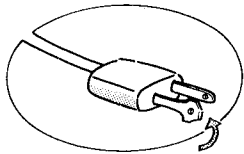

4. Ventilation

Slots and openings in the cabinet are provided for ventilation and to ensure reliable operation of the product and to protect it from overheating, and these openings must not be blocked or covered. The openings should never be blocked by placing the product on a bed, sofa, rug or other similar surface. This product should not be placed in a built-in installation such as a bookcase or rack unless proper ventilation is provided or the manufacturer's instructions have been adhered to.

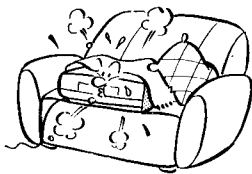

5. Heat

The product should be situated away from heat sources such as radiators, heat registers, stoves, or other products (including amplifiers) that produce heat.

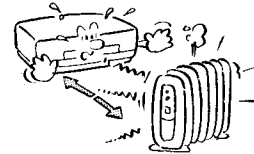

6. Water and Moisture

Do not use this product near water - for example, near a bath tub, wash bowl, kitchen sink, or laundry tub; in a wet basement; or near a swimming pool and the like.

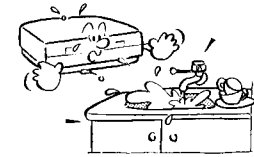

7. Cleaning

Unplug this product from the wall outlet before cleaning. Do not use liquid cleaners or aerosol cleaners. Use a damp cloth for cleaning.

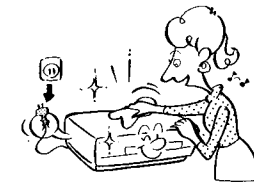

8. Power-Cord Protection

Power-supply cords should be routed so that they are not likely to be walked on or pinched by items placed upon or against them, paying particular attention to cords at plugs, convenience receptacles, and the point where they exit from the product.



9. Overloading

Do not overload wall outlets; extension cords, or integral convenience receptacles as this can result in a risk of fire or electric shock.

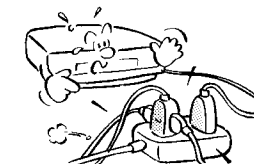

IMPORTANT SAFETY INSTRUCTIONS

10. Outdoor Antenna Grounding

If an outside antenna or cable system is connected to the product, be sure the antenna or cable system is grounded so as to provide some protection against voltage surges and built-up static charges. Article 810 of the National Electrical Code, ANSI/NFPA 70, provides information with regard to proper grounding of the mast and supporting structure, grounding of the lead-in wire to an antenna discharge unit, size of grounding conductors, location of antenna-discharge unit, connection to grounding electrodes, and requirements for the grounding electrode.

EXAMPLE OF ANTENNA GROUNDING AS PER NATIONAL ELECTRICAL CODE

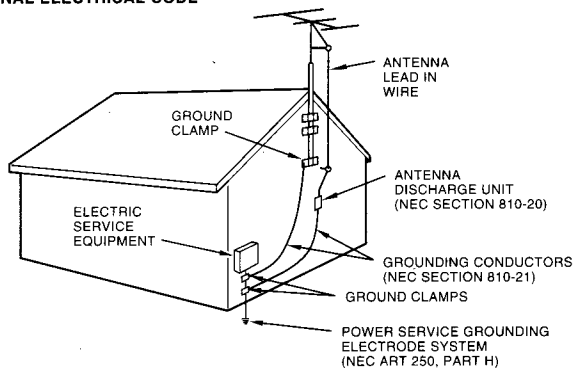

NEC - NATIONAL ELECTRICAL CODE

S2898A

11. Power Lines

An outside antenna system should not be located in the vicinity of overhead power lines or other electric light or power circuits, or where it can fall into such power lines or circuits. When installing an outside antenna system, extreme care should be taken to keep from touching such power lines or circuits as contact with them might be fatal.

12. Lightning

For added protection for this product during storm, or when it is left unattended and unused for long periods of time, unplug it from the wall outlet and disconnect the antenna or cable system. This will prevent damage to the product due to lightning and power-line surges.

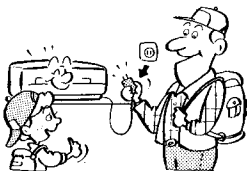

13. Object and Liquid Entry

Never push objects of any kind into this product through openings as they may touch dangerous voltage points or short-out parts that could result in a fire or electric shock. Never spill liquid of any kind on the product.

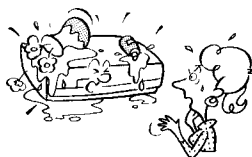

14. Attachments

Do not use attachments not recommended by the product manufacturer as they may cause hazards.

15. Accessories

Do not place this product on an unstable cart, stand, tripod, bracket, or table. The product may fall, causing serious injury to a child or adult, and serious damage to the product. Use only with a cart, stand, tripod, bracket, or table recommended by the manufacturer, or sold with the product. Any mounting of the product should follow the manufacturer's instructions, and should use a mounting accessory recommended by the manufacturer.



A product and cart combination should be moved with care. Quick stops, excessive force, and uneven surfaces may cause the product and cart combination to overturn.

16. Damage Requiring Service

Unplug this product from the wall outlet and refer servicing to qualified service personnel under the following conditions:

- When the power-supply cord or plug is damaged.
- If liquid has been spilled, or objects have fallen into the product.
- If the product has been exposed to rain or water.
- If the product does not operate normally by following the operating instructions. Adjust only those controls that are covered by the operating instructions as an improper adjustment of other controls may result in damage and will often require extensive work by a qualified technician to restore the product to its normal operation.
- If the product has been dropped or damaged in any way.
- When the product exhibits a distinct change in performance - this indicates a need for service.

17. Servicing

Do not attempt to service this product yourself as opening or removing covers may expose you to dangerous voltage or other hazards. Refer all servicing to qualified service personnel.

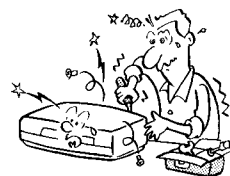

18. Replacement Parts

When replacement parts are required, be sure the service technician has used replacement parts specified by the manufacturer or have the same characteristics as the original part. Unauthorized substitutions may result in fire, electric shock, or other hazards.

19. Safety Check

Upon completion of any service or repairs to this product, ask the service technician to perform safety checks to determine that the product is in proper operating condition.

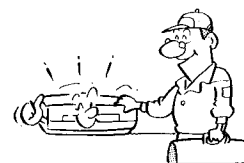

1 CONTENTS

1 INTRODUCTION

Provides important notes and general explanation of the VCR, including names of the buttons, jacks, etc.

SAFETY PRECAUTIONS	1
IMPORTANT PRECAUTIONS	1
IMPORTANT SAFETY INSTRUCTIONS	2
CONTENTS	4
For convenient use of this manual	5
IDENTIFICATION OF CONTROLS	6
• Front Panel	
• Remote Control	
• Rear Panel	
• VCR Display	

INTRODUCTION

2 PREPARATION

Explains what you need to do before operating the VCR.

HOW TO USE THE REMOTE CONTROL	8
CONNECTIONS	9
MULTI BRAND REMOTE CONTROL	11
INITIAL SETTINGS USING ON-SCREEN DISPLAY	12
• Setting the Language	
• Setting the Clock	
STORING CHANNELS ON THE VCR	13

PREPARATION

3 PLAYBACK

Explains variable functions concerning playback.

VIDEO CASSETTE USE	15
COUNTER FUNCTION	15
PLAYBACK	16
VARIABLE SPEED PLAYBACK	17
• Picture Search	
• Still Picture	
• Slow-motion Picture	

PLAYBACK

4 RECORDING

Explains recording functions.

RECORDING A TV PROGRAM	18
• Watching a TV Program While Recording Another	
TIMER PROGRAM RECORDING	19
MTS BROADCAST COMPATIBILITY	21
TAPE COPYING	22
SIMULCAST RECORDING	22

RECORDING

5 ADDITIONAL INFORMATION

BEFORE CALLING SERVICE PERSONNEL	23
SPECIFICATIONS	24
ACCESSORIES	24
LIMITED WARRANTY	Back page

ADDITIONAL INFORMATION

For convenient use of this manual

Fold out the leaf of this page.

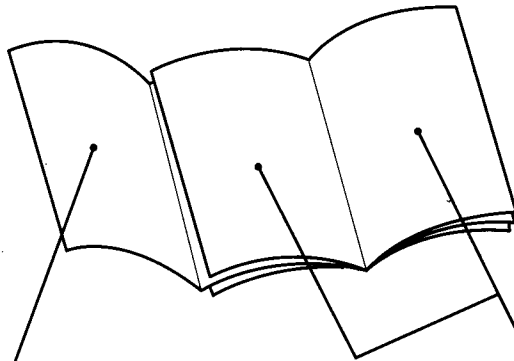

Each part has a number for identification, which is used also in the texts for reference. You can easily locate the parts using these numbers.

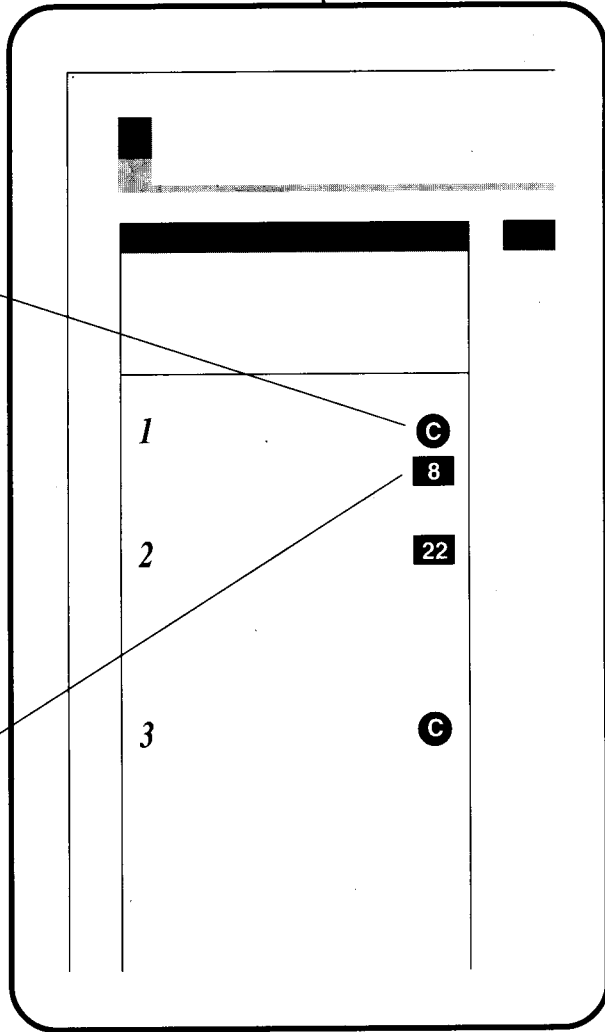
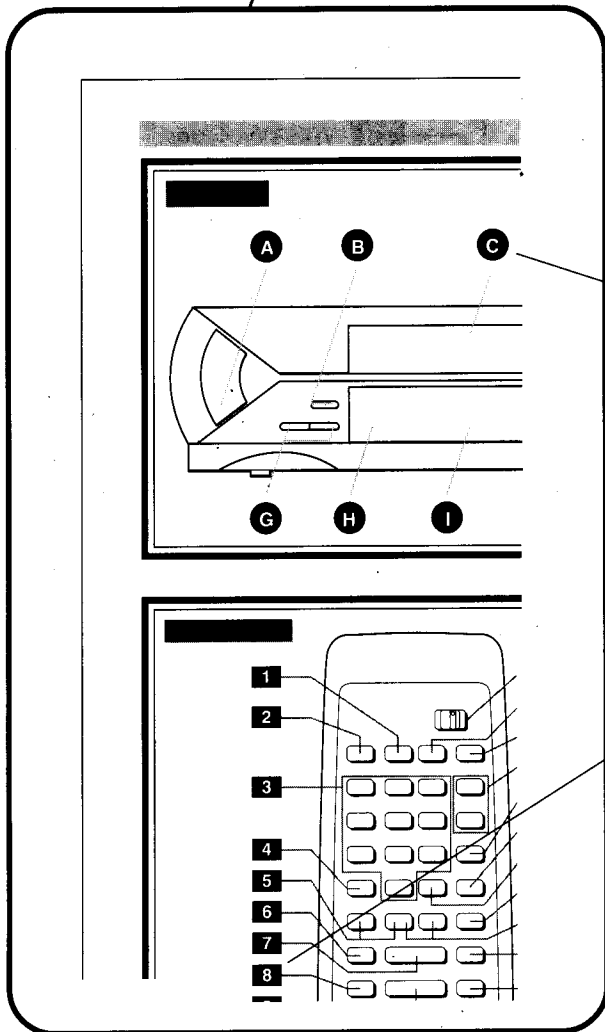

- Numbers in the circle refer to the parts on the front panel: those in the square to the remote control.

IDENTIFICATION OF CONTROLS

Front Panel

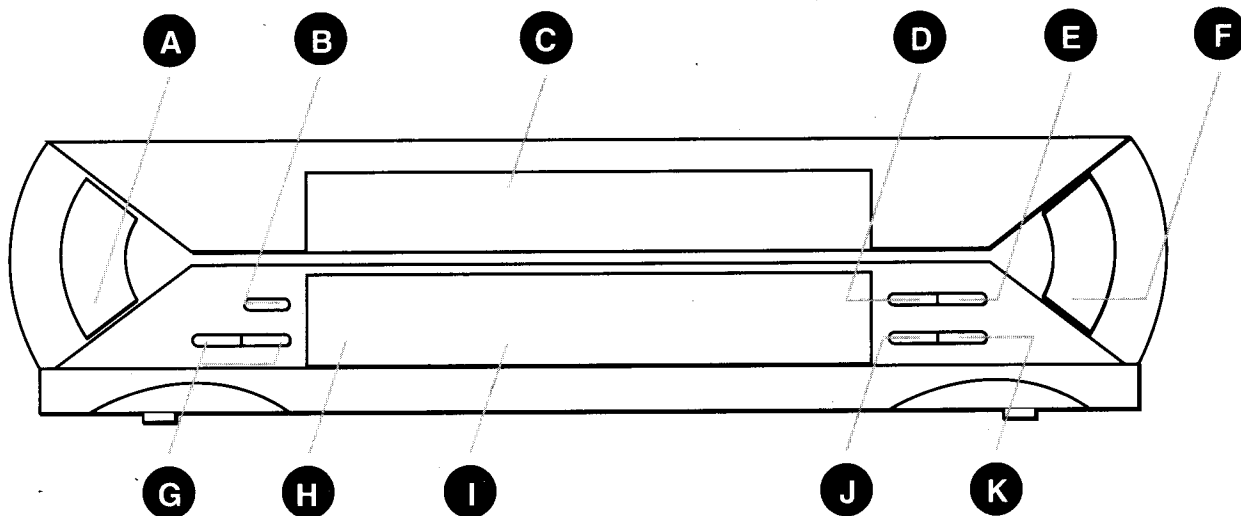

Remote Control

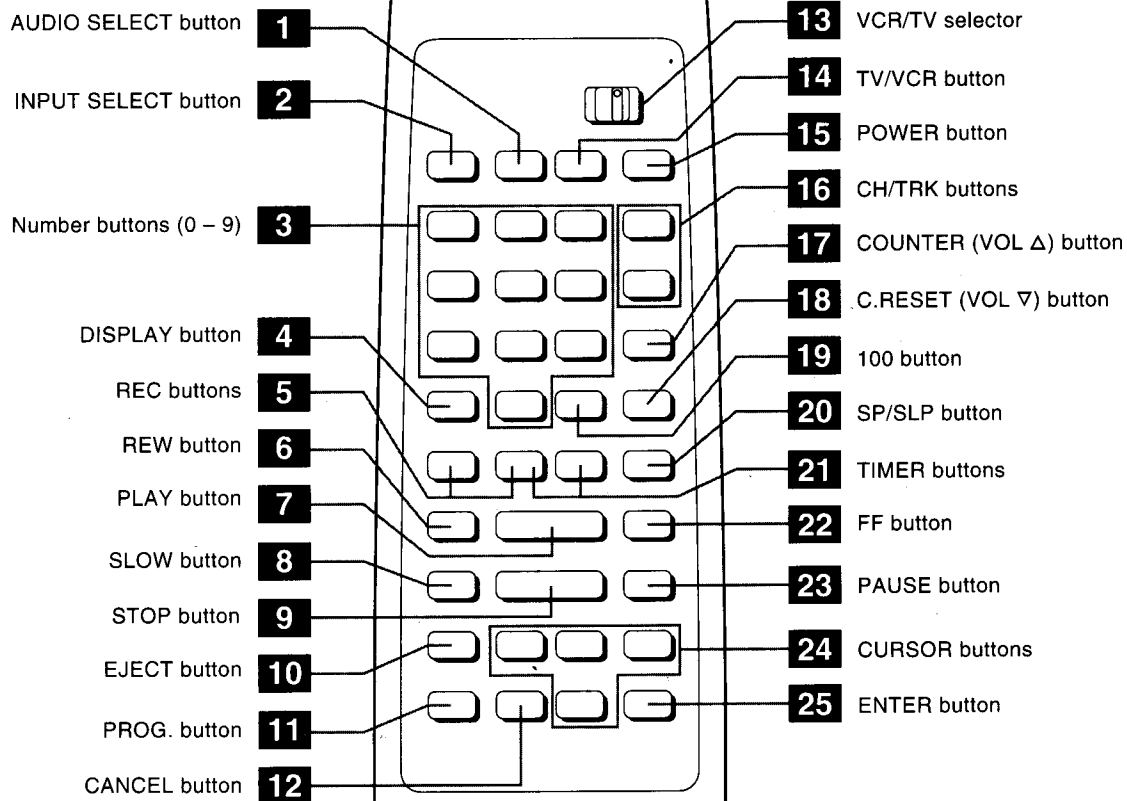

- A** POWER button
- B** REC (Record) button
- C** Cassette compartment
- D** PLAY button
- E** STOP button
- F** EJECT button
- G** CHANNEL buttons
- H** Remote sensor
- I** VCR display
- J** REW (Rewind) button
- K** FF (Fast Forward) button

LINE IN 1 AUDIO (Rear) jacks

If the connected equipment is monaural (has one audio output jack), connect the L (MONO) side, the same sound is recorded on both L and R on the Hi-Fi track.

Rear Panel

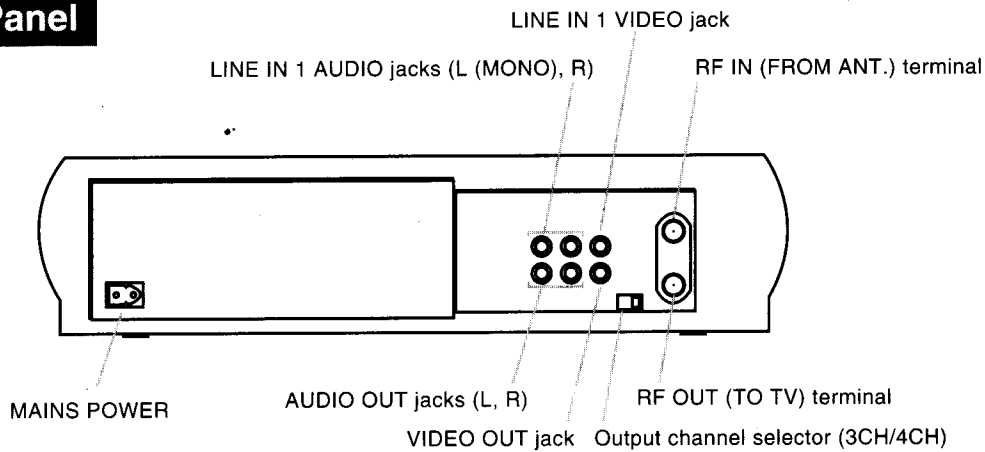

VCR Display

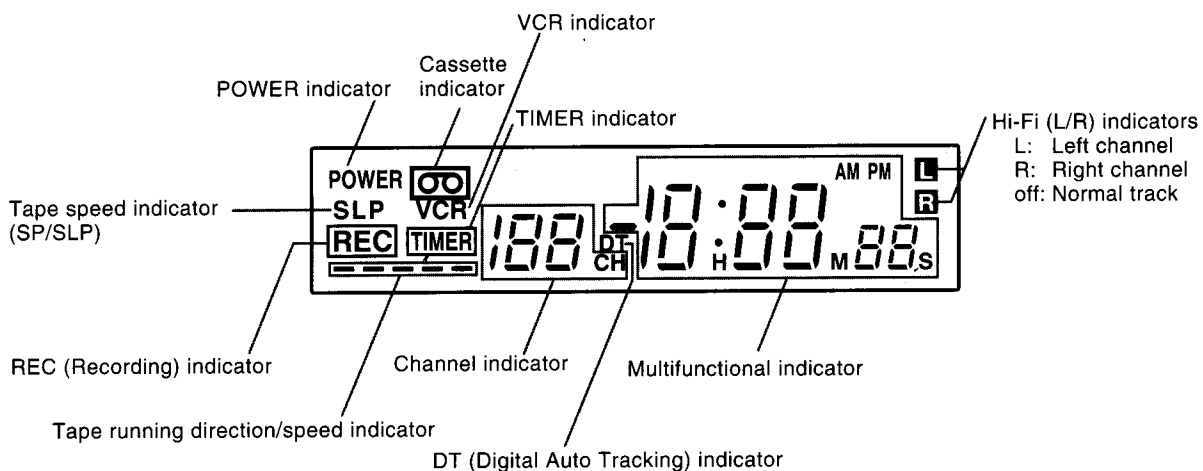

2 HOW TO USE THE REMOTE CONTROL

This section explains how to get ready for remote control operation.

Setting up the Remote Control

- 1** Open the battery compartment lid on the rear panel.

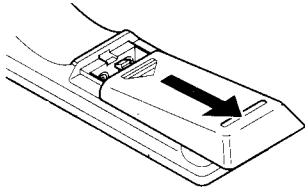

- 2** Install 2 batteries ("AA" size) following the polarity diagrams.

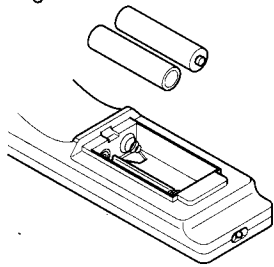

- 3** Close the battery compartment lid.

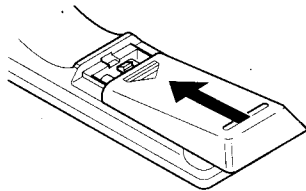

- 4** Point the remote control at the VCR and press the buttons within the operating range as illustrated.

Distance: within about 7 m from the front of the remote sensor

Angles: within about 30° in every direction

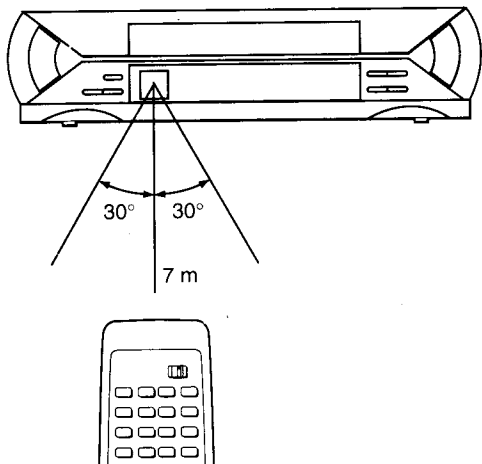

Notes on Batteries

- The life of the batteries is about 1 year depending on the conditions of use.
- If the remote control does not operate correctly, replace all batteries with new ones.
- Do not dispose of the batteries by fire.
- If the remote control is not to be used for a long period of time, remove the batteries to avoid possible damage from battery corrosion.

Caring for the Remote Control

- When using the remote control, press the buttons at intervals of about 1 second to ensure the correct mode of operation.
- Keep the remote control away from extremely hot or humid places and avoid sharp impacts.
- Do not expose the remote sensor of the VCR to a strong light source such as direct sunlight or illumination (especially high-frequency lighting) when using the remote control.
- Be careful not to spill water on the remote control or to place it on anything wet.

PREPARATION

Before you use this VCR, it is necessary to connect it to your TV. Several ways of connecting are available depending on your use of TV or cable box. Select one which is applicable to your equipment.

Antenna/VCR/TV Connection

- 1 Disconnect the antenna cable from your TV and connect it to the **RF IN** terminal on the VCR.
- 2 Connect the **RF OUT** terminal to the TV.

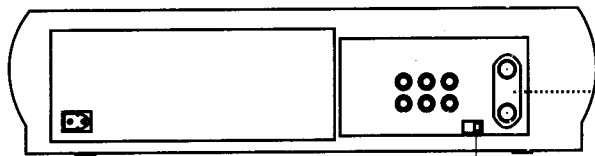
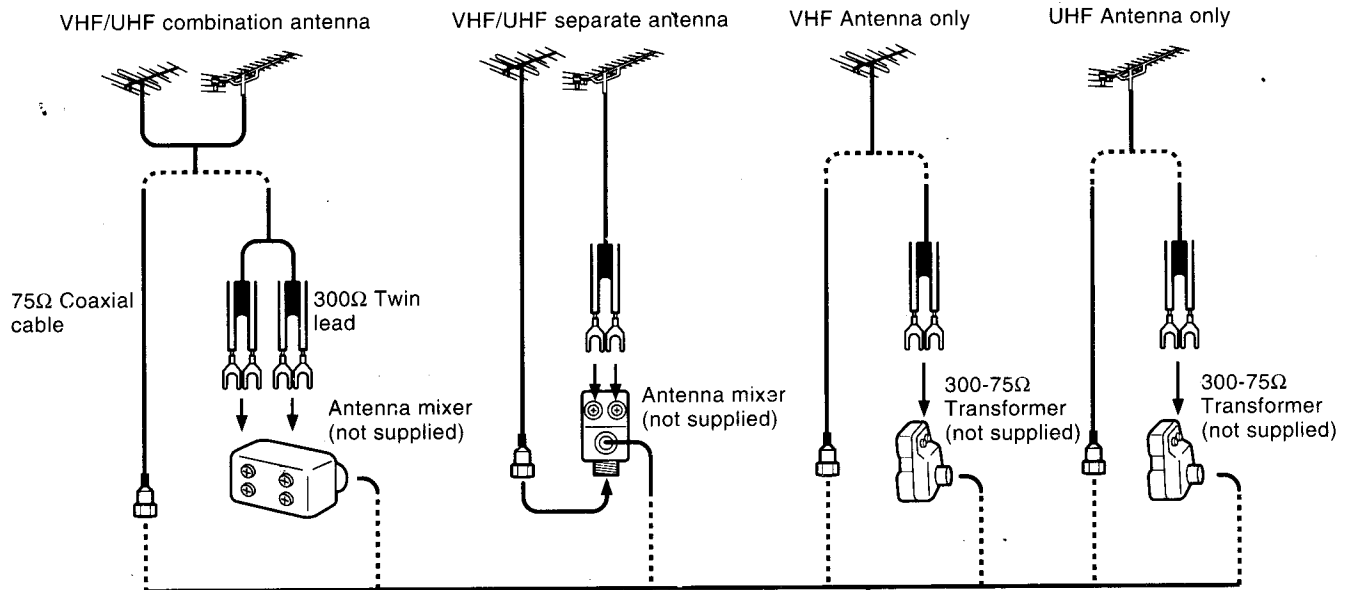

Apply the end attachments (not supplied) if necessary according to the diagram.

Setting the VCR Output Channel

When the VCR is connected in this way, the VCR sends the video signals to channel 3 or 4 on your TV. Set the output channel selector on the rear panel of the VCR to "3CH" or "4CH", whichever is vacant in your area, so that your TV can receive the signals. If you made the connection with the audio/video cable (on next page), you do not need to set this.

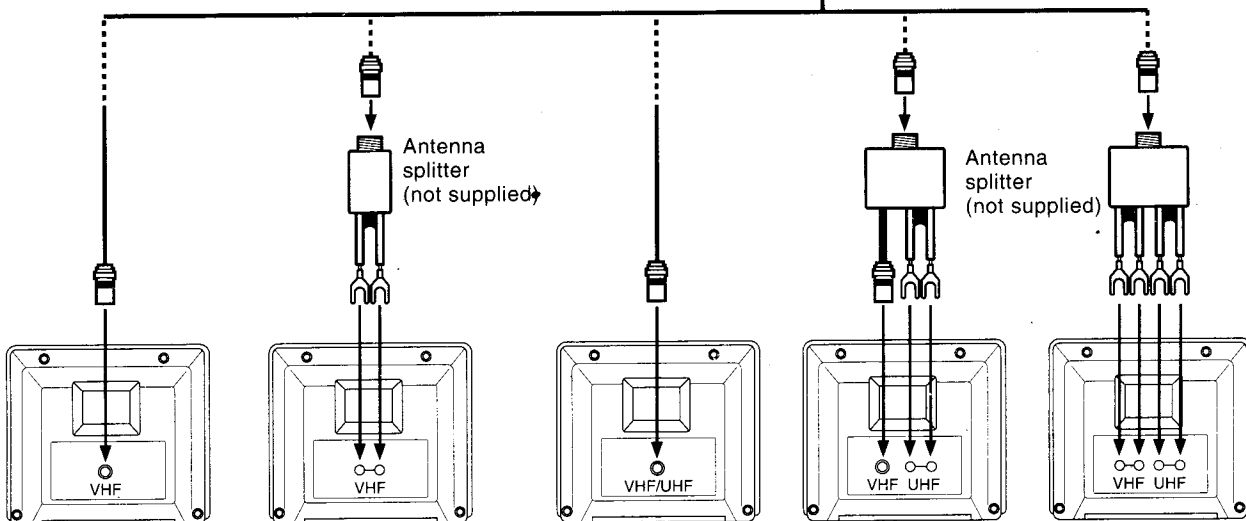

Cable Connection

Choose one of the below according to your usage of the cable box.

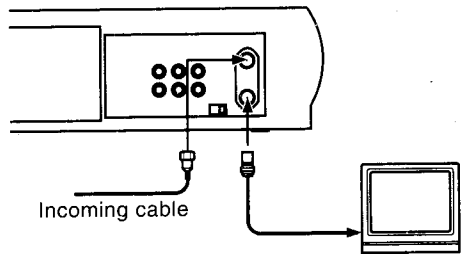

This set-up will enable you to:

- record an unscrambled channel.
- watch an unscrambled channel while recording it.
- record an unscrambled channel while watching another (only when you connect a cable-compatible TV).

You will need to:

- select TV channel 3 or 4 to receive video signals. (See page 9.)
- to record a channel while watching another, press the TV/VCR button on the remote control to turn off the "VCR" indicator in the VCR display and select a desired channel on the TV (only when you connect a cable-compatible TV).

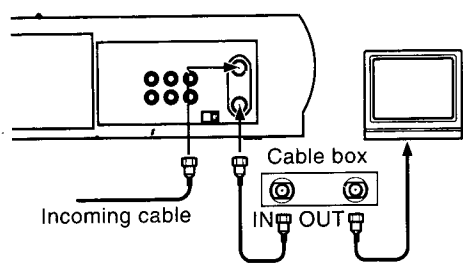

This set-up will enable you to:

- record an unscrambled channel.
- watch an unscrambled channel while recording it.
- record an unscrambled channel while watching another (scrambled or unscrambled).

You will need to:

- set TV channel to the output channel of the cable box.
- turn on the cable box and select cable channel 3 or 4 according to the output channel of the VCR.
- to record a channel while watching another, press the TV/VCR button on the remote control to turn off the "VCR" indicator in the VCR display and select a desired cable channel on the cable box.

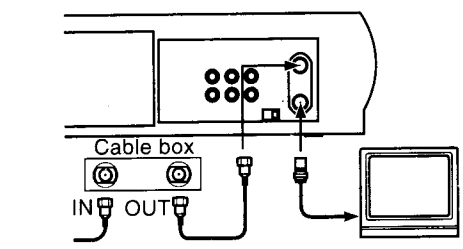

This set-up will enable you to:

- watch an unscrambled or scrambled channel while recording it.
- record any channels through the cable box.

You will need to:

- set TV channel 3 or 4 to receive video signals. (See page 9.)
- set VCR channel to the output channel of the cable box, and select a desired cable channel on the cable box.
- while the VCR is turned off or the "VCR" indicator is not lit in the VCR display, set TV channel to the output channel of the cable box.

Incoming cable

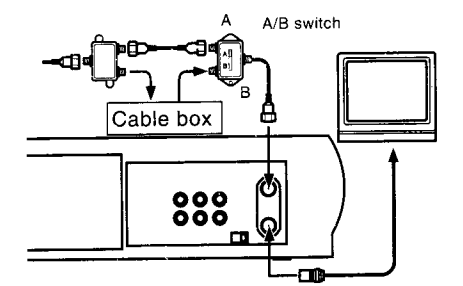

This set-up will enable you to:

- watch an unscrambled or scrambled channel while recording it.
- record an unscrambled channel while watching another unscrambled channel (only when you connect a cable-compatible TV).
- A/B switch "A": record and watch an unscrambled channel which comes bypassing the cable box.
- A/B switch "B": record and watch a scrambled or unscrambled channel coming through the cable box.

AUDIO/VIDEO Connections

The AUDIO/VIDEO jacks are also available to connect your TV or cable box.

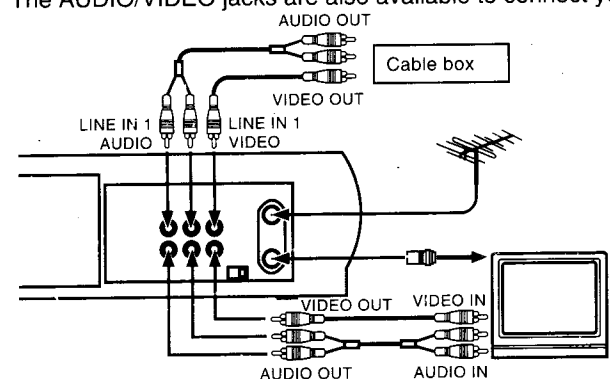

Connecting your cable box using the LINE IN 1 (AUDIO/VIDEO) jacks

To watch or record a channel via the connected cable box, press the INPUT SELECT button so that the VCR display shows "L". For details, see page 22.

Connecting your TV using the AUDIO/VIDEO OUT jacks

It is not necessary to set the output channel selector (3CH/4CH) on the VCR and TV channel 3 or 4. To watch video pictures, set the video input mode on your TV. For the video input mode, refer to the manual of your TV.

The remote control can be compatible with various brands of TV by setting their control codes. The TOSHIBA code has initially been set to control TOSHIBA TVs.

Setting Control Codes

Preparation

Set the VCR/TV selector to "TV".

13



1 While holding down the **PROG.** button, enter the two digits of your TV's brand code (listed right) using **number buttons**.

11

3

Hold down.



example



2 Release the **PROG.** button.

11

3 Point the remote control at your TV and use each button listed below to make sure that your TV is operated correctly.

POWER	To turn the TV on or off.	15
CH/TRK	To select TV channels in the upper or lower direction.	16
VOL Δ	To adjust the sound level.	17
VOL ∇		18
INPUT SELECT	To select an external source such as a VCR.	2
Number buttons	To select TV channels. When selecting channels 1 to 9, first enter 0 and then the desired number.	3
100	To substitute for 100 channel key.	19
DISPLAY	To turn on or off TV's screen display.	4
ENTER	To use for the TV's ENTER key.	25

Important

Some TVs may not respond to all the operations above, or may not be operated at all with this remote control. In this case, operate your TV with its own remote control.

Notes

- For some brands, several control codes (brand codes) are allocated. Try each of them until the buttons work on your TV.
- If you replace the remote control's batteries, set the brand code again.

Table of Brand Codes

Brand name of your TV	Brand code
Toshiba	01
Bell & Howell	09
Carver	10
Celebrity	03
Citizen	12
Curtis Mathes	09, 12
Dumont	14
Electro band	03
Emerson	09, 11
Fisher	09
GE	02, 07, 11
Gibraltar	14
Goldstar	11
Hallmark	11
Hitachi	06
Infinity	10
JBL	10
JCB	03
JVC	05
LXI	01, 02, 09, 10, 11
Magnavox	10
Marantz	10
Megatron	06, 11
Memorex	04, 09, 11
MGA	04, 11
Midland	02, 07, 14
Mitsubishi	04, 11
Motorola	08
MTC	12
NAD	01, 11
Nikko	11
Optimus	09
Optonica	08
Panasonic	07, 10, 15
Penney	01, 02, 07, 11, 12
Philco	10
Philips	10
Princeclub	12
Prism	07
Proscan	02
Proton	11
Pulser	14
Quasar	07, 15
Radio Shack	13, 18
RCA	02
Realistic	09, 11, 13
Runco (NEC)	14
Samsung	11, 12
Sanyo	09
Scotch	11
Scott	11
Sears	01, 02, 09, 10, 11
Sharp	08, 13
Sony	03
Soundesign	11
Supreme	03
Sylvania	10
Tandy	08
Technics	07, 15
Techwood	07
Teknika	04, 10, 12
TMK	11
Victor	05
Vidikron	10
Vidtech	11
Wards	10, 11, 13
Zenith	14

2 INITIAL SETTINGS USING ON-SCREEN DISPLAY

The VCR needs to be made the language selection and clock setting when first plugged in or encountered a power failure.

Setting the Language

Preparation

- Turn on the TV, and select the video channel (3 or 4), or the video input mode if you made the Audio/Video connection (page 10).
- Set the VCR/TV selector to "VCR".

- 1** Press the **POWER** button to turn on the VCR. 15



- 2** Press the **PROG.** button. 11
The following screen appears on the TV.

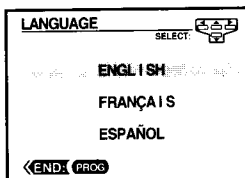

- 3** Select the language using the **CURSOR** ▲ or ▼ button, and press the **PROG.** button. 24
The screen turns to the MENU screen. 11

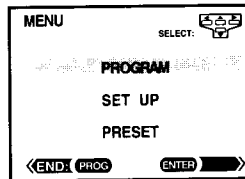
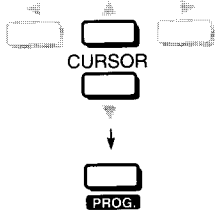

How to move around on the screen

The four buttons control a cursor (a value) on the screen in the respective directions. 24

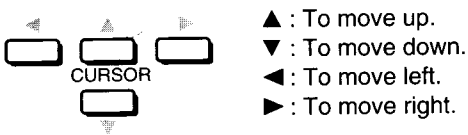

Press the **PROG.** button to return to the normal TV screen. 11

Setting the Clock

Example To set the clock to 2:30 p.m. on Monday.

- 1** Press the **PROG.** button. 11
The MENU screen appears on the TV.

- 2** Select "PRESET" using the **CURSOR** ▲ or ▼ button, and press the **ENTER** button. 24
25

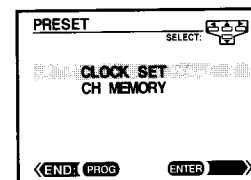
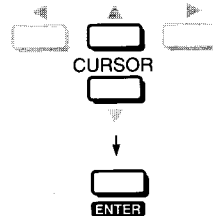

- 3** Press the **ENTER** button to select "CLOCK SET". 25

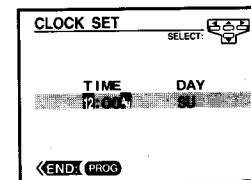

- 4** Move to the next using the **CURSOR** ► button. 24
(To move back, press the **CURSOR** ◀ button.)

- 5** Vary the digits to set the hour. 24

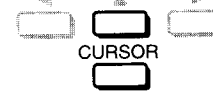

CURSOR ▲: To increase.
CURSOR ▼: To decrease.

- 6** Repeat steps 4 and 5 to set the minutes and the day.

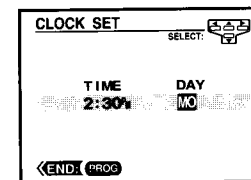

- 7** Press the **PROG.** button. 11
Now the clock starts.

- 8** Press the **PROG.** button twice to exit. 11

PREPARATION

Optional Settings on the SET UP Screen

Other optional settings can be made. Press the **ENTER** button while "SET UP" is selected on the MENU screen. The screen turns to the SET UP screen.

24

25

Page 21
Page 22

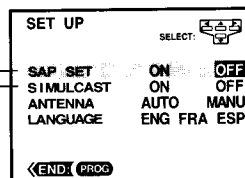

With "AUTO" set, a TV broadcast will appear via the TV tuner after playback. Move down here, and set to "AUTO" or "MANU". 24
If you made the Audio/Video connection (page 10), set to "MANU".

To exit, press the **PROG.** button twice. 11

To change the language, move down here and set to the desired one. 24

STORING CHANNELS ON THE VCR

This section is required if you receive only normal TV or unscrambled cable channels, or use a cable box between your TV and the VCR.

Automatic TV/CATV Channel Scanning

The VCR scans through all receivable TV and CATV channels and stores only the active ones in your area into the memory. Once the storing is finished, you can select a desired channel by using the CH/TRK buttons. 16

Preparation

- Turn on the TV, and select the video channel (3 or 4), or the video input mode if you made the Audio/Video connection (page 10). 13
- Set the VCR/TV selector to "VCR".
- Turn on the VCR.

TV Channel Scanning

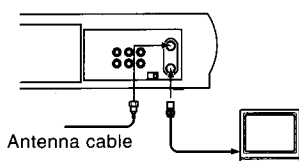

1 Press the **PROG.** button to display the MENU screen. 11

2 Select "PRESET" using the **CURSOR** ▲ or ▼ button, and press the **ENTER** button. 24
25

3 Select "CH MEMORY" using the **CURSOR** ▲ or ▼ button, and press the **ENTER** button. 24
25

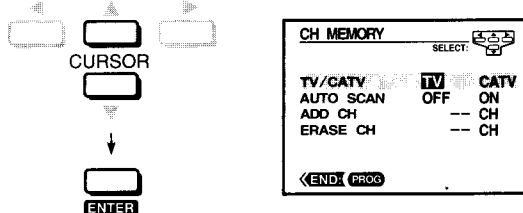

4 Make sure "TV/CATV" is set to "TV". (If it does not, set to "TV" with the **CURSOR** ◀ button.) 24

5 Select "AUTO SCAN" using the **CURSOR** ▲ or ▼ button, and press the ▶ button to set to "ON". 24

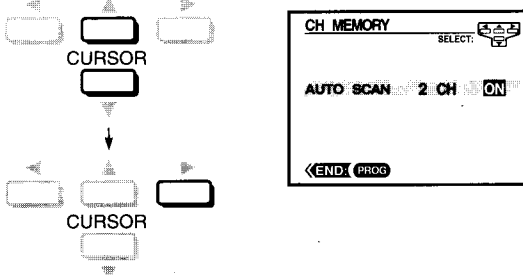

The VCR starts scanning and the channels are stored in the VCR in ascending order. When the scanning is finished, the screen automatically returns.

6 Press the **PROG.** button three times to exit. 11

CATV Channel Scanning

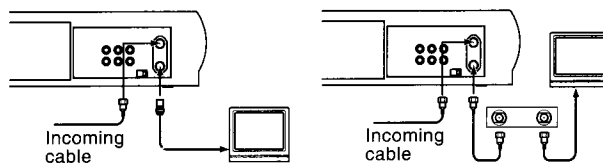

1 Press the **PROG.** button to display the MENU screen. 11

2 Select "PRESET" using the **CURSOR** ▲ or ▼ button, and press the **ENTER** button. 24
25

3 Select "CH MEMORY" using the **CURSOR** ▲ or ▼ button, and press the **ENTER** button. 24
25

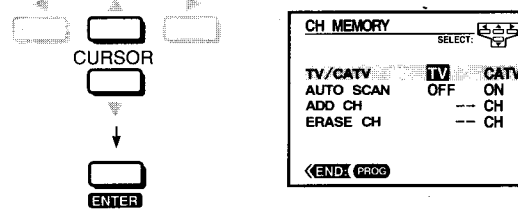

4 Set "TV/CATV" to "CATV" using the **CURSOR** ▶ button. 24

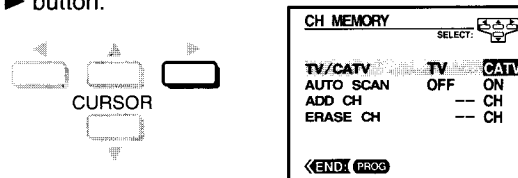

5 Select "AUTO SCAN" using the **CURSOR** ▲ or ▼ button, and press the ▶ button to set to "ON". 24

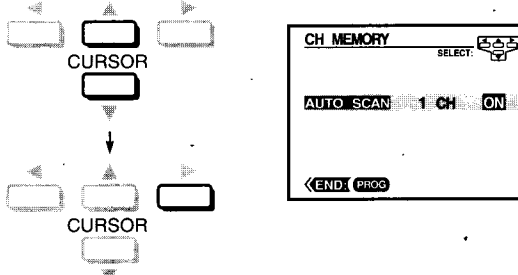

The VCR starts scanning and the channels are stored in the VCR in ascending order. When the scanning is finished, the screen automatically returns.

6 Press the **PROG.** button three times to exit. 11

Selecting Stored Channels

Once the active channels have been stored, you can select the channels in two ways below.

Number buttons: To enter digits of the channel number. **3**

- For one-digit number, enter 0 before. **19**
- For more than 100 number, first press the **100** button.
- Each number button needs to be pressed within 2 seconds.

CH/TRK buttons: To shift up or down the stored channel numbers. **16**

Adding or Erasing Channels

Adding channels

If a desired channel cannot be scanned automatically because of a weak signal, it can be added to the memory.

Erasing channels

You can erase a stored channel from the memory if it is unnecessary.

- 1) Follow steps 1 to 3 of "Automatic TV Channel Scanning" or "Automatic CATV Channel Scanning".

- 2) Select "ADD CH" or "ERASE CH" using the **CURSOR ▲** or **▼** button. **24**

To add channels

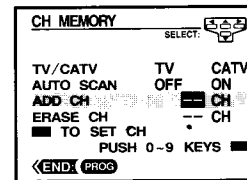

To erase channels

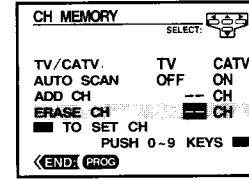

- 3) Enter a channel number of 1 to 125 by using **number buttons**. **3**

For more than 100 number, first press the **100** button. **19**

For CATV channels, refer to the chart below. (For other orders, check with your cable company.)

- 4) Repeat steps 2) and 3) above to add or erase channels as necessary.

- 5) Press the **PROG.** button three times to exit. **11**

PREPARATION

Channel Reference Chart

Number on the VCR		1	2	3	4	5	6	7	8	9	10	11	12	13	14	15	16	17	18										
Corresponding channel number		TV	CATV	STD	(HRC/IRC)	1(A-8)	2	3	4	5(A-7)	6(A-6)	7	8	9	10	11	12	13	14	15	16	17	18						
19	20	21	22	23	24	25	26	27	28	29	30	31	32	33	34	35	36	37	38	39	40	41	42	43	44	45	46	47	48
F	G	H	I	J	K	L	M	N	O	P	Q	R	S	T	U	V	W	AA	BB	CC	DD	EE	FF	GG	HH	II	JJ	KK	LL
49	50	51	52	53	54	55	56	57	58	59	60	61	62	63	64	65	66	67	68	69	70	71	...	93	94	95	96	97	98
MM	NN	OO	PP	QQ	RR	SS	TT	UU	VV	WW	XX	YY	ZZ	AAA	BBB	65	66	67	68	69	70	71	...	93	94	A-5	A-4	A-3	A-2
99	100	101	102	103	...	121	122	123	124	125																			
A-1	100	101	102	103	...	121	122	123	124	125																			

CATV signals

- STD (standard) cable TV signals
- HRC (Harmonic Related Carriers) cable TV signals
- IRC (Incremental Related Carriers) cable TV signals
- IRC is also called ICC (Incremental Coherent Carriers)

Video Cassette Use

■ Loading a Cassette

Push the cassette into the cassette compartment with the window side facing up and the label side towards the front. The VCR is automatically turned on. The  indicator will appear in the VCR display. C

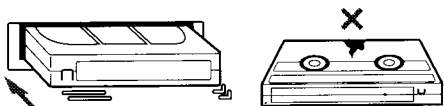

■ Ejecting a Cassette

Press the **EJECT** button. The cassette is ejected from the cassette compartment. F

10

Warning

Do not insert your hands or any foreign objects into the compartment. This may result in injury or damage. Take special care with children to avoid accidents.

Precautions When Using Video Cassettes

Video cassettes have a safety tab to prevent accidental erasure. If the tab has already removed, recording cannot be performed.

■ To prevent accidental erasure

Remove this safety tab with a screwdriver.

■ To record again

Cover the tab hole with adhesive tape.

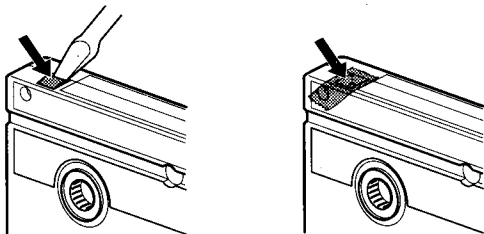

- Avoid exposing cassettes to direct sunlight. Keep them away from heaters. Avoid extreme humidity, vibrations or shock, strong magnetic fields (near a motor, transformer or magnet) and dusty place.

Counter Function

You can view the clock or linear time counter in the VCR display or on the TV screen.

Preparation

Set the VCR/TV selector to "VCR". 13

Counter Displays

Each time you press the **COUNTER** button, the VCR display changes in sequence as follows: 17

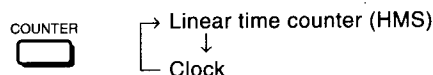

The indication above will also appear on the TV screen by pressing the **DISPLAY** button. They are switchable with the **COUNTER** button. 4

17

To reset the linear time counter to "0H00M00S"

The counter is automatically reset to "0H00M00S" when a cassette is ejected. If you want to reset at another point, such as the beginning of a new recording, just press the **C. RESET** button. 18

Notes

- The linear time counter does not work on non-recorded portions on the tape.
- When the tape is ejected or the VCR is turned off, the display changes to clock.
- If the tape rewinds back over "0H00M00S", "-" appears in the VCR display.
- The displayed time of the linear time counter is only an approximation.

3 PLAYBACK

This section explains the basic playback operation.

Basic Playback

Preparation

- Select the video channel (3 or 4) or video input mode on the TV.
- Set the VCR/TV selector to "VCR".

13

1 Load a recorded cassette. Power is turned on. If the cassette has no safety tab, playback starts automatically. **C**

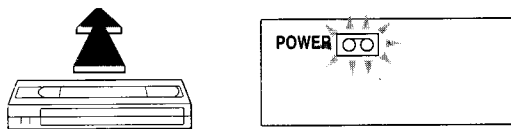

2 Press the **PLAY** button to start playback. **7 D**



3 To stop playback, press the **STOP** button. **9 E**



Rewinding/Fast-forwarding

To rewind or fast-forward the tape, press the **REW** or **FF** button in the stop mode as follows. **6 22**

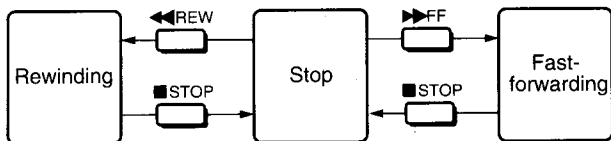

You can view pictures at various tape speeds. See page 17.

Adjusting the Tracking

Digital Auto Tracking

When playback starts, the VCR automatically adjusts the tracking for clear pictures and sound. The "DT" indicator blinks during the adjusting.

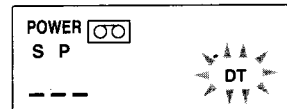

Notes

- During the adjusting, the playback picture and sound may be distorted.
- The digital auto tracking is activated only in the playback mode.

Adjusting the tracking manually

If the VCR cannot locate the best possible tracking point, hold down one of the **CH/TRK** button until you obtain the best possible picture and sound. **16**



Notes

- To reset the tracking point to the center, press both the CHANNEL buttons on the VCR simultaneously for no longer than 1 second. **G**
- To resume the digital auto tracking, hold down both the CHANNEL buttons on the VCR simultaneously for about 2 seconds. **G**
- The noise on the screen may not be completely eliminated depending on the tape used, especially when the tape was recorded on another VCR.

You can play back a tape at various tape speeds.

Variable Speed Playback

A variety of tape speeds are available on this VCR.

Picture search: Plays back at 5 times the normal playback speed so that you can quickly locate a particular scene.

Still picture: Freezes the picture so that you can watch closer.

Slow-motion picture: Plays back at 1/7th the normal playback speed.

Picture Search

While playing back a tape, press the **FF** or **REW** button.
The tape runs at 5 times the normal playback speed.

22
6

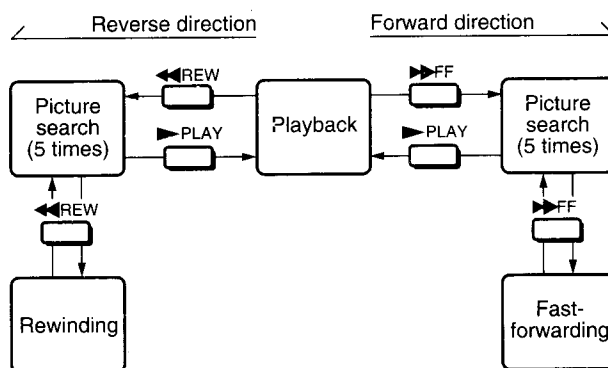

Still Picture

While playing back a tape, press the **PAUSE** button.
The picture freezes.

23

Slow-motion Picture

While playing back a tape, press the **SLOW** button.
The tape runs at about 1/7th the normal playback speed.

8

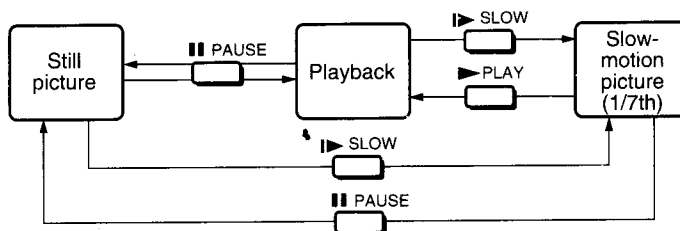

Notes

- The still mode is automatically cancelled after about 5 minutes and returns to normal playback.
- The still picture may shake if a picture of a fast-moving object or scene is frozen. This is not a defect in the unit.

■ Adjusting Still Picture Stability

If the still picture is distorted or flickers, hold down one of the **CH/TRK** buttons until the picture becomes stable.

16



Note

The distortion of the still picture may not be eliminated completely.

Notes

- The slow-motion picture mode is automatically cancelled after about 5 minutes and returns to normal playback.
- The slow-motion picture may flicker up and down. This is not a defect in the unit.

■ Adjusting the Tracking Manually

If the slow-motion picture is noisy, hold down one of the **CH/TRK** buttons until the best picture is obtained.

16



Note

The noise in the slow-motion picture may not be eliminated completely.



Note

If you play back a tape recorded in the SLP tape speed or a tape recorded on another VCR in various speed mode, the picture may be noisy or monochrome.

4 RECORDING A TV PROGRAM

This section explains the basic recording operation.

Basic Recording

Preparation

- Turn on the VCR.
- Select the video channel (3 or 4) or video input mode on the TV.
- Set the VCR/TV selector to "VCR".

13

1 Load a cassette with the safety tab attached. **C**

2 Press the **TV/VCR** button so that the "VCR" indicator appears in the VCR display. **14**

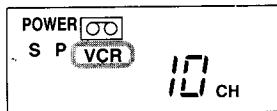

3 Select a channel to record with the **CHANNEL** buttons on the VCR, or the **CH/TRK** or **number buttons** on the remote control. **G 16**



If you see "L" in the VCR display, press the **INPUT SELECT** button so that the channel number appears. **2**

- If you record cable channels via the cable box, make the output channel number of the cable box or "L" appear, depending on your connection. (See page 10.)

4 Press the **SP/SLP** button to select the recording tape speed. **20**

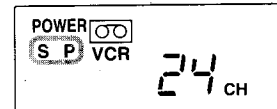

SP: Suitable for general recording with better picture and sound quality.

SLP: Suitable for tripling recording time, but with less picture and sound quality than using the SP tape speed.

5 Press the **REC** button on the VCR, or simultaneously press the two **REC** buttons on the remote control. Recording starts. **B 5**

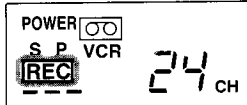

6 Press the **STOP** button to stop recording. **9 E**

Watching a TV Program While Recording Another

1) While recording, press the **TV/VCR** button so that the "VCR" indicator disappears in the VCR display. **14**

2) Choose another channel using the channel selector on the TV.

Note

To monitor the program which is being recorded, press the TV/VCR button so that the "VCR" indicator will appear in the VCR display. Select the video channel or video input mode on the TV. **14**

Skipping Unnecessary Scenes While Recording

Press the **PAUSE** button to stop recording momentarily. To resume recording, press the **PAUSE** button again. **23**

Note

The VCR automatically shifts to the stop mode if the recording pause mode continues for 10 minutes.

The programmable timer allows you to record up to 4 different programs over 2 weeks.

Timer Programming Procedure

Preparation

- Turn on the VCR.
- Select the video channel (3 or 4) or video input mode on the TV.
- Make sure that the clock is set correctly. (See page 12.)
- Select TV or CATV mode. (See pages 13 and 14.)
- Set the VCR/TV selector to "VCR".
- If you record cable channels via the cable box, keep the cable box turned on and select a channel to record on the cable box.

13

Example: To record cable channel 25 in the SP tape speed from 9:30 p.m. until 10:00 p.m. on this Saturday. Today is Monday.

1 Load a cassette with the safety tab attached. C

2 Press the **PROG.** button to display the MENU screen. 11

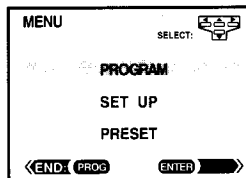

3 Select "PROGRAM" using the **CURSOR** ▲ or ▼ button, and press the **ENTER** button. 24
25

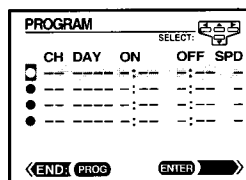
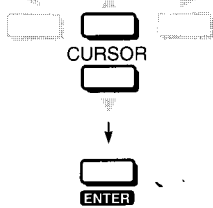

4 Move to the next using the **CURSOR** ► button, and enter the channel number 2 and 5 by **number buttons** or ▲ or ▼ button. 24
3

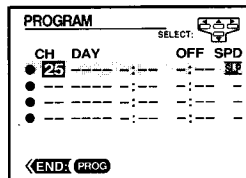
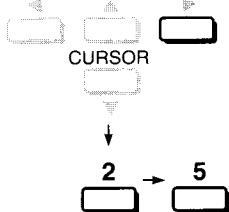

When entering more than 100 channel numbers, press the **100** button and enter the rest two digits. 19

If you use the cable box, enter the output channel number of the cable box with **number buttons** or make "L" appear by pressing the **INPUT SELECT** button, depending on your connection. (See page 10.) 3
2

To make corrections:

Press the **CURSOR** ◀ button to move back to the item, or the ► button to forward. 24

5 Move to the next using the **CURSOR** ► button, and set the recording date using the ▲ or ▼ button. 24

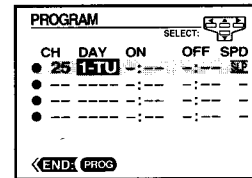
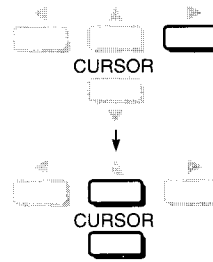

Note

The date changes as follows if it is Monday today:

1-MO→1-TU·1-SU→2-MO·2-SU→WKLYMO·WKLYSU→MO~FR

[1-MO]...[1-SU]:

You can record TV programs on the specified days for the following 7 days.

[2-MO]...[2-SU]:

You can record TV programs on the specified days for the following 7 days after 1 week later

[WKLYSU]...[WKLYSA]:

You can record TV programs on the same channel on the day and time every week.

[MO~FR]:

You can record TV programs on the same channel at the same time Monday through Friday.

6 Move to the next using the **CURSOR** ► button, and set the hour and minutes of the recording start time using the ▲ or ▼ button. 24

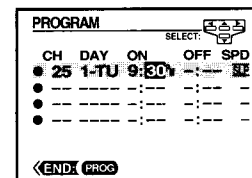
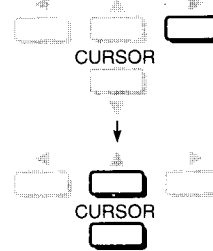

7 Move to the next, and set the recording off time. 24

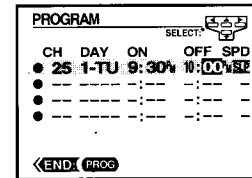
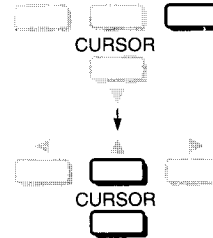

8 Move to the next, and select the tape speed (SP) using the **CURSOR** ▲ or ▼ button. 24

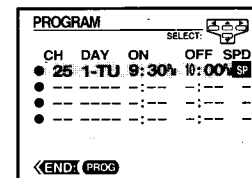
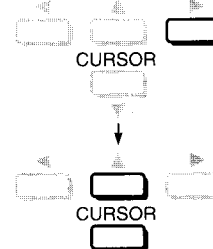

To set another program, press the **CURSOR** ◀ button, and select the next line pressing the ▼ button. Repeat steps 4 to 8. 24

- 9 Press the **PROG.** button.
Now programming is complete.

11



- 10 Press the two **TIMER** buttons simultaneously.

21



The power turns off and the VCR enters the timer standby mode.

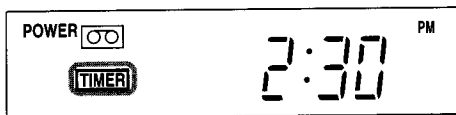

Confirming the Timer Programs (In the Timer Standby Mode)

- Press the **PROG.** button.
The screen for confirming will appear.

11

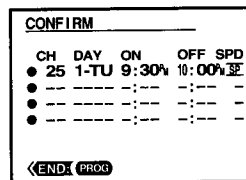

After about 30 seconds, the screen disappears.

Changing/Canceling the Timer Programs

- 1) If the **TIMER** indicator is lit, press the two **TIMER** buttons to turn it off, and then turn the VCR on by pressing the **POWER** button. 21
15
- 2) With steps 2 to 9, change the items.
 - To cancel a program, select the program you want to cancel after step 3, and press the **CANCEL** button. The line is then cleared. 12
- 3) Press the two **TIMER** buttons to return to the timer standby mode. 21

Recording or Playback in the Timer Standby Mode

First press the two **TIMER** buttons to release the timer standby mode, and then press the **POWER** button to turn on the VCR. The VCR will be available for use.

21
15

- Be sure to press the two **TIMER** buttons again to return the VCR to the timer standby mode after you are finished. 21

Error Indication

- The "E" (Error) indicator appears in the VCR display if you press the **TIMER** buttons when:
 - a cassette is not loaded.
 - the loaded cassette has no safety tab.
 - no timer program is set.
 In these cases, a recording can not be made.

If a power failure occurs during the timer program recording

- When a power failure has occurred, "12:00AM" blinks in the VCR display. Since the programmed contents have been cleared, reset the clock and timer programming.
- When power has failed for a short time, the colon of the current time display blinks. The programmed contents are not affected. Reset the clock.

Overlaps of the programs

If two timer programs overlap, the recording start time of program 2 has priority over the recording off time of program 1.

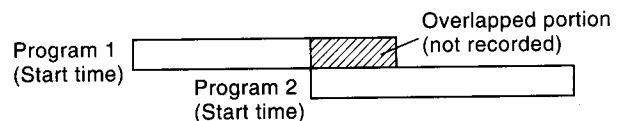

RECORDING

MTS BROADCAST COMPATIBILITY

This VCR can receive or record MTS (Multichannel TV Sound) broadcasts. By connecting the VCR to your stereo system or stereo TV, you will experience the SAP or stereo sound.

Recording the SAP/Stereo Broadcast

- Make sure that the VCR is connected to a mono TV and stereo system with speakers, or a stereo TV.

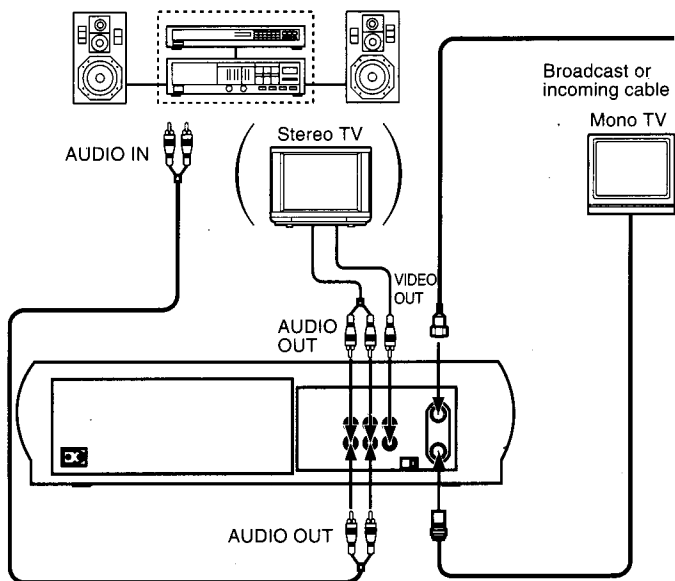

SAP (Second Audio Program broadcast):
A separate audio program, usually broadcast in a second language with the main language.

Preparation

Set the VCR/TV selector to "VCR".

13

1 Press the **PROG.** button to display the MENU screen.

11

2 Select "SET UP" using the **CURSOR** ▲ or ▼ button, and press the **ENTER** button.

24

25

3 Select "SAP SET" using the **CURSOR** ▲ or ▼ button, and set "SAP SET" to "ON" using the ◀ button.

24

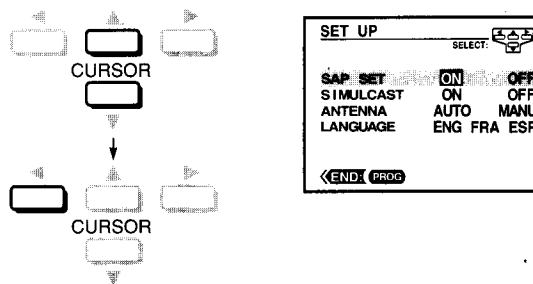

4 Press the **PROG.** button twice to exit.

11

5 Perform a recording.

Selecting a Sound

- Sounds recorded on the tape
According to your setting of "SAP SET" on the SET UP screen, the sound is recorded onto different tracks of the tape as below. Set "SAP SET" to "ON" or "OFF" appropriately.

Type of receiving broadcast	Setting of "SAP SET" on the SET UP screen	On-Screen Display (Press the DISPLAY button.)		Contents of recorded sound		
		"SAP"	"STEREO"	Normal sound track (Mono)	Hi-Fi sound track	
					L	R
Regular (monaural audio)	"ON" or "OFF"	not lit	not lit	MONO	MONO	MONO
Stereo	"ON" or "OFF"	not lit	lit	MONO (MIXED)	STEREO	
Regular+SAP	"ON"	lit	not lit	MONO	MONO	SAP
	"OFF"	lit	not lit	MONO	MONO	MONO
Stereo+SAP	"ON"	lit	lit	MONO	MONO	SAP
	"OFF"	lit	lit	MONO (MIXED)	STEREO	

4

- Sounds in playback

You can play SAP and/or stereo broadcasts with this VCR. Press the **AUDIO SELECT** button to select a desired sound.

1

Desired sound	L R indicators in the VCR display	Sound output
SAP sound	R(right) is on.	SAP
Stereo sound	Both R (right) and L (left) are on.	Stereo

Note

When the TV is connected to the RF OUT terminal of the VCR, the output sound is monaural.

4 TAPE COPYING/SIMULCAST RECORDING

Variable recordings are available by connecting other equipment to the VCR.

Copying a Tape

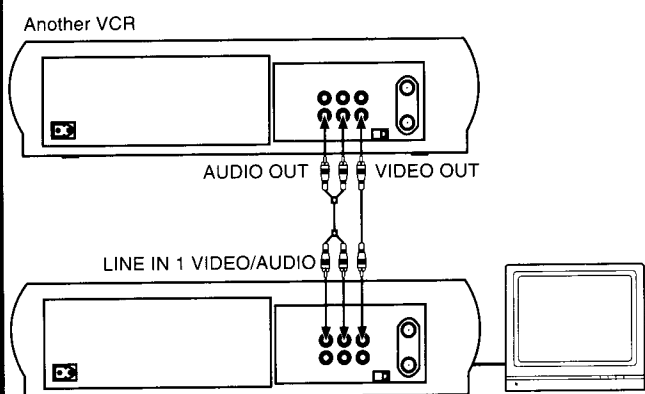

Preparation

- Set the VCR/TV selector to "VCR".
- Make the connection above.

13

- 1 Press the **INPUT SELECT** button repeatedly so that the indicator shows "L".

2

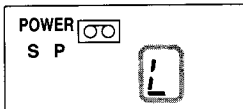

- 2 Press the **SP/SLP** button to select the recording tape speed.

20



- 3 Play the tape on another VCR for playback and press the **REC** buttons simultaneously to start recording on this VCR.

5



- 4 Press the **STOP** button on each VCR when copying is finished.

9



Warning

Tapes can be copied and used only in accordance with the applicable copyright laws. But, if the tape is covered by a copyright, it is illegal to copy it and/or charge an entrance fee to see it.

Notes

- The picture quality of the copied tape is slightly less than the original picture quality.
- When monitoring a picture being recorded, press the TV/VCR button to make the "VCR" indicator appear in the VCR display and select the video channel on the TV.

14

Simulcast Recording

When TV program such as MTV, HBO or MAX is being simulcast in FM stereo in your area, the VCR can also record the simulcast sound from an FM stereo tuner or receiver onto the Hi-Fi track and normal track.

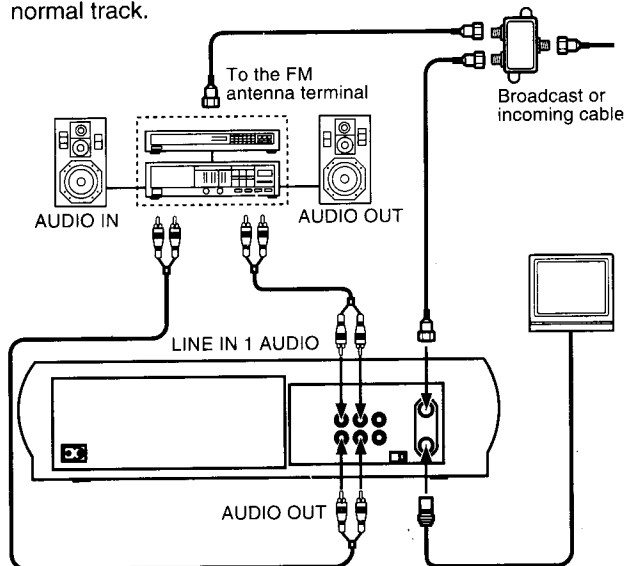

Preparation

- Connect the TV and stereo system to the VCR as above.
- Turn on the connected FM tuner and tune to the station for the simulcast program.

- 1 Press the **PROG.** button to display the MENU screen.

11

- 2 Select "SET UP" using the **CURSOR** ▲ or ▼ button, and press the **ENTER** button.

24

25

- 3 Select "SIMULCAST", and set to "ON".

24

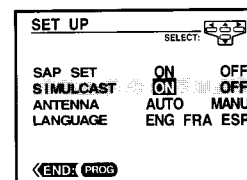
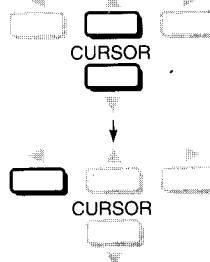

- 4 Press the **PROG.** button twice to exit.

11

- 5 Select the desired channel by using the **CHANNEL** buttons on the VCR or the **CH/TRK** buttons on the remote control.

G

16

- If you use a cable box, select a desired channel on the box.

- 6 Select the recording tape speed using the **SP/SLP** button.

20

- 7 Press the **REC** button to start recording.

5

B

- 8 Press the **STOP** button to stop recording.

9

E

RECORDING

5

BEFORE CALLING SERVICE PERSONNEL

Check the following symptoms before requesting servicing.

SYMPTOM	CAUSE	CORRECTION	See page
• No power.	• The power cord is not plugged in.	• Plug the power cord into the outlet firmly.	–
• Although the power is on, the VCR will not work.	• There is no cassette.	• Load a cassette.	15
• The clock does not work.	• There has been a power failure.	• Reset the clock.	12
• The timer does not work properly.	• The time is incorrect.	• Set the clock correctly.	12
• The picture does not appear on the TV screen.	• The video channel or video input mode is not set correctly.	• Set the TV channel to the video channel (3 or 4) or set the video input mode on the TV.	9, 10
	• The TV signal is weak.	• Adjust the antenna direction or use an optional antenna booster.	–
	• The power cord is not plugged in.	• Plug the power cord into the outlet firmly.	–
• The picture does not appear on the TV screen during recording and playback.	• The video channel or VCR mode is not set correctly.	• Press the TV/VCR button to select the VCR mode and set the TV channel to 3 or 4.	9, 18
• The VCR does not record.	• The loaded cassette has no safety tab.	• Use a cassette with a safety tab or cover the hole with adhesive tape.	15
• The playback picture is poor.	• Tracking is not set appropriately.	• Adjust the tracking manually.	16
	• The video heads are dirty.	• Clean the video heads with a commercially available cleaning tape.	–
• The desired sound is not heard, such as SAP, stereo, or regular sound.	• Setting of the AUDIO SELECT button is not correct.	• Select a desired sound using the AUDIO SELECT button.	21
• Noise is present in the Hi-Fi sound being played.	• Tracking is not set appropriately.	• Adjust the tracking manually.	16
• The timer recording function does not work.	• There is an error in programming.	• Reset the timer recording program.	19, 20
	• There is no cassette in the VCR.	• Load a cassette with the safety tab attached.	15
	• The cassette does not have the safety tab.	• Use another cassette with a safety tab or cover the hole with adhesive tape.	15
	• The timer indicator is not displayed.	• Press the two TIMER buttons simultaneously.	20
	• There has been a power failure.	• Reset the clock.	12
	• The cable box is not turned on.	• Turn on the cable box.	–
• The remote control does not work properly.	• The batteries are exhausted.	• Replace all batteries.	8
	• The remote control is operated beyond the operating range.	• Make sure the remote control is within 30° of the remote sensor on the VCR.	8
	• Too far from the VCR.	• Use the remote control within 7 m from the front of the VCR.	8
	• An obstacle may be in the way of the operation.	• Remove the obstacle.	–
	• Setting of the VCR/TV selector is not correct.	• Check the VCR/TV selector setting.	11
• The cassette is ejected immediately after it is loaded.	• The cassette was inserted with the label side not paralleling the compartment.	• Reload it carefully.	15
• The cassette does not go into the cassette compartment.	• There is already a cassette in the VCR.	• Eject the cassette and reload the new one.	15

LIMITED WARRANTY TOSHIBA VIDEO CASSETTE RECORDER

Toshiba America Consumer Products, Inc. ("TACP") and Toshiba Hawaii Inc. ("THI") make the following limited warranties. These limited warranties extend to the original consumer purchaser or any person receiving this set as a gift from the original consumer purchaser and to no other purchaser or transferee.

Limited Ninety (90) Day Warranty

TACP/THI warrant this product against defects in materials or workmanship for a period of ninety days after the date of original retail purchase. During this period, TACP/THI will repair a defective product or part, without charge to you. You must deliver the entire product to a TACP/THI Authorized Service Station. You are responsible for all transportation and insurance charges for the set to and from the Authorized Service Station.

Limited One (1) Year Warranty

TACP/THI further warrant the parts in this product against defects in materials or workmanship for a period of one (1) year after the date of original retail purchase. During this period, TACP/THI will replace a defective part without charge to you, except that if a defective part is replaced after ninety (90) days from the date of the original retail purchase, you pay labor charges involved in the replacement. You must also deliver the entire product to a TACP/THI Authorized Service Station. You are responsible for all transportation and insurance charges for the set to and from the Authorized Service Station.

Rental Units

The warranty for rental units begin with the first rental or thirty (30) days from the date of shipment to the rental firm, whichever comes first.

Commercial Units

Products sold and used for commercial use have a limited ninety (90) day warranty for all parts and labor.

Owner's Manual and Demographic Card

You should read the owner's manual thoroughly before operating this product. You should complete and mail the enclosed Demographic card within ten (10) days after you, or the person who has given you this product as a gift, purchased this product. This is one way to enable TACP/THI to provide you with better customer service and improved products. Failure to return the card will not affect your rights under this warranty.

Your Responsibility

The above warranties are subject to the following conditions:

- (1) You must retain your bill of sale or provide other proof of purchase.
- (2) You must notify an Authorized TACP/THI Service Station within thirty (30) days after you discover a defective product or part.
- (3) All warranty servicing of this product must be made by an Authorized TACP/THI Service Station.
- (4) These warranties are effective only if the product is purchased and operated in the U.S.A or Puerto Rico.
- (5) Labor service charges for set installation. Set up, adjustment of customer controls and installation of repair or antenna systems are not covered by this warranty. Reception problems caused by inadequate antenna systems are your responsibility.
- (6) Warranties extend only to defects in materials or workmanship as limited above and do not extend to any product or parts which have been lost or discarded by you or to damage to products or parts caused by misuse, accident, damage caused by Acts of God, such as lightning or fluctuations in electric power, improper installation, improper maintenance or use in violation of instructions furnished with us; or to units which have been altered or modified without authorization by you, TACP/THI or to damage to products or parts thereof of which have had the serial number removed, altered, defaced or rendered illegible.
- (7) At your option, after the warranty period has expired in the U.S.A. Call (800) 631-3811 to receive information concerning an exchange price. Payment must be enclosed with the product in the form of a certified check or money order. Forward your product to:
Toshiba America Consumer Products Inc.
Returns Center
1420C Toshiba Dr.
Lebanon, TN 37087
- (8) Upon receipt we will, at our option, replace your unit with a new or refurbished unit of equal value. Features may not be identical to your original product.
- (9) Physically damaged units are not acceptable for repair or exchange in or out of warranty and will be returned as received.

How to Obtain Warranty Service

- (1) Refer to the troubleshooting guide in your owner's manual. This check list may solve your problem.
- (2) Call the TACP toll free number **800-631-3811** within (30) days after you find a defective product or part.
- (3) Arrange for the delivery of the product to the Authorized TACP/THI Service Station. Products shipped to the Service Station must be insured and safely and securely packed, preferably in the original shipping carton, and a letter explaining the defect and also a copy of the bill of sale or other proof of purchase must be enclosed.

In the Continental United States contact:



In Hawaii contact

Toshiba Hawaii
327 Kamakee Street,
Honolulu, HA 96814
(808)-521-5377

All warranties implied by state law, including the implied warranties of merchantability and fitness for a particular purpose, are expressly limited to the duration of the limited warranties set forth above. With the exception of any warranties implied by state law as hereby limited, the foregoing warranty is exclusive and in lieu of all other warranty guarantees, agreements and similar obligations of manufacturer or seller with respect to the repair or replacement of any parts. In no event shall TACP/THI be liable for consequential or incidental damages.

No person, agent, distributor, dealer or company is authorized to change, modify or extend the terms of these warranties in any manner whatsoever. The time within which action may be commenced to enforce any obligation of TACP/THI arising under the warranty or under any statute, or law of the United States or any state thereof, is hereby limited to ninety (90) days from the date you discover or should have discovered the defect. This limitation does not apply to implied warranties arising under state law.

This warranty gives you specific legal rights and you may also have other rights which may vary from state to state. Some states do not allow limitation on how long an implied warranty lasts, when an action may be brought or the exclusion or limitation of incidental or consequential damages, so the above provisions may not apply to you.

ATTENTION CANADIAN CONSUMERS:

Canadian consumers are requested to complete the special Canadian "Warranty Registration Form" enclosed and forward this completed form with a copy of bill of sale to TOSHIBA OF CANADA to "Register and Validate" their warranty. Product must be purchased from an Authorized Canadian Dealer.

Products purchased in the U.S.A and used in Canada are not covered by these warranties.

IMPORTANT: PACKING AND SHIPPING INSTRUCTION

When you send the product to a Service Station, you should use the original carton box and packing material, then insert the original carton box containing the unit into another carton, using more packing material.

TOSHIBA AMERICA CONSUMER PRODUCTS, INC.