

Chapter 1

1.1 Introduction

The 4D845A motherboard is designed for using Intel P4 Front Side Bus Frequency 400MHz CPU, which utilize the Socket-478 design and the memory size expandable to 2.0GB.

This motherboard use the latest Intel I82845 chipset, applying 266MHz (Double Data Rate) Front Side Bus frequency and 266MHz memory interface delivers a clear upgrade path to the future generation of 266MHz processors, PC-1600/PC-2100 DDR DRAM. The 4D845A motherboard offers ULTRA ATA 100 to provide speedier HDD throughout that boosts overall system performance.

It is ideal for multi-tasking and fully supporting MS-DOS, Windows, Windows NT , Windows ME, Windows 2000, Novell, OS/2, Windows95/98, Windows 98SE, Windows XP, UNIX, Liunx , SCO UNIX etc. This manual also explains how to install the mainboard for operation, and how to setup your CMOS configuration with the BIOS setup program.

1.2 Package Contents

- HDD UDMA66/100 Cable.
- FDD Cable.
- -Flash Memory written for BIOS update.
- USB2 Cable **(Optional)**.
- Fully Setup CD Driver built in utility(Ghost, Antivirus, Adobe Acrobat).
- Manual.

1.3 Features

CPU Processor

- 400MHz System Interface speed.
- Single Socket 478 for Intel P4™ up to 2.2GHz or higher (Northwood Processor).
- Support Intel Netburst™ Micro-architecture.

Chipset

- Intel I82845 North Bridge.
- Intel I82801BA South Bridge.

PCI/AGP Speed

- Supports 33MHz PCI Bus speed.
- Supports AGP 66 MHz/1.5V for 4X device.



DDR DRAM Memory

- Supports 64/128/256/512....MB DDR module socket.
- Supports Synchronous DRAM(2.5V)
- Supports a maximum memory size of 2GB with DDR SDRAM.

Bus Slots

- Provide one AGP slot.
- Six 32-bit PCI bus.

Universal Serial Bus

- Supports two back Universal Serial Bus(USB)Ports and two front Universal serial Bus(USB)Ports.

Flash Memory

- Support 4 or 2MB flash memory.
- Support ESCD Function.

1.3 Features

BIOS

- The mainboard BIOS provides Plug & Play BIOS which detects the peripheral devices and expansion cards of the board automatically.
- BIOS support CD-ROM, SCSI, LAN BOOT, Temperature sensor, LAN, Alarm Bus CLK setup with BIOS.
- The mainboard provides a Desktop Management Interface (DMI) function which records your mainboard specifications.

IDE Built-in On Board

- Supports four IDE devices.
- Supports PIO Mode 5, Master Mode, high performance hard disk drives.
- Support Ultra DMA 33/66/100 Bus Master Mode.
- Supports IDE interface with CD-ROM.
- Supports high capacity hard disk drives.
- Support LBA mode.

PCI-Based AC 97 Digital Audio Processor

- AC 97 2.1 interface.
- 16 channels of high-quality sample rate conversion.
- 16x8 channel digital mixer.
- Stereo 10 band graphic equalizer.
- Sound Blaster and Sound Blaster Pro emulation.

WOL (Wake On LAN)

- Supports system power up from LAN ring up.

Smart Panel

- Supports BIOS Port 80H POST Code output to debug LED.

1.4 4D845A Motherboard Layout



- 6. Floppy Connector**
- 7. IDE Connectors (IDE1/IDE2)**
- 8. North Bridge (Intel 82845)**
- 9. South Bridge (Intel 82801BA)**
- 10. Fan Connectors (Fan1/2/3)**
- 11. CD Audio-In Connector (CDIN1/CDIN2)**
- 12. Wake-On-LAN Connector**
- 13. Telephone in Connector (TAD)**
- 14. Front USB2 Connector**
- 15. Front Panel Connector (PANEL1)**
- 16. CMOS Function Selection (JP7)**
- 17. CPU Clock Freq. Setting (JP4)**
- 18. AGP 4X/1.5V Protect (JP9)**
- 19. Onboard AC'97 Setting (JP11)**
- 20. IR Connector**
- 21. Smart Panel Function (ERR/JP5/JP2/JP8)(optional)**

1.5 CPU Installation

The motherboard operates with Socket 478 for Intel P4™ processor. The CPU should always has a Heat Sink and cooling fan attached to prevent overheating.

CPU Installation Procedures: Socket 478

1. Pull the lever sideways away from the socket then raise the lever to a 90-degree angle.
2. Locate Pin 1 in the socket and look for the white dot or cut edge in the CPU. Match Pin 1 with the white dot or cut edge then insert the CPU.
3. Press the lever down to complete the installation.
4. **Make sure the spec of the heatsink is good enough.**
5. **Please lock the fan on CPU very carefully, or you will damage the resistor array even circuit line on the mainboard.**

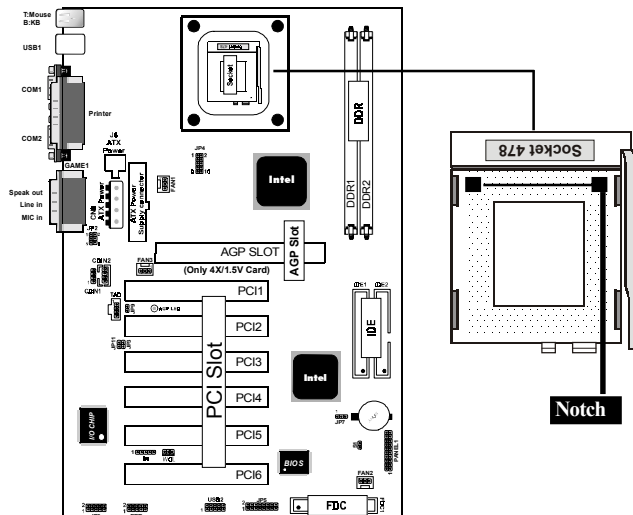

1.6 DDR DRAM Installation

The motherboard supports a maximized 2GB memory. It provides two 184-pin unbuffered DDR sockets. It supports 64MB to 1GB DDR memory module.

DDR DRAM Installation Procedures:

1. The DDR socket has a “Plastic Safety Tab” and the DDR memory module has an asymmetrical notch”, so the DDR memory module can only fit into the slot in one direction.
2. Push the tabs out. Insert the DDR memory modules into the socket at a 90-degree angle then push down vertically to fit onto place.
3. The Mounting Holes and plastic tabs should fit over the edge and hold the DDR memory modules in place.

Bank	Memory module
DDR 1	64MB, 128MB, 256MB, 512MB, 1GB
(Bank 0-1)	184 pin, 2.5V DDR DRAM
DDR 2	64MB, 128MB, 256MB, 512MB, 1GB
(Bank 2-3)	184 pin , 2.5V DDR DRAM
	Total System Memory (Max 2GB)

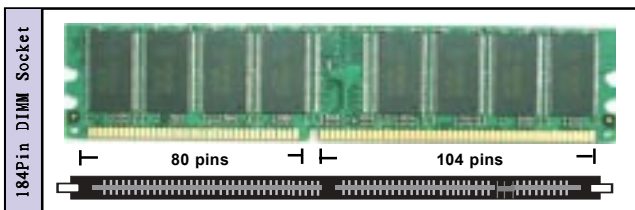

Note:

When you plug or unplug DDR module, you must check your power supply is off.

1.7 Connectors & Jumpers Setting

1.7.1 Back Panel I/O Connectors

The motherboard provides the following back panel connectors:

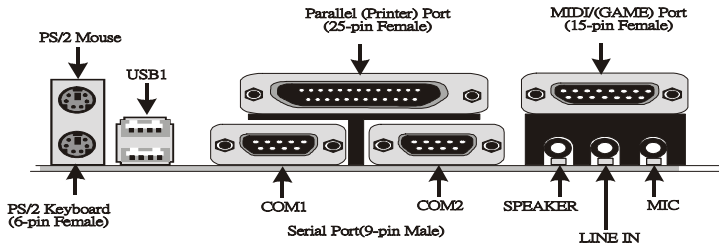

1.7.1.1 PS/2 Mouse / Keyboard CONN.

The motherboard provides a standard PS/2 mouse / Keyboard mini DIN connector for attaching a PS/2 mouse. You can plug a PS/2 mouse / Keyboard directly into this connector.

1.7.1.2 USB Connector: USB1

The motherboard provides a OHCI(Open Host Controller Interface)Universal Serial Bus Roots for attaching USB devices such as a keyboard, mouse and other USB devices. You can plug the USB devices directly into this connector.



Pin	Signal
1	+5V_SB
2	USBP0-(USBP1-)
3	USBP0+(USBP1+)
4	GND

1.7.1.3 The Serial Interfaces: COM1 / COM2

The serial interface port is sometimes referred to as an RS-232 port or an asynchronous communication port. Mice, printers, modems and other peripheral devices can be connected to a serial port. The serial port can also be used to connect your computer system. If you like to transfer the contents of your hard disk to another system, it can be accomplished by serial port.

COM1/COM2

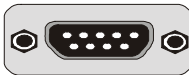

1.7.1.4 Parallel Interface Port

Unlike serial ports, parallel interface ports have been standardized and should not present any difficulty interfacing peripherals to your system. Sometimes called a Centronics port, the parallel port is almost exclusively used with printers. The parallel port on your system has a 25-pin, DB 25 connector.

1.7.1.5 Joystick / Midi Connector

You can connect a joystick or game pad to this connector.

1.7.1.6 Audio Port Connectors

Speaker out is a connector for Speakers or Headphones. Line in is used for external CD player, Tape player, or other audio devices. Mic is a connector for the microphones.

1.7.2 ATX Power Connectors: ATX/J8/CN9

-This connector supports the power button on-board. Using the ATX power supply, functions such as Modem Ring Wake-Up and Soft Power Off are supported on this motherboard. This power connector supports instant power-on functionality, which means that the system will boot up instantly when the power connector is inserted on the board.

-ATX 4-pin power connector only support +12V voltage.

Pin J8	Signal	Pin J8	Signal
1	GND	2	GND
3	+12V	4	+12V

Pin ATX	Signal	Pin ATX	Signal
1	3.3V	11	3.3V
2	3.3V	12	-12V
3	GND	13	GND
4	5V	14	PS-ON
5	GND	15	GND
6	5V	16	GND
7	GND	17	GND
8	PW-OK	18	-5V
9	5V_SB	19	5V
10	12V	20	5V

Pin CN9	Signal	Pin CN9	Signal
1	NC	2	NC
3	GND	4	+12V

Note:

1. When you use PIII power supply, you must plug CN9 & ATX power connector on your system.
2. Make sure that the ATX PIII power supply can take at least 1Amp load on the 5Volt standby lead (5VSB).
3. When you use P4 power supply, you must plug J8 & ATX power connector on your system.

Important:

Before you switch on your power supply, please make sure:

1. Memory Module installing is OK.
2. Power supply setting is OK.
3. AGP card 4X/1.5V is OK.

1.7.3 Floppy Disk Connector: FDC

This connector supports the provided floppy drive ribbon cable. After connecting the single end to the board, connect the two plugs on the other end to the floppy drives.

1.7.4 Hard Disk Connectors: IDE1/IDE2

These connectors support the provided IDE hard disk ribbon cable. After connecting the single end to the board, connect the two plugs at the other end to your hard disk.

If you install two hard disks, you must configure the second drive to Slave mode by setting its jumper settings. BIOS now supports SCSI device or IDE CD-ROM boot up (see "HDD Sequence SCSI/IDE First" & "Boot Sequence" in the BIOS Features Setup of the BIOS SOFTWARE) (Pin 20 is removed to prevent inserting in the wrong orientation when using ribbon cables with pin 20 plugged).

1.7.5 Fan Connectors: Fan1/2/3

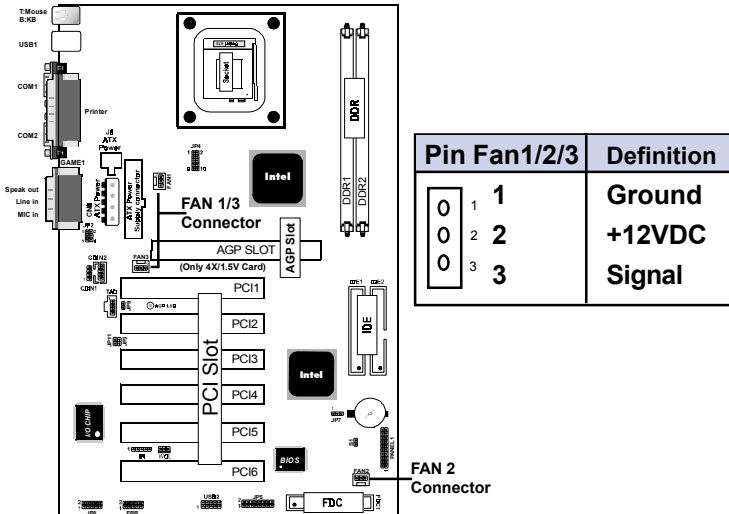

These connectors support cooling fans of 1Amp or less. Orientate the fans so that the heatsink fins allow airflow to go across the onboard heat sink(s) instead of the expansion slots. Depending on the fan manufacturer, the wiring and plug may be different. The red wire should be positive, while the black should be ground. Connect the fan's plug to the board taking into consideration the polarity of the this connector.

1.7.6 CD Audio-In Connectors: CD-IN1/CDIN2

CDIN1 and CDIN2 are the connectors for CD-Audio Input signal. Please connect it to CD-ROM CD-Audio output connector.

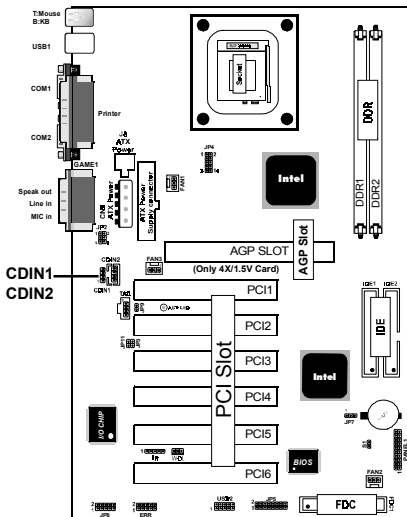

Pin CDIN1	Definition
1	CD-L
2	GND
3	GND
4	CD-R

Pin CDIN2	Definition
1	GND
2	CD-L
3	GND
4	CD-R

1.7.7 Wake-On-LAN Connector: WOL

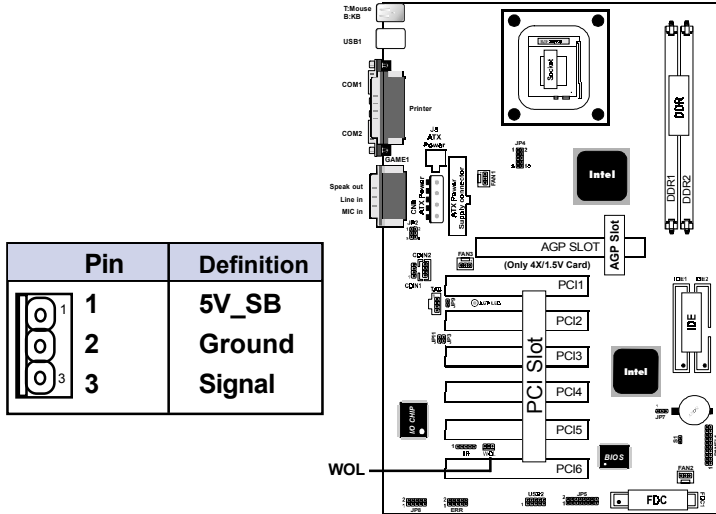

1.7.8 Telephone in Connector: TAD(optional)

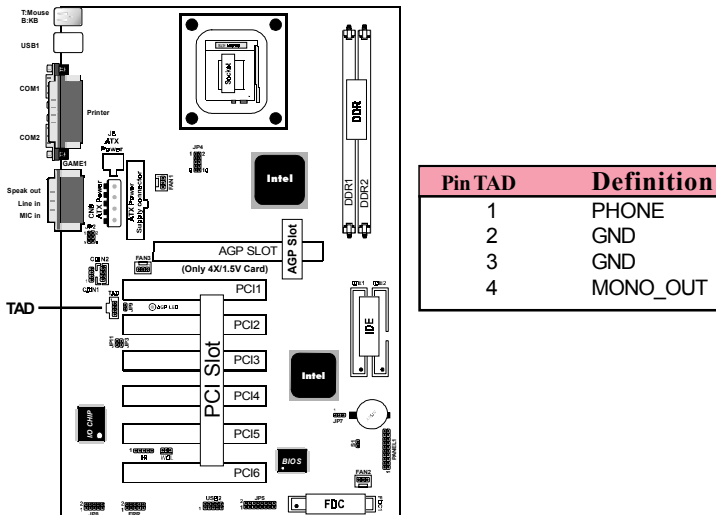

ATX Power Switch (PW_BT)

The system power is controlled by a momentary switch connected to this lead. Pushing the button once will switch the system ON.

Power LED Lead (PW_LED)

The system power LED lights when the system power is on.

Speaker Connector (SPEAKER)

The speaker (onboard or offboard) provides error beep code information during the Power Self-Test when the computer cannot use the video interface. The speaker is not connected to the audio subsystem and does not receive output from the audio subsystem.

Hard Drive LED Connector (HD_LED)

This connector supplies power to the cabinet IDE activity LED. Read and write activity by devices connected to the Primary or Secondary IDE connectors will cause the LED to light up.

Keyboard Lock (KBLOCK)

The header is for setting keyboard locked.

Reset Switch Lead (RESET)

The connector can be connected to a momentary SPST type switch that is normally open. When the switch is closed, the motherboard resets and runs the POST.

SMI Suspend Switch Lead (SUS_LED) (Disabled)

This allows the user to manually place the system into a suspend mode of Green mode. System activity will be instantly decreased to save electricity and expand the life of certain components when the system is not in use. This 2-pin connector (see the figure) connects to the case-mounted suspend switch. If you do not have a switch for the connector, you may use the "Turbo Switch" instead since it does not have a function. If you want to use this connector, the "Suspend Switch" in the Power Management Setup of the BIOS SOFTWARE section should be on the default setting of Enable.

1.7.11 CMOS Function Selection: JP7

A battery be used to retain the mainboard configuration in CMOS RAM.

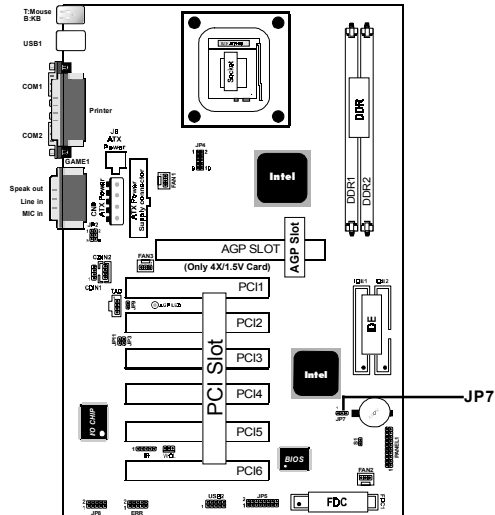

Pin	Definition
1-2	Normal (Default)
2-3	Clear CMOS

NOTE:

(Please follow the procedure below to clear CMOS data.)

- (1) Remove the AC power line.
- (2) JP7(2-3) Closed.
- (3) Wait five seconds.
- (4) JP7(1-2) Closed.
- (5) AC Power on.
- (6) Reset your desired password or clear CMOS data.

1.7.12 CPU Clock Freq. Setting: JP4

Overclocking is operating a CPU/Processor beyond its specified frequency. JP4 jumper is used for the CPU Front Side Bus Frequencies from 100MHz to 133MHz.

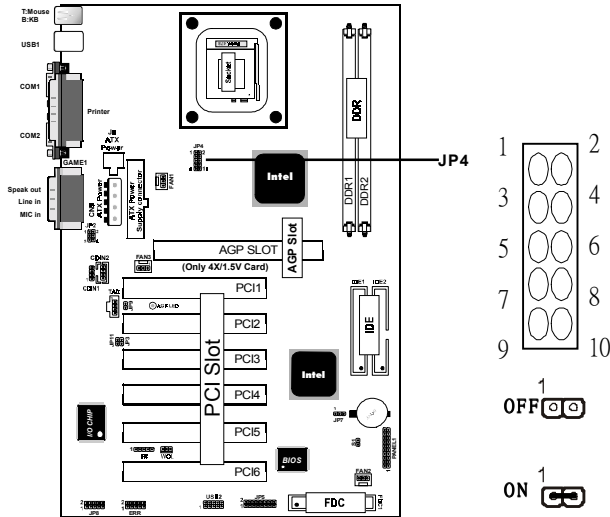



1-2	3-4	5-6	7-8	9-10	CPU(MHz)	PCI(MHz)
ON	ON	ON	ON	OFF	100	33.3
OFF	ON	ON	ON	OFF	33.3	33.3
OFF	ON	ON	ON	OFF	Auto	Auto

Note:



We don't recommend you overclocking, since it will make the CPU life short and get the risk of CPU damage.

1.7.13 AGP 4X/1.5V Protect: JP9

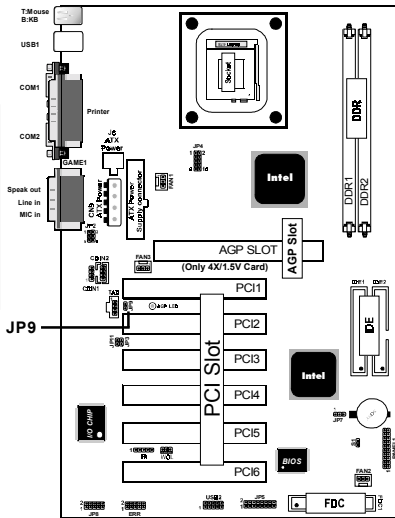
Pin JP9	Definition
On 	Enabled (Default)
Off 	Disabled



1.7.14 Onboard AC'97 Setting: JP11

Pin JP11	Definition
On 	Enabled
Off 	Disabled (Default)

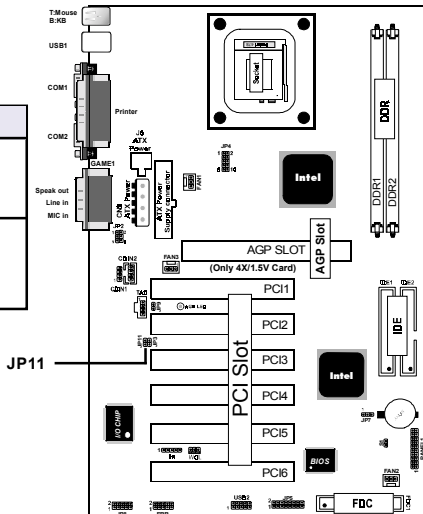

1.7.15 Smart Panel Function: SP-J1/SP-J6/SP-J5/SP-J7

(optional)

Note:

The motherboard provides the pin leads for Smart Panel II. If you want POST Error Code or Smart Panel II function, please refer to Smart Panel II (S P D 8 4 5 A) manual.

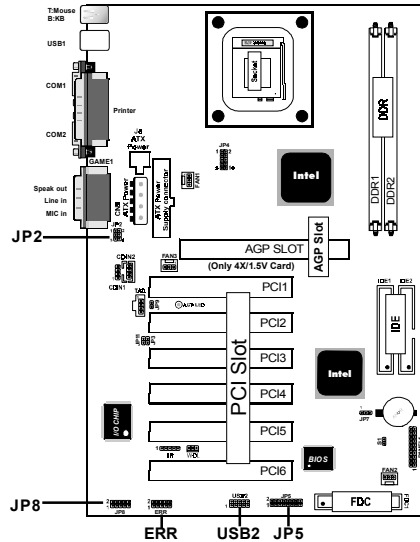

The Smart Panel provides the following panel connectors:



1.7.15.1 Port 80 Debug Function: SP-J6

For Smart Panel connector(SP-J6) to M/B (ERR).

Pin SP-J6	Assignment	Pin SP-J6	Assignment
1	ERD4	2	ERD0
3	ERD5	4	ERD1
5	ERD6	6	ERD2
7	ERD7	8	ERD3
9	GND	10	NC

1.7.15.2 Second BIOS Connector: SP-J1

For Smart Panel connector(SP-J1) to M/B (JP5).

Pin SP-J1	Assignment	Pin SP-J1	Assignment
1	VCC3	2	+5V
3	PCI_RST#	4	33MHz
5	CLAD0	6	P66DET
7	CLAD1	8	S66DET
9	GND	10	GND
11	CLAD2	12	HINT
13	CLAD3	14	FWH_IDD1
15	CLAD4	16	VCC3

1.7.15.3 AUX Line Connector: SP-J5

For Smart Panel connector(SP-J5) to M/B (JP2).

Pin SP-J5	Assignment	Pin SP-J5	Assignment
1	LINE_OUT_L	2	LINE_OUT_R
3	LINE_IN_L	4	LINE_IN_R
5	MIC_IN_L	6	MIC_IN_R

1.7.15.4 Front COM2 Header Conn.: SP-J7

For Smart Panel connector(SP-J7) to M/B (JP8).

Pin SP-J7	Assignment	Pin SP-J7	Assignment
1	DCD	2	RX
3	TX	4	DTR
5	GND	6	DSR
7	RTS	8	CTS
9	RI		

1.7.15.5 Front USB3,4 Header Conn.: SP-J8(USB2)

For Smart Panel connector(SP-J8) to M/B (USB2).

Pin SP-J8	Assignment	Pin SP-J8	Assignment
1	VCC	2	GND
3	P2-	4	GND
5	P2+	6	P3+
7	GND	8	P3-
9	GND	10	VCC

Chapter 2

Introduction

This chapter discusses the Award Setup program built into the ROM BIOS. The Setup program allows the user to modify the basic system configuration. This special information is then stored in battery-backed RAM so that it retains the setup information when the power is turned off.

The Award BIOS installed in your computer system's ROM (Read Only Memory) is a custom version of an industry standard BIOS. This means that it supports Intel P4 Processor. The BIOS provides critical low-level support for standard devices such as disk drives and serial and parallel ports.

The rest of this manual is intended to guide you through the process of configuring your system using Setup.

Plug and Play Support

This AWARD BIOS supports the Plug and Play Version 1.0A specification. ESCD(Extended System Configuration Data)write is supported.

EPA Green PC Support

This AWARD BIOS supports Version 1.03 of the EPA Green PC specification.

PCI Bus Support

This AWARD BIOS also supports Version 2.1 of the Intel PCI (Peripheral Component Interconnect)local bus specification.

APM Support

This AWARD BIOS supports Version 1.1&1.2 of the Advanced Power Management(APM) specification. Power management features are implemented via the System Management Interrupt(SMI). Sleep and Suspend power management modes are supported. Power to the hard disk drives and video monitors can be managed by this AWARD BIOS.

DRAM Support

SDRAM (Synchronous DRAM) are supported.

Support CPU

This AWARD BIOS supports the Intel P4 Processor.

Using Setup

In general, you use the arrow keys to highlight items, press <Enter>to select, use the <PgUp>and <PgDn>keys to change entries, press<F1>for help and press <Esc>to quit. The following table provides more detail about how to navigate in the Setup program by using the keyboard.

Note:

(BIOS version 1.0 is for reference only. If there is a change in BIOS version, please use the actual version on the BIOS.)

Keystroke	Function
Up arrow	Move to previous item
Down arrow	Move to next item
Left arrow	Move to the item on the left(menu bar)
Right arrow	Move to the item on the right(menu bar)
Esc	Main Menu: Quit without saving changes Submenus: Exit Current page to the next higher level menu
Move Enter	Move to item you desired
PgUp key	Increase the numeric value or make changes
PgDn key	Decrease the numeric value or make changes
+Key	Increase the numeric value or make changes
-Key	Decrease the numeric value or make changes
Esc Key	Main menu-Quit and not save changes into CMOS Status Page Setup Menu and option Page Setup Menu-Exit Current page and return to Main Menu
F1 Key	General help on Setup navigation keys.
F5 Key	Load previous values from CMOS
F6 Key	Load the fail-safe defaults from BIOS default table
F7 Key	Load the optimized defaults
F10 Key	Save all the CMOS changes and exit

2.1 Main Menu

Once you enter AWARD BIOS CMOS Set up Utility, the Main Menu will appear on the screen. The Main Menu allows you to select from several setup function. Use the arrow keys to select among the items and press<Enter> to accept and enter the sub-menu.

“WARNING”

The information about BIOS defaults on manual (Figure 1,2,3,4,5,6,7,8,9,10,11,12,13,14)is just for reference, please refer to the BIOS installed on the board for updated information.

© **Figure 1. Main Menu**

CMOS Setup Utility-Copyright (C) 1984-2001 Award Software

Standard CMOS Features	Frequency/Voltage Control
Advanced BIOS Features	Load Fail-Safe Defaults
Advanced Chipset Features	Load Optimized Defaults
Integrated Peripherals	Set Supervisor Password
Power Management Setup	Set User Password
PNP/PCI Configurations	Save & Exit Setup
PC Health Status	Exit Without Saving
Esc : Quit F9 : Menu in BIOS ←→↑↓: Select Item	
F10 : Save & Exit Setup	
Time , Date , Hard Disk Type ...	

Standard CMOS Features

This setup page includes all the items in standard compatible BIOS.

Advanced BIOS Features

This setup page includes all the items of the BIOS special enhanced features.

Advanced Chipset Features

This setup page includes all the items of the Chipset special enhanced features.

Integrated Peripherals

This selection page includes all the items of the IDE hard drive and Programmed Input/Output features.

Power Management Setup

This setup page includes all the items of the power management features.

PnP/PCI Configurations

This setup page includes the user defined or default IRQ Setting.

PC Health Status

This page shows the hardware Monitor information of the system.

Frequency / Voltage Control

This setup page controls the CPU's clock and frequency ratio.

Load Fail-Safe Defaults

Use this menu to load the BIOS default values for the minimal/stable performance for your system to operate.

Load Optimized Defaults

These settings are more likely to configure a workable computer when something is wrong. If you cannot boot the computer successfully, select the BIOS Setup options and try to diagnose the problem after the computer boots. These settings do not provide optional performance.

Set Supervisor Password

Change, set, or, disable password. It allows you to limit access to the system and Setup, or just to Setup.

Set User Password

You can specify both a User and a Supervisor password. When you select either password option, you are prompted for a 1-6 character password. Enter the password and then retype the password when prompted.

Save & Exit Setup

Save CMOS value changes to CMOS and exit setup.

Exit Without Saving

Abandon all CMOS value changes and exit setup.

2.2 Standard CMOS Features

This item in the Standard CMOS Setup Menu is divided into 10 categories. Each category includes no, one or more than one setup items. Use the arrow keys to highlight the item and then use the <PgUp> or <PgDn> keys to select the value you want in each item.

© Figure 2. Standard CMOS Features

CMOS Setup Utility-Copyright (C) 1984-2001 Award Software

Standard CMOS Features

Date(mm:dd:yy)	Tue,Jun 6 2000	Item Help
Time (hh:mm:ss)	11:26:10	
IDE Primary Master	None	Menu Level
IDE Primary Slave		Change the day,
IDE Secondary Master		month,year
IDE Secondary Master	None	and century.
Drive A	1.44M,3.5 in	
Drive B	None	
Video	EGA/VGA	
Halt On	All,But Keyboard	
Base Memory	640K	
Extended Memory	65472K	
Total	1024K	

←→↑↓: Move Enter:Select +/-/PU/PD:Value F10:Save ESC:Exit
 F1:General Help F5:Previous Values F6:Fail-Safe Defaults
 F7:Optimized Defaults

Main Menu Selections

This table shows the selections that you can make on the Main Menu.

Item	Options	Description
Date	Month DD YYYY	Set the system,date. Note that the 'Day' automatically changes when you set the data.
IDE Primary Master	Options are in its sub menu.	Press<Enter> to enter the sub menu of detailed.
IDE Primary Slave	Options are in its sub menu.	Press<Enter> to enter the sub menu of detailed.
IDE Secondary Master	Options are in its sub menu.	Press<Enter> to enter the sub menu of detailed.
IDE Secondary Slave	Options are in its sub menu.	Press<Enter> to enter the sub menu of detailed.
Drive A Drive B	None 360K,5.25in 1.2M,5.25in 720K,3.5in 1.44M,3.5in 2.88M,3.5in	Select the type of floppy disk drive installed in your system.
Video	EGA/VGA CGA 40 CGA 80 MONO	Select the default video device.

Item	Options	Description
Halt On	All Errors No Errors All, but Keyboard All, but Diskette All, but Disk/Key	Select the situation in which you want the BIOS to stop the POST process and notify.
Base Memory	N/A	Displays the amount of conventional memory detected during boot up.
Extended Memory	N/A	Displays the amount of conventional memory detected during boot up.
Total Memory	N/A	Displays the total memory available in the system.

CMOS Setup Utility-Copyright (C) 1984-2001 Award Software IDE

Primary Master

IDE HDD Auto-Detection	Press Enter	Item Help
IDE Primary Master Access Mode	Auto	Menu Level
Capacity	13022MB	
Cylinder	25232	
Head	16	
Precomp	0	
Landing Zone	25231	
Sector	61	

←→↑↓: Move Enter:Select +/-/PU/PD:Value F10:Save ESC:Exit
 F1:General Help F5:Previous Values F6:Fail-Safe Defaults
 F7:Optimized Defaults

2.3 Advanced BIOS Features

© Figure 3. Advanced BIOS Features

CMOS Setup Utility-Copyright (C) 1984-2001 Award Software

Advanced BIOS Features

Virus Warning	Disabled	Item Help
CPU L1 & L2 Cache	Enabled	
Quick Power On Self Test	Enabled	Menu Level
First Boot Device	Floppy	
Second Boot Device	HDD-0	Allows you to
Third Boot Device	CD-ROM	choose the
Boot Other Device	Enabled	VIRUS warning
Swap Floppy Drive	Disabled	feature for IDE
Boot Up Floppy Seek	Enabled	Hard Disk boot
Boot Up NumLock Status	On	sector protection.
Gate A20 Option	Fast	If this function
Typematic Rate Setting	Disabled	is enabled and
Typematic Rate (Chars/Sec)	6	someone attempts
Typematic Delay (Msec)	250	to write data into
Security Option	Setup	this area, BIOS
APIC Mode	Enabled	will show a
MPS Version Control For OS	1.4	warning message
OS Select For DRAM >64MB	Non-OS2	on screen and
Report No FDD For WIN 95	No	alarm beep
Full Screen Logo Show	Disabled	
Small Logo (EPA) Show	Disabled	

←→↑↓: Move Enter:Select +/-/PU/PD:Value F10:Save ESC:Exit

F1:General Help F5:Previous Values F6:Fail-Safe Defaults

F7:Optimized Defaults

Virus Warning

This option allows you to choose the VIRUS Warning feature for IDE Hard Disk boot sector protection. If this function is enabled and someone attempts to write data into this area, BIOS will show a warning message on screen and alarm beep.

The Choices: Disabled(default), Enabled.

CPU L1 & L2 Cache

This fields allow you to Enable or Disable the CPU's "Level 1 & Level 2" cache. Caching allows better performance.

Enabled (default) Enabled cache.

Disabled Disabled cache.

Quick Power On Self Test

This category speeds up Power on self-Test(POST) after you power up the computer. If it is set to Enable, BIOS will shorten or skip some check items during POST.

Enabled (default) Enabled quick POST.

Disabled Normal POST.

First/Secondary/Third Boot Device

This BIOS attempts to load the operating system from the devices in the sequence selected in these items.

The Choices: Floppy, LS120, HDD-0, SCSI, CDROM, HDD-1, HDD-2, HDD-3, ZIP100, USB-FDD, USB-ZIP, USB-CDROM, USB-HDD, LAN, Disabled.

Boot Other Device

The Choices: Enabled(default), Disabled.

Swap Floppy Drive

If the system has two floppy drives, you can swap the logical drive name assignments.

The Choices: Disabled(default), Enabled.

Boot Up Floppy Seek

Seek disk drives during boot up. Disabled speeds boot-up.

The Choices: Enabled(default), Disabled.

Boot Up NumLock Status

Select power on state for Numlock.

- On (default)** Numpad is number keys.
Off Numpad is arrow keys.

Gate A20 Option

Select if chipset or keyboard controller should control Gate A20.

- Normal** A pin in the keyboard controller controls Gate A20.
Fast (default) Lets chipset control Gate A20.

Typematic Rate Setting

- Enabled** Enabled this option to adjust the keystroke repeat rate.
Disabled (default) Disabled.

Typematic Rate (Char/Sec)

Range between 6(**default**) and 30 characters per second. This option controls the speed of repeating keystrokes.

Typematic Delay (Msec)

This option sets the time interval for displaying the first and the second characters.

The Choices: 250(default), 500, 750, 1000.

Security Option

This category allows you to limit access to the system and Setup, or just to Setup.

- System** The system will not boot and access to Setup will be denied if the correct password is not entered in prompt.

Setup (default)

The system will boot, but access to Setup will be denied if the correct password is not entered in prompt.

APIC Mode

The Choices: Enabled(default), Disabled.

MPS Version Control For OS

The Choices: 1.4(default), 1.1.

OS Select For DRAM >64MB

Select the operating system that is running with greater than 64MB of RAM on the system.

The Choices: Non-OS2(default), OS2

Report No FDD For Window 95

No (default)

Assign IRQ6 For FDD.

Yes

FDD Detect IRQ6
Automatically.

Full Screen Logo Show

The Choices: Disabled(default), Enabled.

Small Logo (EPA) Show

The Choices: Disabled(default), Enabled.

2.4 Advanced Chipset Features

This section allows you to configure the system based on the specific features of the installed chipset. This chipset manages bus speeds and access to system memory resources, such as DRAM and external cache. It also coordinates communications of the PCI bus. It must be stated that these items should never need to be altered. The default settings have been chosen because they provide the best operating conditions for your system. The only time you might consider making any changes would be if you discovered that data was lost while using your system.

© Figure 4. Advanced Chipset Features

CMOS Setup Utility-Copyright(C) 1984-2001 Award Software

Advanced Chipset Features

DRAM Timing Selectable	By SPD	Item Help
DRAM Latency Time	2.5	
Active to Precharge Delay	7	Menu Level
DRAM RAS# to CAS# Delay	3	
DRAM RAS# Precharge	3	
DRAM Data Integrity Mode	Non-ECC	
Memory Frequency For	Auto	
Buffer Strength Control	Press Enter	
DRAM Read Thermal Mgmt	Disabled	
System BIOS Cacheable	Enabled	
Video BIOS Cacheable	Disabled	
Video RAM Cacheable	Disabled	
Memory Hole At 15M-16M	Disabled	
Delayed Transaction	Enabled	
Delay Prior to Thermal	16 Min	
AGP Aperture Size (MB)	64	

←→↑↓: Move Enter:Select +/-PU/PD:Value F10:Save ESC:Exit
 F1:General Help F5:Previous Values F6:Fail-Safe Defaults
 F7:Optimized Defaults

DRAM Timing Selectable

The DRAM timing is controlled by the DRAM Timing Registers. The Timings programmed into this register are dependent on the system design.

The Choices: By SPD(default), Manual.

DRAM Latency Time

- | | |
|---------------|-------------------------------|
| 1.5 | Set DRAM latency Time to 1.5. |
| 2 | Set DRAM latency Time to 2. |
| 2.5 (default) | Set DRAM latency Time to 2.5. |
| 3 | Set DRAM latency Time to 3. |

Note:

If you are using “Nanya” brand DDR memory, please setting default is 2.

Active to Precharge Delay

- | | |
|-------------|--------------------------------|
| 7 (default) | Set DRAM Precharge Delay in 7. |
| 6 | Set DRAM Precharge Delay in 6. |
| 5 | Set DRAM Precharge Delay in 5. |

DRAM RAS# to CAS# Delay

- | | |
|-------------|--------------------------------------|
| 3 (default) | Set DRAM RAS# to CAS# delay 3 SCLKs. |
| 2 | Set DRAM RAS# to CAS# delay 2 SCLKs. |

DRAM RAS# Precharge

- | | |
|-------------|------------------------------------|
| 3 (default) | Set DRAM RAS# Precharge Time to 3. |
| 2 | Set DRAM RAS# Precharge Time to 2. |

DRAM Data Integrity Mode

The Choices: Non-ECC(default), ECC.

CMOS Setup Utility-Copyright(C) 1984-2001 Award Software

Buffer Strength Control

CMD Strength Control	4X	Item Help
DQ/DQS Strength Control	4X	Menu Level
CKE X16 Strength Control	Auto	
CKE X8 Strength Control	Auto	
CS# X16 Strength Control	Auto	
CS# X8 Strength Control	Auto	
CK X16 Strength Control	Auto	
CKE X8 Strength Control	Auto	
CKE X16 Strength Control	Auto	
RCVE out# Strength Control	Auto	

←→↑↓: Move Enter:Select +/-/PU/PD:Value F10:Save ESC:Exit
 F1:General Help F5:Previous Values F6:Fail-Safe Defaults
 F7:Optimized Defaults

Memory Frequency For

This option is support memory frequency auto detect.

The Choices: Auto(default), Disabled.

DRAM Read Thermal Mgmt

This option is support memory read thermal management.

The Choices: Disabled(default), Enabled.

System BIOS Cacheable

When enabled, the access to the system BIOS ROM address at F0000H-FFFFFFH is cached.

The Choices: Enabled(default), Disabled.

Video BIOS Cacheable

Enabled Enabled Video BIOS Cacheable.

Disabled (default) Disabled Video BIOS Cacheable.

Video RAM Cacheable

Enabled Enabled Video RAM Cacheable.

Disabled (default) Disabled Video RAM Cacheable.

Memory Hole At 15-16M

In order to improve performance, certain space in memory can be reserved for ISA cards. This memory must be mapped into the memory's space below 16MB.

The Choices: Disabled(default), Enabled.

Delayed Transaction

Enabled (default) Slow speed ISA device in system.

Disabled Disabled.

Delay Prior to Thermal

The Choices: 16 min(default), 4min, 8min, 32min.

AGP Aperture Size (MB)

64 (default) AGP Graphics Aperture Size is 64 MB.

The Choices: 4M, 8M, 16M, 32M, 128M, 256M.

2.5 Integrated Peripherals

© Figure 5. Integrated Peripherals

CMOS Setup Utility-Copyright (C) 1984-2001 Award Software

Integrated Peripherals

On-Chip Primary PCI IDE	Enabled	Item Help
IDE Primary Master PIO	Auto	Menu Level
IDE Primary Slave PIO	Auto	
IDE Primary Master UDMA	Auto	
IDE Primary Slave UDMA	Auto	
On-Chip Secondary PCI IDE	Enabled	
IDE Secondary Master PIO	Auto	
IDE Secondary Slave PIO	Auto	
IDE Secondary Master UDMA	Auto	
IDE Secondary Slave UDMA	Auto	
USB Controller	Enabled	
USB Keyboard Support	Enabled	
USB Mouse Support	Enabled	
AC97 Audio	Auto	
AC97 Modem	Auto	
Init Display First	AGP	
IDE HDD Block Mode	Enabled	
Power On Function	Button Only	
KB Power On Password	Enter	
Hot Key Power On	Ctrl-F1	
Onboard FDC Controller	Enabled	
Onboard Serial Port 1	3F8/IRQ4	
Onboard Serial Port 2	2F8/IRQ3	
UART Mode Select	Normal	
RxD,TxD Active	Hi,Lo	
IR Transmission Delay	Enabled	
UR2 Duplex Mode	Half	
Use IR Pins	IR/Rx2Tx2	
Onboard Parallel Port	378/IRQ7	
Parallel Port Mode	SPP	
EPP Mode Type	EPP1.7	
ECP Mode Use DMA	3	
PWRON After PWR-Fail	Off	
Game Port Address	201	
Midi Port Address	330	
Midi Port IRQ	10	

←→↑↓: Move Enter:Select +/-/PU/PD:Value F10:Save ESC:Exit
 F1:General Help F5:Previous Values F6:Fail-Safe Defaults
 F7:Optimized Defaults

On-Chip Primary PCI IDE

Enabled (default)

Enabled onboard 1st channel
IDE port.

Disabled

Disabled onboard 1st channel
IDE port.

IDE Primary Master PIO(for onboard IDE 1st channel)

Auto (default)	BIOS will automatically detect the IDE HDD Accessing mode.
Mode 0~4	Manually set the IDE Accessing mode.

IDE Primary Slave PIO(for onboard IDE 2nd channel)

Auto (default)	BIOS will automatically detect the IDE HDD Accessing mode.
Mode 0~4	Manually set the IDE Accessing mode.

IDE Primary Master UDMA

Auto (default)	BIOS will automatically detect the IDE HDD Accessing mode.
Disabled	Disabled.

IDE Primary Slave UDMA

Auto (default)	BIOS will automatically detect the IDE HDD Accessing mode.
Disabled	Disabled.

On-Chip Secondary PCI IDE

Enabled (default)	Enabled onboard 2nd channel IDE port.
Disabled	Disabled onboard 2nd channel IDE port.

IDE Secondary Master PIO(for onboard IDE 1st channel)

Auto (default)	BIOS will automatically detect the IDE HDD Accessing mode.
Mode 0~4	Manually set the IDE Accessing mode.

IDE Secondary Slave PIO(for onboard IDE 2nd channel)

Auto (default)	BIOS will automatically detect the IDE HDD Accessing mode.
Mode 0~4	Manually set the IDE Accessing mode.

IDE Secondary Master UDMA**Auto (default)**

BIOS will automatically detect the IDE HDD Accessing mode.

Disabled

Disabled.

IDE Secondary Slave UDMA**Auto (default)**

BIOS will automatically detect the IDE HDD Accessing mode.

Disabled

Disabled.

USB Controller**Enabled (default)**

Enabled USB Controller.

Disabled

Disabled USB Controller.

USB Keyboard Support**Enabled (default)**

Enabled USB Keyboard Support.

Disabled

Disabled USB Keyboard Support.

USB Mouse Support**Enabled (default)**

Enabled USB Mouse Support.

Disabled

Disabled USB Mouse Support.

AC 97 Audio**Auto(default)**

BIOS will automatically detect onboard Audio.

Disabled

Disabled.

AC 97 Modem**Auto(default)**

BIOS will automatically detect onboard Modem.

Disabled

Disabled.

Init Display First**PCI Slot**

Set Init Display First to PCI Slot.

AGP (default)

Set Init Display First to onboard AGP.

IDE HDD Block Mode**Enabled (default)**

Enabled IDE HDD Block Mode.

Disabled

Disabled IDE HDD Block Mode.

Power On Function**Password**

Enter from 1 to 7 characters to set the Keyboard Power On Password.

Hot Key

Hot Key.

Mouse Left

Mouse Left.

Mouse Right

Mouse Right.

Any Key

Any Key.

Button Only (default)

Button Only.

Keyboard 98

If your keyboard has an Owner key button, you can press the key to power on your system.

KB Power On Password**Enter**

Enter from 1 to 7 characters to set the keyboard Power On Password.

Hot Key Power On**Ctrl-F1 (default)**

First you must choose the Power On by Hot Key function then Enter from 1 to 8 characters to set the Hot Key Power On your system.

Ctrl-F2**Ctrl-F3****Ctrl-F4****Ctrl-F5****Ctrl-F6****Ctrl-F7****Ctrl-F8**

Onboard FDC Controller

Enabled (default)	Enabled onboard FDC Controller.
Disabled	Disabled onboard FDC Controller.

Onboard Serial Port1

Select an address and corresponding interrupt for the first and second serial ports.

The Choices: **3F8/IRQ4**(default), Auto, (2F8/IRQ3), (3E8/IRQ4), (2E8/IRQ3), Disabled.

Onboard Serial Port 2

Auto	BIOS will automatically setup the Serial Port 2 address.
3F8/IRQ4	Enabled onboard Serial Port 2 and address is 3F8.
2F8/IRQ3 (default)	Enabled onboard Serial Port 2 and address is 2F8.
3E8/IRQ4	Enabled onboard Serial Port 2 and address is 3E8.
2E8/IRQ3	Enabled onboard Serial Port 2 and address is 2E8.
Disabled	Disabled.

UART Mode Select

This item allows you to select which Infra Red(IR) function of the onboard I/O chip you wish to use.

The Choices: **Normal**(default), IrDA, SCR, ASKIR.

UR2 Duplex Mode

This item allows you to select which Infra Red(IR) function of the onboard I/O chip you wish to use.

The Choices: **Half** (default), Full.

ECP Mode Use DMA

The Choices: **3**(default), 1.

Onboard Parallel Port

This item allows you to select the I/O address with which to access the onboard parallel port controller.

Disabled.

378/IRQ7. (default)

278/IRQ5.

3BC/IRQ7.

Parallel Port Mode

SPP (default)

Using Parallel port as Standard Parallel Port.

EPP

Using Parallel port as Enhanced Parallel Port.

ECP

Using Parallel port as Extended Capabilities Port.

ECP/EPP

Using Parallel port as ECP/EPP mode.

PWRON After PWR-Fail

This option will determine how the system will power on after a power failure.

The Choices: Off(default), On, Former-Str.

Game Port Address)

201 (default)

Set onboard game port to 201.

209

Set onboard game port to 209.

Disabled

Disabled.

Midi Port Address

290

Set Midi Port address to 290.

300

Set Midi Port address to 300.

330 (default)

Set Midi Port address to 330.

Disabled

Disabled.

Midi Port IRQ

10 (default)

Set Midi Port IRQ to 10.

5

Set Midi Port IRQ to 5.

2.6 Power Management Setup

The Power Management Setup allows you to configure your system to most effectively save energy while operating in a manner consistent with your own style of computer use.

© Figure 6. Power Management Setup

CMOS Setup Utility-Copyright (C) 1984-2001 Award Software

Power Management Setup

ACPI Function	Enabled	Item Help
ACPI Suspend Type	S1(POS)	
Run VGA BIOS if S3 Resume	Auto	Menu Level
Power Management	User Define	
Video Off Method	DPMS	
Video Off In Suspend	Yes	
Suspend Type	Stop Grant	
Modem Use IRQ	4	
Suspend Mode	Disabled	
HDD Power Down	Disabled	
Soft-Off by PWR-BTTN	Instant-Off	
CPU THRM-Throttling	50.0%	
Wake-Up by PCI Card	Enabled	
Power On by Ring	Enabled	
Resume by Alarm	Disabled	
Data (of Month) Alarm	0	
Time (of hh:mm:ss) Alarm	0 0 0	
**Reload Global Timer Events **		
Primary IDE 0	Disabled	
Primary IDE 1	Disabled	
Secondary IDE 0	Disabled	
Secondary IDE 1	Disabled	
FDD,COM,LPT Port	Disabled	
PCI PIRQ[A-D]#	Disabled	

←→↑↓: Move Enter:Select +/-/PU/PD:Value F10:Save ESC:Exit

F1:General Help F5:Previous Values F6:Fail-Safe Defaults

F7:Optimized Defaults

ACPI Function

This item display status of the Advanced Configuration and Power Management (ACPI).

ACPI Suspend Type

The item allows you to select the suspend type under ACPI operating system.

S1(POS) (default)	Power on Suspend.
S3(STR)	Suspend to RAM.

Power Management

This option allows you to set each mode individually. When not disabled, each of the ranges are from 1 min. to 1 hr. except for HDD Power Down which ranges from 1 min. to 15 min. and disable.

The Choices: User Define (default), Min Saving, Max Saving.

Video Off Method

This determines the manner in which the monitor is blanked.

V/H SYNC+Blank	This selection will cause the system to turn off the vertical and horizontal synchronization ports and write blanks to the video buffer.
Blank Screen	This option only writes blanks to the video buffer.
DPMS Support (default)	Initial display power management signaling.

Video Off In Suspend

This field determines when to activate the video off feature for monitor power management.

The Choices: Yes(default), No.

Suspend Type

Stop Grant (default)	Set Suspend type is stop grant.
PwrOn Suspend	Set Suspend type is Power on Suspend.

Modem Use IRQ

This determines the IRQ, which can be applied in Modem use.

4 (default)

3/5/7/9/10/11/NA.

Suspend Mode

Disabled (default)

Disabled.

1 min - 1 Hour

Set the timer to enter Suspend Mode.

HDD Power Down

By default, this is “Disabled”, meaning that no matter the mode of the rest of system, the hard drive will remain ready. Otherwise, you have a range of choices from 1 to 15 minutes or Suspend. This means that you can select to have your hard disk drive be turned off after a selected number of minutes or when the rest of the system goes into a suspend mode.

Disabled (default)

Disabled.

1 - 15 mins

Enabled.

Soft-Off by PWR-BTTN

Pressing the power button for more than 4 seconds forces the system to enter the Soft-Off state when the system has “hung”.

The Choices: Instant-Off(default), Delay 4 Sec.

Wake-Up by PCI Card

Enabled

Enabled.

Disabled (default)

Disabled.

Power On By Ring

Enabled

Enabled.

Disabled (default)

Disabled.

CPU THRM-Throttling**50.0% (default)****Monitor CPU Temp. will cause system to slow down****CPU Duty Cycle to 12.5% / 25.0% / 37.5% / 62.5% /
70.5% / 87.5%****Resume by Alarm****Disabled (default)**

Disabled.

Enabled

Enabled.

Primary IDE 0/1**Disabled (default)**

Disabled.

EnabledEnabled monitor Primary IDE
0/1 for Green event.**Secondary IDE 0/1****Disabled (default)**

Disabled.

EnabledEnabled monitor Secondary
IDE 0/1 for Green event.**FDD, COM, LPT Port****Disabled (default)**

Disabled.

EnabledEnabled monitor FDD, COM,
LPT Port.**PCI PIRQ[A-D]#****Disabled (default)**

Ignore PCI PIRQ[A-D]#

Active.

Enabled

Monitor PCI PIRQ[A-D]#

Active.

2.7 PnP/PCI Configurations

This section describes configuring the PCI bus system. PCI or Personal Computer Interconnect, is a system which allows I/O devices to operate at speeds nearing the speed of the CPU itself when communicating with its own special components. This section covers some very technical items and it is strongly recommended that only experienced users make any changes to the default settings.

© Figure 7. PnP/PCI Configurations

CMOS Setup Utility-Copyright (C) 1984-2001 Award Software

PnP/PCI Configurations

Reset Configuration Data	Disabled	Item Help
Resources Controlled By	Auto(ESCD)	Menu Level
IRQ Resources	Press Enter	
PCI/VGA Palette Snoop	Disabled	When resources are controlled manually, assign each system interrupt a type, depending on the type of device using the interrupt
Assign IRQ For USB	Enabled	

←→↑↓: Move Enter:Select +/-/PU/PD:Value F10:Save ESC:Exit
 F1:General Help F5:Previous Values F6:Fail-Safe Defaults
 F7:Optimized Defaults

Reset Configuration Data

The system BIOS supports the PnP feature so the system needs to record which resource is assigned and proceeds resources from conflict. Every peripheral device has a node, which is called ESCD. This node records which resources are assigned to it. The system needs to record and update ESCD to the memory locations. These locations (4K) are reserved at the system BIOS. If Disabled (Default) is chosen, the system's ESCD will update only when the new configuration varies from the last one. If Enabled is chosen, the system is forced to update ESCDs and then is automatically set to the "Disabled" mode.

IRQ3	assigned to:PCI/ISA PnP
IRQ4	assigned to:PCI/ISA PnP
IRQ5	assigned to:PCI/ISA PnP
IRQ6	assigned to:PCI/ISA PnP
IRQ7	assigned to:PCI/ISA PnP
IRQ8	assigned to:PCI/ISA PnP
IRQ9	assigned to:PCI/ISA PnP
IRQ10	assigned to:PCI/ISA PnP
IRQ11	assigned to:PCI/ISA PnP
IRQ12	assigned to:PCI/ISA PnP
IRQ13	assigned to:PCI/ISA PnP
IRQ14	assigned to:PCI/ISA PnP
IRQ15	assigned to:PCI/ISA PnP
DMA-0	assigned to:PCI/ISA PnP
DMA-1	assigned to:PCI/ISA PnP
DMA-2	assigned to:PCI/ISA PnP
DMA-3	assigned to:PCI/ISA PnP
DMA-4	assigned to:PCI/ISA PnP
DMA-5	assigned to:PCI/ISA PnP
DMA-6	assigned to:PCI/ISA PnP
DMA-7	assigned to:PCI/ISA PnP

The above settings will be shown on the screen only if “Manual” is chosen for the resources controlled by function.

Legacy is the term, which signifies that a resource is assigned to the ISA Bus and provides for non-PnP ISA add-on cards. PCI/ISA PnP signifies that a resource is assigned to the PCI Bus or provides for ISA PnP add-on cards and peripherals.

Resources Controlled By

By Choosing “Auto” (default), the system BIOS will detect the system resources and automatically assign the relative IRQ and DMA channel for each peripheral. By Choosing “Manual”, the user will need to assign IRQ & DMA for add-on cards. Be sure that there are no IRQ/DMA and I/O port conflicts.

IRQ Resources

When resources are controlled manually, assign each system interrupt a type, depending on the type of device using the interrupt.

PCI / VGA Palette Snoop

Choose Disabled or Enabled. Some graphic controllers which are not VGA compatible take the output from a VGA controller and map it to their display as a way to provide boot information and VGA compatibility.

However, the color information coming from the VGA controller is drawn from the palette table inside the VGA controller to generate the proper colors, and the graphic controller needs to know what is in the palette of the VGA controller. To do this, the non-VGA graphic controller watches for the write access to the VGA palette and registers the snoop data. In PCI based systems, the Write Access to the palette will not show up on the ISA bus if the PCI VGA controller responds to the Write.

In this case, the PCI VGA controller should not respond to the Write, it should only snoop the data and permit the access to be forwarded to the ISA bus. The non-VGA ISA graphic controller can then snoop the data on the ISA bus. Unless you have the above situation, you should disable this option.

Disabled (default)	Function Disabled.
Enabled	Function Enabled.

Assign IRQ For USB

Lets the user choose which IRQ to assign for the USB.

2.8 PC Health Status

© Figure 8. PC Health Status

CMOS Setup Utility-Copyright (C) 1984-2001 Award Software

PC Health Status

CPU Warning Temperature	Disabled	Item Help
Current System Temp.		
Current CPU1 Temperature		
Current Fan1 Speed		
Current Fan2 Speed		
Current Fan3 Speed		
Vcore V		
VCC3 V		
+5V		
+12V		
-12V		
-5V		
VBAT(V)		
5VSB(V)		

←→↑↓: Move Enter:Select +/-PU/PD:Value F10:Save ESC:Exit
 F1:General Help F5:Previous Values F6:Fail-Safe Defaults
 F7:Optimized Defaults

Current Voltage(V) CPU Vcore /VCC3/+12V/+5V/5VSB/ VBAT

Detect system's voltage status automatically.

Current CPU1/System Temperature(°C /°F)

This field displays the current CPU temperature,if your computer contains a monitoring system.

Current Fan1/Fan2 / Fan3 Speed

These field displays the current speed of up to System Fans,if your computer contains a monitoring system.

CPU Warning Temperature(°C)

Disabled (default)	Disabled.
50°C / 122°F	Monitor CPU Temp.at 50°C / 122°F.
53°C / 127°F	Monitor CPU Temp.at 53°C / 127°F.
56°C / 133°F	Monitor CPU Temp.at 56°C / 133°F.
63°C / 145°F	Monitor CPU Temp.at 63°C / 145°F.
66°C / 151°F	Monitor CPU Temp.at 66°C / 151°F.
70°C / 158°F	Monitor CPU Temp.at 70°C / 158°F.

2.9 Frequency / Voltage Control

◎ Figure 9. Frequency / Voltage Control

CMOS Setup Utility-Copyright (C) 1984-2001 Award Software

Frequency / Voltage Control

CPU Vcore Select	Default	Item Help
CPU Clock Ratio	24X	
Auto Detect PCI CLK	Enabled	Menu Level
Spread Spectrum	Disabled	
CPU Clock	100MHz	

←→↑↓: Move Enter:Select +/-/PU/PD:Value F10:Save ESC:Exit
 F1:General Help F5:Previous Values F6:Fail-Safe Defaults
 F7:Optimized Defaults

CPU Vcore Select

This option is support CPU vcore select.

The Choices: +1.850V~+1.100V.

CPU Clock Ratio

This option will not be shown if you are using a CPU with the locked ratio.

The Choices: X8~X50.

Auto Detect PCI CLK

This item allows you to enable/disable auto detect DIMM / PCI CLOCK.

The Choices: **Enabled**(default), Disabled.

Spread Spectrum

This function is designed for the EMI test only.

The Choices: **Disabled**(default), Enabled.

CPU Clock

This item allows you to select the CPU Host Clock (CPU/ PCI).

The Choices: **100MHz**(default)~132MHz

2.10 Load Fail-Safe Defaults

When you press <Enter> on this item, you get a confirmation dialog box with a message similar to:

© Figure 10. Load Fail-Safe Defaults

CMOS Setup Utility-Copyright (C) 1984-2001 Award Software

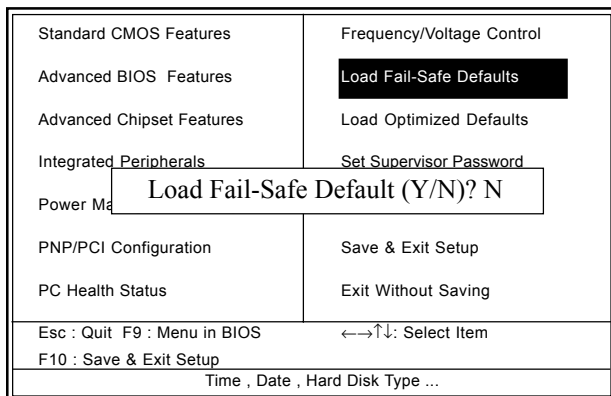

Pressing ‘Y’ loads the default values that are factory settings for optimal performance of system operations.

2.11 Load Optimized Defaults

When you press <Enter> on this item, you get a confirmation dialog box with a message similar to:

© Figure 11. Load Optimized Defaults

CMOS Setup Utility-Copyright (C) 1984-2001 Award Software

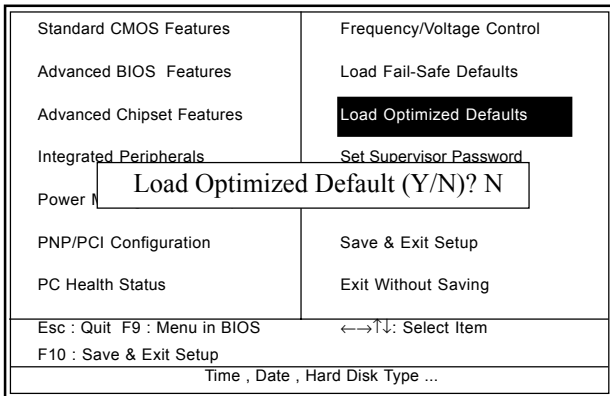

Pressing ‘Y’ loads the default values that are factory settings for optimal performance of system operations.

2.12 Set Supervisor / User Password

© Figure 12. Set Supervisor / User Password

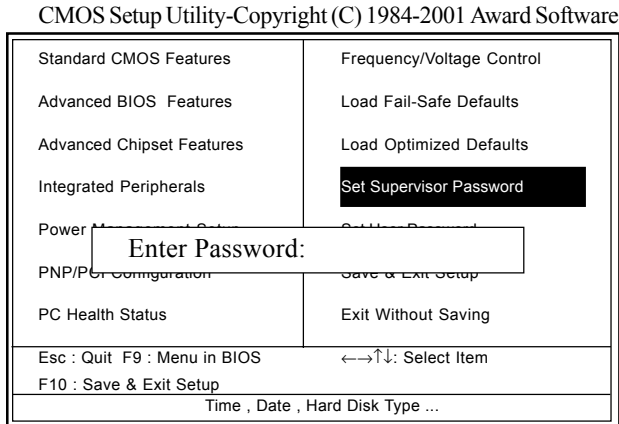

When you select this function, the following message will appear at the center of the screen to assist you in creating a password.

Enter Password

Type a password, up to eight characters, and press <Enter>. The password you type now will clear any previously entered password from CMOS memory. You will be asked to confirm the password. Type the password again and press <Enter>. You may also press <ESC> to abort the selection and not enter a password. To disable the password, just press <Enter> when you are prompted to enter a password. A message will confirm that you wish to disable the password. Once the password is disabled, the system will boot and you can enter setup freely.

Password Disabled

If you select “System” at the Security Option of BIOS Features Setup Menu, you will be prompted for the password every time when the system is rebooted, or any time when you try to enter Setup. If you select “Setup” at the Security Option of BIOS Features Setup Menu, you will be prompted only when you try to enter Setup.

2.13 Save & Exit Setup

© Figure 13. Save & Exit Setup

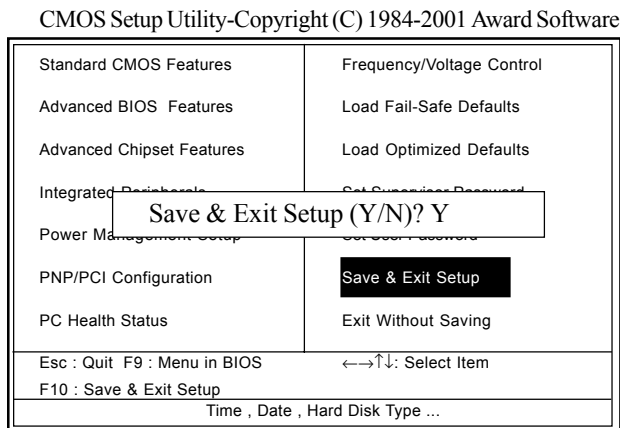

Typing “Y” will quit the Setup Utility and save the user setup value to RTC CMOS RAM.

Typing “N” will return to the Setup Utility.

2.14 Exit Without Saving

© Figure 14. Exit Without Saving

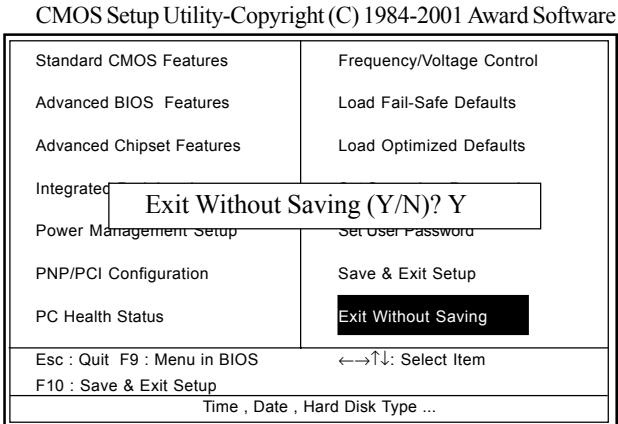

Typing “Y” will quit the Setup Utility without saving to RTC CMOS RAM.

Typing “N” will return to the Setup Utility.

Chapter 3

There are motherboard drivers and utilities included in ACORP Bonus CD disc. You don't need to install all of them in order to boot your system. But after you finish the hardware installation, you have to install your operation system first (such as windows 98) before you can install any drivers or utilities. Please refer to your operation system installation guide.

Note: Please follow recommended procedure after install Windows ME and Windows 98.

3.1 Auto-run Menu

You can use the auto-run menu of Bonus CD disc. Choose the utility or driver and select model name.



3.2 Installing Intelinf Driver

This item install the Intel Chipset Software installation Utility that enables Plug-n-Play INF support for Intel chipset components. This utility installs to the target system the Windows INF files that outline to the operating system how the chipset components will be configured.



(1)
Click "Driver" Item.



(2)
Click "Chipset" Item.



(3)
Click "Intel Chipsets Installation" Item.



(4)
Click "Next".

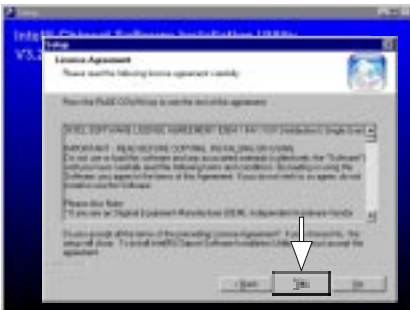

(5)
Click "Yes".

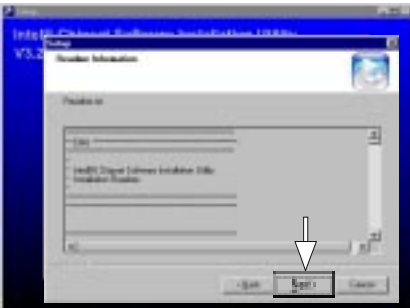

(6)
Click "Next".

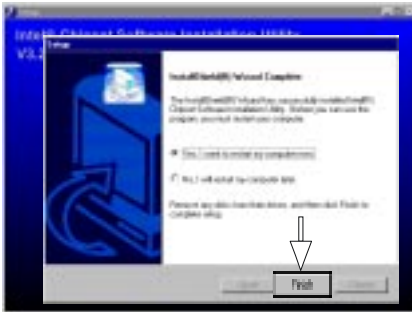

(7)
Click "Finish".

Note:
Install the Intel INF Driver before installing the Intel Application Accelerator Driver.

3.3 Installing Application Accelerator Driver

This item install the Intel Application Accelerator for Microsoft Windows 98/98SE/ME/NT4.0/2000/XP. This program is designed to improve performance of the storage sub-system and overall system performance.

We recommend that:
If you operating system like Windows 98/98SE/NT4.0, please install the Ultra Driver. Besides, take note of the IAA and Ultra Driver can't using at the same time.



(1)
Click "Driver" Item.



(2)
Click "Chipset" Item.



(3)
Click "Intel Application Accelerator/Ultra ATA Storage Driver" Item.



(4)
For Ultra ATA Driver.
Click "Windows 98SE/
Windows NT" Item.

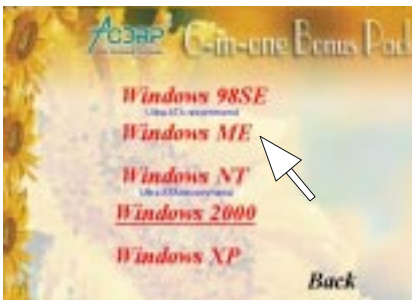

(5)

(6)
Click "OK".(7)
For Intel Application
Accelerator Driver.
Click "Windows ME/
Windows XP/2000" Item.

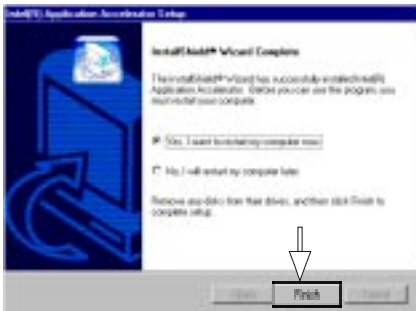

(8)

(9)
Click "Finish".(10)
Click "OK".

3.4 Installing Audio Driver

This motherboard comes with an AC97 CODEC and the sound controller is in Intel South Bridge chipset. You can find the sound driver from the Bonus Pack CD disc auto-run menu.



(1)
Click
"Driver" Item.



(2)
Click "Audio" Item.



(3)
Click "ALC100" Item.



(4)
For Win NT
, Win 2000, WinXP
& Win 9X_ME system.
Select your O.S. system.

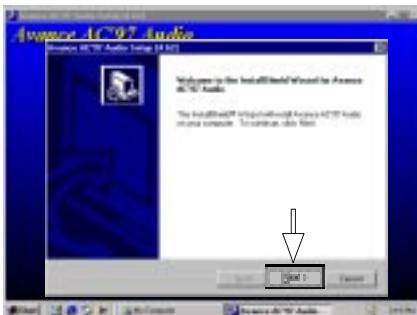

(5)
Click "Next".



(6)
Click "Finish".

4D845A System Compatibility Test Report

**** Note:**
 This test report is for your reference, we would like to suggest you to use these devices that we had approved.

A. CPU & Memory Compatibility Test Pass

CPU MEMORY	Wuillamte 1.5G	Wuillamte 1.7G	Wuillamte 1.8G	Wuillamte 1.9G	Wuillamte 2G
SAMSUNB-266 [049]	128X1	128X2	128X2	128X1	128X2
K4H280838B-TC(D)	D1 PASS	D1,D2 PASS	D1,D2 PASS	D1 PASS	D1,D2 PASS
HYUNDAT(KINGSTON)-266 [114A]	128X1	128X1	128X2	128X1	128X2
HYU5DU28822T-H(S)	D2 PASS	D2 PASS	D1,D2 PASS	D1 PASS	D1,D2 PASS
NANYA(APACER)-266 [0129]	256X1	256X2	256X2	256X1	256X2
NT5DS16M8AT-7K(D)	D1 PASS	D1,D2 PASS	D1,D2 PASS	D1 PASS	D1,D2 PASS
INFINEON(APACER)-266 [0126]	256X1	256X2	256X2	256X1	256X2
HYB25D256800AT-7(D)	D2 PASS	D1,D2 PASS	D1,D2 PASS	D1 PASS	D1,D2 PASS

CPU MEMORY	Wuillamte 1.5G	Wuillamte 1.7G	Wuillamte 1.8G	Wuillamte 1.9G	Wuillamte 2G
HYUNDAI(KINGSTON)-266 [128A]	128X1	128X1	128X1	128X2	128X1
HY5DU28822T-H(S)	D2 PASS	D2 PASS	D1 PASS	D1,D2 PASS	D1 PASS
SAMSUNG(SILAN)-266 [103]	256X1	256X1	256X2	256X2	256X1
K4H280838B-TCB0(D)	D2 PASS	D1 PASS	D1,D2 PASS	D1,D2 PASS	D1 PASS
INFINEON-266 [0128]	512X1	512X1	512X1	512X1	512X1
HYB25D256800AT-7(D)	D1 PASS	D2 PASS	D2 PASS	D1 PASS	D1 PASS
SAMSUNG(ARMAS)-266 [118]	128X1	128X2	128X2	128X1	128X2
K4H280838B-TCB0(S)	D1 PASS	D1,D2 PASS	D1,D2 PASS	D2 PASS	D1,D2 PASS

CPU MEMORY	Wuillamte 1.5G	Wuillamte 1.7G	Wuillamte 1.8G	Wuillamte 1.9G	Wuillamte 2G
NANYA(SILAN)-266	256X1	256X2	256X1	256X1	256X2
NT5DS16M8AT-7K(D)	D2 PASS	D1,D2 PASS	D2 PASS	D1 PASS	D1,D2 PASS
HYUNDAI(CHIN)-266	256X1	256X1	256X2	256X1	256X2
HY5DU28822AT-L(D)	D1 PASS	D2 PASS	D1,D2 PASS	D2 PASS	D1,D2 PASS
NANYA-266 [0045]	512X1	512X1	512X1	512X1	512X1
NT5DS32M8AT-7K(D)	D2 PASS	D2 PASS	D1 PASS	D2 PASS	D1 PASS
ELIXIR-266 [0143]	256X2	256X1	256X2	256X1	256X1
N2DS12880AT-75B(D)	D1,D2 PASS	D1 PASS	D1,D2 PASS	D1 PASS	D1 PASS

B. AGP Display Compatibility Test

Win98 SE 1024 x 768 x 32 bit

AGP Model	Vendor	AGP Mode	Dirver Version	3D MARK 2001 Bench Mode	Quake III Demo 001		
					frames	seconds	fps
GEFORCE 3	MSI	4X	4.13.01.2183	6631	1346	7.7	173.9
GEFORCE 3	WINFAST	4X	4.13.01.2183	6620	1346	7.8	173.3
GEFORCE 3	ELSA	4X	4.13.01.2183	6619	1346	7.8	173.4
TITANIUM500	WINFAST	4X	4.13.01.2183	7197	1346	7.6	176.2
GEFORCE 2 MX400	PROLINK	4X	4.13.01.2183	2501	1346	9.5	141.8
GEFORCE 256	ACORP	4X	4.13.01.2183	1885	1346	11	122.2
GEFORCE 2 GTS	WINFAST	4X	4.13.01.2183	3565	1346	8	168.9
GA-GF2560	GIGABYTE	4X	4.13.01.2183	2165	1346	9.9	136.2
READEON 8500	ATI	4X	4.13.7189	7018	1346	8.1	165.6

4D845A System Compatibility Test Report

Win98 SE 800 x 600 x 16 bit

AGP Model	Vendor	AGP Mode	Dirver Version	3D MARK 2000 Bench Mode	Quake III Demo 001		
					frames	seconds	fps
GEFORCE 3	MSI	4X	4.13.01.2183	9189	1346	7.7	175.9
GEFORCE 3	WINFAST	4X	4.13.01.2183	9202	1346	7.7	175.6
GEFORCE 3	ELSA	4X	4.13.01.2183	9249	1346	7.6	176.8
TITANIUM500	WINFAST	4X	4.13.01.2183	9586	1346	7.6	176
QUADRO2 MXR	ELSA	4X	4.13.01.2183	5151	1346	8.3	161.5
TNT2 ULTRA	NVIDIA	4X	4.13.01.2183	3683	1346	17.7	76.1
V3800/32M	ASUS	4X	4.13.01.2183	1861	1346	22	61.3
S320V/16M	WINFAST	4X	4.13.01.2183	2483	1346	22.9	58.7
GEFORCE 2 MX	ACORP	4X	4.13.01.2183	4912	1346	10.2	131.5

Win 2000 1024 x 768 x 32 bit

AGP Model	Vendor	AGP Mode	Dirver Version	3D MARK 2001 Bench Mode	Quake III Demo 001		
					frames	seconds	fps
GEFORCE 3	MSI	4X	5.13.01.2183	6593	1346	7.1	188.6
GEFORCE 3	WINFAST	4X	5.13.01.2183	6595	1346	7.2	188.1
GEFORCE 3	ELSA	4X	5.13.01.2183	6575	1346	7.1	189
TITANIUM500	WINFAST	4X	5.13.01.2183	7141	1346	7.1	189.1
GEFORCE 2 MAX	WINFAST	4X	5.13.01.2183	2284	1346	9.2	146
MS-8826	MSI	4X	5.13.01.2183	2289	1346	9.2	146
V7100 PRO	ASUS	4X	5.13.01.2183	2622	1346	8.3	162.9
GLADIAC GTS PRO	ELSA	4X	5.13.01.2183	3232	1346	7.2	186.5
G450	MATROX	4X	5.12.01.1720	1144	1346	21.5	62.7

Win2000 800 x 600 x 16 bit

AGP Model	Vendor	AGP Mode	Dirver Version	3D MARK 2000 Bench Mode	Quake III Demo 001		
					frames	seconds	fps
GEFORCE 3	MSI	4X	5.13.01.2183	6610	1346	7.1	189.2
GEFORCE 3	WINFAST	4X	5.13.01.2183	8348	1346	7.1	188.4
GEFORCE 3	ELSA	4X	5.13.01.2183	8372	1346	7.2	186.8
TITANIUM500	WINFAST	4X	5.13.01.2183	7185	1346	7.1	190.6
MS-8806	MSI	4X	5.13.01.2183	4530	1346	14.3	94.4
GEFORCE 256	CREATIVE	4X	5.13.01.2183	5486	1346	7.7	174.1
GEFORCE 2 MX64	WINFAST	4X	5.13.01.2183	7100	1346	7.7	175.5
MS-8829	MSI	4X	5.13.01.2183	4902	1346	10.1	133.6
GLADIAC	ELSA	4X	5.13.01.2183	7118	1346	7.7	175.2

Win XP 1024 x 768 x 32 bit

AGP Model	Vendor	AGP Mode	Dirver Version	3D MARK 2001 Bench Mode	Quake III Demo 001		
					frames	seconds	fps
GEFORCE 3	MSI	4X	5.13.01.2183	6689	1346	7.1	188.9
GEFORCE 3	WINFAST	4X	5.13.01.2183	6659	1346	7.2	187
GEFORCE 3	ELSA	4X	5.13.01.2183	6692	1346	7.2	186.9
TITANIUM500	WINFAST	4X	5.13.01.2183	7225	1346	7.3	184.5
MS-8817	MSI	4X	5.13.01.2183	2431	1346	9.3	144.3
GA-GF1280RT	GIGABYTE	4X	5.13.01.2183	2513	1346	9.3	145.5
V7700	ASUS	4X	5.13.01.2183	3334	1346	7.5	180.6
RADEON DDR	ATI	4X	6.13.3276	3026	1346	9.2	146.3
G550	MATROX	4X	5.12.01.1210	1329	1346	29.3	45.9

4D845A System Compatibility Test Report

Win XP 800 x 600 x 16 bit

AGP Model	Vendor	AGP Mode	Dirver Version	3D MARK 2000 Bench Mode	Quake III Demo 001		
					frames	seconds	fps
GEFORCE 3	MSI	4X	5.13.01.2183	8534	1346	7.1	188.8
GEFORCE 3	WINFAST	4X	5.13.01.2183	8502	1346	7.1	190.4
GEFORCE 3	ELSA	4X	5.13.01.2183	8532	1346	7.1	190.2
TITANIUM500	WINFAST	4X	5.13.01.2183	8706	1346	7.2	188.1
GEFORCE 2 GTS ULTRA	CREATIVE	4X	5.13.01.2183	8401	1346	7.2	187.5
GEFORCE 2 MX	WINFAST	4X	5.13.01.2183	6991	1346	7.9	169.6
GEFORCE 256	ELSA	4X	5.13.01.2183	8740	1346	7.2	186.5
MS-8815	MSI	4X	5.13.01.2183	8654	1346	7.2	186.8
GEFORCE 2 MX	GENUINE	4X	5.13.01.2183	6622	1346	8.2	165.2

C. PCI/ISA Device Compatibility Test

Device Model	Slot	Vendor Model	O.S.	Driver Version	Result
All PCI/ISA Device Card	PCI	AHA-2940UW	Win98 SE	V2.21a	PASS
	PCI	YAMAHA 724	Win98 SE	4.00.1020	PASS
	PCI	IEEEE 1394	Win98 SE	4.10.2222	PASS
	PCI	INTEL PILA8470B	Win98 SE	4.10.2222	PASS
	PCI	PC TEL789T-A	Win98 SE	7.66-9K-03	PASS
	PCI	ACORP BTB878	Win98 SE	4.1.8.8	PASS
All PCI/ISA Device Card	PCI	CREATIVE SB LIVE 5.1	Win XP	5.1.2535.0	PASS
	PCI	3COM3C905C-TX	Win XP	4.5.0.0	PASS
	PCI	PC TEL789T-A	Win XP	8.0.11.3	PASS
	PCI	ACHIP AEC-6712TU	Win XP	5.1.2600.0	PASS
	PCI	IEEE1394(582V2)	Win XP	5.1.2535.0	PASS
	PCI	DC-390U3W	Win XP	5.12.2600.0	PASS

Device Model	Slot	Vendor Model	O.S.	Driver Version	Result
LAN Card	PCI	INTEL PILA8470B	WIN98SE	4.10.2222	PASS
	PCI	3COM3C905C-TX	WINXP	4.5.0.0	PASS
SCSI Card	PCI	AHA2940UW	WIN98SE	V2.21a	PASS
	PCI	ACHIP AEC-6712TU	WINXP	5.1.2600.0	PASS
	PCI	DC-390U3W	WINXP	5.12.2600.0	PASS
TV / FM Capture Card	PCI	ACORP BTB878	WIN98SE	4.1.8.8	PASS
Sound Card	PCI	YAMAHA 724	WIN98SE	4.00.1020	PASS
	PCI	CREATIVE SB LIVE 5.1	WINXP	5.1.2535.0	PASS
VGA Card	PCI	S3 VIRGE-DX/GX PCI(375/385)	WIN98SE	4.10.1681	PASS
	PCI	S3 VIRGE-DX/GX	WINXP	5.1.2535.0	PASS
MODEM Card	PCI	PC TEL 789T-A	WIN98SE	7.66-9K-03	PASS
	PCI	PC TEL 789T-A	WINXP	8.0.11.3	PASS
USB 2.0 Card	PCI	NEC USB2.0(D72010GH)	WIN98SE	1.0.0.0	PASS
	PCI	NEC USB2.0 (D72010GH)	WINXP	5.1.2600.0	PASS
IEEE1394 Card	PCI	IEEEE 1394	WIN98SE	4.10.22222	PASS
	PCI	IEEEE 1394(582V2)	WINXP	5.1.2535.0	PASS
IEEE1394 Device	VENUS SERIES 3.5" STORAGE ENCLOSURE		WIN98SE		PASS

4D845A System Compatibility Test Report

D. Other Peripherals Compatibility Test

Device Model	Windows 98SE	Windows ME	Windows 2000	Windows XP
Mouse	MICROSOFT PN X05-51692			
Modem	SYNNEX MD-56KVC-2			
Print	EPSON STYLUS COLOR 740			
PS/2 Mouse	MICROSOFT PN X05-51692	MICROSOFT PN X05-51692	MICROSOFT PN X05-51692	
PS/2 Keyboard	LEMEL 5201	LEMEL 5201	LEMEL 5201	
USB Mouse	MICROSOFT OPTICAL MOUSE			
USB Keyboard	GENUINE K371			
USB Modem	ACORP HCF 56K MODEM			
USB Print	EPSON STYLUS COLOR 740			
USB ZIP	IOMEGA Z100			
USB SCANNER	UMAX ASTRA 3400	UMAX ASTRA 3400	UMAX ASTRA 3400	UMAX ASTRA 3400
USB Joystick	MICROSOFT SIDE WINDER P&P GAMEPAD			
USB Digital COMERA	FUJIFILM FINEPIX 2400 ZOOM		FUJIFILM FINEPIX 2400 ZOOM	FUJIFILM FINEPIX 2400 ZOOM