

Konica

1312 Copier



Powered by

Aleck Kholopov

Slash, Ltd

☎ 095 201 48 20

🌐 <http://www.slash.ru>

✉ slash@slash.ru

User's Manual

Konica

1312 Copier

Welcome to the Konica 1312 Copier.

To learn how to operate your copier safely and correctly, read all Safety information in Chapter 1 before attempting to operate your machine.

To benefit fully from the features and functions of the 1312 Copier, read through this manual. Should you require product information not covered in this manual, contact your Konica service representative.

User's Manual

MAINTENANCE AGREEMENT

The KONICA 1312 Copier will give you many years of trouble-free service. To ensure high quality copying performance and to prevent premature wear and failure of precision parts and components, periodic cleaning and routine adjustments should be scheduled.

We recommend that you contact your service representative to discuss the benefits and advantages of Konica's Customer Service Maintenance Agreement and to be shown how a maintenance plan can be tailored to your individual copying needs.

NOTICE:

Konica Business Technologies, Inc. has made every effort to ensure that the information in this manual is complete and accurate. However, constant efforts are also being made to improve and update the product. Therefore, Konica Business Technologies, Inc. shall not be liable for errors in this manual or for any consequential damages resulting from the use of this manual. The information contained herein is subject to change without notice.

FEDERAL OR STATE STATUTES MAY PROHIBIT THE COPYING OF CERTAIN DOCUMENTS OR INFORMATION, RESULTING IN FINES OR IMPRISONMENT FOR VIOLATORS.

MANUAL PART NUMBER: OP-01-1312

WEB SITE ADDRESS: <http://www.konicabt.com>

CORRESPONDENCE:

Correspondence regarding this manual may be mailed to the address shown below.

Konica Business Technologies, Inc.
Digital Systems Solutions Group
& New Product Development
500 Day Hill Road
Windsor, CT 06095
Tel. (860) 683-2222

Powered by
Aleck Kholopov
Slash, Ltd
☎ 095 201 48 20
★ <http://www.slash.ru>
✉ slash@slash.ru

About the International ENERGY STAR® Program

The purpose of the International ENERGY STAR Program is to protect the quality of the global environment through the efficient use of electric power that is generated chiefly by fossil fuels.

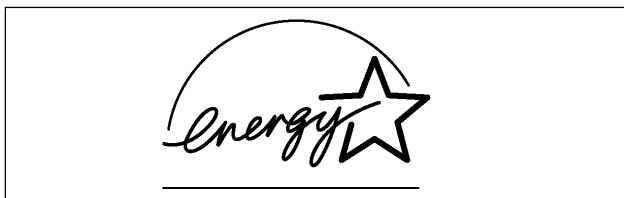

The Konica 1312 copier conforms to the International ENERGY STAR Program when used with the following Power Save function.

Power Save function

The Power Save function saves energy by reducing power consumption of the fixing unit below 5W. To accomplish this, Power Save puts the copier in the *sleep* state. The Power Save function automatically activates the sleep state if the copier is inactive for 30 minutes initially, or you can choose another sleep state, as desired, from 2, 5, 30, 60, 120, or 240 minutes. If you wish to make changes to the Power Save function, contact your Konica service representative.

Powered by
Aleck Kholopov
Slash, Ltd
☎ 095 201 48 20
★ <http://www.slash.ru>
✉ slash@slash.ru

NOTICE TO USERS IN THE USA

FCC Regulations

NOTICE: The Konica 1312 copier generates, uses, and can radiate radio frequency energy. If it is not installed and used in accordance with the instruction manual, interference with radio communications may result. This equipment has been tested and found to comply with the limits for a class B computing device, pursuant to Subpart J, Part 15, of FCC rules, which are designed to provide reasonable protection against interference from such equipment when it is operating in a commercial environment.

Users operating this equipment in a residential area are likely to cause interference, in which case they may be required to correct the interference at their own expense.

NOTICE TO USERS IN CANADA

Canadian Department of Communications Regulations

This Class B digital apparatus complies with Canadian ICES-003.

Cet appareil numérique de la classe B est conforme à la norme NMB-003 du Canada.

Powered by
Alek Kholopov
Slash, Ltd
☎ 095 201 48 20
★ <http://www.slash.ru>
✉ slash@slash.ru

CONTENTS

Chapter 1

Installation, transportation, handling

Machine Labels	1-2
Label Locations	1-2
High-Temperature Caution Label	1-3
High-Voltage Caution Label	1-3
Safety Information	1-4
Warnings	1-5
Cautions	1-5
Locating the Equipment	1-7
Handling the Copier & Supplies	1-8
Transporting the Copier	1-9
Recommended Site Requirements	1-10

Chapter 2

Preparations before using the copier

Removing Protective Packing Materials	2-2
Preparing Drum Unit & Developing Unit	2-4
Adding Toner	2-7
Enforced Replenishment of Toner	2-7
Add Toner Indication	2-7
Paper & Tray Information	2-10
Tray Specifications	2-10
Installing the Paper Exit Tray	2-10
Storing Paper	2-11
Paper Curl	2-11
Paper Orientation	2-11
Adding Paper	2-12
Add Paper Indication	2-12
Standard & Option Trays	2-13
Paper in the Manual Feed Bypass Tray	2-15
Turning the Power On	2-16
Initializing the Developer Unit	2-17
Initializing the Paper Size	2-19

Chapter 3

Hardware parts & functions

Main Body	3-2
Exterior View	3-2
Interior View	3-3

Chapter 4

Making copies

How to Make a Basic Copy	4-2
Using The Manual Feed Bypass Tray	4-4
Preset Mode	4-5
Zoom Mode	4-6
Features	4-7
Auto Clear Function	4-7
Power Save Mode	4-7
Copy Counter	4-7
Function Settings	4-8
Setting Paper Size	4-8
Setting Auto Clear Function	4-8
Initialize Drum/Developer Unit	4-8
Setting Automatic Check of Paper Length	4-8
Setting Procedure	4-8
Function Codes	4-10
How To Read The Copy Counter	4-11

Chapter 5

Maintenance

Supplies	5-2
Toner Cartridge	5-2
Drum Unit	5-2
Developing Unit	5-2
Spare Parts Availability	5-2
Package Contents	5-2
Daily Maintenance	5-3
Cleaning the Platen Glass and Paten Cover	5-3
Cleaning the Paper Carrier	5-3
Adding Toner & Replacing the Cleaning Pad	5-4
Adding Toner	5-4
Replacing the Cleaning Pad	5-4
Replacing the Drum Unit	5-6
Replacing the Developing Unit	5-10
Cleaning the Corona Wire	5-13

Chapter 6

Troubleshooting

Copy Quality	6-2
Error Codes & Remedies	6-4
J Code	6-4
P Code	6-6
F Code	6-8

Chapter 7

Specifications

Specifications	7-2
----------------------	-----

Index

Chapter 1

Installation, transportation, handling

Read this chapter before attempting to use this equipment. If you have any concerns about safety matters not addressed in this manual, be sure to contact your Konica service representative for advice.

Machine Labels	1-2
Label Locations	1-2
High-Temperature Caution Label	1-3
High-Voltage Caution Label	1-3
Safety Information	1-4
Warnings	1-5
Cautions	1-5
Locating the Equipment	1-7
Handling the Copier & Supplies	1-8
Transporting the Copier	1-9
Recommended Site Requirements	1-10

Machine Labels

Read this chapter before attempting to use this equipment. If you have any concerns about safety matters not addressed in this manual, be sure to contact your Konica service representative for advice.

Label Locations

This copier bears safety caution labels in the locations shown below. When using this product, use every precaution to avoid burns to your body, electrical shocks, or other personal injuries.

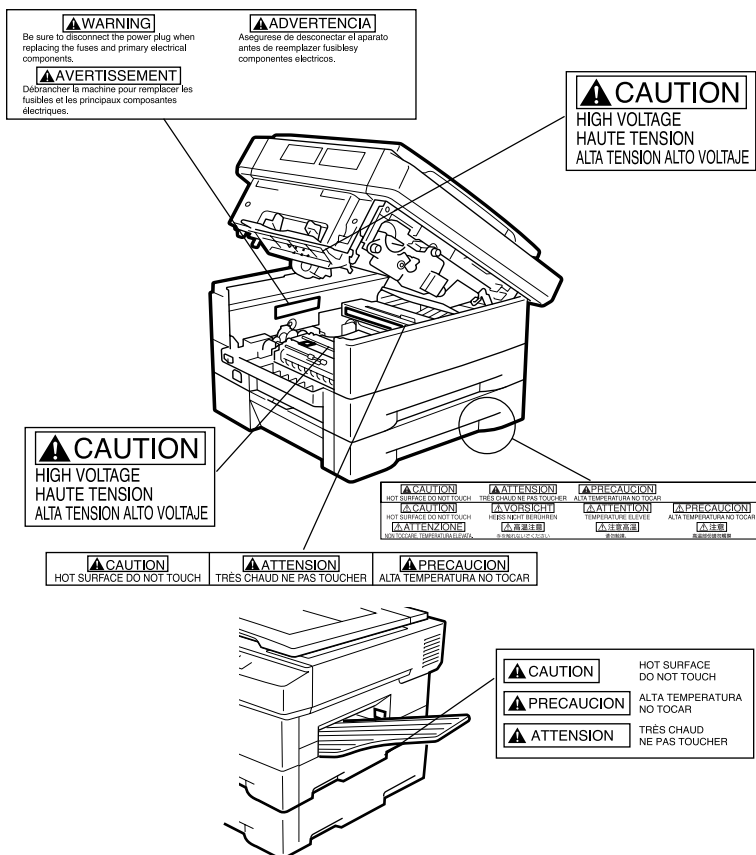

Machine Labels (continued)

■ High-Temperature Caution Label

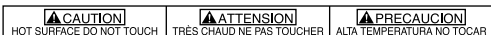
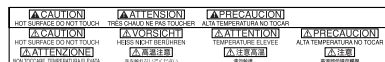
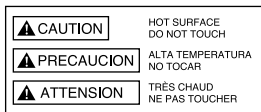

To avoid getting burned, DO NOT touch any portion of the copier that bears this label. These areas become very hot during copier use.

■ High-Voltage Caution Label

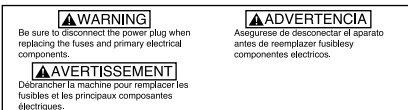

To avoid an electrical shock to your body, DO NOT touch any portion of the copier that bears this label. High voltage is applied to such areas during copier use.

CAUTION:

Never remove any caution labels. These labels are affixed to the equipment for your own protection, warning you against touching hot or electrically charged areas of the machine. The absence of a caution label might cause you or someone else to touch one of these parts by mistake and result in an accident from a burn or a shock. If any caution label is missing or becomes illegible from soilage, contact your Konica service representative.

Safety Information

Be sure to read the safety information contained in this manual and heed the safety labels attached to the copier.

Labels are categorized as **WARNING** or **CAUTION** to help you avoid hazardous conditions to your person and prevent property damage. Labels found on this equipment are defined below.



WARNING

WARNING indicates a potentially hazardous situation that could result in death or serious injury.

See the next page for a list of Warnings that should be heeded at all times.



CAUTION

CAUTION indicates a potentially hazardous situation that may result in minor or moderate injury or cause accidents resulting in property damage.

See page 1-6 for a list of Cautions that should be heeded at all times.

Safety Information (continued)

■ Warning - To Prevent Fire and Electrical Shock

- Do not expose the high-voltage area inside the copier by removing the rear cover or any other cover from the copier.

■ Cautions - To Prevent Fire and Electrical Shock

- Do not operate the copier on a voltage other than the voltage stated. Be sure the copier does not share the same wall outlet with other electrical equipment.
- Do not place any liquid-filled vessel or metal on the copier. Should any foreign matter (metal chips or water or other liquid) enter the copier, immediately disconnect the power plug and contact your Konica service representative.
- Do not scratch, damage, or modify the power cord. Never place any heavy item on the power cord or tug it or forcibly bend it.
- Do not modify the copier in any way or attempt to repair it yourself. Always contact your Konica service representative for help.
- If the copier emits smoke, abnormal odor, or is unduly heated, immediately stop using it, disconnect the power plug from the wall outlet and contact your Konica service representative.
- If the copier is damaged in any way, disconnect the power plug and contact your Konica service representative.
- Do not connect, disconnect or touch the power plug while your hands are wet; and do not allow an infant's mouth to come in contact with the power cord.
- Do not disconnect the power cord from the copier while the plug is connected to the wall outlet.
- Do not throw the toner cartridge developing unit, or drum unit into a fire, as the contents may blaze and cause burns.

Safety Information (continued)

■ Cautions - To prevent Fire and Electrical Shock (continued)

- When closing the left side of the upper unit, press down evenly on both corners of the left side and close the unit slowly to avoid injury to your fingers or damage to the copier.
- Avoid exposing the copier to humidity or dust.
- When using the copier in a small room for extended periods of time, use care to provide adequate ventilation.
- Never tug the power cord as a means to disconnect the plug, and always disconnect the power cord from the wall outlet before moving the copier; otherwise, the cord may become damaged. Never use the copier when the cord is damaged.
- Do not cover the copier vent openings; otherwise, heat will become trapped inside the copier.
- Avoid placing any heavy object on the copier that may interfere with normal copier use or be likely to topple or fall.
- When power is turned ON, the fixing unit becomes extremely hot. When replacing the drum unit or performing other maintenance tasks, do not touch any high temperature area.
- When transporting the copier, grasp and lift the copier only in the areas designated for lifting; otherwise, the main unit may fall or break and cause an accident.
- When opening or closing any copier component, hold only the specified areas; otherwise, your fingers may be injured.

Safety Information (continued)

■ Locating the Equipment

- Place equipment horizontally on a stable surface that does not shake or vibrate in any way.
- Keep this equipment away from direct sunlight; otherwise plastic parts may become deformed or discolored.
- To avoid risk of fire or electric shock, keep this equipment away from water. If water inadvertently enters the equipment, immediately unplug the AC power cord and contact your Konica service representative for assistance.
- Maintain a temperature range of 10~30°C (50~86°F) and a humidity range of 30~80% RH in the room where the equipment is placed. High temperature or high humidity can adversely affect paper and cause deterioration in print quality.
- Choose a location with a minimum amount of dust; otherwise, dust entering the equipment may degrade image quality or cause severe equipment malfunctions and physical damage.
- Keep other electrical appliances (television, radio, etc.) away from the equipment, as electromagnetic noise can cause a deterioration in performance.
- Do not remove any screws (unless otherwise instructed) or open the equipment case itself.
- Be sure the socket outlet is installed near the equipment and is easily accessible. To prevent electrical shock or fire, be sure the power cable remains free from any crimping.

Safety Information (continued)

■ Handling the Copier & Supplies

- ❑ When a heater is used in a cool room to generate heat quickly, condensation may form inside the copier housing and cause paper jams or other operation problems. In this case, turn on the equipment and wait before using the copier until the temperature inside the housing increases sufficiently to evaporate the moisture.
- ❑ Keep the equipment case and control panel clean by wiping away soil marks with a soft cloth dampened with a mild synthetic detergent. Never use any volatile chemical cleaners, which can cause discoloration or deformation of plastic parts.
- ❑ Exposing the photosensitive drum in the drum unit to direct sunlight will cause deterioration in print quality. Do not place the photosensitive drum outside the main unit for a period longer than 5 minutes and never touch the drum surface.

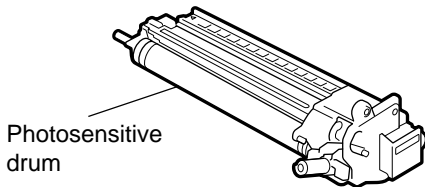

- ❑ Do not touch the developing roller in the developing unit; otherwise your hands may become soiled. Soil on your hands may be transferred to the paper and cause deterioration in print quality.

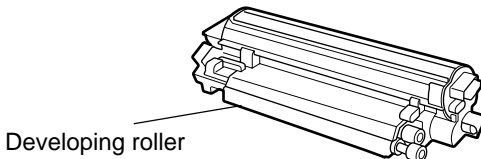

- ❑ Do not place the drum or developing unit in an upright position or turn it upside down; otherwise the photosensitive drum surface may be scratched or the toner may spill.

Safety Information (continued)

■ Transporting the Copier

- When transporting the copier for relocation, first remove components from the copier listed below, then pack the main body and all components using the packing materials and boxes supplied at the time of purchase; or use similar containers, if original packing materials are not available.

Wrap up the developing and drum unit in aluminium packing materials before placing them in packing boxes.

- Developing unit
- Drum unit
- Power cord
- Paper exit tray

- The main body should be lifted and carried by two persons. One person should support the bottom front area and the other person should support both sides of the rear area.

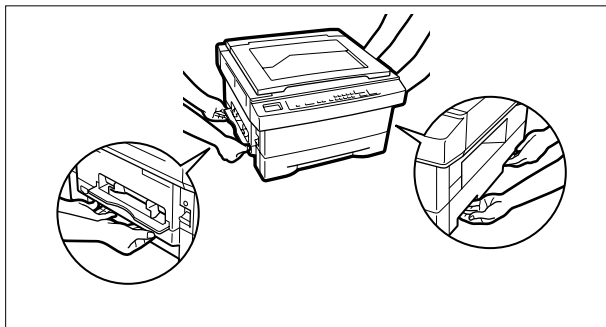

- Do not dispose of the copier yourself. Contact your Konica service representative.

Recommended Site Requirements

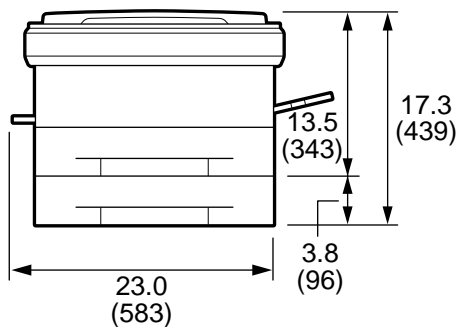
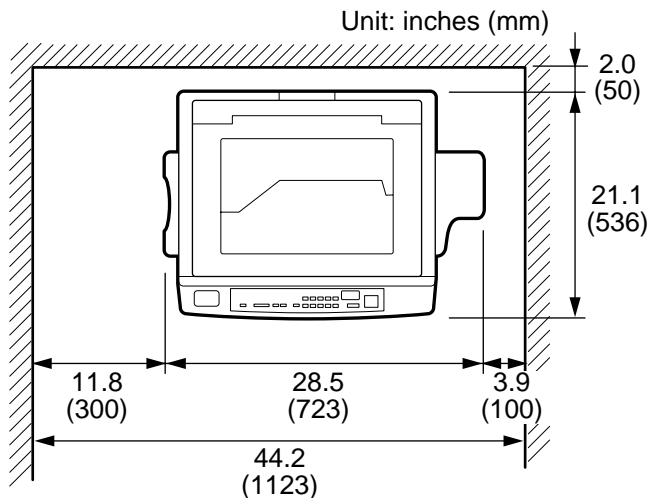

NOTE:

Dimensions placed within parentheses indicate where the option tray feeder is installed.

Chapter 2

Preparations before using the copier

The copier comes packed with protective materials to protect it from damage during transportation. Be sure to remove all of the protective packing material before installing the copier, and store the material in a convenient location for future use.

Removing Protective Packing Materials	2-2
Preparing Drum Unit & Developing Unit	2-4
Adding Toner	2-7
Enforced Replenishment of Toner	2-7
Add Toner Indication	2-7
Paper & Tray Information	2-10
Tray Specifications	2-10
Installing the Paper Exit Tray	2-10
Storing Paper	2-11
Paper Curl	2-11
Paper Orientation	2-11
Adding Paper	2-12
Add Paper Indication	2-12
Standard & Option Trays	2-13
Paper in the Manual Feed Bypass Tray	2-15
Turning the Power On	2-16
Initializing the Developing Unit	2-17
Initializing the Paper Size	2-19

Removing Protective Packing Materials

The copier comes packed with protective materials to protect it from damage during transportation. Be sure to remove all of the protective packing material before installing the copier, and store the material in a convenient location for future use.

1. Remove the four protective materials from the four corners of the platen cover.

Three (3) screws secure the optical unit.

2. Remove two of the screws from the left and right sides of the upper cover.

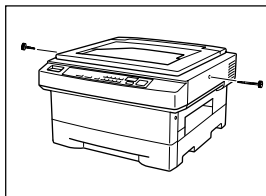

3. While holding the upper unit with one hand, press the upper unit release button to open the unit. Remove the mat from the manual feed bypass tray.

NOTES:

- Use care to prevent the upper unit from popping up.
- Open the upper unit until it clicks.

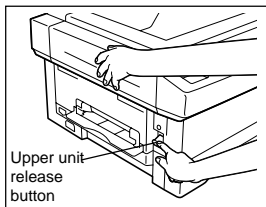

4. Remove the screw from the drum unit fixing area.

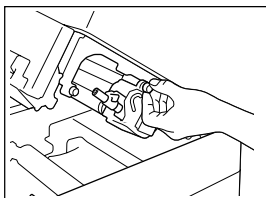

5. Pull out the drum unit.

NOTES:

- Do not touch the drum surface. Touching the drum may mark or scratch it.
- Do not expose the drum unit to light for longer than 5 minutes.

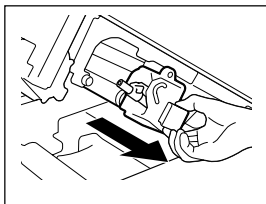

Removing Protective Packing Materials (continued)

6. Remove one screw with the red tag from the bottom side of the upper unit.

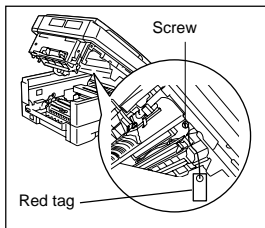

7. Reinstall the drum unit in the main body.

NOTE:

Align the blue mark on the drum unit with that on the main body, when reinstalling the drum unit.

8. Secure the drum unit with the drum unit fixing screw.

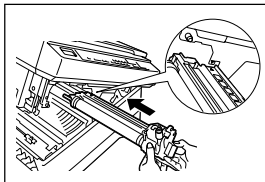

9. Remove the two protective materials from both ends of the transfer roller inside the main body.

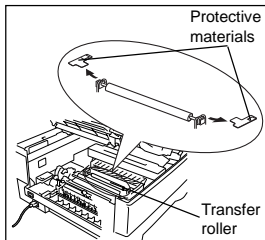

10. Remove the protective material from the paper tray, then lift the tray slightly and pull it out toward you.

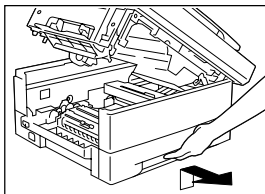

Packing material in the main body tray.

11. Remove the protective material from inside the tray, while moving Paper Guide [1] outward.
12. Push the tray into the copier until it clicks into place inside the main body.

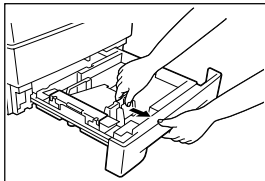

After removing the protective materials, prepare the drum unit and developing unit. Proceed to p. 2-4 to p. 2-6.

Preparing Drum Unit & Developing Unit

When installing the copier, prepare the drum unit and developing unit as described below.

NOTE:

DO NOT insert the drum unit into the main body when not installing the developing unit; otherwise the drum may be damaged.

1. If the upper unit of the main body is not open, open it according to step 2 of p. 2-2.

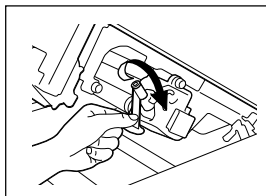

2. Remove the shield tape from the recycle pipe of the drum unit.

3. Set the recycle pipe to the RELEASE position.

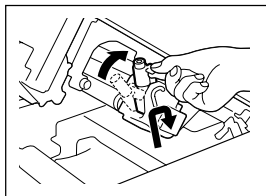

4. Unpack the developing unit.
5. Tip the developing unit with the gear side downwards, and shake it up and down about four or five times.
6. Then hold the developing unit in a level position and shake it from side to side four or five times.

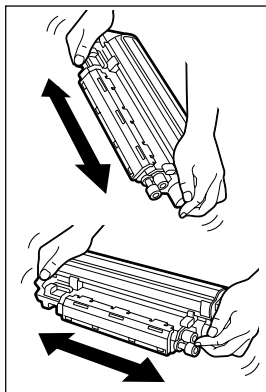

Preparing Drum Unit & Developing Unit (continued)

7. Remove the protective cover, then pull off the protective sheet and the mat in a downward direction.

NOTE:

It is not necessary to keep the protective cover, the protective sheet and the mat.

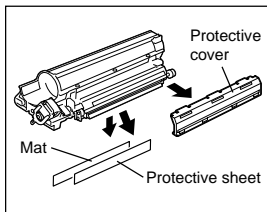

8. Peel the tape fixing the magnet tape, then carefully remove the magnetic tape by slipping it down slowly.

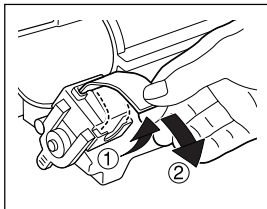

9. Remove the pipe cover.

NOTE:

To prevent developer from being scattered, remove it slowly.

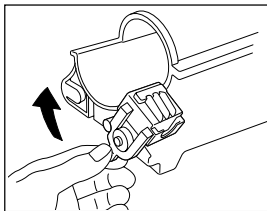

10. Remove the developing unit fixing screw.

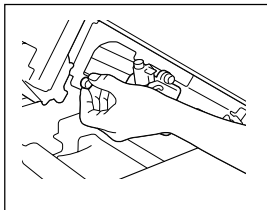

Preparing Drum Unit & Developing Unit (continued)

11. Insert the developing unit into the copier main body.

NOTE:

When reinstalling the developing unit, align the blue mark on the unit with the blue mark on the main body.

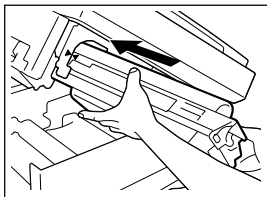

12. Secure the developing unit with the developing unit fixing screw.
13. Return the recycle pipe to the SET position.

After setting the developing unit correctly, replenish it with toner.
See p. 2-7 to p. 2-9.

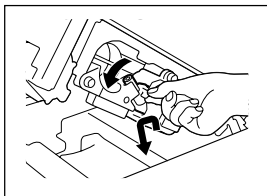

Adding Toner

This section describes the procedure for replenishing the drum unit with toner.



CAUTION:

Keep toner cartridge away from children. Although the toner is non-toxic, do not inhale it or allow it to enter your eyes. In case the toner comes in contact with eyes, please consult your physician.

■ Enforced Replenishment of Toner

When the toner supply of the developing unit temporarily becomes low while copying dark originals, the copier may stop just long enough to replenish the developing unit with toner. In this case, code [P25] displays and the Add Toner lamp blinks until replenishing is completed.

The toner supply is restored, and then copying starts automatically.

■ Add Toner Indication

When toner runs out, code [P25] flashes on the control panel in the Print quantity/Magnification ratio window and the Add Toner lamp blinks. Follow the steps below to replenish the developing unit with toner.

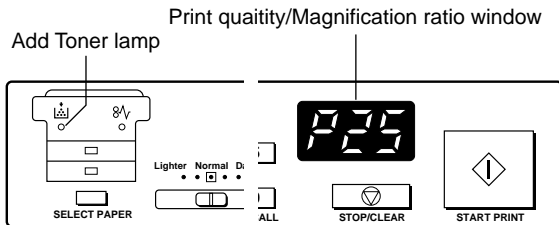

NOTE:

Use the toner cartridge specified for the machine. Using a toner cartridge of different type will cause copy quality problems.

Adding Toner (continued)

1. While holding the upper unit with one hand, press the upper unit release button to open the unit.

NOTES:

- Use care to prevent the upper unit from popping up.
- Open the upper unit until it clicks.

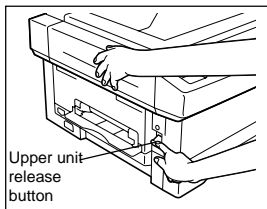

2. Turn the toner cartridge a little to both sides two or three times to empty any remaining toner into the developing unit.
3. Turn the toner cartridge 180° counterclockwise and pull it out.

NOTE:

Steps 2 and 3 are not required when you are initially setting the copier.

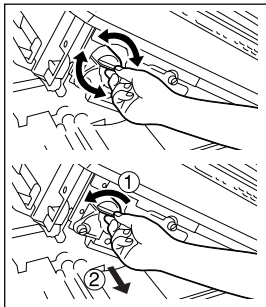

4. Before inserting the new cartridge, shake it from side to side four or five times.

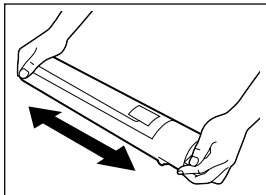

5. While removing the shield tape, insert the new toner cartridge into the developing unit.

NOTE:

Please insert the toner cartridge with shield tape side up.

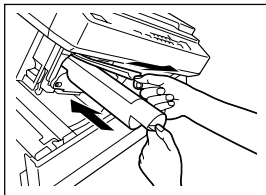

Adding Toner (continued)

6. Turn the toner cartridge 180°

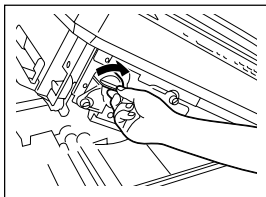

clockwise.

7. Close the upper unit by picking up the stopper lever while pushing up

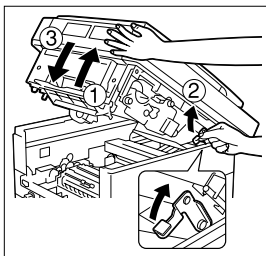

the upper unit slightly.

8. Close the upper unit securely, while holding it at each side.

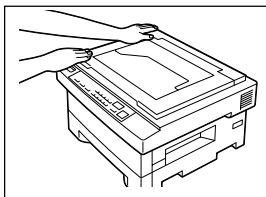

Paper & Tray Information

■ Tray Specifications

Main body tray: User-adjustable tray

Capacity	:250 sheets 20 lb
Paper size	:LG/LT/R/8"x13"/8.5"x13"/8.25"x13"
Copy paper weight	:16 lb~24 lb

Manual feed bypass tray

Capacity	:1
Paper size	: 5.5"x8.5"~LG
Copy paper weight	:16 lb~32 lb

Option tray: User-adjustable tray

Capacity	:250 sheets 20 lb
Paper size	:LT/R/LG/8"x13"/8.5"x13"/8.25"x13"
Copy paper weight	:16 lb~24 lb

■ Installing the Paper Exit Tray

Insert the receiving tray into the stopper of the main body and push it until it is fixed in place.

Tray capacity: 99 sheets

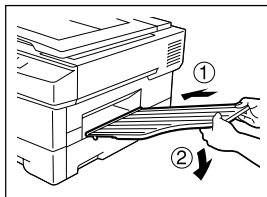

NOTE:

LG (Legal size 8.5"x14")

LT (vertical Letter size 8.5"x11")

R (horizontal Letter size 11"x8.5")

Paper & Tray Information (continued)

■ Storing Paper

If all the sheets from the newly opened package of copy paper cannot fit into the tray, wrap the remaining paper properly and store it in a darkened area that is cool, and dry. Using paper that was once exposed to dampness or wetness may cause deterioration of copy quality and paper feed efficiency.

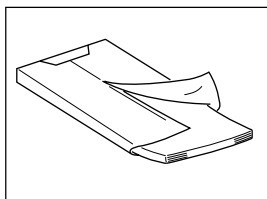

■ Paper Curl

Check to see the direction in which the stack of paper curls.

- *In the Tray*

Place paper in the user-adjustable tray with the curl upward.

- *In the Bypass*

Place paper in the manual feed bypass tray with the curl down.

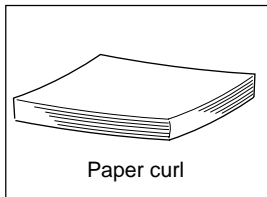

■ Paper Orientation

Paper orientation is sometimes described as portrait (vertical) or landscape (horizontal). This refers to the way paper is loaded in the feeder tray and output trays.



Portrait
(vertical)

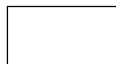

Landscape
(horizontal)

The Portrait and Landscape illustrations shown at the right refer to paper orientation as you face the copier.

Adding Paper

This section describes how to load paper in the main body tray or option tray and shows how to insert paper in the manual feed bypass tray.

■ Add Paper Indication

When copy paper is depleted, the remaining copy quantity displays in the Print quantity/Magnification ratio window for 90 seconds, and the Main Body Tray Selection lamp or Option Tray Selection lamp blinks.

After 90 seconds, the copier returns to the normal condition.

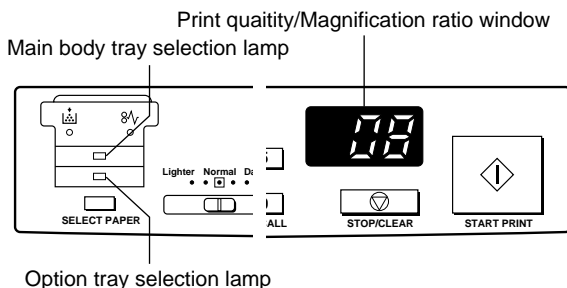

To replenish the tray with copy paper, use the procedure starting on the following page.

NOTE:

Never pull out a tray to replenish it with paper while copying is in process. Otherwise the copier will malfunction.

Adding Paper (continued)

■ Standard & Option Trays

Both the main body tray and the option tray are user-adjustable trays that can hold letter or legal paper sizes. To replenish the main body tray or option tray with paper, use the procedure below.

NOTE:

When turning on the power of the copier for the first time with paper loaded into the trays, the READY indicator may light in green, while the [SELECT PAPER] lamp is still off.

In this case, paper has already been fed into the internal area of the copier. Open the upper unit to remove it before making any copies, otherwise paper misfeed may occur.

1. Fan the copy paper to keep sheets from sticking together during copying.

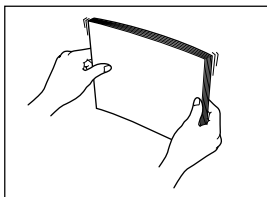

2. Lift the tray slightly and pull it out toward you.

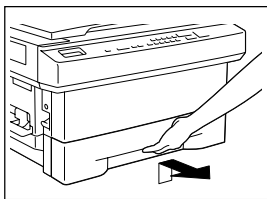

3. Push down the base plate.

NOTE:

Push down on the base plate until it is locked securely.

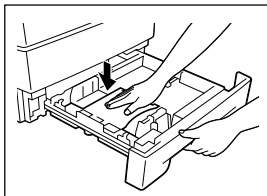

Adding Paper (continued)

■ Standard & Option Trays (continued)

4. Place copy paper in the tray.

NOTES:

- Place copy paper into the tray with curl side up.
- Be sure paper is stacked slightly below the hook level of the tray.
- The tray holds up to 250 sheets of 20 lb paper. Do not load paper above the upper paper guides.

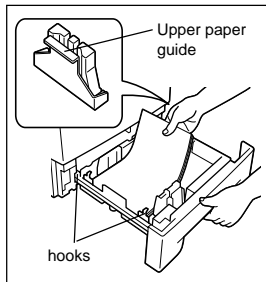

5. Adjust Paper Guide [1] to the paper size.

NOTE:

Use the guide knob to adjust the paper guide.

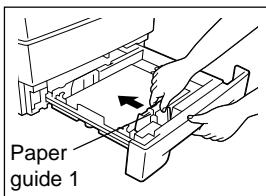

6. Adjust Paper Guide [2] to the paper size.

NOTE:

Use the guide knob to adjust the paper guide.

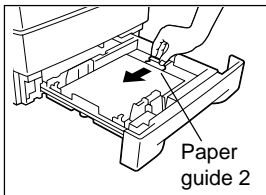

7. Remove the size label, then refold it so that the correct paper size will show when it is put back into the indicator window.

8. Push the tray into the copier until it clicks into place inside the main body.

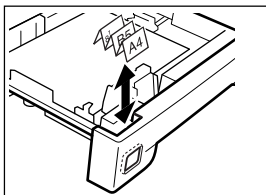

Adding Paper (continued)

■ Paper in the Manual Feed Bypass Tray

The manual feed bypass tray is used to feed non-standard size copy paper one sheet at a time. Use this convenient tray to copy labels, OHP transparencies, or irregular-sized sheets of paper.

Bypass paper size range: 8.5"x14"~5.5"x8.5"

Be sure paper is inserted with curl side down.

1. Insert one sheet of copy paper while adjusting the paper guide to the paper size.
2. Insert the paper until it touches the back end of the tray.

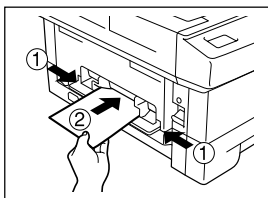

• *For two-sided copying:*

After copying the first side, insert the sheet again with the blank side facing up. Insert the sheet so that the page heading end of the sheet feeds last.

NOTE:

To prevent paper misfeeds, DO NOT insert wrinkled, curled or stapled paper into the manual feed bypass tray.

Turning the Power On

NOTE:

Before turning on the power to your Konica 1312 Copier for the first time check to be sure that the three screws used to fasten the optical unit and upper unit during transportation have been removed. (See p. 2-2).

If power is turned on with these screws installed, the copier will malfunction.

1. The power cord is packed with your copier. Connect one end of the power cord to the power supply connector located on the side of the copier next to the power switch.

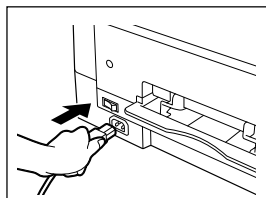

2. Then, insert the other end of the power cord plug into the wall outlet.

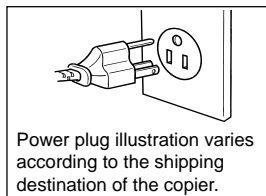

3. Turn the power switch ON.
When the copier is initially turned on, the code [P26] displays.
After preparing the drum unit and developing unit, and installing the toner cartridge, initialize the developing unit and paper size before using the copier for the first time.

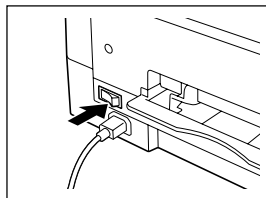

(See initializing procedures starting on the next page.)

Initializing the Developing Unit

Before using the copier for the first time after installation, you need to initialize the developing unit and set the paper size.

1. Press [SELECT PAPER] for five seconds.

All settings you made will clear and default settings will resume.

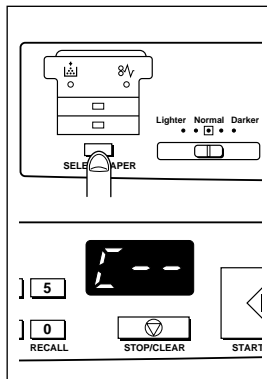

2. Use the keypad to enter [5] and [1].

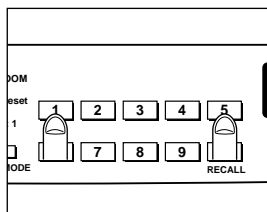

3. Press [START PRINT]. The value you enter will be displayed.

NOTE:

It takes about 6 minutes to initialize the developing unit.

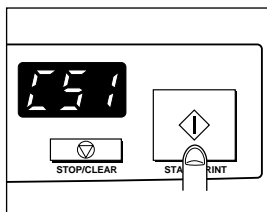

Initializing the Developing Unit (continued)

4. When initialization of the developing unit is completed, the code [C - -] displays on the control panel.
5. Press [STOP/CLEAR].
After pressing [STOP/CLEAR], [01] will be displayed.

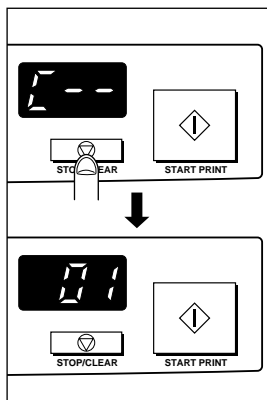

Initializing the Paper Size

Before using the copier for the first time after installation, you need to initialize the paper size.

1. Press [SELECT PAPER] for five seconds.

All settings you made will clear and default settings will be resumed.

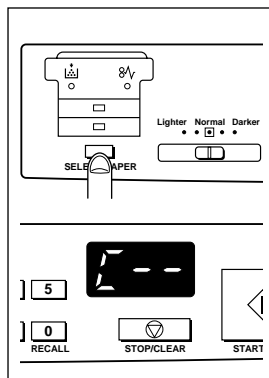

2. Use the keypad to enter the paper size code. Select the code from the table below.

LT (Letter)	C00
LG (Legal)	C01
A4	C02
B5	C03
A5	C04
F4-1: 8x13in. (203x30mm)	C05
F4-2: 8.5x13in. (216x330mm)	C06
F4-3: 8.25x13in. (210x330mm)	C07
F4-4: 206x337mm	C08

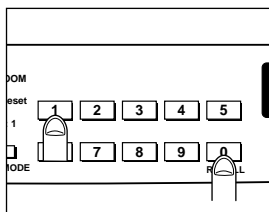

3. Press [START PRINT]. The entered value is established, and "C - -" will be displayed.

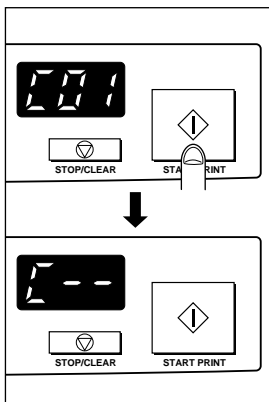

Initializing the Paper Size (continued)

4. Press [STOP/CLEAR].
At that time, [01] will be displayed indicating that initialization is successful and the machine is ready for copying.

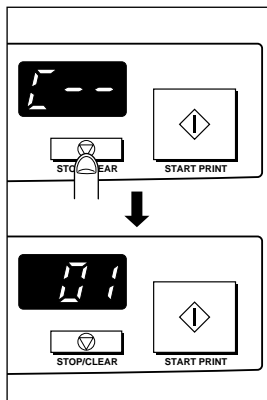

Chapter 3

Hardware Parts & Functions

This chapter identifies the external and internal parts and components of the copier and points out their locations.

Main Body	3-2
Exterior View	3-2
Interior View	3-3
Control Panel	3-4

Main Body

■ Exterior View

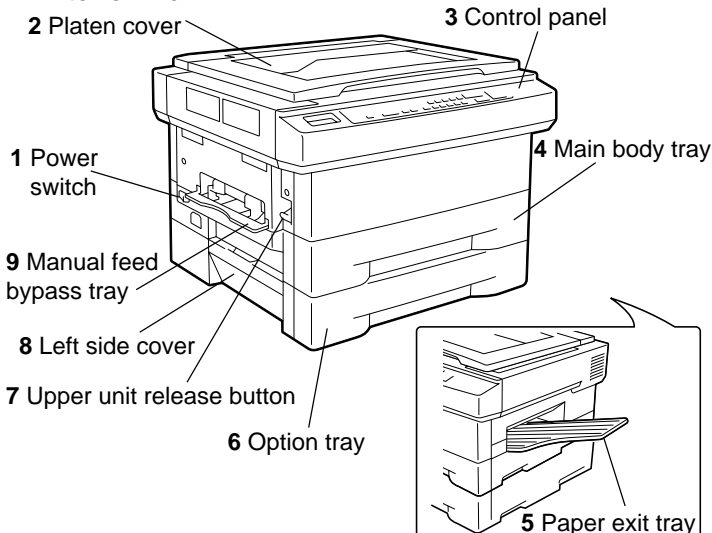

1. **Power switch** turns copier power on or off.
2. **Platen cover** covers documents to be copied and holds them in place.
3. **Control panel** controls copier settings & functions.
4. **Main body tray** is user-adjustable 250-sheet tray for various sizes (Letter/Legal).
5. **Paper exit tray** receives up to 99 output sheets.
6. **Option tray** is a third paper source functioning as a user-adjustable 250-sheet main body tray.
7. **Upper unit release button** opens the upper unit.
8. **Left side cover** opens to remove mishandled paper.
9. **Manual feed bypass tray** is a manual tray for feeding various sizes and stock, one sheet at a time (labels, OHP transparency film, etc.).

Main Body (continued)

■ Interior View

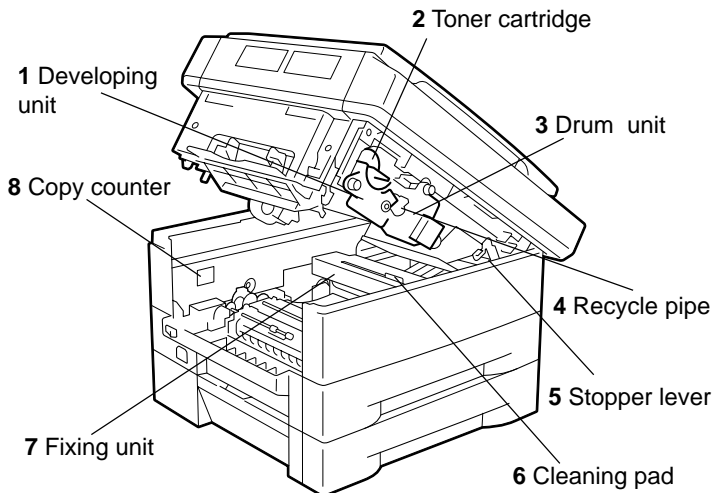

1. **Developing unit** prints images to the drum, and needs to be replaced periodically.
2. **Toner cartridge** is charged with toner, and needs to be replaced periodically.
3. **Drum unit** is electrically charged to form the copy image, and needs to be replaced periodically.
4. **Recycle pipe** returns toner in drum unit to the developing unit for reuse.
5. **Stopper lever** is moved to close and lock the upper unit.
6. **Cleaning pad** cleans the fixing roller, and needs to be replaced periodically.
7. **Fixing unit** is provided with a fixing roller to fix images (toner) to copy paper by heating up and applying pressure.

⚠ CAUTION:

To avoid getting burned, NEVER touch the fixing unit; its temperature rises very high when the copier is on.

8. **Copy counter** shows total number of copies made.

Control Panel

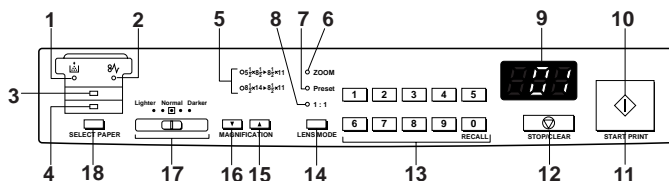

1. **Add Toner lamp** (blinking light) blinks when toner is running out.

When toner is low, the copier stops copying and automatically replenishes the drum unit with toner.

In this case, wait a minute until the replenishment of toner finishes.

2. **Paper monitoring lamp** (blinking light) blinks when copying paper is mishandled or no paper remains in the tray.

In this case, remove the mishandled paper or replenish the tray with paper.

3. **Main body tray selection lamp** (steady/blinking light) lights up when the main body tray is selected, and blinks when no copy paper is left.

4. **Option tray selection lamp** (steady/blinking light) lights up when the option tray is selected, and blinks when no copy paper is left.

5. **Preset magnification indicators** (steady light) lights up the preset reduction or enlargement magnification mode selected.

Control Panel (continued)

6. **Zoom mode lamp** (steady light) lights up when the zoom magnification mode is selected.
When lit, you can set a zoom magnification with the ▲(enlarge) or ▼(reduce) button.
7. **Preset magnification mode lamp** (steady light) lights up when the Preset Magnification mode is selected.
When lit, magnification is set with the ▲(enlarge) or ▼(reduce) button.
8. **One-to-one (1:1) mode lamp** (steady light) lights up when the 1:1 mode is selected. When lit, originals are copied in 1:1 without any magnification applied.
9. **Print quantity/Magnification ratio window** displays the number of copies and the copy magnification you set.
10. **READY indicator** lights up green when the copier is ready for copying. During warm-up or when the copier is not ready for copying, the orange lamp lights up.
When the copier is in the Power Save mode, the orange lamps blink.
11. **[START PRINT] button** can be pressed to begin copying while the READY indicator light is green. If you press this button during warm up, the copier returns to the copying-ready state, and then automatically starts to copy.
12. **[STOP/CLEAR] button** can be pressed during continuous copying to cancel the number of copies being made.

Control Panel (continued)

13. **Numeric keypad** selects the number of copies
14. **[LENS MODE] button** selects the desired lens mode, i.e., 1 : 1, Preset, or Zoom.

Each time the button is pressed, the lens mode cycles from 1 : 1 -> Preset -> Zoom -> 1: 1...

1 : 1: 1 to 1 mode effects no enlargement or reduction.

Zoom: Press the **[MAGNIFICATION]** buttons to select a Zoom ratio from 70%~141%.

Preset: Select a Preset ratio of 129% or 77%.

15. **[MAGNIFICATION ▲ (enlarge)] button** selects a Preset enlargement ratio or sets any Zoom mode ratio between 70 to 141%.
16. **[MAGNIFICATION ▼ (reduce)] button** selects a Preset reduction ratio or sets any Zoom mode ratio between 70 to 141%.
17. **[Copy density] control knob** controls copy density.

Slide the knob to the right to adjust exposure when originals are too light or slide the knob to the left to adjust for dark originals.

18. **[SELECT PAPER] button** selects a paper tray. (This button is used only when the option tray is installed in the copier.)

Chapter 4

Making Copies

Turn the page to see how to make a basic copy, or refer to remaining pages to select various copying functions required for special jobs. Read on to learn how easy it is to customize the Konica 1312 Copier to suit your particular work environment.

How to Make a Basic Copy	4-2
Using the Manual Feed Bypass Tray	4-4
Preset Mode	4-5
Zoom Mode	4-6
Features	4-7
Auto Clear Function	4-7
Power Save Mode	4-7
Copy Counter	4-7
Function Settings	4-8
Setting Paper Size	4-8
Setting Auto Clear Function	4-8
Initialize Drum/Developer Unit	4-8
Setting Automatic Check of Paper Length	4-8
Setting Procedure	4-8
Function Codes	4-10
Reading the Copy Counter	4-11

How to Make a Basic Copy

The following information describes how to make a basic copy without selecting any special features.

1. Turn on the power switch.
2. Open the platen cover.

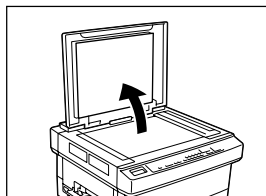

3. Place an original document face down on the platen glass and align the edge of the paper with the scale plate on the right.

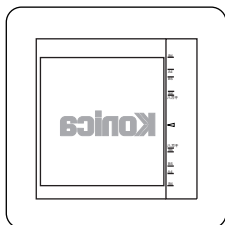
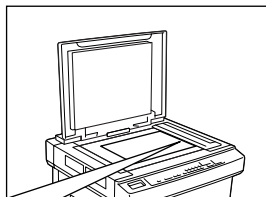

4. Select a paper tray by pressing [SELECT PAPER].

NOTE:

- If a sheet of paper is set in the manual feed bypass tray, priority is given to the manual feed bypass tray.
- If the option tray is not installed, skip this step and proceed as follows.

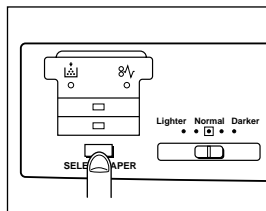

How to Make a Basic Copy (continued)

- Select the following copying conditions.

Select Copy density.

Set the control knob at the midpoint for normal density.
 Slide the knob to the right for darker copy image.
 Slide the knob to the left for lighter copy image.

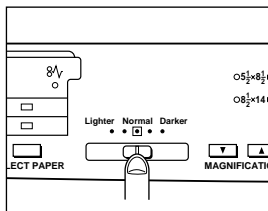

Select [1:1, PRESET, or ZOOM MODE].

Press [LENS MODE] to highlight [1:1].

Each time you press [LENS MODE], the mode cycles in the following order: 1 : 1 -> Preset -> Zoom -> 1 : 1 ...

To select a Preset or Zoom mode magnification ratio, see p. 4-5 or p. 4-6.

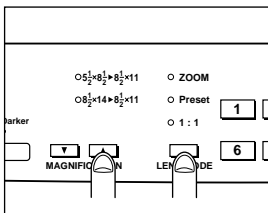

Select Print Quantity.

Use the keypad to select the desired number of copies.

To change the number of copies, press [STOP/CLEAR] and reset the print quantity.

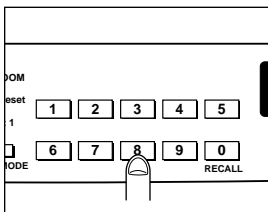

- Press [START PRINT].

Coping will begin.

To stop copying, press [STOP/CLEAR].

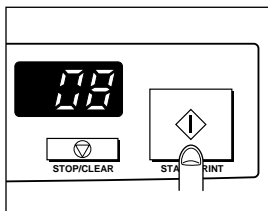

Using the Manual Feed Bypass Tray

Use the manual feed bypass tray to feed special copy paper that cannot be fed through the regular tray. After positioning the original document, manually feed one sheet at a time into the bypass.

The manual feed bypass tray can be used to manually feed an OHP transparency, a label sheet, Legal (8.5"x14"), Letter/R (8.5"x11"/R) and Invoice (5.5"x8.5"), from 16lb~32 lb.

NOTE:

To avoid a paper misfeed, DO NOT feed wrinkled or warped paper into the manual feed bypass tray.

1. Adjust the paper guides of the manual bypass tray to the width of the copy paper and insert the paper until it reaches the end.

- When paper is inserted, the bypass mode is selected automatically and the paper feeds into the copier by a roller.

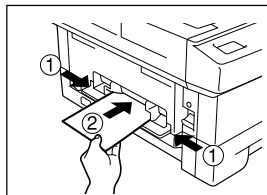

2. Select the conditions for copying.
See p. 4-3.
3. Press [START PRINT].
Copying will begin.

Preset Mode

Select the Preset mode to enlarge or reduce the photocopy image using a Preset magnification ratio.

The following procedure describes how to select a Preset magnification ratio after you have made all other copying selections and positioned the original document.

1. Press [LENS MODE] to select the Preset mode.

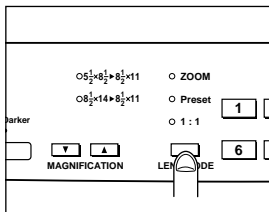

2. Press [MAGNIFICATION (▲) (▼)] to select the desired Preset ratio.

For Invoice to Letter, select 129%
5.5"x8.5" to 8.5"x11"

For Legal to Letter, select 77%
8.5"x14" to 8.5"x11"

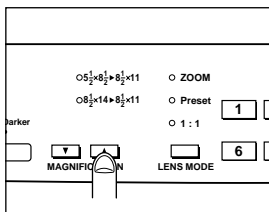

Zoom Mode

Select the Zoom mode to enlarge or reduce the photocopy image using a magnification ratio from 70%~141%. A Zoom ratio can be selected in increments of 1%.

The following procedure describes how to select a Zoom magnification ratio after you make all other copying selections, including positioning the original document.

1. Press [LENS MODE] to select the Zoom mode.

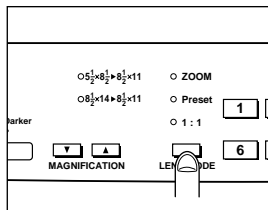

2. Either use the keypad to enter a Zoom ratio or press [MAGNIFICATION (▲) (▼)] to select the desired Zoom ratio.

Each time you press [▲ (enlarge)] or [▼ (reduce)], the magnification ratio changes in increments or decrements of 1%.

If you press [▲ (enlarge)] or [▼ (reduce)], the magnification ratio increases or decreases continuously.

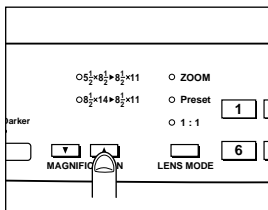

Features

The following information describes the special features of the Konica 1312 Copier.

■ Auto Clear Function

If no settings are entered on the control panel for a specified period of time, all previous settings will be cleared and default values shown below will be resumed automatically.

Default Settings

Print quantity	:	1
Copy magnification	:	1 : 1
Paper tray	:	Main body tray

NOTE:

You can change the elapse time of the Auto Clear function to 30, 60, 90, or 120 seconds. See p. 4-8 to p. 4-10.

■ Power Save Mode

If no command is entered on the control panel for a specific period of time, the temperature of the fixing unit will be lowered automatically to reduce power consumption. The Power Save feature will help you conserve energy.

In the Power Save mode, only the READY indicator is on and all other lamps are off. To return the copier to the READY mode, press any button on the control panel.

You can change the elapse time of the Power Save function to 2, 5, 30, 60, 120 or 240 minutes. Contact your Konica service representative if you wish to change Power Save settings. The default setting is 30 minutes.

■ Copy Counter

This feature allows you to view the total number of the copies made on the machine by displaying the amount in the Print quantity/Magnification ratio window (see procedure on p. 4-8 to p. 4-10).

Function Settings

Setting changes can be made for the four functions shown below. See function setting options and codes on p. 4-10.

■ Setting Paper Size

Change the paper size setting whenever you need to load a different size copy paper in a tray.

■ Setting Auto Clear Function

Set the time period for activating the auto clear function.

■ Initializing Drum/Developer

Initialize the drum every time you replace the drum unit.

Initialize the developing unit, when you install the copier initially and every time you replace the developing unit.

■ Setting Automatic Check of Paper Length

Set the automatic detection setting.

■ Setting Procedure

Before starting, be sure the copier is in the READY state.

1. Press [SELECT PAPER] for five seconds.

All settings previously made will be cleared and the copier default settings will be resumed.

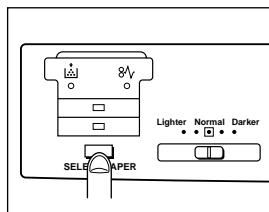

2. Referring to the table on p. 4-10, enter the desired code using the keypad.

Ex.: [2] [0]

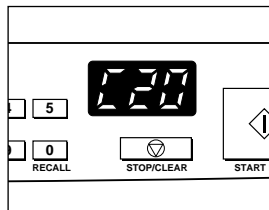

Function Settings (continued)

3. Press [START PRINT].
The value you entered will be defined.

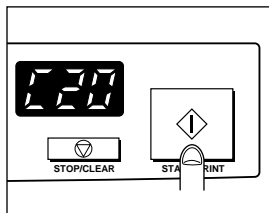

4. Press [STOP/CLEAR].
The copier will return to the READY state.

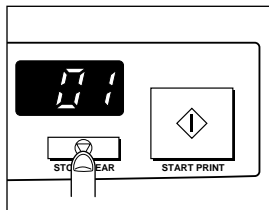

Function Codes

Paper Size Settings

Size of paper in Main body tray

- C-00 LT (letter)
- C-01 LG (legal)
- C-02 A4
- C-03 B5
- C-04 A5
- C-05 F4-1: 8"x13" (203x330mm)
- C-06 F4-2: 8.5"x13" (216x330mm)
- C-07 F4-3: 8.25"x13" (210x330mm)
- C-08 F4-4: 206x337mm

Size of paper in Option tray

- C-10 LT (letter)
- C-11 LG (legal)
- C-12 A4
- C-13 B5
- C-14 A5
- C-15 F4-1: 8"x13" (203x330mm)
- C-16 F4-2: 8.5"x13" (216x330mm)
- C-17 F4-3: 8.25"x13" (210x330mm)
- C-18 F4-4: 206x337mm

Auto Clear Elapse Settings (Default is underlined)

- C-20 30 sec.
- C-21 60 sec.
- C-22 90 sec.
- C-23 120 sec.

Copy Counter Reading

- C40 Read the main body copy count
- C41 Read the drum unit copy count
- C42 Read the developing unit copy count

Initialization: Initialize Drum Unit/Developing Unit

- C-50 Initialize the drum unit.
- C-51 Initialize the developing unit.

Paper Length: Automatic Paper Length Detection (Default is underlined)

- C-60 OFF
- C-61 ON
- C-62 ON (LT width erase)

Reading the Copy Counter

Display the number of copies made on the copier.

To read the total number, keep in mind that the first three digits of the number display first, then the last three digits display.

Before starting, be sure the copier is in the READY state.

1. Press [SELECT PAPER] for five seconds.

All settings previously made will be cleared and the default settings will be resumed.

(See default settings on p. 4-7.)

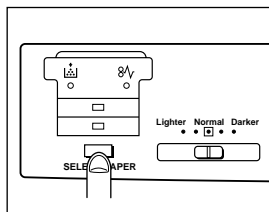

2. Use the keypad to enter [4] and [0], then the required value.

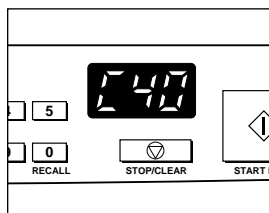

3. Press [START PRINT].

The first three digits of the number will be displayed for about three seconds.

Then, after a 1-second delay, the last three digits will be displayed.

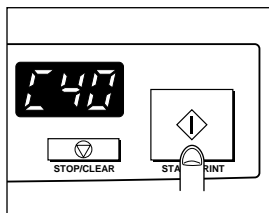

Ex. 1,900 copies

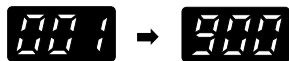

3 sec. 1 sec. 3 sec.

Reading the Copy Counter (continued)

4. Press [STOP/CLEAR].
The copier will return to the READY state.

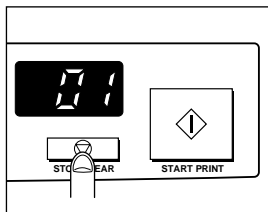

Chapter 5

Maintenance

To enjoy optimal performance from your Konica 1312 Copier, be sure to use only Konica brand supplies.

Perform maintenance on a daily basis and periodically replace consumables as recommended.

See Chapter 2 for instructions on Adding Paper.

Supplies	5-2
Toner Cartridge	5-2
Drum Unit	5-2
Developing Unit	5-2
Spare Parts Availability	5-2
Package Contents	5-2
Daily Maintenance	5-3
Cleaning the Platen Glass and Platen Cover ..	5-3
Cleaning the Paper Carrier	5-3
Adding Toner & Replacing the Cleaning Pad	5-4
Adding Toner	5-4
Replacing the Cleaning Pad	5-4
Replacing the Drum Unit	5-6
Replacing the Developing Unit	5-10
Cleaning the Corona Wire	5-13

Powered by

Aleck Kholopov

Slash, Ltd

☎ 095 201 48 20

★ <http://www.slash.ru>

✉ slash@slash.ru

Supplies

■ Toner Cartridge

Toner cartridge 1pc

Cleaning pad 1pc

■ Drum Unit

Drum unit 1pc

■ Developing Unit

Developing unit 1pc

■ Spare Parts Availability

Spare parts for this copier are available for at least 7 years after the discontinuance of the production of the model.

■ Package Contents

Drum unit (already installed in the main body) 1pc

Developing unit 1pc

Toner cartridge 1pc

Paper exit tray 1pc

Cleaning pad (already installed in the main body) .. 1pc

User's Manual 1pc

User's Service Guide 1pc

Warranty Registration 1pc

Limited Warranty Statement 1pc

Daily Maintenance

Soil marks on the platen glass or platen cover are likely to show up as black marks on your copies.

To obtain optimal copying performance and image quality, be sure to perform the following maintenance on a routine basis.



CAUTION:

Do not use any solvents, such as benzine and thinner.

■ Cleaning the Platen Glass and Platen Cover

Wipe the glass and the cover with a clean soft cloth.

If soil marks are difficult to remove, slightly moisten the cloth with water or alcohol.

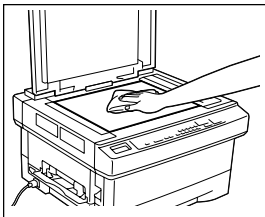

■ Cleaning the Paper Carrier

If the paper carrier becomes soiled, copy quality will be diminished.

To ensure optimal copy quality, clean the paper carrier on a routine basis using a clean soft cloth.

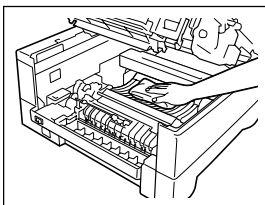

Adding Toner & Replacing the Cleaning Pad

When toner runs out, code [P25] displays in the Print quantity/ Magnification ratio window and the Add Toner lamp blinks.

In this case, replenish the developing unit with toner and also replace the cleaning pad.

■ Adding Toner

See p. 2-7 to p. 2-9.

■ Replacing the Cleaning Pad

1. While holding the upper unit with one hand, press the upper unit release button to open the unit.

NOTES:

- Use care to prevent the upper unit from popping up.
- Open the upper unit until it clicks.

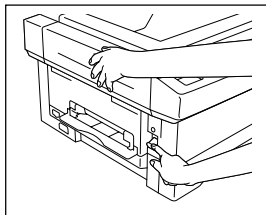

2. Slide the cleaning pad to the rear, then remove it while pulling up on the front side.

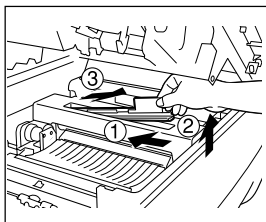

Adding Toner & Replacing the Cleaning Pad (continued)

3. Insert a new cleaning pad at the rear, then slide it to the front to install firmly.

NOTE:

After installing a new cleaning pad, pull it upward to check that it is firmly installed.

If not firmly installed, soiling of copy images and mishandled paper may occur.

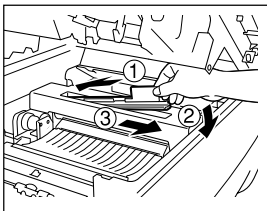

4. Close the upper unit by picking up the stopper lever while pushing up the upper unit slightly.

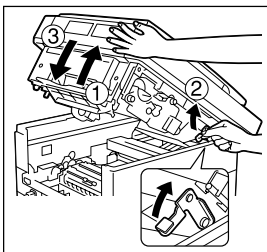

5. Close the upper unit securely, while holding it at each side.

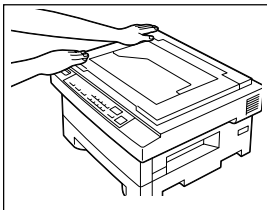

Replacing the Drum Unit

The drum unit has a life-span of approx. 25,000 copies.

When the life of the drum unit is near the end, code [P20] displays in the Print quantity/Magnification ratio window to let you know that approximately 500 additional copies can be made.

When the life of the drum unit actually reaches the end, code [P24] displays and further copying will not be possible. When code [P24] displays, replace the drum unit as shown below.

If necessary, contact your Konica service representative for supplies.

NOTES:

- Install the new drum unit, and then reinstall the developing unit; otherwise the drum may be damaged.
- Initialize the drum unit after installing it.
See p. 4-8 to p. 4-10.

1. While holding the upper unit with one hand, press the upper unit release button to open the unit.

NOTES:

- Use care to prevent the upper unit from popping up.
- Open the upper unit until it clicks.

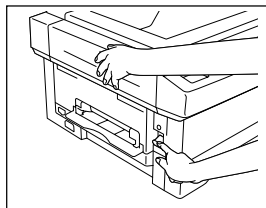

2. Remove the developing unit.
 - (1) Set the recycle pipe to the RELEASE position.

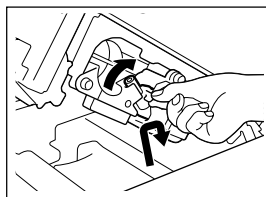

- (2) Remove the developing unit fixing screw.

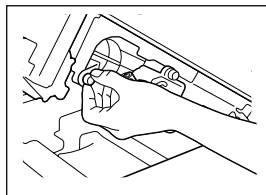

Replacing the Drum Unit (continued)

- (3) Slide the developing unit to the left, then pull it out.

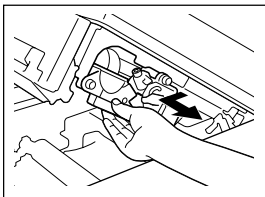

3. Remove the drum unit.
(1) Remove the drum unit fixing screw.

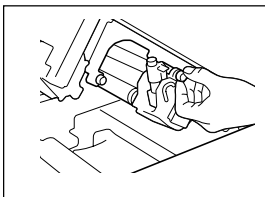

- (2) Pull out the drum unit.

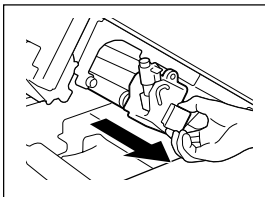

4. Install a new drum unit.
(1) Unpack a new drum unit.
(2) Insert a new drum unit into the main body.

NOTE:

Align the blue mark on the drum unit with that on the main body, when installing the drum unit.

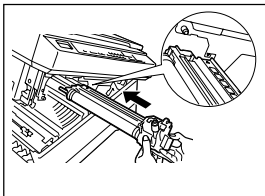

- (3) Secure the drum unit with the drum unit fixing screw.

Replacing the Drum Unit (continued)

- (4) Remove the shield tape from the recycle pipe of the drum unit.

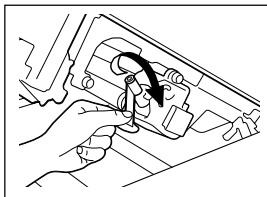

- (5) Move the recycle pipe to the RELEASE position.

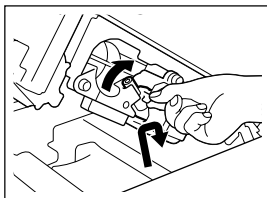

5. Reinstall the developing unit.

- (1) Insert the developing unit into the copier main body.

NOTE:

When reinstalling the drum unit, align the blue mark on the unit with the blue mark on the main body.

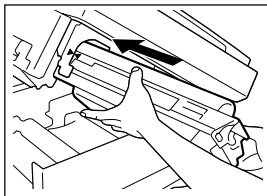

- (2) Secure the developing unit with the developing unit fixing screw.
(3) Return the recycle pipe to the SET position.

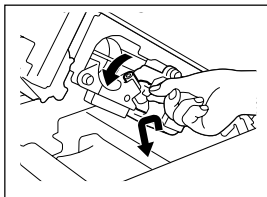

Replacing the Drum Unit (continued)

6. Close the upper unit by picking up the stopper lever while pushing up the upper unit slightly.

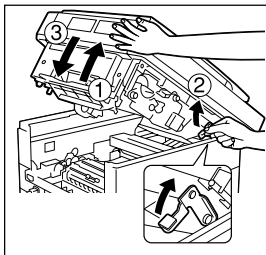

7. Close the upper unit securely, while holding it at each side.

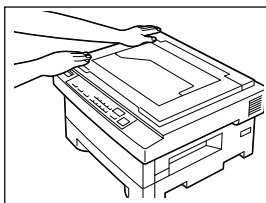

8. Initialize the drum unit according to the appropriate procedure. See p. 4-8 to p. 4-10.

Replacing the Developing Unit

The developing unit has a life-span of approx. 25,000 copies. When the life of the developing unit is near the end, code [P29] displays in the Print quantity/Magnification ratio window to let you know that approximately 500 additional copies can be made before the copier shuts down.

When the life of the developing unit is actually over, code [P29] displays and further coping will not be possible. When code [P29] appears, replace the developing unit as shown below.

If necessary, contact your Konica service representative for supplies.

NOTE:

After installing the developing unit, add toner, replace the felt cleaning pad and initialize the developing unit, in that order.

1. While holding the upper unit with one hand, press the upper unit release button to open the unit.

NOTES:

- Use care to prevent the upper unit from popping up.
- Open the upper unit until it clicks.

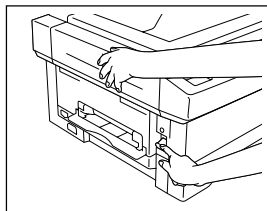

2. Remove the developing unit.
 - (1) Move the recycle pipe to the RELEASE position.

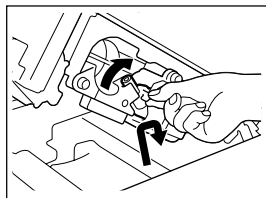

- (2) Remove the developing unit fixing screw.

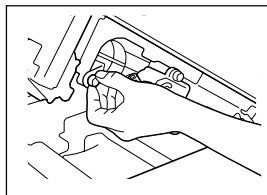

Replacing the Developing Unit (continued)

- (3) Slide the developing unit to the left, then pull it out.

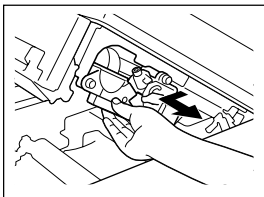

3. Install a new developing unit.
 - (1) Unpack a new developing unit.
 - (2) Tip the developing unit with the gear side downward, and shake it up and down about four or five times.
 - (3) Then hold the developing unit in a level position and shake it from side to side four or five times.

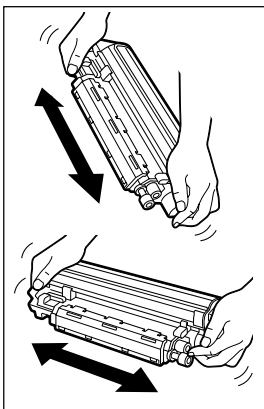

- (4) Remove the protective cover, then pull off the protective sheet and the mat in a downward direction.

NOTE:

It is not necessary to keep the protective cover, the protective sheet and the mat.

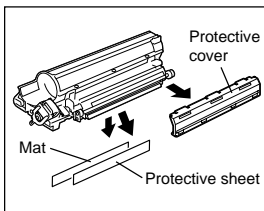

- (5) Peel the tape fixing the magnet tape, then carefully remove the magnetic tape by slipping it down slowly.

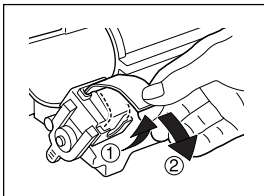

Replacing the Developing Unit (continued)

- (6) Remove the pipe cover.

NOTE:

To prevent developer from being scattered, remove it slowly.

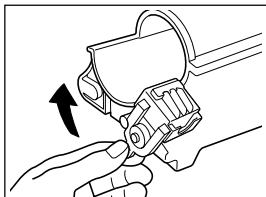

- (7) Insert the developing unit into the copier main body.

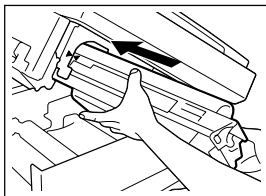

- (8) Secure the developing unit with the developing unit fixing screw.
(9) Return the recycle pipe to the SET position.

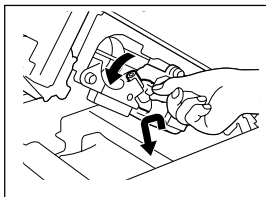

4. Replenish the developing unit with the toner. (See p. 2-7 to p. 2-9.)
5. Replace the felt cleaning pad. (See p. 5-4.)
6. Initialize the developing unit. (See p. 2-17 to p. 2-18.)

Cleaning the Corona Wire

If copies appear to be soiled, clean the corona wire. Use the wire cleaner provided in the main body tray to clean the wire. The corona wire is inside the drum unit slot.

NOTES:

- To be able to clean the corona wire, it is necessary to remove the drum unit and the developing unit from the main body. After cleaning the corona wire, reinstall the drum unit and the developing unit in that order; otherwise the drum may be damaged. See p. 5-6 to p. 5-12.
- Do not touch the drum surface. Touching the drum may mark or scratch it.
- Do not expose the drum unit to light for longer than 5 minutes.

1. Remove the drum unit from the main body.
2. Withdraw the main body tray and take out the wire cleaner.

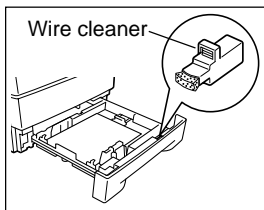

3. Insert the wire cleaner into the slot of the drum unit.

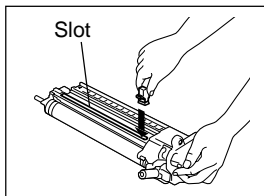

4. To clean the corona wire, slide the wire cleaner to the left and right four or five times.
5. Reinstall the drum unit and the developing unit in that order.

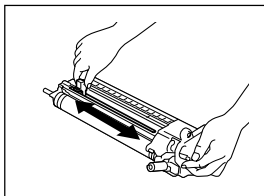

Chapter 6

Troubleshooting

In most cases you will be able to correct problems by following the troubleshooting advice in this chapter.

To prevent problems from occurring, read the information in this chapter to learn the various ways to care for your equipment.

Should you encounter a problem that cannot be resolved easily, contact your Konica service representative.

Copy Quality	6-2
Error Codes & Remedies	6-4
J Code	6-4
P Code	6-6
F Code	6-8

Copy Quality

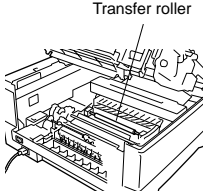
Problem	Cause	Remedy
<p>■ Copy image is too light.</p>	Copy density setting is not correct.	Adjust the copy density properly.
	<p>Toner supply is low.</p> <p>A large number of high-contrast copies are made continuously.</p>	Check to see if the Add Toner lamp is lit. If it is lit, replace the toner cartridge.
	Copy paper is damp or wet.	Replace the copy paper.
<p>■ Copy image is too dark</p>	Copy contrast setting is not correct.	Adjust the copy density properly.
<p>■ No image copied. Blank sheet is output.</p>	The developing unit is not set correctly.	Set the developing unit correctly.
<p>■ Back of copy is soiled.</p>	The transfer roller is soiled.	<p>Clean the roller with a dry cloth.</p> 
<p>■ Copies shows dark stripes in vertical direction.</p>	The cleaning pad life is over.	Replace the cleaning pad.

Copy Quality (continued)

Problem	Cause	Remedy
■ Dark parts are copied unevenly.	Copy paper being used is outside specifications.	Use one of the designated copy papers.
	Copy paper is damp or wet.	
■ Certain portions of the copy appear blank.	The edge of the copy paper is blank.	Set copy paper correctly.
	The copy paper is damp or wet.	Replace the copy paper.
	Copy paper used is not within specifications.	Use copy paper that is within specifications.
■ Similar soil marks appear on every copy.	The drum surface is scratched.	If the distance between soil marks on the copy is 94 mm, replace the drum unit.
■ Toner removes easily if the copy is rubbed.	Copy paper used is too thick or the surface is too slick.	Use copy paper that is within specifications.

NOTE:

If no improvement is detected on the copy quality after using the remedies shown above, contact your Konica service representative.

Error Codes & Remedies

This copier indicates error codes beginning with J, P, or F. When an error occurs, take appropriate measures according to the code indicated on the Print quantity/Magnification ratio window and the mishandled paper label on the platen cover.

J Code

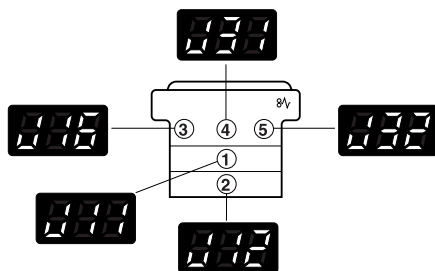

NOTES:

- Remove mishandled paper so that no torn paper remains inside the machine.
- Do not touch or damage the drum surface.
- When removing mishandled paper, be sure to follow the caution labels attached inside the machine to keep from getting burned or experiencing an electrical shock.

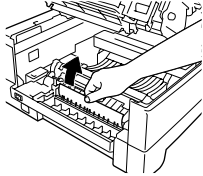
Error code	Meaning / Cause	Remedy
J11/16	Copy paper is mishandled in the paper feed area of the main body tray.	Withdraw the main body tray and remove the mishandled paper. 

Error Codes & Remedies (continued)**J Code (continued)**

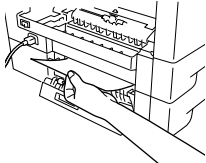
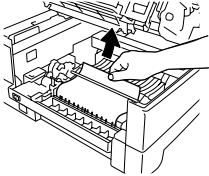
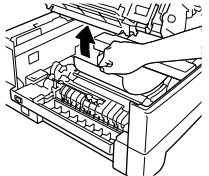
Error code	Meaning / Cause	Remedy
J12	Copy paper is mishandled in the paper feed area of the option tray.	Open the left side cover and remove the mishandled paper. 
J31	Copy paper is mishandled in the paper carrier.	Open the upper unit and remove the mishandled paper in the direction shown. 
J32	Copy paper is mishandled in the fixing unit.	Open the upper unit and remove the mishandled paper. 

Error Codes & Remedies (continued)

P Code

Error code	Meaning / Cause	Remedy
P11(*2) (see NOTES next page)	Irregular size paper is loaded in the main body tray.	Load regular size copy paper in the tray.
P12	Irregular size paper is loaded in the option tray.	Load regular size copy paper in the tray.
P20	The drum unit or developing unit is not loaded in the main body.	Open the upper unit and load the drum unit or developing unit in the main body.
P24(*1) (see NOTES next page)	The drum life is nearly over and will need to be replaced after about 500 more copies are made.	Prepare to replace the new drum unit, as copying will stop when the drum life is over.
P24 (blinking)	The drum life is over. Copying will stop immediately after copy paper discharges.	Replace the drum unit and initialize the drum unit newly loaded.
P25	Copying stops while toner is being replenished.	Wait until toner replenishment is completed.
P25 (blinking)	Toner is empty. Copying stops immediately after copy paper discharges. See p. 2-7 ~ p. 2-9.	Replenish the drum unit with toner.

Error Codes and Remedies (continued)

P Code (continued)

Error code	Meaning / Cause	Remedy
P26	The developing unit is not yet initialized.	Initialize developing unit immediately.
P27(*1)	Errors P24& P29 occur at the same time.	Replace the developing/drum unit soon.
P29(*1)	Developer unit life is nearly over.	Replace the developing unit soon.
P29 (blinking)	If toner runs out, code [P29] starts blinking and copying stops.	Replace the developing unit, then initialize the new developing unit.
P51	The upper unit is open.	Close the upper unit securely.

NOTES:

- (1*) appears when Auto Clear function operates or when power is turned on. To clear the signs, press any key on the keypad or press [STOP/CLEAR] or [START PRINT].
- (2*) appears when copying finishes or the Auto Clear function operates or the power is turned on.

Error Codes and Remedies (continued)

F Code

Service Codes (F Codes) indicate machine conditions that require the attention of your Konica service representative.

If an abnormal machine condition exists, an F Code will flash in the Print quantity/Magnification ratio window, and the copier will remain in the WAIT condition until power is turned off. Service Codes are listed below:

Error code	Meaning / Cause	Remedy
F41, F42, F43, F45, F50, F52, F54	Copying cannot be performed.	Turn power switch off, then turn it on. If the code remains, contact your Konica service representative.
F34, F35, F36	Trouble occurs in the fixing unit.	Turn power switch off, unplug copier and contact your Konica service representative.
F26	The developing unit is not initialized correctly.	Initialize the developing unit again.

Chapter 7

Specifications

Specifications	7-2
----------------------	-----

Specifications

Type:	Desk-top with stationary platen
Copying system:	Dry Electrostatic Transfer
Originals:	Books, Sheets, 3-Dimensional objects
Max. original size:	Legal 8.5"x14"/257x364 mm
Max. copy size:	Legal (8.5"x14")
Bypass size:	8.5"x14"~5.5"x8.5"
Max. copy speed:	12 cpm (Letter)
First copy out speed:	7.9 seconds (Letter)
Copy paper weight:	16 lbs~24 lbs Bypass 16 lb~32 lb
Magnification ratio:	1:1 same size (100%) preset (129%,77%) Zoom (70%~141%) 1% increments
Paper capacity:	User-adjustable tray 250 sheets (20 lb) Manual feed bypass - 1sheet
Multiple copying:	Up to 99 copies
Copy exit tray:	Capacity: 250 sheets
Warm-up time:	Approximately 20 sec.
Power consumption:	10A (120V) Stand-By: 10W (Heater On); 16W (Heater Off)
Power source:	AC Local Voltage and Frequency
Dimensions:	23.0" (583) (W) x 21.1" (536) (D) x 13.5" (343) (H)
Weight:	61.7 lb/28 kg
Accessories:	Paper Exit Tray/ User's Manual/ User's Service Guide/ Installation Report/ Power Cord/ Toner Cartridge/ Cleaning Pad/ Developing Unit/ Drum Unit

Specification are subject to change without notice.

A	
Add toner lamp	3-4
Auto clear function	4-7
B	
Basic copying	4-2
C	
Caution labels	1-2, 1-3
Cleaning pad	3-3, 5-4
Control panel	3-4
Copy counter function	4-7, 4-10
D	
Developing unit	2-4, 3-3, 5-10
Drum unit	2-4, 5-6
E	
Error codes	6-4
(enlarge) button	3-6
F	
Fixing unit	3-3
Function codes	4-10
L	
LENS MODE button	3-6
M	
MAGNIFICATION button	3-6
Main body tray	3-2
Main body tray selection lamp	3-4
Manual feed bypass tray	2-15, 3-2
N	
Numeric keypad	3-6
O	
One-to-one (1:1) mode lamp	3-5
Option tray	3-2
Option tray selection lamp	3-4

P

Paper exit tray	2-10, 3-2
Paper monitoring lamp	3-4
Paper trays	2-10, 3-2
Copy density control knob	3-6
Platen cover	3-2
Power	3-2
Power save mode	4-7
Power switch	3-2
Preset magnification indicators	3-4
Preset magnification mode lamp	3-5
Preset mode	4-5
Print quantity/Magnification ratio window	3-5
Protective packing materials	2-2

R

READY indicator	3-5
RE (reduce) button	3-6

S

SELECT PAPER button	3-6
START PRINT button	3-5
STOP/CLEAR button	3-5

T

Toner, adding	2-7
Toner cartridge	3-3

U

Upper unit release button	3-2
---------------------------------	-----

W

Warning	1-4, 1-5
---------------	----------

Z

Zoom mode	4-6
Zoom mode lamp	3-5



Konica Business Technologies, Inc.
500 Day Hill Road Windsor, CT 06095
Telephone (860) 683-2222
OP-01-1312