



PU-DLS
PU-DL

User Guide

Motherboard

E1302

First Edition V1

April 2003

Copyright © 2003 ASUSTeK COMPUTER INC. All Rights Reserved.

No part of this manual, including the products and software described in it, may be reproduced, transmitted, transcribed, stored in a retrieval system, or translated into any language in any form or by any means, except documentation kept by the purchaser for backup purposes, without the express written permission of ASUSTeK COMPUTER INC. ("ASUS").

Product warranty or service will not be extended if: (1) the product is repaired, modified or altered, unless such repair, modification or alteration is authorized in writing by ASUS; or (2) the serial number of the product is defaced or missing.

ASUS PROVIDES THIS MANUAL "AS IS" WITHOUT WARRANTY OF ANY KIND, EITHER EXPRESS OR IMPLIED, INCLUDING BUT NOT LIMITED TO THE IMPLIED WARRANTIES OR CONDITIONS OF MERCHANTABILITY OR FITNESS FOR A PARTICULAR PURPOSE. IN NO EVENT SHALL ASUS, ITS DIRECTORS, OFFICERS, EMPLOYEES OR AGENTS BE LIABLE FOR ANY INDIRECT, SPECIAL, INCIDENTAL, OR CONSEQUENTIAL DAMAGES (INCLUDING DAMAGES FOR LOSS OF PROFITS, LOSS OF BUSINESS, LOSS OF USE OR DATA, INTERRUPTION OF BUSINESS AND THE LIKE), EVEN IF ASUS HAS BEEN ADVISED OF THE POSSIBILITY OF SUCH DAMAGES ARISING FROM ANY DEFECT OR ERROR IN THIS MANUAL OR PRODUCT.

SPECIFICATIONS AND INFORMATION CONTAINED IN THIS MANUAL ARE FURNISHED FOR INFORMATIONAL USE ONLY, AND ARE SUBJECT TO CHANGE AT ANY TIME WITHOUT NOTICE, AND SHOULD NOT BE CONSTRUED AS A COMMITMENT BY ASUS. ASUS ASSUMES NO RESPONSIBILITY OR LIABILITY FOR ANY ERRORS OR INACCURACIES THAT MAY APPEAR IN THIS MANUAL, INCLUDING THE PRODUCTS AND SOFTWARE DESCRIBED IN IT.

Products and corporate names appearing in this manual may or may not be registered trademarks or copyrights of their respective companies, and are used only for identification or explanation and to the owners' benefit, without intent to infringe.

Contents

| | |
|---|------|
| Notices | vi |
| Safety information | vii |
| About this guide | viii |
| ASUS contact information | x |
| PU-DLS/PU-DL specifications summary | xi |

Chapter 1: Product introduction

| | |
|-----------------------------------|-----|
| 1.1 Welcome! | 1-1 |
| 1.2 Package contents | 1-1 |
| 1.3 Special features | 1-2 |
| 1.3.1 Product highlights | 1-2 |
| 1.3.2 Value-added solutions | 1-4 |
| 1.4 Motherboard overview | 1-6 |
| 1.4.1 Major components | 1-6 |
| 1.4.2 Core specifications | 1-8 |

Chapter 2: Hardware information

| | |
|---|------|
| 2.1 Motherboard installation | 2-1 |
| 2.1.1 Placement direction | 2-1 |
| 2.1.2 Screw holes | 2-1 |
| 2.2 Motherboard layout | 2-2 |
| 2.3 Before you proceed | 2-3 |
| 2.4 Central Processing Unit (CPU) | 2-4 |
| 2.4.1 Overview | 2-4 |
| 2.4.2 Installing the CPU | 2-5 |
| 2.4.3 Installing the CPU heatsink and fan | 2-6 |
| 2.5 System memory | 2-8 |
| 2.5.1 Overview | 2-8 |
| 2.5.2 Memory Configurations | 2-9 |
| 2.5.3 Installing a DIMM | 2-10 |
| 2.5.4 Removing a DIMM | 2-10 |
| 2.6 Expansion slots | 2-11 |
| 2.6.1 Installing an expansion card | 2-11 |
| 2.6.2 Configuring an expansion card | 2-11 |
| 2.6.3 PCI slots | 2-13 |

Contents

| | | |
|-----|------------------|------|
| 2.7 | Jumpers | 2-14 |
| 2.8 | Connectors | 2-18 |

Chapter 3: Powering up

| | | |
|-----|--------------------------------------|-----|
| 3.1 | Starting up for the first time | 3-1 |
| 3.2 | Powering off the computer | 3-2 |

Chapter 4: BIOS setup

| | | |
|-------|--|------|
| 4.1 | Managing and updating your BIOS | 4-1 |
| 4.1.1 | Creating a bootable disk | 4-1 |
| 4.1.2 | Updating the BIOS | 4-3 |
| 4.2 | BIOS Setup program | 4-5 |
| 4.2.1 | BIOS menu bar | 4-6 |
| 4.2.2 | Legend bar | 4-6 |
| 4.3 | Main Menu | 4-8 |
| 4.3.1 | Primary and Secondary Master/Slave | 4-10 |
| 4.3.2 | Keyboard Features | 4-14 |
| 4.4 | Advanced Menu | 4-15 |
| 4.4.1 | Chip Configuration | 4-17 |
| 4.4.2 | I/O Device Configuration | 4-19 |
| 4.4.3 | PCI Configuration | 4-20 |
| 4.5 | Power Menu | 4-23 |
| 4.5.1 | Power Up Control | 4-25 |
| 4.5.2 | Hardware Monitor | 4-27 |
| 4.6 | Boot Menu | 4-28 |
| 4.7 | Server Menu | 4-30 |
| 4.8 | Exit Menu | 4-31 |

Chapter 5: Driver installation

| | | |
|-------|---------------------------|-----|
| 5.1 | Support CD contents | 5-1 |
| 5.1.1 | Drivers | 5-1 |
| 5.1.2 | Management Software | 5-1 |

Contents

| | | |
|-------|---|------|
| 5.1.3 | Utilities | 5-2 |
| 5.1.4 | Contact | 5-2 |
| 5.2 | Microsoft® Windows® NT Server 4.0 | 5-3 |
| 5.2.1 | Adaptec® SCSI driver installation | 5-3 |
| 5.2.2 | Intel® 82544GC/82540EM LAN driver installation .. | 5-6 |
| 5.2.3 | ATI® Rage XL display driver installation | 5-11 |
| 5.3 | Microsoft® Windows® 2000 Server | 5-12 |
| 5.3.1 | Adaptec® SCSI driver installation | 5-12 |
| 5.3.2 | Intel® 82544GC/82540EM LAN driver installation | 5-16 |
| 5.3.3 | ATI® Rage XL Display Driver Installation | 5-21 |
| 5.3.4 | Enabling ATA100 Feature in Windows® 2000 | 5-21 |
| 5.4 | Microsoft® Windows® XP Professional | 5-22 |
| 5.4.1 | Adaptec® SCSI driver installation | 5-22 |
| 5.4.2 | Intel® 82544GC/82540EM LAN Driver Installation | 5-25 |
| 5.4.3 | ATI® Rage XL Display Driver Installation | 5-30 |
| 5.5 | Novell® NetWare® Server | 5-31 |
| 5.5.1 | Adaptec® SCSI Driver Installation | 5-31 |
| 5.5.2 | Intel® 82544GC/82540EM LAN driver installation | 5-36 |
| 5.5.3 | ATI® Rage XL Display Driver Installation | 5-38 |
| 5.6 | SCO Open Server 5.0.6 | 5-39 |
| 5.6.1 | Intel® 82544GC/82540EM LAN Driver Installation | 5-39 |
| 5.6.2 | ATI® Rage XL Display Driver Installation | 5-40 |
| 5.7 | Linux RedHat 8.0 | 5-41 |
| 5.7.1 | Adaptec® SCSI Driver Installation | 5-41 |
| 5.7.2 | Inte® 82544GC/82540EM LAN Driver Installation | 5-41 |
| 5.7.3 | ATI® Rage XL Display Driver Installation | 5-42 |

Notices

Federal Communications Commission Statement

This device complies with FCC Rules Part 15. Operation is subject to the following two conditions:

- This device may not cause harmful interference, and
- This device must accept any interference received including interference that may cause undesired operation.

This equipment has been tested and found to comply with the limits for a Class B digital device, pursuant to Part 15 of the FCC Rules. These limits are designed to provide reasonable protection against harmful interference in a residential installation. This equipment generates, uses and can radiate radio frequency energy and, if not installed and used in accordance with manufacturer's instructions, may cause harmful interference to radio communications. However, there is no guarantee that interference will not occur in a particular installation. If this equipment does cause harmful interference to radio or television reception, which can be determined by turning the equipment off and on, the user is encouraged to try to correct the interference by one or more of the following measures:

- Reorient or relocate the receiving antenna.
- Increase the separation between the equipment and receiver.
- Connect the equipment to an outlet on a circuit different from that to which the receiver is connected.
- Consult the dealer or an experienced radio/TV technician for help.



The use of shielded cables for connection of the monitor to the graphics card is required to assure compliance with FCC regulations. Changes or modifications to this unit not expressly approved by the party responsible for compliance could void the user's authority to operate this equipment.

Canadian Department of Communications Statement

This digital apparatus does not exceed the Class B limits for radio noise emissions from digital apparatus set out in the Radio Interference Regulations of the Canadian Department of Communications.

This class B digital apparatus complies with Canadian ICES-003.

Safety information

Electrical safety

- To prevent electrical shock hazard, disconnect the power cable from the electrical outlet before relocating the system.
- When adding or removing devices to or from the system, ensure that the power cables for the devices are unplugged before the signal cables are connected. If possible, disconnect all power cables from the existing system before you add a device.
- Before connecting or removing signal cables from the motherboard, ensure that all power cables are unplugged.
- Seek professional assistance before using an adapter or extension cord. These devices could interrupt the grounding circuit.
- Make sure that your power supply is set to the correct voltage in your area. If you are not sure about the voltage of the electrical outlet you are using, contact your local power company.
- If the power supply is broken, do not try to fix it by yourself. Contact a qualified service technician or your retailer.

Operation safety

- Before installing the product and adding devices on it, carefully read all the documentation that came with the package.
- Before using the product, make sure all cables are correctly connected and the power cables are not damaged. If you detect any damage, contact your dealer immediately.
- To avoid short circuits, keep paper clips, screws, and staples away from connectors, slots, sockets and circuitry.
- Avoid dust, humidity, and temperature extremes. Do not place the product in any area where it may become wet.
- Place the product on a stable surface.
- If you encounter technical problems with the product, contact a qualified service technician or your retailer.

About this guide

This user guide contains the information you need when installing the ASUS PU-DLS/PU-DL motherboard.

How this guide is organized

This manual contains the following parts:

- **Chapter 1: Product introduction**
This chapter describes the features of the PU-DLS/PU-DL motherboard. It includes brief descriptions of the special attributes of the motherboard and the new technology it supports.
- **Chapter 2: Hardware information**
This chapter lists the hardware setup procedures that you have to perform when installing system components. It includes description of the switches, jumpers, and connectors on the motherboard.
- **Chapter 3: Powering up**
This chapter describes the power up sequence and gives information on the BIOS beep codes.
- **Chapter 4: BIOS setup**
This chapter tells how to change system settings through the BIOS Setup menus. Detailed descriptions of the BIOS parameters are also provided.
- **Chapter 5: Driver Installation**
This chapter tells how to install SCSI (for PU-DLS model only), LAN, and audio drivers for various operating systems.

Conventions used in this guide

To make sure that you perform certain tasks properly, take note of the following symbols used throughout this manual.



WARNING: Information to prevent injury to yourself when trying to complete a task.



CAUTION: Information to prevent damage to the components when trying to complete a task.



IMPORTANT: Information that you **MUST** follow to complete a task.



NOTE: Tips and additional information to aid in completing a task.

Where to find more information

Refer to the following sources for additional information and for product and software updates.

1. ASUS Websites

The ASUS websites worldwide provide updated information on ASUS hardware and software products. The ASUS websites are listed in the ASUS Contact Information on page x.

2. Optional Documentation

Your product package may include optional documentation, such as warranty flyers, that may have been added by your dealer. These documents are not part of the standard package.

ASUS contact information

ASUSTeK COMPUTER INC. (Asia-Pacific)

Address: 150 Li-Te Road, Peitou, Taipei, Taiwan 112
General Tel: +886-2-2894-3447
General Fax: +886-2-2894-3449
General Email: info@asus.com.tw

Technical Support

MB/Others (Tel): +886-2-2890-7121 (English)
Notebook (Tel): +886-2-2890-7122 (English)
Desktop/Server (Tel): +886-2-2890-7123 (English)
Support Fax: +886-2-2890-7698
Web Site: www.asus.com.tw

ASUS COMPUTER INTERNATIONAL (America)

Address: 44370 Nobel Drive, Fremont, CA 94538, USA
General Fax: +1-510-608-4555
General Email: tmd1@asus.com

Technical Support

Support Fax: +1-510-608-4555
General Support: +1-510-739-3777
Web Site: www.asus.com
Support Email: tsd@asus.com

ASUS COMPUTER GmbH (Germany and Austria)

Address: Harkortstr. 25, 40880 Ratingen, BRD, Germany
General Email: sales@asuscom.de (for marketing requests only)
General Fax: +49-2102-9599-31

Technical Support

Support Hotlines: Components: +49-2102-9599-0
Notebook PC: +49-2102-9599-10
Support (Email): www.asuscom.de/kontakt (for online support)
Web Site: www.asuscom.de
Support Fax: +49-2102-9599-11

PU-DLS/PU-DL specifications summary



The Onboard SCSI controller, internal SCSI connectors, and SCSI LED connector are available only on PU-DLS models.

| | |
|-----------------------------|--|
| CPU | Support for dual Intel® Xeon™ processors with speeds up to 3.06 GHz On-die 512KB L2 cache |
| Chipsets | Intel E7501 (Plumas 533) MCH Intel ICH3-S I/O Hub P64H2 PCI-X Hub |
| Front Side Bus (FSB) | 533/400 MHz |
| Memory | 6 x 184-pin DDR DIMM sockets Supports PC2100/PC1600 registered ECC DDR DIMMs Supports up to 12GB system memory using 2GB DIMMs |
| Onboard LAN | Intel® 82540EM 32-bit PCI Gigabit Ethernet controller Intel® 82544GC 64-bit PCI-X Gigabit Ethernet controller |
| Onboard SCSI | Adaptec® AIC-7902W Ultra-320 SCSI controller |
| Expansion slots | 4 x PCI 64-bit/100MHz 3V (PCI-X1 to PCI-X4) 2 x PCI 32-bit/33MHz 5V (PCI1, PCI2) |
| Rear panel I/O | 1 x Parallel port 2 x Serial ports 1 x VGA port 1 x PS/2 keyboard port 1 x PS/2 mouse port 2 x USB 1.1 ports 2 x RJ-45 ports (with LED) |
| Internal connectors | 2 x ATA/100 IDE connectors 1 x Floppy disk connector 2 x 68-pin Ultra 320 SCSI connectors eRMC and IPMI connectors (for ASMC) CPU/Chassis fan connectors 24-pin/8-pin SSI power connectors IDE LED/SCSI LED connectors 20-pin Front panel connector Chassis intrusion, SMBus, and WOR connectors |

(Continued next page)

* Specifications are subject to change without notice.

PU-DLS/PU-DL specifications summary

| | |
|----------------------------|---|
| BIOS features | 4Mb Firmware Hub (FWH), Award BIOS with ACPI, DMI, Green, PnP features, and Enhanced Server BIOS features |
| Form Factor | Extended ATX form factor: 12 in x 13 in (30.5 cm x 33 cm) |
| Support CD contents | Device drivers Management software Utilities Contact information |

Chapter 1

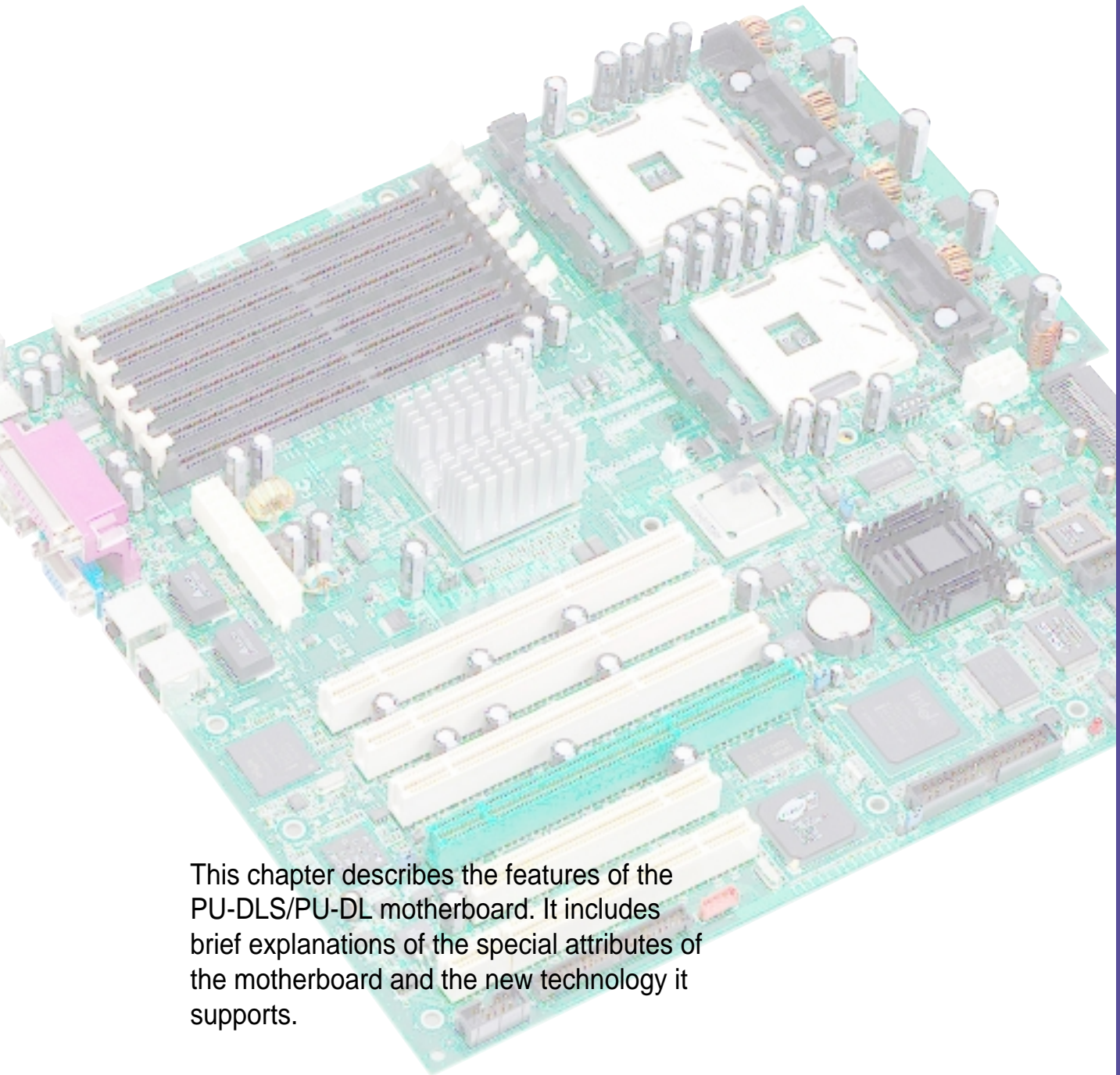

This chapter describes the features of the PU-DLS/PU-DL motherboard. It includes brief explanations of the special attributes of the motherboard and the new technology it supports.

Product introduction

Chapter summary

| | | |
|------------|-----------------------------------|------------|
| 1.1 | Welcome! | 1-1 |
| 1.2 | Package contents | 1-1 |
| 1.3 | Special features | 1-2 |
| 1.4 | Motherboard overview | 1-6 |

1.1 Welcome!

Thank you for buying the ASUS® PU-DLS/PU-DL motherboard!

The ASUS PU-DLS/PU-DL motherboard delivers a host of new features and latest technologies making it another standout in the long line of ASUS quality server motherboards!

The PU-DLS/PU-DL incorporates dual Intel® Xeon™ processors in 604-pin package coupled with the Intel® E7501 (Plumas 533) chipset to deliver a reliable and high performance dual-processor server platform.

Before you start installing the motherboard, and hardware devices on it, check the items in your package with the list below.

1.2 Package contents

Check your PU-DLS/PU-DL package for the following items.

- ✓ ASUS PU-DLS/PU-DL motherboard
Extended ATX form factor: 12 in x 13 in (30.5 cm x 33 cm)
- ✓ ASUS PU-DLS/PU-DL support CD
- ✓ I/O shield
- ✓ 80-conductor ribbon cable for UltraDMA100/66/33 IDE drives
- ✓ Ribbon cable for a 3.5-inch floppy drive
- ✓ Bag of extra jumper caps
- ✓ PU-DLS/PU-DL User Guide



If any of the above items is damaged or missing, contact your retailer.

1.3 Special features

1.3.1 Product highlights

Latest processor technology

The PU-DLS/PU-DL motherboard supports the Intel® Xeon processor via dual 604-pin surface mount ZIF sockets. The processor features the Intel® NetBurst™ micro-architecture that includes hyper-threading technology, a rapid execution engine, a 533/400MHz system bus, and an execution trace cache to offer a significant increase in performance. See page 2-4 for more information.

DDR memory support

Employing the Double Data Rate (DDR) memory technology, the PU-DLS motherboard supports up to 12GB of system memory using PC2100/1600 registered ECC DDR DIMMs. The ultra-fast 266/200MHz memory bus doubles the speed of the PC133/PC100 SDRAM to deliver the required bandwidth for the latest 3D graphics, multimedia, and Internet applications.

Advanced 64-bit PCI-X bus

The 64-bit/133MHz PCI-X bus onboard maximizes I/O bandwidth for the next generation 64-bit PCI-X cards that support 133MHz bus. The PCI-X specification 1.0a allows full peer-to-peer transactions between PCI buses and provides options for intelligent I/O and server management cards.

Onboard LAN

The motherboard comes with the Intel® 82540EM 32-bit PCI Gigabit Ethernet controller, and the Intel® 82544GC 64-bit PCI-X Gigabit Ethernet controller, to fully support 10/100/1000BASE-T Gigabit Ethernet Media Access Control (IEEE 802.3 compliant), and provide Physical Layer Transceiver solution for high performance network applications.

Dual-channel Ultra-320 SCSI

The Adaptec 7902W Ultra-320 SCSI controller and dual-channel SCSI connectors are onboard to provide high-speed data transfers.



The Dual-Channel Ultra-320 SCSI features are available only on PU-DLS models.

Zero-Channel RAID (ZCR) feature

One 64-bit PCI-X slot on the motherboard supports the Zero-Channel RAID feature and multi-level RAID 0, 1, 5.



The Zero-Channel RAID Card for ZCR function is supported only on PU-DLS models.

ATA/100 IDE support

The dual-channel bus master IDE connectors comply with the ATA/100 protocol and supports ATA/100, Multi-Word DMA Mode2, PIO modes 3 & 4 IDE devices such as ATAPI IDE CD-ROM, CD-R/RW, ZIP, and LS-120 drives.

1.3.2 Value-added solutions

Temperature, fan, and voltage monitoring

The CPU temperature is monitored by the ASUS ASIC to prevent overheating and damage. The system fan rotations per minute (RPM) is monitored for timely failure detection. The system voltage levels are monitored to ensure stable supply of current for critical components.

Dual function power switch

While the system is ON, pressing the power switch for less than 4 seconds puts the system to sleep mode or to soft-off mode, depending on the BIOS setting. Pressing the power switch for more than 4 seconds lets the system enter the soft-off mode regardless of the BIOS setting.

Wake-Up support

The motherboard includes Wake-On-LAN, Wake-On-Ring, and BIOS Wake-Up features.

ACPI ready

The Advanced Configuration power Interface (ACPI) provides more energy saving features for operating systems that support OS Direct Power Management (OSPM).

Concurrent PCI

This feature allows multiple PCI transfers from PCI master buses to the memory and processor.

Chassis intrusion detection

With this feature, the chassis intrusion circuitry logs “chassis-open” events into the system BIOS. The onboard battery supports the chassis intrusion detection feature even when the normal power is removed.

Smart BIOS

The 4Mbit firmware hub (FWH) gives an easy-to-use interface that provides more control and protection to the motherboard. The BIOS has a boot block write protection and HD/SCSI/MO/ZIP/CD/Floppy boot selection.



The SCSI boot selection is available only on PU-DLS BIOS setup.

Compliance

Both the BIOS and the hardware levels of the motherboard meet the stringent requirements for SDG 2.0 certification. The new SDG 2.0 requirements for systems and components are based on the following high-level goals: support for Plug-and-Play compatibility and power management for configuring and managing all system components, 32-bit device drivers, and installation procedures for Windows NT/2000/XP. Color-coded connectors and descriptive icons make identification easy as required by the PC '99 specification.

1.4 Motherboard overview

Before you install the PU-DLS/PU-DL motherboard, familiarize yourself with its physical configuration and available features to facilitate the motherboard installation and future upgrades. A sufficient knowledge of the motherboard specifications will also help you avoid mistakes that may damage the board and its components.

1.4.1 Major components

The following are the major components of the PU-DLS/PU-DL motherboard as pointed out in the picture on page 1-7.

1. SSI-type power connector
2. DDR DIMM sockets
3. Intel® E7501 northbridge
4. Intel® P64H2 PCI-X Hub
5. 604-pin CPU sockets
6. 8-pin 12V SSI power connector
7. SCSI connector (optional)
8. Adaptec 7902W SCSI controller
9. Firmware hub (FWH)
10. IDE connectors
11. Standby power LED
12. SCSI connector
13. ASUS ASIC
14. CPU Power Fail LED
15. LPC Super I/O controller
16. Floppy connector
17. Intel® ICH3-S I/O Hub
18. ATI Rage-XL VGA controller
19. PCI-X slots (PCI-X1 to PCI-X4)
PCI slots (PCI1, PCI2)
20. Intel® 82540EM 32-bit PCI
Gigabit Ethernet controller
21. Intel® 82544GC 64-bit PCI-X
Gigabit Ethernet controller
22. PS/2 mouse port
23. Parallel port
24. RJ-45 port (for 32-bit LAN)
25. RJ-45 port (for 64-bit LAN)
26. VGA port
27. Serial port (COM1)
28. USB 1.1 ports 1 and 2
29. Keyboard port



The Adaptec 7902W SCSI controller and the onboard SCSI connectors are available only on PU-DLS models.

See page 1-8 for the specifications of each component. Refer to Chapter 2 for detailed information on the components.

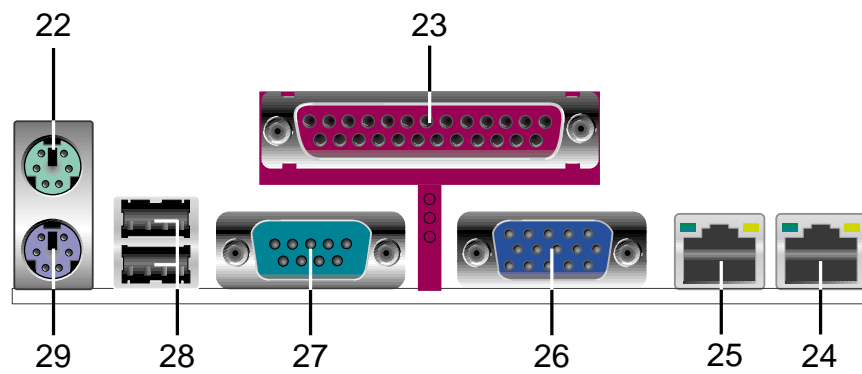
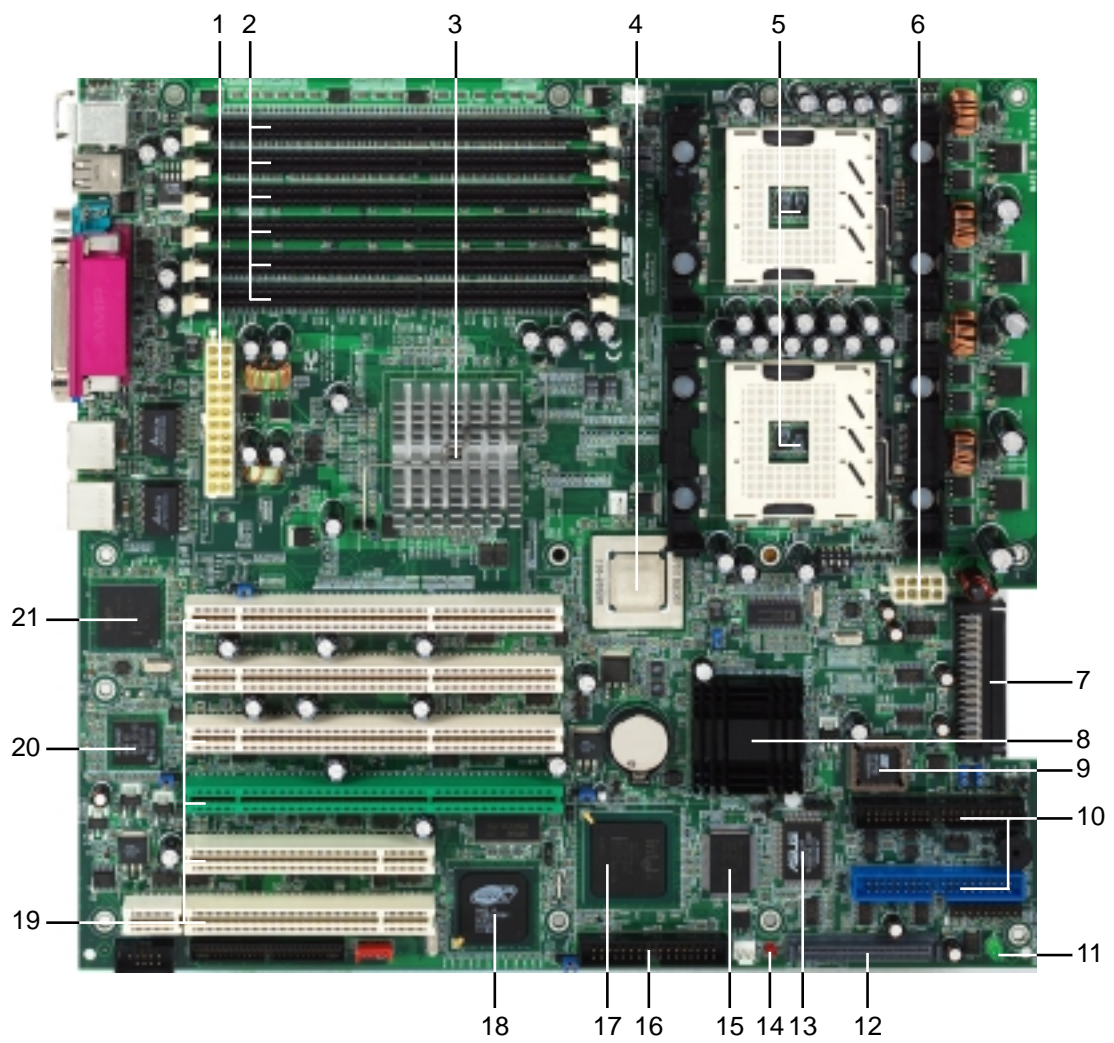

1.4.2 Core specifications

- 1 SSI/ATX power connector.** This 24/20-pin connector is for an SSI-type/ATX power supply.
- 2 DDR DIMM sockets.** These six 184-pin DIMM sockets support up to 12GB system memory using registered ECC PC2100/1600 DDR DIMMs.
- 3 Intel® E7501 (Plumas 533) MCH.** The E7501 Memory Controller Hub (MCH) processor interface supports the System Bus Protocol at peak bandwidth of 3.2 GB/s (400 MHz) or 4.26 GB/s (533 MHz), and is optimized for dual Intel Xeon processors with 512-KB L2 cache. The MCH supports a 144-bit wide channel of Double Data Rate (DDR) DRAM operating in lock-step, and provides Hub Interface 1.5 connection for ICH3-S and Hub Interface 2.0 connection for P64H2 devices.
- 4 Intel® P64H2 PCI-X hub.** The P64H2 is PCI/PCI-X 64-bit Hub 2 that provides high-performance I/O capability including 16-bit Hub Interface 2.0 connection to MCH, and two independent 64-bit PCI/PCI-X interfaces.
- 5 604-pin CPU sockets.** Two 604-pin surface mount, Zero Insertion Force (ZIF) sockets are onboard for the Intel® Xeon™ processor with 512KB L2 cache and a 400/533 MHz system bus that allows up to 3.2GB/s or 4.26GB/s data transfer rate. These sockets also support Intel Xeon CPUs with Hyper-Threading Technology feature.
- 6 8/4-pin 12V SSI power connector.** This 8/4-pin connector is for an SSI-type/ATX power supply.
- 7 SCSI connector.** This dual-channel SCSI connector supports up to 30 devices and data transfers of 320Mbps.



The onboard SCSI connectors are available only on PU-DLS models.

- 8 Adaptec® AIC-7902W SCSI controller.** The 7902W SCSI controller is a PCI-X dual-channel Ultra320 SCSI ASIC compliant to PC 2000-2001. Each channel supports a data transfer rate up to 320 MB/s on a Wide (16-bit) SCSI bus with Low Voltage Differential (LVD) devices. The combined available SCSI throughput is 640 MB/s. In PCI and PCI-X modes, the controller operates as a multifunction 32-bit or 64-bit bus master.



The Adaptec® AIC-7902W SCSI controller is available only on PU-DLS models.

- 9** **Firmware hub.** This 4Mb firmware hub (FWH) contains the programmable BIOS program.
- 10** **IDE connectors.** These dual-channel bus master IDE connectors support up to four Ultra DMA/100/66, PIO Modes 3 & 4 IDE devices. Both the primary (blue) and secondary (black) connectors are slotted to prevent incorrect insertion of the IDE ribbon cable.
- 11** **Standby power LED.** This LED lights up if there is a standby power on the motherboard, and serves as a reminder to turn off the system power before plugging or unplugging devices.
- 12** **SCSI connector.** (See description of item 7.)
- 13** **ASUS ASIC.** This chip performs multiple system functions that include hardware and system voltage monitoring, IRQ routing, among others.
- 14** **CPU power fail LED.** When lit, this LED (CPULED1) indicates that the CPUs installed on the motherboard are not identical. This LED does not light up if there is only one CPU.
- 15** **LPC super I/O controller.** This Low Pin Count (LPC) interface provides the commonly used Super I/O functionality. The chipset supports UART compatible serial ports, one parallel port with EPP and ECP capabilities, a floppy drive, and PS/2 keyboard and mouse.
- 16** **Floppy disk connector.** This connector accommodates the provided ribbon cable for the floppy disk drive. One side of the connector is slotted to prevent incorrect insertion of the floppy disk cable.
- 17** **Intel® ICH3-S I/O hub.** The I/O Controller Hub 3 (ICH3-S) provides the legacy I/O subsystem and integrates various I/O functions. The ICH3-S provides Hub Interface 1.5 connection to the MCH, dual-channel Ultra ATA/100 bus master IDE controller, integrated LAN controllers, three Universal Host Controller Interface (UHCI) USB 1.1 compliant host controllers, I/O APIC, SMBus Specification Rev. 2.0 compliance, Low-Pin Count (LPC) interface, PCI Local Bus Specification Rev. 2.2 compliance.
- 18** **ATI Rage-XL VGA controller.** This PCI-based VGA controller supports 8MB display SDRAM for 1280x1024 and true color resolutions.

- 19** **PCI-X/PCI slots.** Four 64-bit/100MHz PCI-X slots and two 32-bit/33MHz PCI expansion slots support bus master PCI-X/PCI cards.
- 20** **Intel® 82540EM 32-bit PCI Gigabit Ethernet controller.** This LAN controller provides a 32-bit interface and supports 10/100/1000 Mbps data transfer rates.
- 21** **Intel® 82545GC 64-bit PCI-X Gigabit Ethernet controller.** This LAN controller is integrated Ethernet LAN component that supports 10/100/1000Mbps data rates. The 82544GC is optimized for LAN on Motherboard (LOM), enterprise networking, and Internet appliances that use a PCI or PCI-X bus. The controller provides a 32/64-bit 33/66MHz interface to the PCI bus that supports PCI Specification Rev. 2.2, and to the PCI-X extension to the PCI Local Bus Rev. 1.0a at clock rates of up to 133MHz.
- 22** **PS/2 mouse port.** This green 6-pin connector is for a PS/2 mouse.
- 23** **Parallel port.** This 25-pin port connects a parallel printer, a scanner, or other devices.
- 24** **RJ-45 port (for 32-bit LAN).** This port allows connection to a Local Area Network (LAN) through a network hub. This port is supported by the 32-bit Intel® 82540EM LAN controller.
- 25** **RJ-45 port (for 64-bit LAN).** This port allows connection to a Local Area Network (LAN) through a network hub. This port is supported by the 64-bit Intel® 82544GC LAN controller.
- 26** **Video port.** This port is for a VGA monitor or other VGA-compatible devices.
- 27** **Serial port.** This 9-pin COM1 port is for pointing devices or other serial devices. A COM2 interface is also available. See section “2.8 Connectors.”
- 28** **USB 1.1 ports 1 and 2.** These 4-pin Universal Serial Bus (USB) ports are available for connecting USB devices.
- 29** **PS/2 keyboard port.** This purple 6-pin connector is for a PS/2 keyboard.

Chapter 2

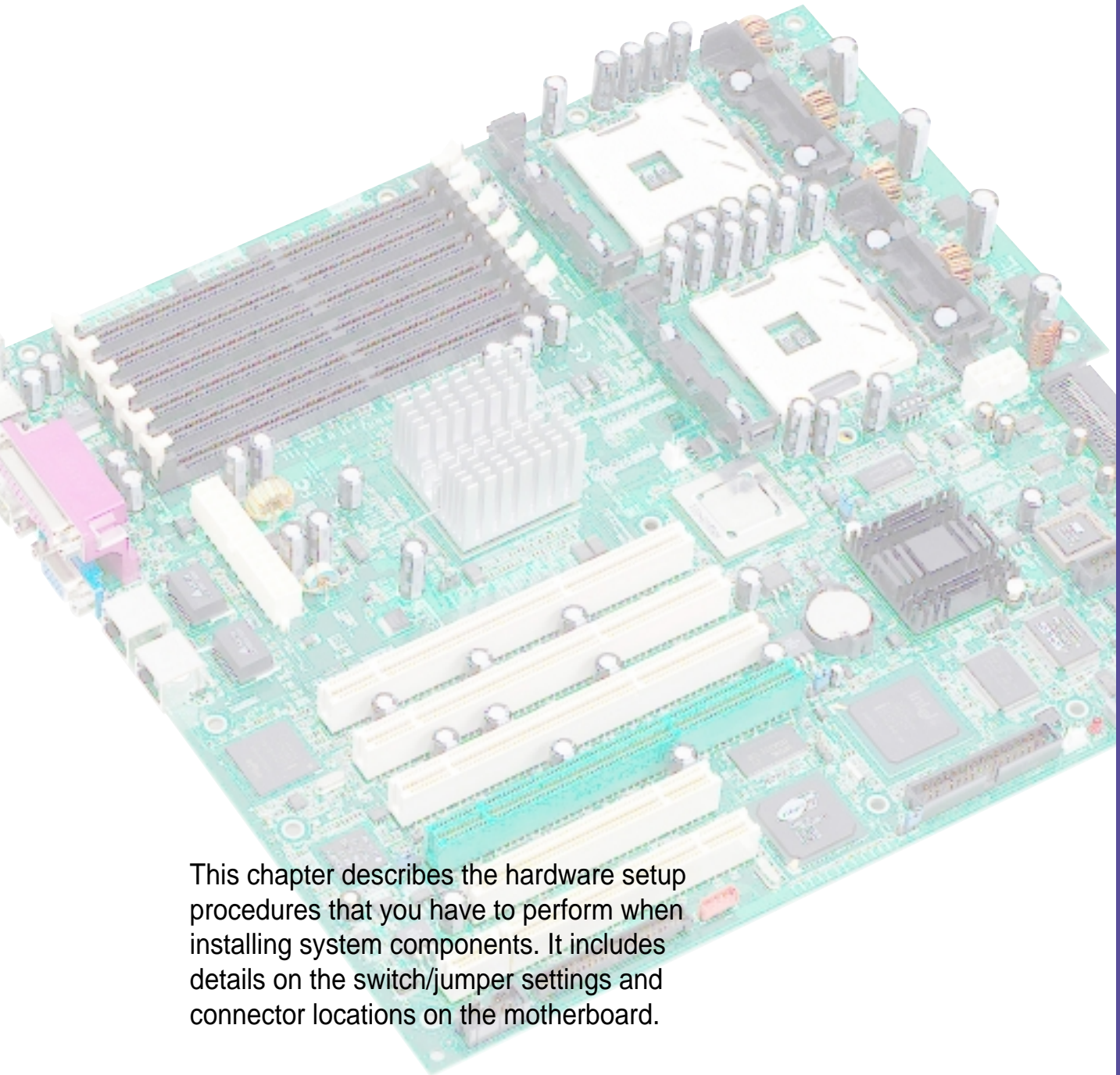

This chapter describes the hardware setup procedures that you have to perform when installing system components. It includes details on the switch/jumper settings and connector locations on the motherboard.

Hardware information

Chapter summary

| | | |
|------------|--|-------------|
| 2.1 | Motherboard installation | 2-1 |
| 2.2 | Motherboard layout | 2-2 |
| 2.3 | Before you proceed | 2-3 |
| 2.4 | Central Processing Unit (CPU) | 2-4 |
| 2.5 | System memory | 2-8 |
| 2.6 | Expansion slots | 2-11 |
| 2.7 | Jumpers | 2-14 |
| 2.8 | Connectors | 2-18 |

2.1 Motherboard installation

Before you install the motherboard, study the configuration of your chassis to ensure that the motherboard fits into it. The PU-DLS/PU-DL uses the extended ATX form factor that measures 12 in x 13 in (30.5 cm x 33 cm).



Make sure to unplug the power cord before installing or removing the motherboard. Failure to do so may cause you physical injury and damage motherboard components.

2.1.1 Placement direction

When installing the motherboard, make sure that you place it into the chassis in the correct orientation. The edge with external ports goes to the rear part of the chassis as indicated in the image below.

2.1.2 Screw holes

Place 10 screws into the holes indicated by circles to secure the motherboard to the chassis.



Do not overtighten the screws! Doing so may damage the motherboard.

Place this side towards the rear of the chassis.

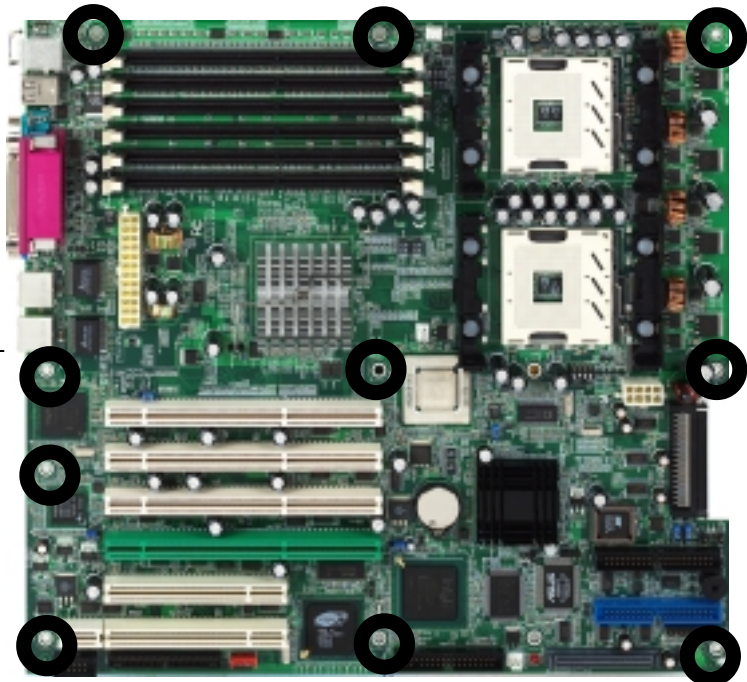

2.3 Before you proceed

Take note of the following precautions before you install motherboard components or change any motherboard settings.



1. Unplug the power cord from the wall socket before touching any component.
2. Use a grounded wrist strap or touch a safely grounded object or to a metal object, such as the power supply case, before handling components to avoid damaging them due to static electricity.
3. Hold components by the edges to avoid touching the ICs on them.
4. Whenever you uninstall any component, place it on a grounded antistatic pad or in the bag that came with the component.
5. **Before you install or remove any component, ensure that the ATX power supply is switched off or the power cord is detached from the power supply.** Failure to do so may cause severe damage to the motherboard, peripherals, and/or components.



When lit, the CPU power fail LED (CPULED1) indicates that the CPUs installed are not identical. Make sure to install identical CPUs if you wish to use the dual-processor capability. This LED does not light up if you installed only one CPU.

When lit, the standby power LED (LED1) indicates that the system is ON, in sleep mode, or in soft-off mode, a reminder that you should shut down the system and unplug the power cable before removing or plugging in any motherboard component.

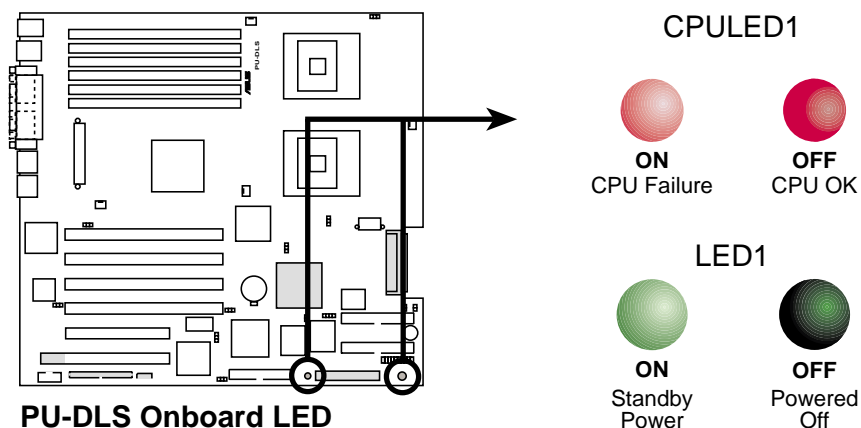

2.4 Central Processing Unit (CPU)

2.4.1 Overview

The motherboard comes with dual surface mount 604-pin Zero Insertion Force (ZIF) sockets. The sockets are designed for the Intel Processor in the 604-pin package with 512KB L2 cache. The processor includes the Intel® NetBurst™ micro-architecture that features the hyper-pipelined technology, rapid execution engine, 533/400MHz system bus, and execution trace cache. Together, these attributes improve system performance by allowing higher core frequencies, faster execution of integer instructions, and data transfer rate of up to 4.2/3.2GB/s.

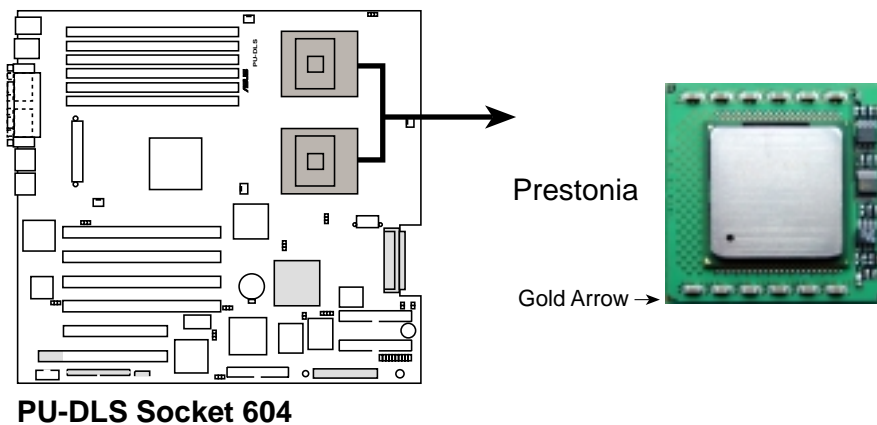

Note in the illustration that the CPU has a gold triangular mark on one corner. This mark indicates the processor Pin 1 that should match a specific corner of the CPU socket.



Incorrect installation of the CPU into the socket may bend the pins and severely damage the CPU!



The motherboard supports either one or two CPUs. If you are installing only one CPU, you **MUST** install the CPU in socket 1.

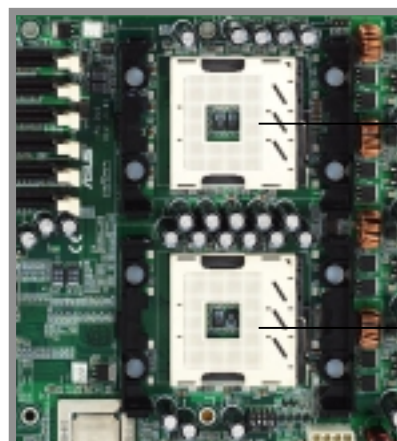

CPU Socket 1
(outer socket)

CPU Socket 2
(inner socket)

2.4.2 Installing the CPU



If you are installing only one CPU, install the CPU in socket 1.

Follow these steps to install a CPU.

1. Locate the 604-pin ZIF sockets on the motherboard. Unlock the socket by pressing the lever sideways, then lift it up to at least 115° angle.



Make sure that the socket lever is lifted up to at least 115° angle, otherwise the CPU does not fit in completely.

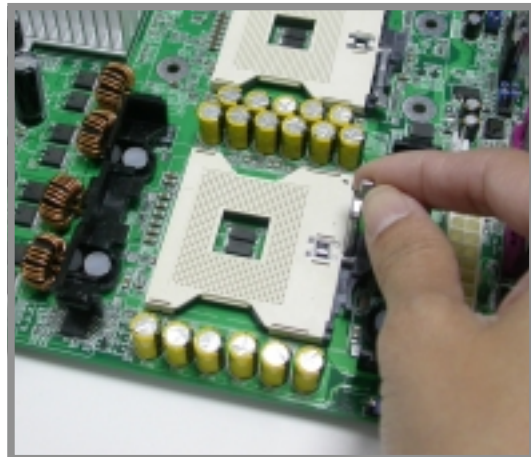

2. Position the CPU above the socket as shown.
3. Carefully insert the CPU into the socket until it fits in place.



The CPU fits only in one correct orientation. **DO NOT** force the CPU into the socket to prevent bending the pins and damaging the CPU!

Marked Corner

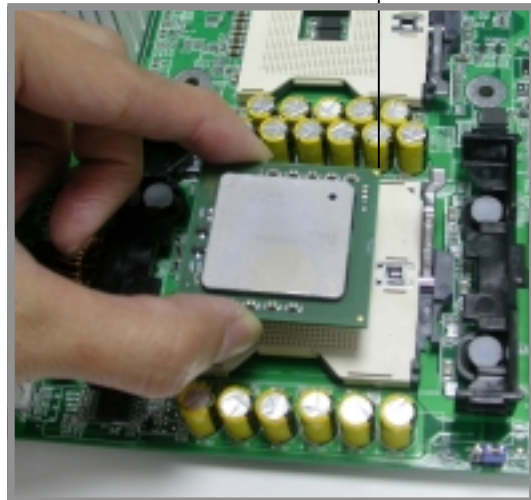

4. When the CPU is in place, push down the socket lever to secure the CPU. The lever clicks on the side tab to indicate that it is locked.



2.4.3 Installing the CPU heatsink and fan

The Intel® Xeon™ processors require specially designed heatsink and fan assembly to ensure optimum thermal condition and performance.

Follow these steps to install the CPU heatsink and fan.

1. Place the heatsink and fan assembly on top of the installed CPU, making sure that it fits in place.



2. Hook one end of the retention bracket into the protruding tab on the corner of the plastic retention base. (The retention base comes installed with the motherboard.)



3. Use a small flat screw driver to attach the other end of the bracket, while firmly holding down the heatsink and fan assembly. The middle hook of the bracket snaps in place if you properly attached the two ends.

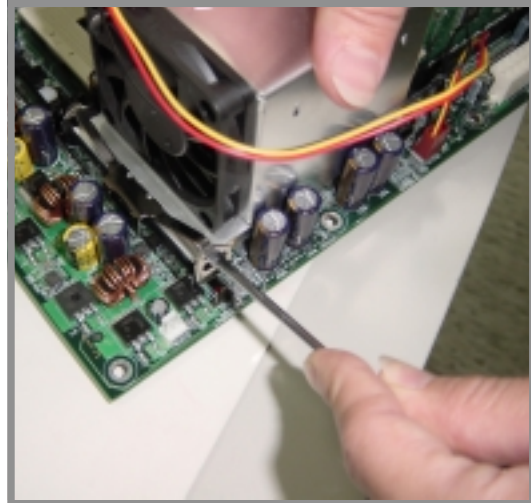

4. As shown, the middle hook of the bracket snaps in place if you properly attached the two ends.
5. Do steps 2 to 4 to install the other bracket.



6. When the heatsink and fan assembly is in place, connect the fan cable to the fan connector on the motherboard labeled CPUFAN1 (for the CPU on socket 1) and CPUFAN2 (for the CPU on socket 2).



Don't forget to connect the CPU fan cable. Hardware monitoring problems may occur if you fail to plug the cable.



2.5 System memory

2.5.1 Overview

The motherboard comes with six Double Data Rate (DDR) Dual Inline Memory Module (DIMM) sockets. These sockets support up to 12GB system memory using 184-pin registered PC2100/1600 DIMMs with Serial Presence Detect (SPD) and Error Check and Correction (ECC).

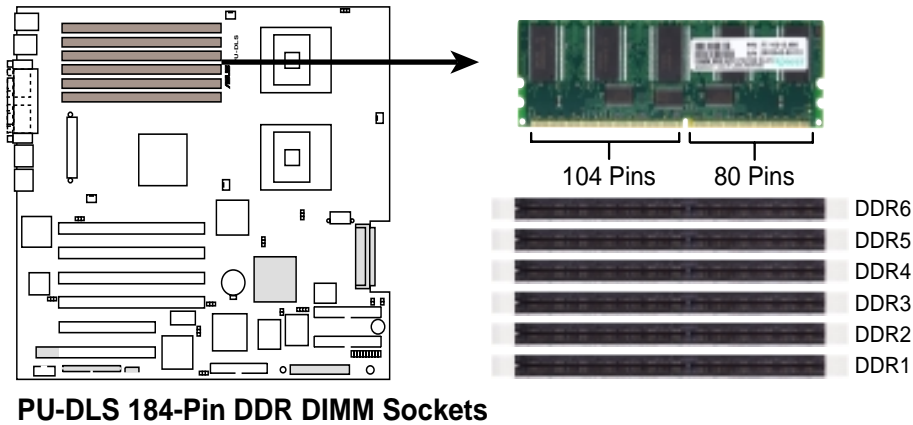

A DDR DIMM is keyed with a notch so that it fits in only one direction. **DO NOT** force a DIMM into a socket to avoid damaging the DIMM.

The DDR SDRAM technology evolved from the mainstream PC66, PC100, PC133 memory known as Single Data Rate (SDR) SDRAM. DDR memory however, has the ability to perform two data operations in one clock cycle, thus providing twice the throughput of SDR memory. For example, a 200MHz DDR DIMM will support a 100MHz memory bus, and a 266MHz DDR DIMM will support a 133MHz memory bus.

| DDR Data Transfer Rate | | DDR Base Frequency |
|------------------------|---|--------------------|
| 266MHz | ➔ | 133MHz |
| 200MHz | ➔ | 100MHz |

A DDR DIMM has the same physical dimensions as an SDR DIMM, but it has a 184-pin footprint compared to the 168-pin of the SDR DIMM. Also, a DDR DIMM is single notched while an SDR DIMM is double notched. Therefore, a DDR DIMM is not backward compatible with SDR, and should be installed only in a socket specially designed for DDR DIMMs.

2.5.2 Memory Configurations

The motherboard supports system memory of up to 12GB in a two-way interleaved/non-interleaved configuration. The interleaved memory configuration requires that you install identical DDR DIMMs (exactly the same type and size) in pairs. The non-interleaved configuration allows you to install DIMMs in DDR1, DDR3, or DDR5 (see DIMM placement table).

The following table lists the DIMM socket pairs and the memory modules that you can install.



The system chipset only supports PC2100/1600 registered ECC DIMMs. Make sure to use only the specified DIMM types for stable system operation.

Memory configuration table

| DIMM Socket | 184-pin ECC DDR DIMM | Total Memory |
|--|---|--------------|
| DDR1 | DDR SDRAM 128MB, 256MB, 512MB, 1GB, 2GB | = |
| DDR2 | DDR SDRAM 128MB, 256MB, 512MB, 1GB, 2GB | = |
| DDR3 | DDR SDRAM 128MB, 256MB, 512MB, 1GB, 2GB | = |
| DDR4 | DDR SDRAM 128MB, 256MB, 512MB, 1GB, 2GB | = |
| DDR5 | DDR SDRAM 128MB, 256MB, 512MB, 1GB, 2GB | = |
| DDR6 | DDR SDRAM 128MB, 256MB, 512MB, 1GB, 2GB | = |
| Total System Memory (Max. 12GB) | | |

Refer to the following table for the correct DDR DIMM placement.

DIMM placement

| | DDR1 | DDR2 | DDR3 | DDR4 | DDR5 | DDR6 |
|--------------|-----------|-----------|-----------|-----------|-----------|-----------|
| One-DIMM * | — | — | — | — | Installed | — |
| Two-DIMM ** | — | — | — | — | Installed | Installed |
| Two-DIMM * | — | — | Installed | — | Installed | — |
| Three-DIMM * | Installed | — | Installed | — | Installed | — |
| Four-DIMM ** | — | — | Installed | Installed | Installed | Installed |
| Six-DIMM ** | Installed | Installed | Installed | Installed | Installed | Installed |

* Memory width is 64-bit; low performance

** Memory width is 128-bit; high performance



If you use a 128-bit memory width configuration, make sure to install identical (the same type and size) DDR DIMM pairs.

2.5.3 Installing a DIMM



Make sure to unplug the power supply before adding or removing DIMMs or other system components. Failure to do so may cause severe damage to both the motherboard and the components.

Follow these steps to install a DIMM.

1. Unlock a DIMM socket by pressing the retaining clips outward.
2. Align a DIMM on the socket such that the notch on the DIMM matches the break on the socket.

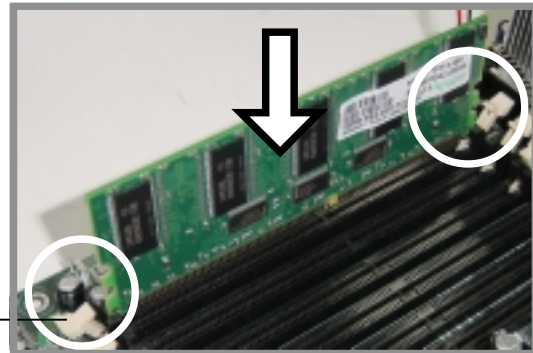

Unlocked Retaining Clip

3. Firmly insert the DIMM into the socket until the retaining clips snap back in place and the DIMM is properly seated.

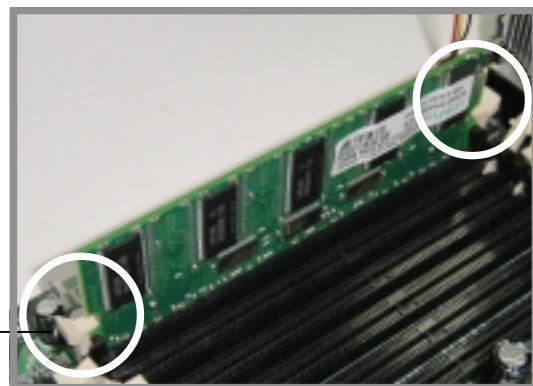

Locked Retaining Clip

2.5.4 Removing a DIMM

Follow these steps to remove a DIMM.

1. Simultaneously press the retaining clips outward to unlock the DIMM.
2. Remove the DIMM from the socket.



Support the DIMM lightly with your fingers when pressing the retaining clips. The DIMM might get damaged when it flips out with extra force.

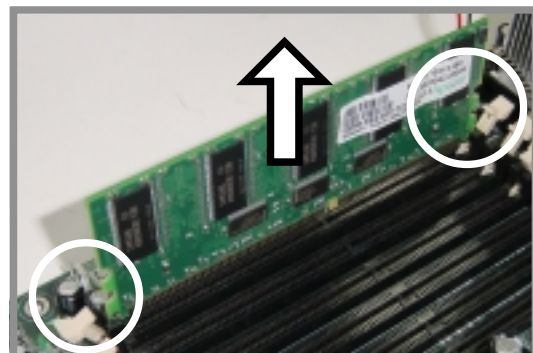

2.6 Expansion slots

In the future, you may need to install expansion cards. The following sub-sections describe the slots and the expansion cards that they support.



Make sure to unplug the power cord before adding or removing expansion cards. Failure to do so may cause you physical injury and damage motherboard components.

2.6.1 Installing an expansion card

Follow these steps to install an expansion card.

1. Before installing the expansion card, read the documentation that came with it and make the necessary hardware settings for the card.
2. Remove the system unit cover (if your motherboard is already installed in a chassis).
3. Remove the bracket opposite the slot that you intend to use. Keep the screw for later use.
4. Align the card connector with the slot and press firmly until the card is completely seated on the slot.
5. Secure the card to the chassis with the screw you removed earlier.
6. Replace the system cover.

2.6.2 Configuring an expansion card

After installing the expansion card, configure the it by adjusting the software settings.

1. Turn on the system and change the necessary BIOS settings, if any. See Chapter 4 for information on BIOS setup.
2. Assign an IRQ to the card. Refer to the tables on the next page.
3. Install the software drivers for the expansion card.

Standard Interrupt Assignments

| IRQ | Priority | Standard Function |
|-----|----------|-----------------------------|
| 0 | 1 | System Timer |
| 1 | 2 | Keyboard Controller |
| 2 | N/A | Programmable Interrupt |
| 3* | 11 | Communications Port (COM2) |
| 4* | 12 | Communications Port (COM1) |
| 5* | 13 | Sound Card (sometimes LPT2) |
| 6 | 14 | Floppy Disk Controller |
| 7* | 15 | Printer Port (LPT1) |
| 8 | 3 | System CMOS/Real Time Clock |
| 9* | 4 | ACPI Mode when used |
| 10* | 5 | IRQ Holder for PCI Steering |
| 11* | 6 | IRQ Holder for PCI Steering |
| 12* | 7 | PS/2 Compatible Mouse Port |
| 13 | 8 | Numeric Data Processor |
| 14* | 9 | Primary IDE Channel |
| 15* | 10 | Secondary IDE Channel |

* These IRQs are usually available for ISA or PCI devices.

IRQ assignments for this motherboard

| | PCI INTA | PCI INTB | PCI INTC | PCI INTD |
|----------------------------|----------|----------|----------|----------|
| PCIX1 slot (supports ZCR) | PIRQB4 | PIRQB5 | PIRQB9 | PIRQB8 |
| PCIX2 slot | PIRQB0 | PIRQB1 | PIRQB2 | PIRQB3 |
| PCIX3 slot | PIRQA4 | PIRQA5 | PIRQA6 | PIRQA7 |
| PCIX4 slot (riser slot A) | PIRQA0 | PIRQA1 | PIRQA2 | PIRQA3 |
| PCIX4 slot (riser slot B) | PIRQA4 | PIRQA0 | PIRQA1 | PIRQA2 |
| PCIX4 slot (riser slot C) | PIRQA5 | PIRQA3 | PIRQA1 | PIRQA2 |
| PCI1 slot | PIRQA | PIRQB | PIRQC | PIRQD |
| PCI2 slot | PIRQH | PIRQD | PIRQB | PIRQC |
| Onboard 82540 controller | PIRQE | — | — | — |
| Onboard 82544GC controller | PIRQA8 | — | — | — |
| Onboard SCSI controller* | PIRQB8 | PIRQB9 | — | — |
| Onboard VGA controller | PIRQF | — | — | — |
| Onboard P64H2 controller | PIRQG | — | — | — |

*Available only on PU-DLS model.



PIRQA~H are ICH3 interrupt inputs.
PIRQA_n~B_n are P64H2 PCI A/B interrupt inputs.



When using PCI cards on shared slots, ensure that the drivers support “Share IRQ” or that the cards do not need IRQ assignments. Otherwise, conflicts will arise between the two PCI groups, making the system unstable and the card inoperable.

2.6.3 PCI slots

This motherboard implements the PCI-X (Peripheral Component Interconnect Extended) bus technology to support up to 133MHz data transfers, or about 1.06GB/s. This bus technology is primarily designed for servers to increase the performance of high bandwidth devices such as Ultra320 SCSI. PCI-X is backward compatible with the earlier PCI bus technology making it possible to install PCI and PCI-X cards at the same time, but the bus speed will be that of the slowest card. The following figure shows the four PCI-X slots and two PCI slots on the motherboard.

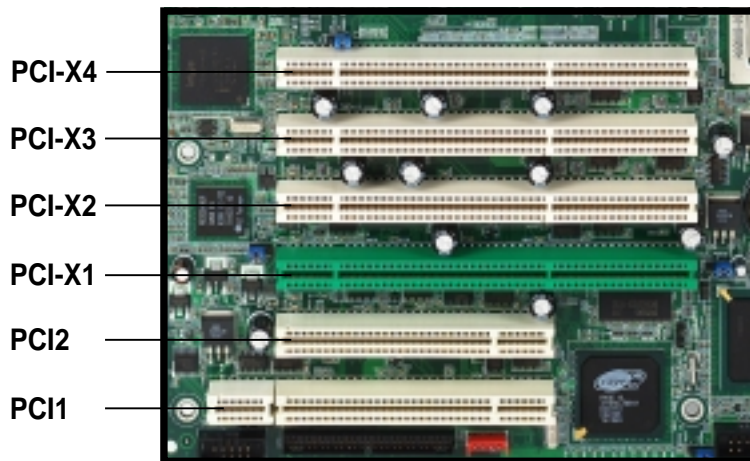

The PCI-X1 slot on PU-DL models is colored white.

PCI-X slots (PCI X1 to X4)

The PCI-X bus speeds vary depending on the number of expansion cards installed on the slots.

| PCI Bus | Onboard device | Card installed | PCI-X bus speed |
|-----------|---|-----------------------------------|-----------------|
| Channel A | Intel 82544GC PCI-X LAN | None | 133 MHz |
| | | One (on PCI-X3 or PCI-X4) | 100 MHz |
| | | Two (on PCI-X3 and PCI-X4) | 66 MHz |
| Channel B | Adaptec AIC-7902W PCI-X Ultra-320 SCSI | None | 133 MHz |
| | | One (on PCI-X1 or PCI-X2) | 100 MHz |
| | | Two (on PCI-X1 and PCI-X2) | 66 MHz |

* PCI-X1 slot on PU-DLS models supports a ZCR (Zero Channel RAID) card. ZCR functions are not supported on PU-DL models. See section "2.8 Connectors" for more information on this slot.



PCI Bus Channel B as illustrated above applies only on PU-DLS models.

PCI1/PCI2 slots

PCI1 and PCI2 are 32-bit/33MHz 5V PCI slots. PCI1 has a Low Pin Count (LPC) signal connector to accommodate the ASUS Server Management Card. The PCI bus speed for these slots is fixed at 33MHz.

2.7 Jumpers



Keep the default settings for stable system operation.

1. CPU external frequency selection (J16)

This jumper allows you to select your desired CPU external frequency (or bus clock).

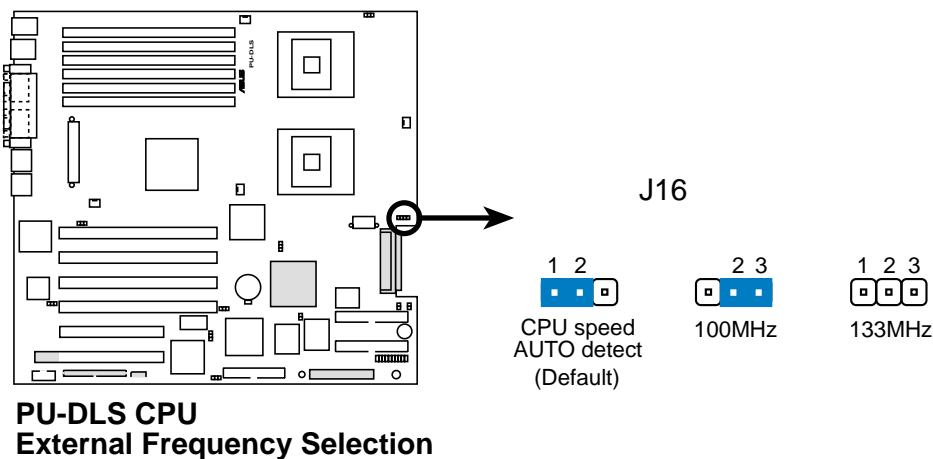

2. SCSI setting (J13)

This jumper allows you to enable or disable the onboard SCSI feature. Set to pins 1-2 if you wish to install SCSI devices. Set to pins 2-3 to disable the onboard SCSI controller.

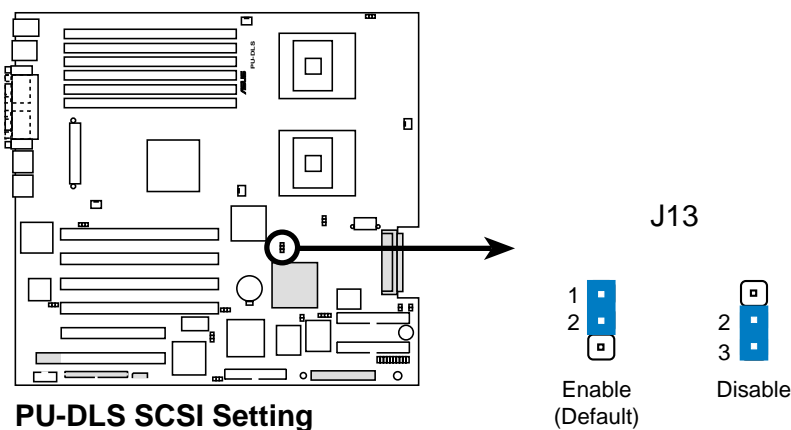

The SCSI setting jumper (J13) is present only on PU-DLS models.

3. PCI-X Gigabit LAN setting (J15)

Set this jumper to pins 1-2 to enable the onboard Intel® 82544GC Gigabit Ethernet controller. This controller supports up to 1000MBps data rates, and is optimized for LAN On Motherboard (LOM) designs, enterprise networking, and devices that use PCI or PCI-X bus. Set to pins 2-3 to disable the controller.

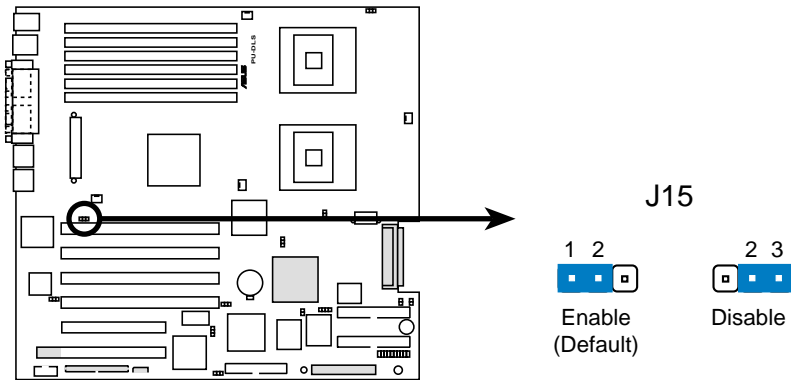

PU-DLS 64BIT 1G LAN Setting

4. 32-bit Gigabit LAN setting (J1)

Set this jumper to pins 1-2 to enable the onboard Intel 82540EM 32-bit Gigabit Ethernet controller and support 10/100/1000 Mbps networking. Set to pins 2-3 to disable the controller.

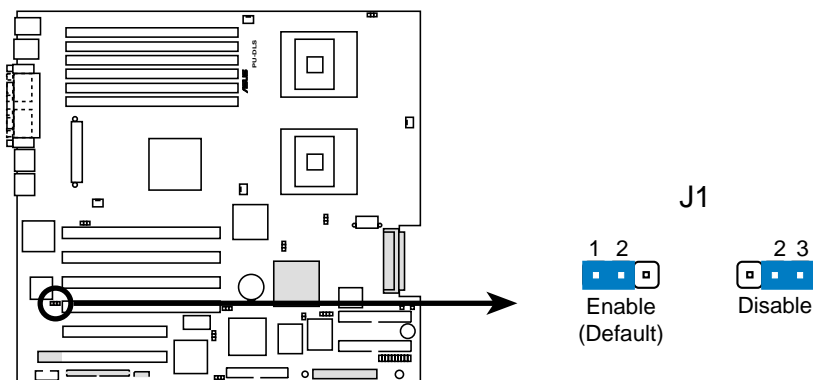

PU-DLS Intel 82540 LAN Chip Setting

5. Keyboard wake-up setting (J14)

Set this jumper to pins 1-2 to disable the keyboard wake-up feature.
Set to pins 2-3 to enable the wake-up feature.

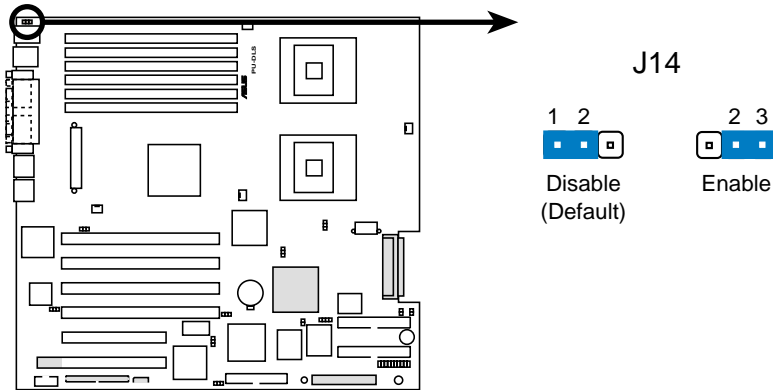

PU-DLS Keyboard WAKE-UP Setting

6. Onboard VGA setting (J2)

This jumper allows you to enable or disable the onboard VGA feature.
Set to pins 1-2 to disable the onboard VGA controller if you wish to
install a VGA card. Set to pins 2-3 to enable the onboard VGA feature.

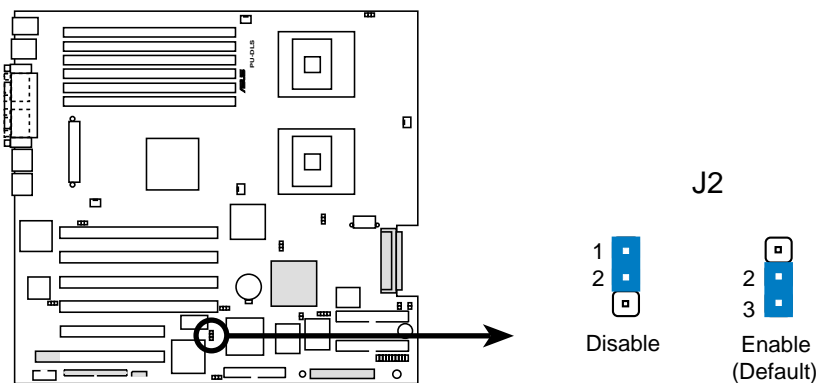

PU-DLS ATI RageXL VGA Setting

7. Clear RTC RAM (J3)

This jumper allows you to clear the Real Time Clock (RTC) RAM in CMOS. You can clear the CMOS memory of date, time, and system setup parameters by erasing the CMOS RTC RAM data. The RAM data in CMOS, that include system setup information such as system passwords, is powered by the onboard button cell battery.

To erase the RTC RAM:

1. Turn OFF the computer and unplug the power cord.
2. Move the jumper cap from pins 2-3 (default) to pins 1-2. Keep the cap on pins 1-2 for about 5~10 seconds, then move the cap back to pins 2-3.
3. Plug the power cord and turn ON the computer.
4. Hold down the key during the boot process and enter BIOS setup to re-enter data.



Except when clearing the RTC RAM, never remove the cap on CLRTC jumper default position. Removing the cap will cause system boot failure!

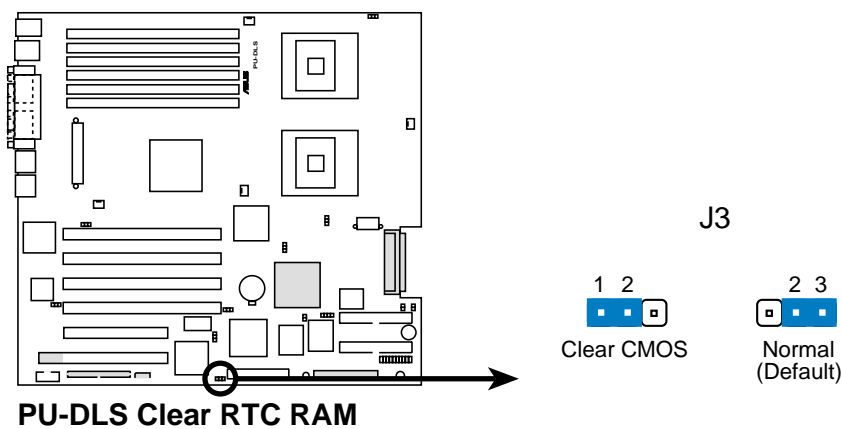

2.8 Connectors

This section describes and illustrates the internal connectors on the motherboard.



Always connect ribbon cables with the red stripe to Pin 1 on the connectors. Pin 1 is usually on the side closest to the power connector on hard drives and CD-ROM drives, but may be on the opposite side on floppy disk drives.

1. Floppy disk drive connector (34-1 pin FLOPPY1)

This connector supports the provided floppy drive ribbon cable. After connecting one end to the motherboard, connect the other end to the floppy drive. (Pin 5 is removed to prevent incorrect insertion when using ribbon cables with pin 5 plug).

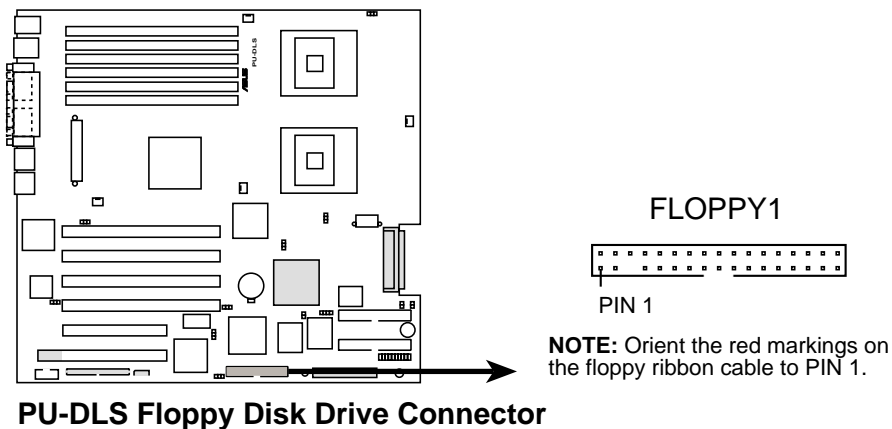

2. Serial port 2 connector (10-1 pin COM2)

This connector accommodates a second serial port using an optional serial port bracket. Connect the bracket cable to this connector then install the bracket into a slot opening at the back of the system chassis.

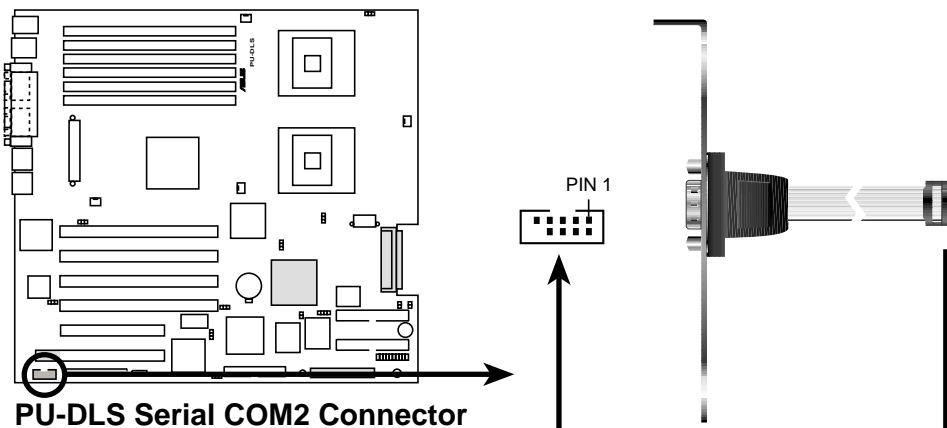

3. IDE connectors (40-1 pin IDE1, IDE2)

This connector supports the provided UltraDMA/100/66 IDE hard disk ribbon cable. Connect the cable's blue connector to the primary (recommended) or secondary IDE connector, then connect the gray connector to the UltraDMA/100/66 slave device (hard disk drive) and the black connector to the UltraDMA/100/66 master device. It is recommended that you connect non-UltraDMA/100/66 devices to the secondary IDE connector. If you install two hard disks, you must configure the second drive as a slave device by setting its jumper accordingly. Refer to the hard disk documentation for the jumper settings. BIOS supports specific device bootup. If you have more than two UltraDMA/100/66 devices, purchase another UltraDMA/100/66 cable. You may configure two hard disks to be both master devices with two ribbon cables – one for the primary IDE connector and another for the secondary IDE connector.



1. Pin 20 on each IDE connector is removed to match the covered hole on the UltraDMA cable connector. This prevents incorrect orientation when you connect the cables.
2. The hole near the blue connector on the UltraDMA/100/66 cable is intentional.

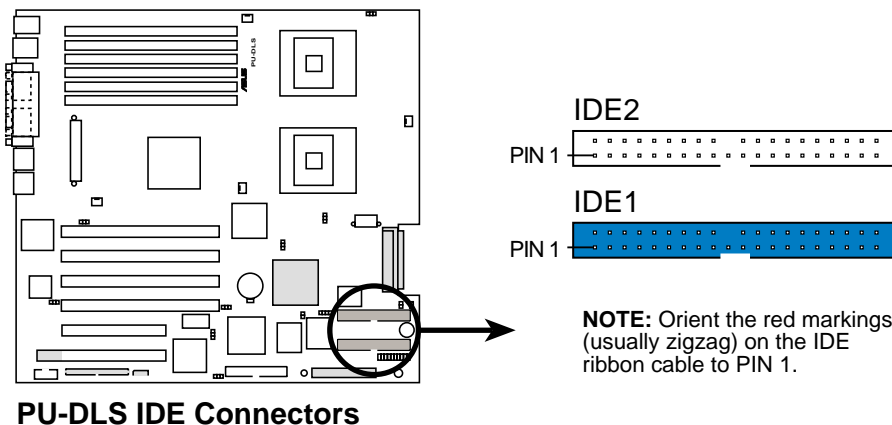

For UltraDMA/100/66 IDE devices, use an 80-conductor IDE cable. The UltraDMA/66 cable included in the motherboard package also supports UltraDMA/100.

4. SSI/ATX power connectors (24/20-pin U21, 8/4-pin U58)

These connectors connect to an SSI/ATX power supply. The plugs from the power supply are designed to fit these connectors in only one orientation. Find the proper orientation and push down firmly until the connectors completely fit.

In addition to the 24/20-pin SSI/ATXPWR connector (U21), this motherboard requires that you connect the 8/4-pin SSI12V/ATX12V (U58) power plug to provide sufficient power to the CPU.



Make sure that your ATX 12V power supply can provide 8A on the +12V lead and at least 1A on the +5-volt standby lead (+5VSB). The minimum recommended wattage is 230W, or 300W for a fully configured system. The system may become unstable and may experience difficulty powering up if the power supply is inadequate.

If you do not connect the 8/4-pin SSI/ATX12V power connector, the system cannot boot up.

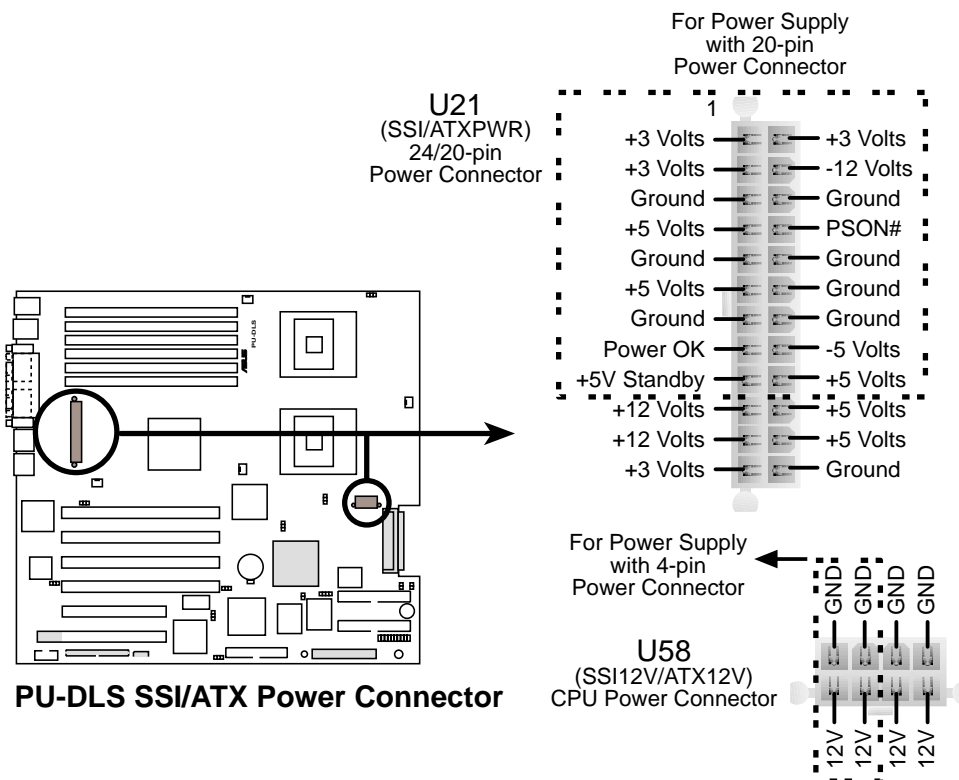

5. Two 68-pin Ultra320 SCSI Connectors (U54, U69)

This motherboard has two 68-Pin Ultra320 SCSI connectors; one for each of the two channels. Each channel can support a maximum of 15 devices as specified by Ultra320 standards.

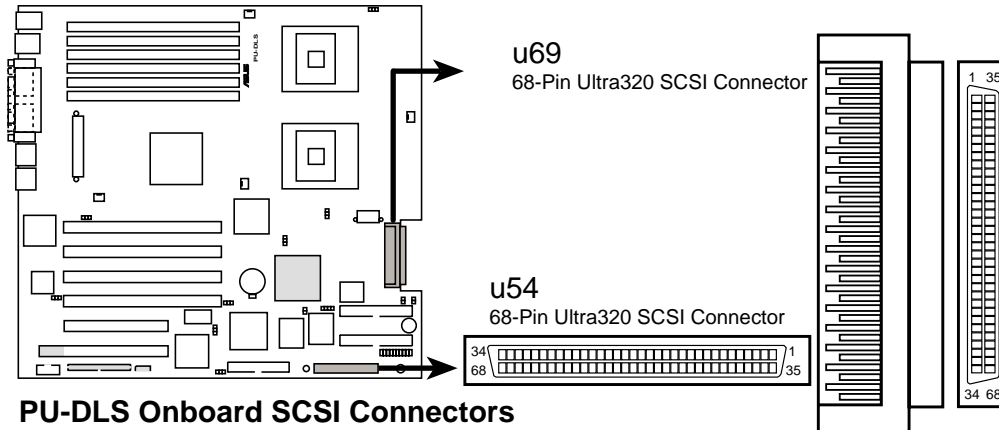

PU-DLS Onboard SCSI Connectors



The onboard SCSI connectors are available only on PU-DLS models.

SCSI Connection Notes

The PU-DLS motherboard has two 68-Pin Ultra320 SCSI connectors; one for each of the two channels.

The onboard SCSI chipset incorporates an advanced multi-mode I/O cell that supports both single-ended (SE), Ultra2, Ultra160, and Ultra320 devices. With Ultra320 devices, the SCSI bus platform performs at full Ultra320 speeds (up to 320MB/s) and extended cabling 12m (or 25m in a point-to-point configuration). When an SE device is attached, the bus defaults to an SE speed and 1.5m cable length.



Connect SCSI devices as shown. Each channel should have only one type of SCSI standard (e.g. Ultra320, Ultra160, Ultra2, Ultra-Wide). Mixing SCSI devices on the same channel decreases performance of the slower device.

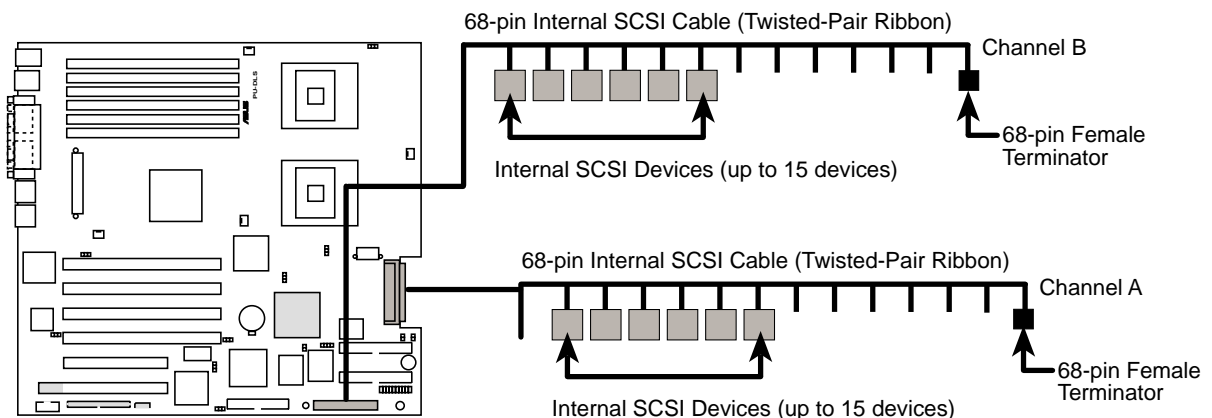

PU-DLS SCSI Connection Example

6. CPU, Chassis, and Power Fan Connectors (3-pin CPU_FAN1, CPU_FAN2, CHASSIS_FAN1, CHASSIS_FAN2)

The fan connectors support cooling fans of 350mA~740mA (8.88W max.) or a total of 1A~2.22A (26.64W max.) at +12V. Connect the fan cables to the fan connectors on the motherboard, making sure that the black wire of each cable matches the ground pin of the connector.



Do not forget to connect the fan cables to the fan connectors. Lack of sufficient air flow within the system may damage the motherboard components. These are not jumpers! **DO NOT** place jumper caps on the fan connectors!

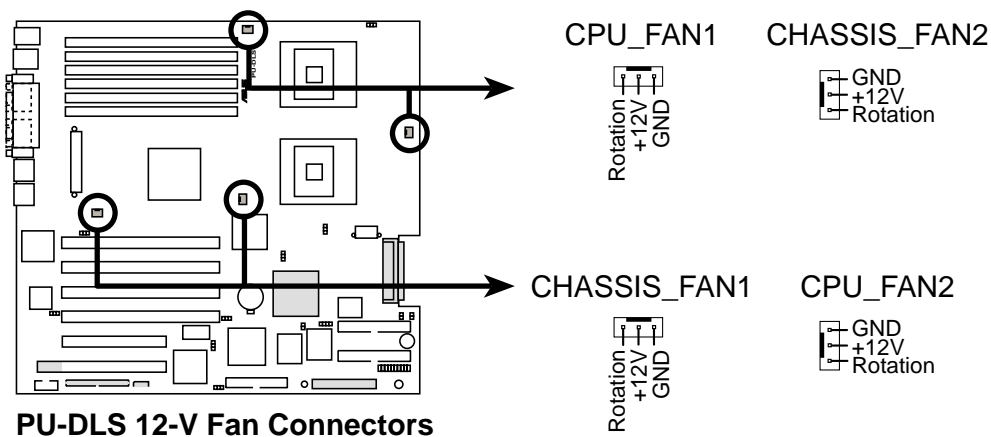

7. Wake-On-Ring Connector (2-pin WOR1)

This connector connects to internal modem cards with a Wake-On-Ring output. The connector powers up the system when a ringup packet or signal is received through the internal modem card.



For external modems, Wake-On-Ring is detected through the COM port.

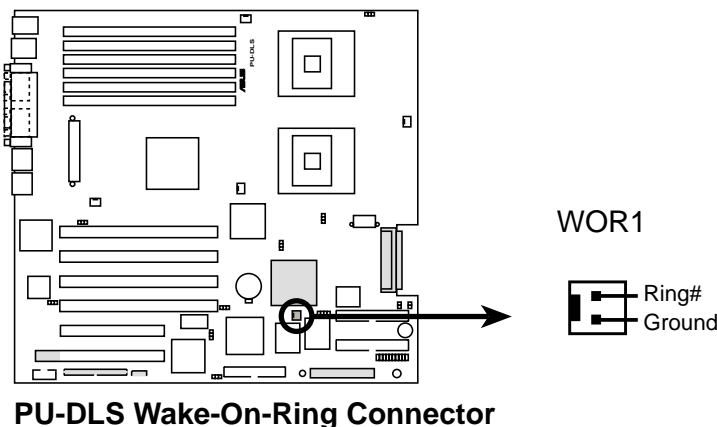

8. Server management card connector (50-pin CON1)

This connector allows you to connect the optional ASMC-LE, ASMC-ME, or ASMC-HE card using an ASMC interface cable. Install the ASMC card into the PCI1 slot and connect the cable from the card to this connector. The PCI1 slot on the motherboard has a Low Pin Count (LPC) signal connector to accommodate the ASMC card.

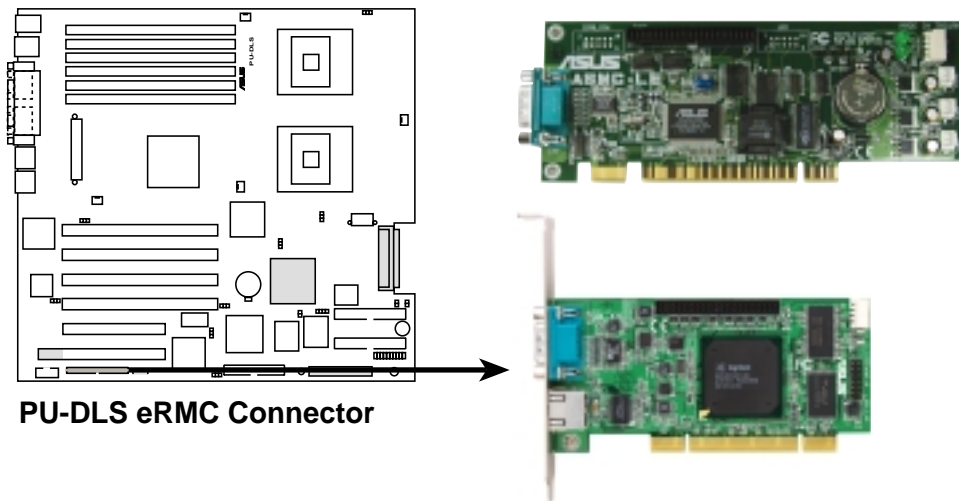

9. IPMI connector (4-pin CON2)

The Intelligent Platform Management Interface (IPMI) connector is for the ASMC card. Connect the 4-pin ASMC interface cable to this connector.

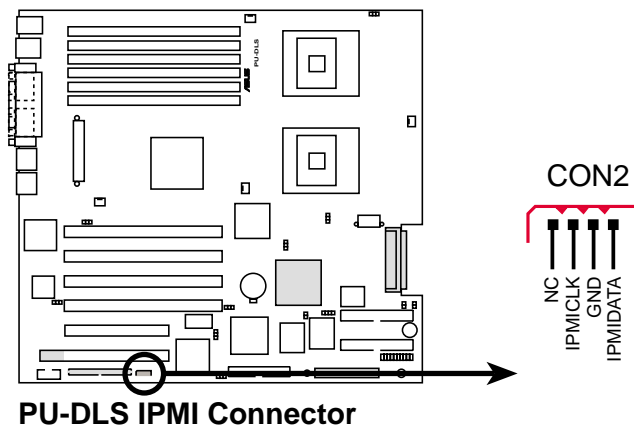

10. SMBus connector (6-1 pin J5)

This connector allows you to connect SMBus (System Management Bus) devices. Devices communicate with an SMBus host and/or other SMBus devices using the SMBus interface. SMBus is a specific implementation of an I²C bus, a multi-device bus that allows multiple chips to connect to the same bus and enable each one to act as a master by initiating data transfer.

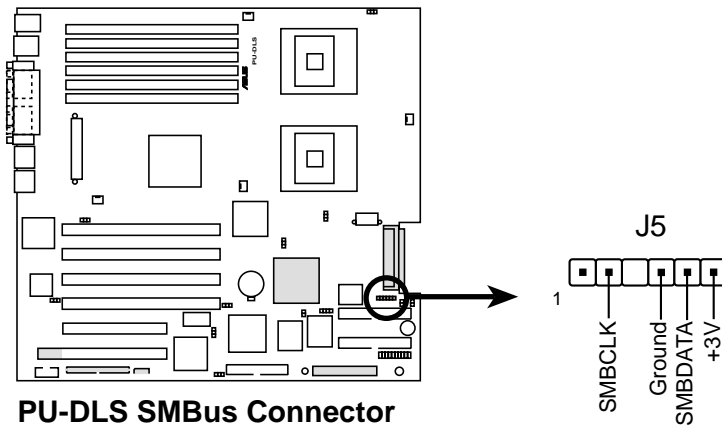

11. Zero Channel RAID slot (PCIX1)

The 64-bit/100MHz PCI-X slot (colored green on PU-DLS, colored white on PU-DL) supports the Adaptec Nighthawk2 ASR-2010S Zero-Channel RAID card or the Intel RAID Controller SRCZCR to provide advanced RAID functionality. The RAID card supports RAID levels 0, 1, 5, multilevel 0/1 and 0/5, cache memory modules with ECC, and predictive caching capability.

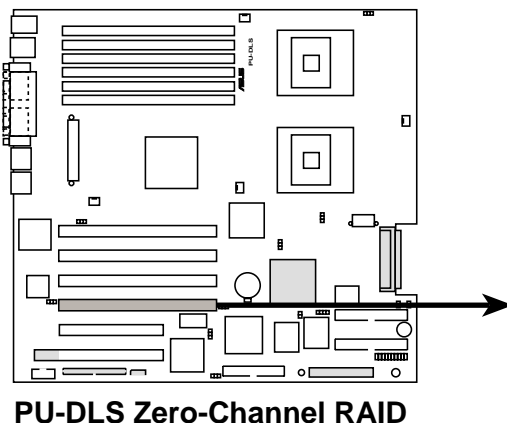

Zero Channel RAID (ZCR) functions are not supported on PU-DL models. PU-DL motherboards support other PCI-X add-on cards on the PCIX1.

12. Chassis alarm lead (4-1 pin J6)

This lead is for a chassis designed with intrusion detection feature. This requires an external detection mechanism such as a chassis intrusion sensor or microswitch. When you remove any chassis component, the sensor triggers and sends a high-level signal to this lead to record a chassis intrusion event.

By default, the pins labeled “Chassis Signal” and “Ground” are shorted with a jumper cap. If you wish to use the chassis intrusion detection feature, remove the jumper cap from the pins.

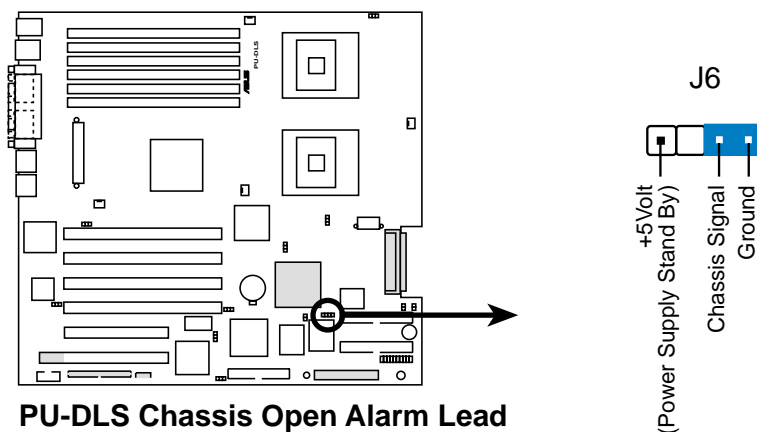

PU-DLS Chassis Open Alarm Lead

13. System panel connector (20-pin PANEL)

This connector accommodates several system front panel functions.

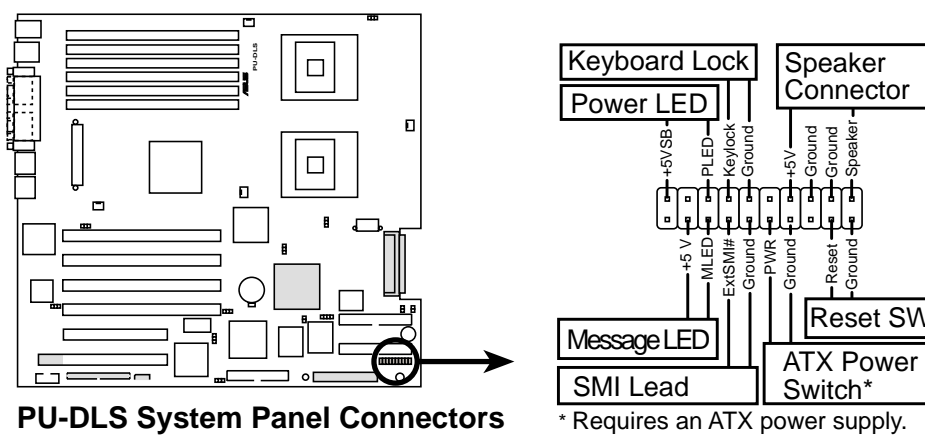

PU-DLS System Panel Connectors

- **System Power LED Lead (3-1 pin PLED)**

This 3-1 pin connector connects to the system power LED. The LED lights up when you turn on the system power, and blinks when the system is in sleep mode.
- **System Message LED Lead (2-pin MLED)**

This 2-pin connector is for the system message LED that indicates receipt of messages from a fax/modem. The normal status for this LED is OFF, when there is no incoming data signal. The LED blinks when data is received. The system message LED feature requires an ACPI OS and driver support.
- **System Warning Speaker Lead (4-pin SPEAKER)**

This 4-pin connector is for a chassis-mounted speaker.
- **ATX Power Switch / Soft-Off Switch Lead (2-pin PWR)**

This connector connects a switch that controls the system power. Pressing the power switch turns the system between ON and SLEEP, or ON and SOFT OFF, depending on the BIOS or OS settings. Pressing the power switch while in the ON mode for more than 4 seconds turns the system OFF.
- **Reset Switch Lead (2-pin RESET)**

This 2-pin connector connects to the case-mounted reset switch for rebooting the system without turning off the system power.
- **System Management Interrupt Lead (2-pin SMI)**

This lead connects to the case-mounted suspend switch, and allows you to manually place the system into “Suspend Mode” or “Green Mode” where system activity is decreased to save electricity and expand the life of system components.
- **Keylock Lead (2-pin KEYLOCK)**

This lead connects to a chassis-mounted switch to allow use of the keyboard lock feature.

Chapter 3

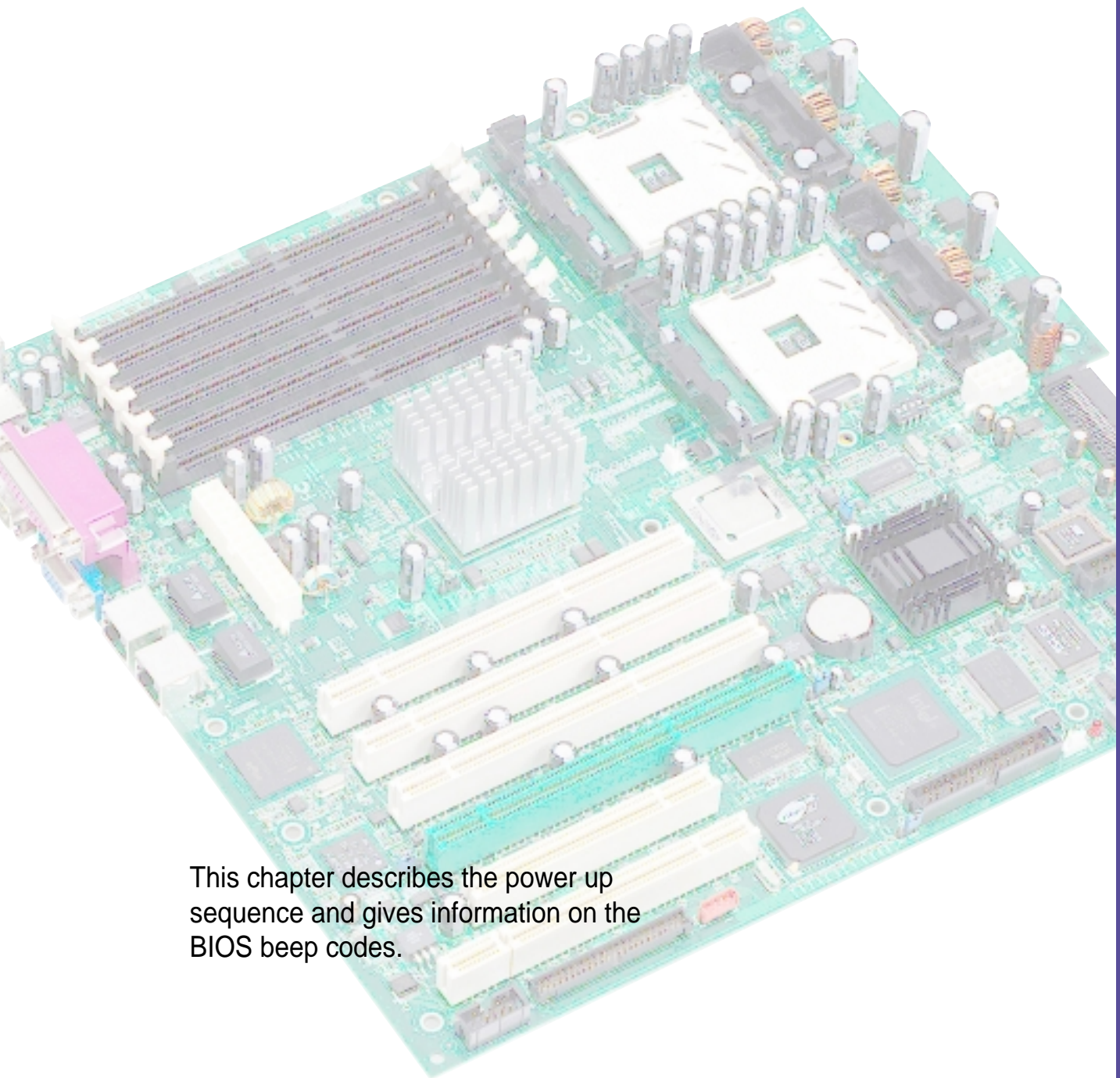

This chapter describes the power up sequence and gives information on the BIOS beep codes.

Powering up

Chapter summary

- 3.1 Starting up for the first time 3-1**
- 3.2 Powering off the computer 3-2**

3.1 Starting up for the first time

1. After making all the connections, replace the system case cover.
2. Be sure that all switches are off.
3. Connect the power cord to the power connector at the back of the system chassis.
4. Connect the power cord to a power outlet that is equipped with a surge protector.
5. Turn on the devices in the following order:
 - a. Monitor
 - b. External SCSI devices (starting with the last device on the chain)
(For PU-DLS models only.)
 - c. System power (if you are using an ATX power supply, you need to switch on the power supply as well as press the ATX power switch on the front of the chassis).
6. After applying power, the power LED on the system front panel case lights up. For ATX power supplies, the system LED lights up when you press the ATX power switch. If your monitor complies with “green” standards or if it has a “power standby” feature, the monitor LED may light up or switch between orange and green after the system LED turns on. The system then runs the power-on tests. While the tests are running, the BIOS beeps or additional messages appear on the screen. If you do not see anything within 30 seconds from the time you turned on the power, the system may have failed a power-on test. Check the jumper settings and connections or call your retailer for assistance.

Award BIOS Beep Codes

| Beep | Meaning |
|---|--|
| One short beep when displaying logo | No error during POST |
| Long beeps in an endless loop | No DRAM installed or detected |
| One long beep followed by three short beeps | Video card not found or video card memory bad |
| High frequency beeps when system is working | CPU overheated; System running at a lower frequency |

7. At power on, hold down <Delete> to enter BIOS Setup. Follow the instructions in Chapter 4.

3.2 Powering off the computer

You must first exit the operating system and shut down the system before switching off the power. For ATX power supplies, you can press the ATX power switch after exiting or shutting down the operating system. If you use Windows 2000/XP, click the Start button, click Shut Down, then click the OK button to shut down the computer. The power supply should turn off after Windows shuts down.



The message “You can now safely turn off your computer” does not appear when shutting down with ATX power supplies.

Chapter 4

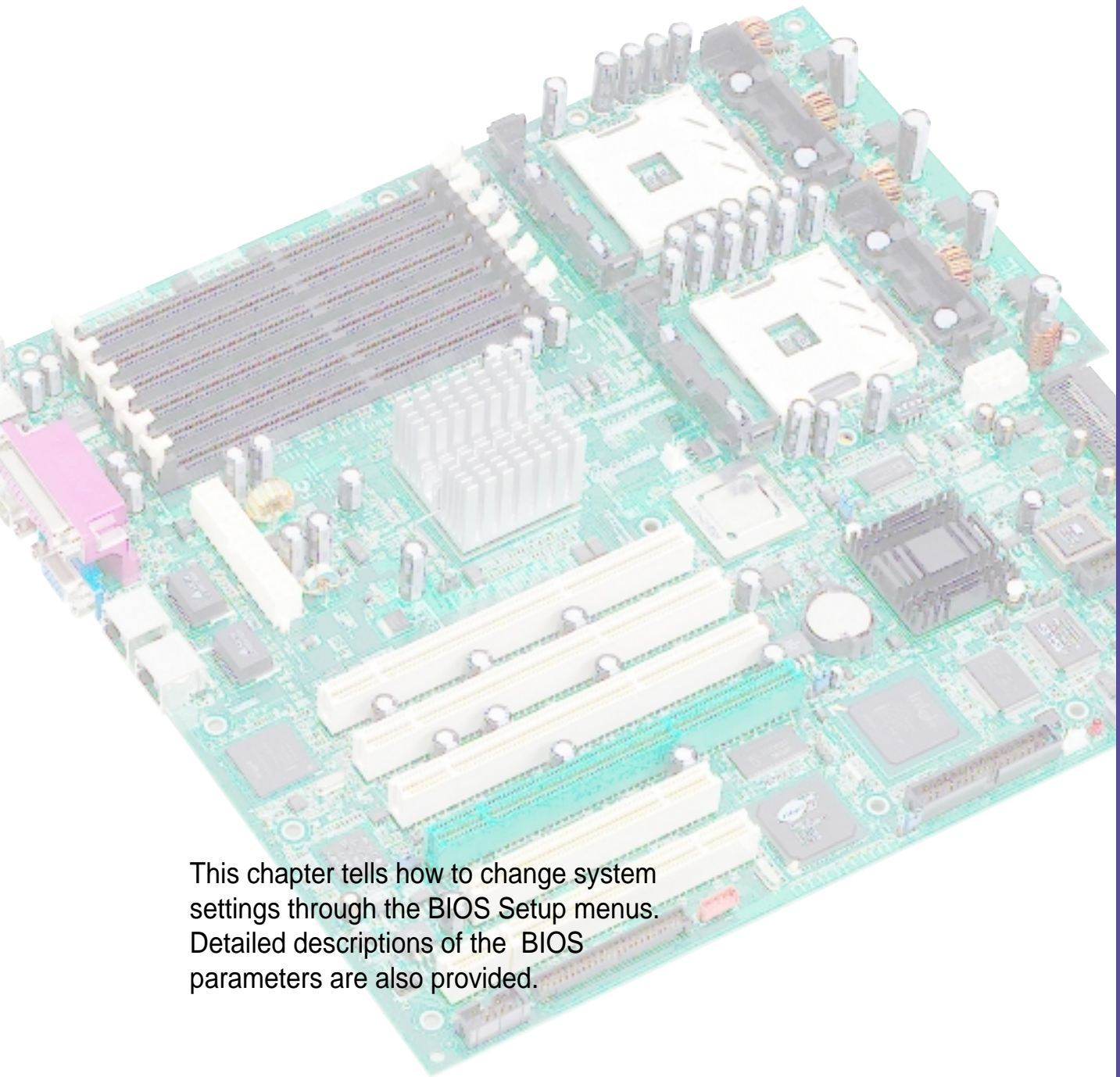

This chapter tells how to change system settings through the BIOS Setup menus. Detailed descriptions of the BIOS parameters are also provided.

BIOS setup

Chapter summary

| | | |
|------------|--|-------------|
| 4.1 | Managing and updating your BIOS | 4-1 |
| 4.2 | BIOS Setup program | 4-5 |
| 4.3 | Main Menu | 4-8 |
| 4.4 | Advanced Menu | 4-15 |
| 4.5 | Power Menu | 4-23 |
| 4.6 | Boot Menu | 4-28 |
| 4.7 | Server Menu | 4-30 |
| 4.8 | Exit Menu | 4-31 |

4.1 Managing and updating your BIOS

4.1.1 Creating a bootable disk

AFLASH.EXE is a Flash Memory Writer utility that updates the BIOS by uploading a new BIOS file to the programmable firmware hub (FWH) on the motherboard. This file works only in DOS mode. To determine the BIOS version of your motherboard, check the last four numbers of the code displayed on the upper left-hand corner of your screen during bootup. Larger numbers represent a newer BIOS file.

1. Type `FORMAT A:/S` at the DOS prompt to create a bootable system disk. DO NOT copy `AUTOEXEC.BAT` and `CONFIG.SYS` to the disk.
2. Type `COPY D:\AFLASH\AFLASH.EXE A:\` (assuming D is your CD-ROM drive) to copy `AFLASH.EXE` to the boot disk you created.



AFLASH works only in DOS mode. It does not work in the DOS prompt within Windows, and does not work with certain memory drivers that may be loaded when you boot from the hard drive. It is recommended that you reboot using a floppy disk.

3. Reboot the computer from the floppy disk.



BIOS setup must specify “Floppy” as the first item in the boot sequence.

4. In DOS mode, type `A:\AFLASH <Enter>` to run AFLASH.

```
ASUS ACPI BIOS
FLASH MEMORY WRITER V2.8
Copyright (C) 1994-2001 ASUSTeK COMPUTER INC.

Flash Memory: Winbond W29C02B or SST 29EE020 or Intel 020H20E

Current BIOS Version: ASUS XXX-XX ACPI BIOS Revision 100X
BIOS Model          : XXX-XX
BIOS Built Date     : 12/25/81

Choose one of the followings:
1. Save Current BIOS To File
2. Update BIOS Including Boot Block and ESCD

Enter choice: [1]

Press ESC To Exit
```



If the word “unknown” appears after Flash Memory:, the memory chip is either not programmable or is not supported by the ACPI BIOS and therefore, cannot be programmed by the Flash Memory Writer utility.

5. Select 1. Save Current BIOS to File from the Main menu and press <Enter>. The Save Current BIOS To File screen appears.

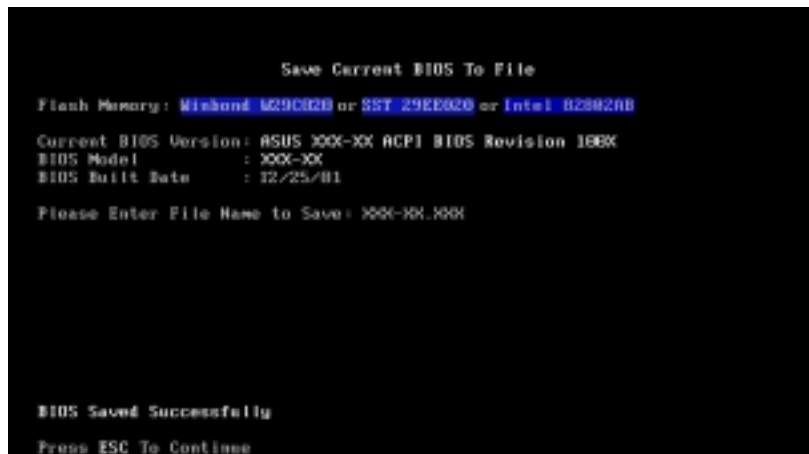

6. Type a filename and the path, for example, A:\XXX-XX.XXX, then press <Enter>.

4.1.2 Updating the BIOS



Update the BIOS only if you have problems with the motherboard and you are sure that the new BIOS revision will solve your problems. Careless updating may result to more problems with the motherboard!

1. Download an updated ASUS BIOS file from the ASUS website (www.asus.com) and save to the boot floppy disk you created earlier.
2. Boot from the floppy disk.
3. At the "A:\:" prompt, type AFLASH and then press <Enter>.
4. At the Main Menu, type 2 then press <Enter>. The Update BIOS Including Boot Block and ESCD screen appears.
5. Type the filename of your new BIOS and the path, for example, A:\XXX-XX.XXX, then press <Enter>.

To cancel this operation, press <Enter>.

```
Update BIOS Including Boot Block and ESCD
Flash Memory: Winbond W29C02B or SST 2512820 or Intel B27H2AE
Current BIOS Version: ASUS XXX-XX ACPI BIOS Revision 100X
BIOS Model          : XXX-XX
BIOS Built Date     : 12/25/01
Please Enter File Name for NEW BIOS: A:\XXX-XX.XXX
```

6. When prompted to confirm the BIOS update, press Y to start the update.

```
Update BIOS Including Boot Block and ESCD
Flash Memory: Winbond W29C02B or SST 2512820 or Intel B27H2AE
BIOS Version
(CURRENT) ASUS XXX-XX ACPI BIOS Revision 100X
(test.ow) ASUS XXX-XX ACPI BIOS Revision 100X
BIOS Model
(CURRENT) XXX-XX
(test.ow) XXX-XX
Date of BIOS Built
(CURRENT) 05/25/00
(XXXX.XXX) 05/29/00
Check sum of 1001.010 is F266.
Are you sure (Y/N) ? [Y]
Press ESC To Return to Main Menu
```

7. The utility starts to program the new BIOS information into the Flash ROM. The boot block is updated automatically only when necessary. This minimizes the possibility of boot problems in case of update failures. When the programming is done, the message “*Flashed Successfully*” appears.

```
Update BIOS Including Boot Block and ESCD

Flash Memory: Winbond W29C020 or SST 29EE020 or Intel B2802AB

BIOS Version
(CURRENT) ASUS XXX-XX ACPI BIOS Revision 180X
(test.amd) ASUS XXX-XX ACPI BIOS Revision 180X

BIOS Model
(CURRENT) XXX-XX
(test.amd) XXX-XX

Date of BIOS Built
(CURRENT) 12/25/01
(XXXX.XXXX) 05/29/00

Check sum of 1801.B10 is F266.

Are you sure (Y/N) ? Y
Block Erasing -- Done
Programming -- 3FFF
Flashed Successfully

Press ESC To Continue
```

8. Follow the onscreen instructions to continue.

```
ASUS ACPI BIOS
FLASH MEMORY WRITER V2.0
Copyright (C) 1994-2001 ASUSTeK COMPUTER INC.

Flash Memory: Winbond W29C020 or SST 29EE020 or Intel B2802AB

Current BIOS Version: ASUS XXX-XX ACPI BIOS Revision 180X
BIOS Model : XXX-XX
BIOS Built Date : 12/25/01

Choose one of the following:

1. Save Current BIOS To File
2. Update BIOS Including Boot Block and ESCD

Enter choice: [1]

You have flashed the EPROM. It is recommended that you turn off
the power, enter SETUP and Load Setup Defaults to have CMOS
updated with new BIOS when exits.

Press ESC To Exit
```



If you encounter problems while updating the new BIOS, DO NOT turn off the system because this may cause boot problems. Just repeat the process, and if the problem persists, load the original BIOS file you saved to the boot disk. If the Flash Memory Writer utility is not able to successfully update a complete BIOS file, the system may not boot. If this happens, call the ASUS service center for support.

4.2 BIOS Setup program

This motherboard supports a programmable firmware hub (FWH) that you can update using the provided utility described in section “4.1 Managing and updating your BIOS.”

Use the BIOS Setup program when you are installing a motherboard, reconfiguring your system, or prompted to “Run Setup”. This section explains how to configure your system using this utility.

Even if you are not prompted to use the Setup program, you may want to change the configuration of your computer in the future. For example, you may want to enable the security password feature or make changes to the power management settings. This requires you to reconfigure your system using the BIOS Setup program so that the computer can recognize these changes and record them in the CMOS RAM of the FWH.

The FWH on the motherboard stores the Setup utility. When you start up the computer, the system allows you to run this program using either one of the following methods:

- Press **Delete** during the Power-On Self Test (POST) to enter the Setup utility. If you don't press Delete, POST continues with its test routines, then enter the operating system.
- Press **F6** once then press **Delete** during POST to enter Setup faster.

If you wish to enter Setup after POST, restart the system by pressing the key combination Ctrl-Alt-Delete, or by pressing the reset button on the system chassis. You can also restart by turning the system off and then back on. Do this last option only if the first two failed.

The Setup program is designed to make it as easy to use as possible. It is a menu-driven program, which means you can scroll through the various sub-menus and make your selections among the predetermined choices.



Because the BIOS software is constantly being updated, the following BIOS setup screens and descriptions are for reference purposes only, and may not exactly match what you see on your screen.

4.2.1 BIOS menu bar

The top of the screen has a menu bar with the following selections:

- MAIN** Use this menu to make changes to the basic system configuration.
- ADVANCED** Use this menu to enable and make changes to the advanced features.
- POWER** Use this menu to configure power management features.
- BOOT** Use this menu to configure the default system device used to locate and load the Operating System.
- SERVER** Use this menu to set server-related items
- EXIT** Use this menu to exit the current menu or to exit the Setup program.

To access the menu bar items, press the right or left arrow key on the keyboard until the desired item is highlighted.

4.2.2 Legend bar

At the bottom of the Setup screen is a legend bar. The keys in the legend bar allow you to navigate through the various setup menus. The following table lists the keys found in the legend bar with their corresponding functions.

| Navigation Key(s) | Function Description |
|--------------------------------------|--|
| <F1> or <Alt + H> | Displays the General Help screen from anywhere in the BIOS Setup |
| <Esc> | Jumps to the Exit menu or returns to the main menu from a sub-menu |
| Left or Right arrow | Selects the menu item to the left or right |
| Up or Down arrow | Moves the highlight up or down between fields |
| - (minus key) | Scrolls backward through the values for the highlighted field |
| + (plus key) or spacebar | Scrolls forward through the values for the highlighted field |
| <Enter> | Brings up a selection menu for the highlighted field |
| <Home> or <PgUp> | Moves the cursor to the first field |
| <End> or <PgDn> | Moves the cursor to the last field |
| <F5> | Resets the current screen to its Setup Defaults |
| <F10> | Saves changes and exits Setup |

General help

In addition to the Item Specific Help window, the BIOS setup program also provides a General Help screen. You may launch this screen from any menu by simply pressing <F1> or the <Alt> + <H> combination. The General Help screen lists the legend keys and their corresponding functions.

Saving changes and exiting the Setup program

See “4.8 Exit Menu” for detailed information on saving changes and exiting the setup program.

Scroll bar

When a scroll bar appears to the right of a help window, it indicates that there is more information to be displayed that will not fit in the window. Use <PgUp> and <PgDn> or the up and down arrow keys to scroll through the entire help document. Press <Home> to display the first page, press <End> to go to the last page. To exit the help window, press <Enter> or <Esc>.

Sub-menu

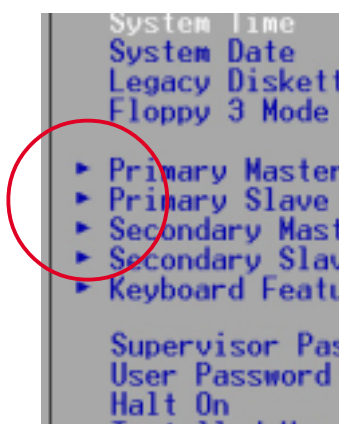

Note that a right pointer symbol (as shown on the left) appears to the left of certain fields. This pointer indicates that you can display a sub-menu from this field. A sub-menu contains additional options for a field parameter. To display a sub-menu, move the highlight to the field and press <Enter>. The sub-menu appears. Use the legend keys to enter values and move from field to field within a sub-menu as you would within a menu. Use the <Esc> key to return to the main menu.

Take some time to familiarize yourself with the legend keys and their corresponding functions. Practice navigating through the various menus and sub-menus. If you accidentally make unwanted changes to any of the fields, use the set default hot key <F5> to load the Setup default values. While moving around through the Setup program, note that explanations appear in the Item Specific Help window located to the right of each menu. This window displays the help text for the currently highlighted field.

4.3 Main Menu

When you enter the Setup program, the following screen appears.

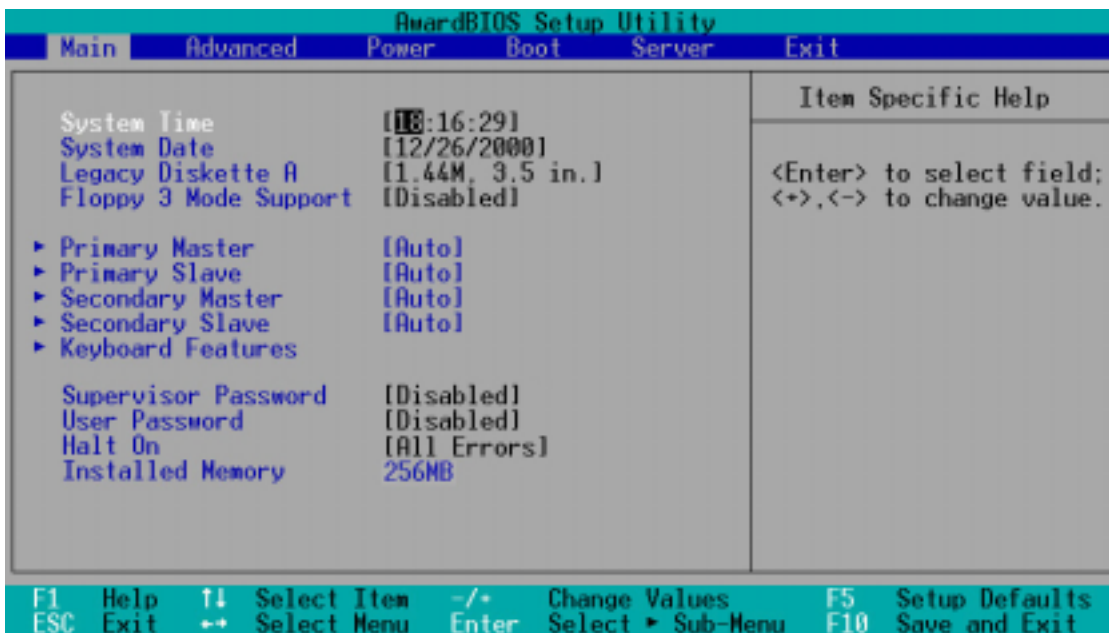

System Time [XX:XX:XX]

Sets the system to the time that you specify (usually the current time). The format is hour, minute, second. Valid values for hour, minute and second are Hour: (00 to 23), Minute: (00 to 59), Second: (00 to 59). Use the <Tab> or <Shift> + <Tab> keys to move between the hour, minute, and second fields.

System Date [XX/XX/XXXX]

Sets the system to the date that you specify (usually the current date). The format is month, day, year. Valid values for month, day, and year are Month: (1 to 12), Day: (1 to 31), Year: (up to 2099). Use the <Tab> or <Shift> + <Tab> keys to move between the month, day, and year fields.

Legacy Diskette A [1.44M, 3.5 in.]

Sets the type of floppy drive installed. Configuration options: [None] [360K, 5.25 in.] [1.2M , 5.25 in.] [720K , 3.5 in.] [1.44M, 3.5 in.] [2.88M, 3.5 in.]

Floppy 3 Mode Support [Disabled]

This is required to support older Japanese floppy drives. The Floppy 3 Mode feature allows reading and writing of 1.2MB (as opposed to 1.44MB) on a 3.5-inch diskette. Configuration options: [Disabled] [Enabled]

Supervisor Password [Disabled] / User Password [Disabled]

These fields allow you to set passwords. To set a password, highlight the appropriate field and press <Enter>. Type in a password then press <Enter>. You can type up to eight alphanumeric characters. Symbols and other characters are ignored. To confirm the password, type the password again and press <Enter>. The password is now set to [Enabled]. This password allows full access to the BIOS Setup menus. To clear the password, highlight this field and press <Enter>. The same dialog box as above appears. Press <Enter>. The password is set to [Disabled].

A note about passwords

The BIOS Setup program allows you to specify passwords in the Main menu. The passwords control access to the BIOS during system startup. Passwords are not case sensitive, meaning, passwords typed in either uppercase or lowercase letters are accepted. The BIOS Setup program allows you to specify two different passwords: a Supervisor password and a User password. If you did not set a Supervisor password, anyone can access the BIOS Setup program. If you did, the Supervisor password is required to enter the BIOS Setup program and to gain full access to the configuration fields.

Forgot the password?

If you forget your password, you can clear it by erasing the CMOS Real Time Clock (RTC) RAM. The RAM data containing the password information is powered by the onboard button cell battery. See section “2.7 Jumpers” for information on how to erase the R TC RAM.

Halt On [All Errors]

This field specifies the types of errors that will cause the system to halt. Configuration options: [All Errors] [No Error] [All but Keyboard] [All but Disk] [All but Disk/Keyboard]

Installed Memory [XXX MB]

This field automatically displays the amount of conventional memory detected by the system during the boot process.

4.3.1 Primary and Secondary Master/Slave

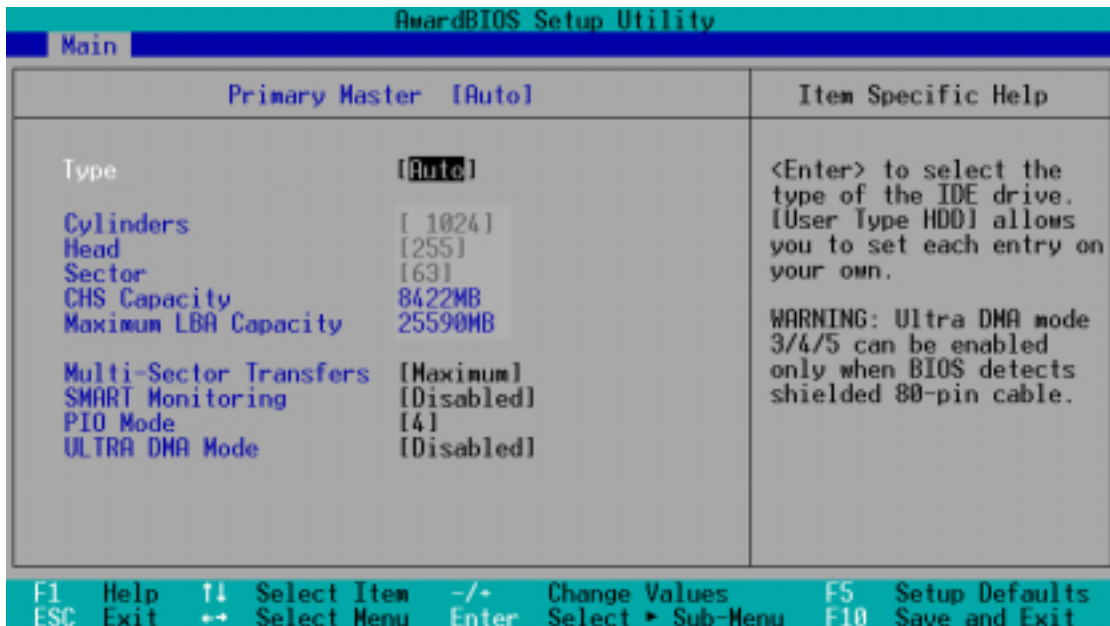

Type [Auto]

Select [Auto] to automatically detect an IDE hard disk drive. If automatic detection is successful, Setup automatically fills in the correct values for the remaining fields on this sub-menu. If automatic detection fails, this may be because the hard disk drive is too old or too new. If the hard disk was already formatted on an older system, Setup may detect incorrect parameters. In these cases, select [User Type HDD] to manually enter the IDE hard disk drive parameters. Refer to the next section for details.



Before attempting to configure a hard disk drive, make sure you have the correct configuration information supplied by the drive manufacturer. Incorrect settings may cause the system to fail to recognize the installed hard disk.

[User Type HDD]

| AwardBIOS Setup Utility | | | |
|-------------------------|-----------------|---|-------------------------|
| Main | | | |
| Primary Master | [User Type HDD] | Item Specific Help | |
| Type | [User Type HDD] | <p><Enter> to select the type of the IDE drive. [User Type HDD] allows you to set each entry on your own.</p> <p>WARNING: Ultra DMA mode 3/4/5 can be enabled only when BIOS detects shielded 80-pin cable.</p> | |
| Translation Method | [LBA] | | |
| Cylinders | [1024] | | |
| Head | [255] | | |
| Sector | [63] | | |
| CHS Capacity | 8422MB | | |
| Maximum LBA Capacity | 25590MB | | |
| Multi-Sector Transfers | [Maximum] | | |
| SMART Monitoring | [Disabled] | | |
| PIO Mode | [4] | | |
| ULTRA DMA Mode | [Disabled] | | |
| F1 Help | ↑↓ Select Item | | -/+ Change Values |
| ESC Exit | →← Select Menu | | Enter Select ▶ Sub-Menu |
| | | F5 Setup Defaults | |
| | | F10 Save and Exit | |

Manually enter the number of cylinders, heads and sectors per track for the drive. Refer to the drive documentation or on the drive label for this information.



After entering the IDE hard disk drive information into BIOS, use a disk utility, such as FDISK, to partition and format new IDE hard disk drives. This is necessary so that you can write or read data from the hard disk. Make sure to set the partition of the Primary IDE hard disk drives to active.

If no drive is installed or if you are removing a drive and not replacing it, select [None].

Other options for the Type field are:

[CD-ROM] - for IDE CD-ROM drives

[LS-120] - for LS-120 compatible floppy disk drives

[ZIP] - for ZIP-compatible disk drives

[MO] - for IDE magneto optical disk drives

[Other ATAPI Device] - for IDE devices not listed here

After making your selections on this sub-menu, press the <Esc> key to return to the Main menu. When the Main menu appears, the hard disk drive field displays the size for the hard disk drive that you configured.

Translation Method [LBA]

Select the hard disk drive type in this field. When Logical Block Addressing (LBA) is enabled, the 28-bit addressing of the hard drive is used without regard for cylinders, heads, or sectors. Note that LBA Mode is necessary for drives with more than 504MB storage capacity. Configuration options: [LBA] [LARGE] [Normal] [Match Partition Table] [Manual]

Cylinders

This field configures the number of cylinders. Refer to the drive documentation to determine the correct value. To make changes to this field, set the Type field to [User Type HDD] and the Translation Method field to [Manual].

Head

This field configures the number of read/write heads. Refer to the drive documentation to determine the correct value. To make changes to this field, set the Type field to [User Type HDD] and the Translation Method field to [Manual].

Sector

This field configures the number of sectors per track. Refer to the drive documentation to determine the correct value. To make changes to this field, set the Type field to [User Type HDD] and the Translation Method field to [Manual].

CHS Capacity

This field shows the drive's maximum CHS capacity as calculated by the BIOS based on the drive information you entered.

Maximum LBA Capacity

This field shows the drive's maximum LBA capacity as calculated by the BIOS based on the drive information you entered.

Multi-Sector Transfers [Maximum]

This option automatically sets the number of sectors per block to the highest number that the drive supports. Note that when this field is automatically configured, the set value may not always be the fastest value for the drive. You may also manually configure this field. Refer to the documentation that came with the hard drive to determine the optimum value and set it manually. To make changes to this field, set the Type field to [User Type HDD]. Configuration options: [Disabled] [2 Sectors] [4 Sectors] [8 Sectors] [16 Sectors] [32 Sectors] [Maximum]

SMART Monitoring [Disabled]

This field allows you to enable or disable the S.M.A.R.T. (Self-Monitoring, Analysis and Reporting Technology) system that utilizes internal hard disk drive monitoring technology. This parameter is normally disabled because the resources used in the SMART monitoring feature may decrease system performance. Configuration options: [Disabled] [Enabled]

PIO Mode [4]

This option lets you set a PIO (Programmed Input/Output) mode for the IDE device. Modes 0 through 4 provide successive increase in performance. Configuration options: [0] [1] [2] [3] [4]

Ultra DMA Mode [Disabled]

Ultra DMA capability allows improved transfer speeds and data integrity for compatible IDE devices. Set to [Disabled] to suppress Ultra DMA capability. To make changes to this field, set the Type field to [User Type HDD]. Configuration options: [0] [1] [2] [3] [4] [5] [Disabled]

4.3.2 Keyboard Features

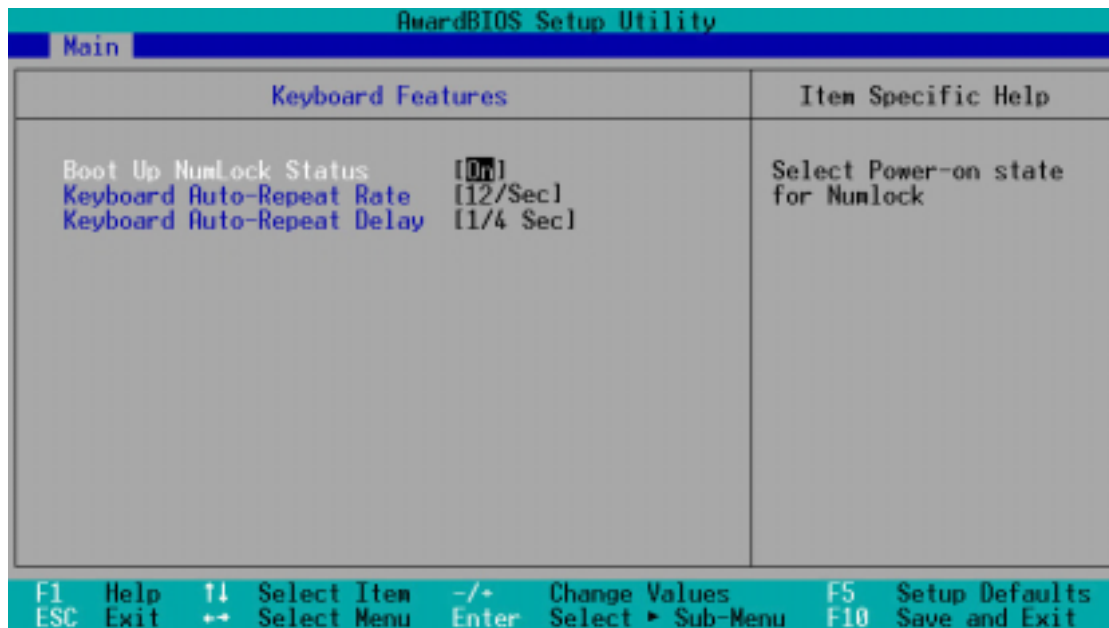

Boot Up NumLock Status [On]

This field enables users to activate the Number Lock function upon system boot. Configuration options: [Off] [On]

Keyboard Auto-Repeat Rate [12/Sec]

This controls the speed at which the system registers repeated keystrokes. Options range from 6 to 30 characters per second. Configuration options: [6/Sec] [8/Sec] [10/Sec] [12/Sec] [15/Sec] [20/Sec] [24/Sec] [30/Sec]

Keyboard Auto-Repeat Delay [1/4 Sec]

This field sets the time interval for displaying the first and second characters. Configuration options: [1/4 Sec] [1/2 Sec] [3/4 Sec] [1 Sec]

4.4 Advanced Menu

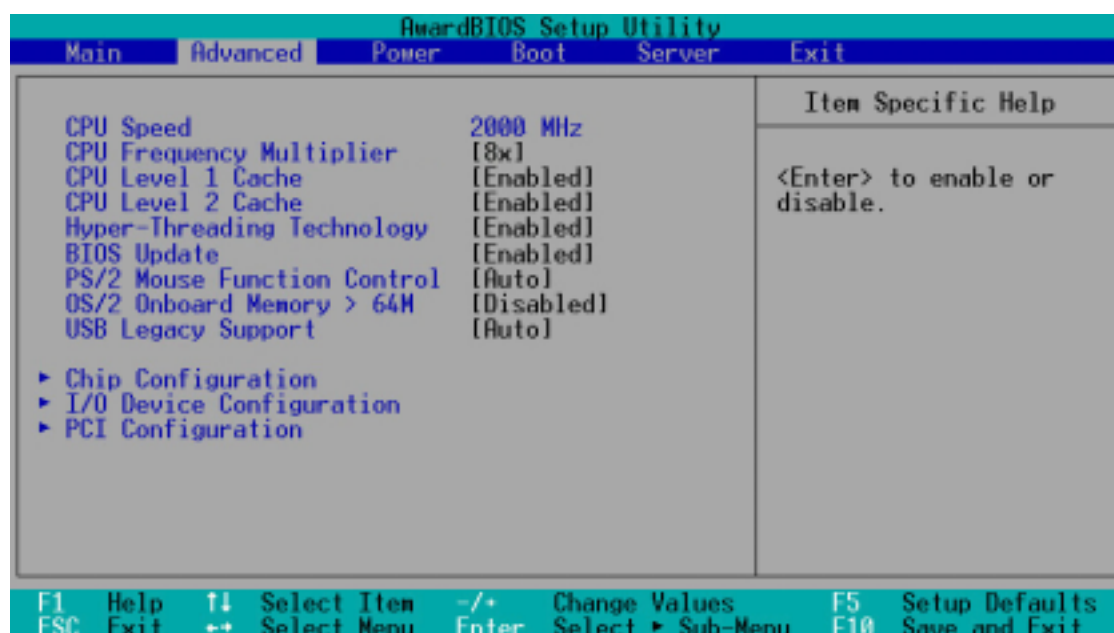

CPU Speed [Manual]

This field displays the CPU speed.

CPU Frequency Multiplier [8x] (when CPU Speed is set to [Manual])

This field sets the frequency multiple between the CPU's internal frequency (CPU speed) and external frequency. Set this field in conjunction with CPU Frequency (MHz) to match the speed of the CPU.

CPU Level 1 Cache, CPU Level 2 Cache [Enabled]

These fields allow you to choose from the default [Enabled] or choose [Disabled] to turn on or off the CPU Level 1 and Level 2 built-in cache. Configuration options: [Disabled] [Enabled]

Hyper-Threading Technology [Enabled]

This item allows you to enable or disable support for Hyper-Threading Technology enabled processors which contain multiple logical processors per physical processor package. Configuration options: [Disabled] [Enabled]

BIOS Update [Enabled]

This field functions as an update loader integrated into the BIOS to supply the processor with the required data. When set to [Enabled], the BIOS loads the update on all processors during system bootup. Configuration options: [Disabled] [Enabled]

PS/2 Mouse Function Control [Auto]

The default setting [Auto] allows the system to detect a PS/2 mouse at startup. If a mouse is detected, the BIOS assigns IRQ12 to the PS/2 mouse. Otherwise, IRQ12 can be used for expansion cards. When you set this field to [Enabled], BIOS reserves IRQ12, whether or not a PS/2 mouse is detected at startup. Configuration options: [Enabled] [Auto]

OS/2 Onboard Memory > 64M [Disabled]

When using OS/2 operating systems with installed DRAM of greater than 64MB, you need to set this option to [Enabled]. Otherwise, leave to the default setting [Disabled]. Configuration options: [Disabled] [Enabled]

USB Legacy Support [Auto]

This motherboard supports Universal Serial Bus (USB) devices. The default of [Auto] allows the system to detect a USB device at startup. If detected, the USB controller legacy mode is enabled. If not detected, the USB controller legacy mode is disabled.

When you set this field to [Disabled], the USB controller legacy mode is disabled whether or not you are using a USB device. Configuration options: [Disabled] [Enabled] [Auto]

4.4.1 Chip Configuration

| AwardBIOS Setup Utility | | |
|------------------------------|------------|--|
| Advanced | | |
| Chip Configuration | | Item Specific Help |
| SDRAM Configuration | [By SPD] | <Enter> to select SDRAM configuration. [By SPD] is recommended. [User Defined] allows you to set each configuration on your own. |
| SDRAM CAS Latency | [2.5T] | |
| SDRAM RAS to CAS Delay | [3T] | |
| SDRAM RAS Precharge Delay | [3T] | |
| SDRAM Active Precharge Delay | [6T] | |
| Video Memory Cache Mode | [UC] | |
| Memory Hole At 15M-16M | [Disabled] | |
| Delay Transaction | [Enabled] | |
| Onboard PCI IDE | [Both] | |

F1 Help ↑ Select Item -/+ Change Values F5 Setup Defaults
ESC Exit → Select Menu Enter Select ▶ Sub-Menu F10 Save and Exit

SDRAM Configuration [By SPD]

This parameter allows you to set the optimal timings for items 2–5, depending on the memory modules that you are using. The default setting is [By SPD], which configures items 2–5 by reading the contents in the SPD (Serial Presence Detect) device. The EEPROM on the memory module stores critical information about the module, such as memory type, size, speed, voltage interface, and module banks.

Configuration options: [User Defined] [By SPD]



The SDRAM parameters (items 2~5) become configurable only when you set the SDRAM Configuration to [User Defined].

SDRAM CAS Latency [2.5T]

This item controls the latency between the SDRAM read command and the time the data actually becomes available. It is recommended to keep the default setting for stable system operation.

SDRAM RAS to CAS Delay [3T]

This item controls the latency between the DDR SDRAM active command and the read/write command. It is recommended to keep the default setting for stable system operation.

SDRAM RAS Precharge Delay [3T]

This item controls the idle clocks after issuing a precharge command to the DDR SDRAM. It is recommended to keep the default setting for stable system operation.

SDRAM Active Precharge Delay [6T]

This item controls the number of DDR SDRAM clocks used for DDR SDRAM parameters. It is recommended to keep the default setting for stable system operation.

Video Memory Cache Mode [UC]

USWC (uncacheable, speculative write combining) is a new cache technology for the video memory of the processor. It can greatly improve the display speed by caching the display data. You must set this to UC (uncacheable) if your display card does not support this feature, otherwise the system may not boot. Configuration options: [UC] [USWC]

Memory Hole At 15M-16M [Disabled]

This field allows you to reserve an address space for ISA expansion cards. Setting the address space to a particular setting makes that memory space unavailable to other system components. Expansion cards can only access memory up to 16MB. Configuration options: [Disabled] [Enabled]

Delayed Transaction [Enabled]

When set to [Enabled], this feature frees the PCI bus when the CPU is accessing 8-bit LPC, FWH, and ICH3 internal registers. This process normally consumes about 50-60 PCI clocks without PCI delayed transaction. Configuration options: [Enabled] [Disabled]

Onboard PCI IDE [Both]

This field allows you to enable either the primary IDE channel or secondary IDE channel, or both. You can also set both channels to [Disabled]. Configuration options: [Both] [Primary] [Secondary] [Disabled]

4.4.2 I/O Device Configuration

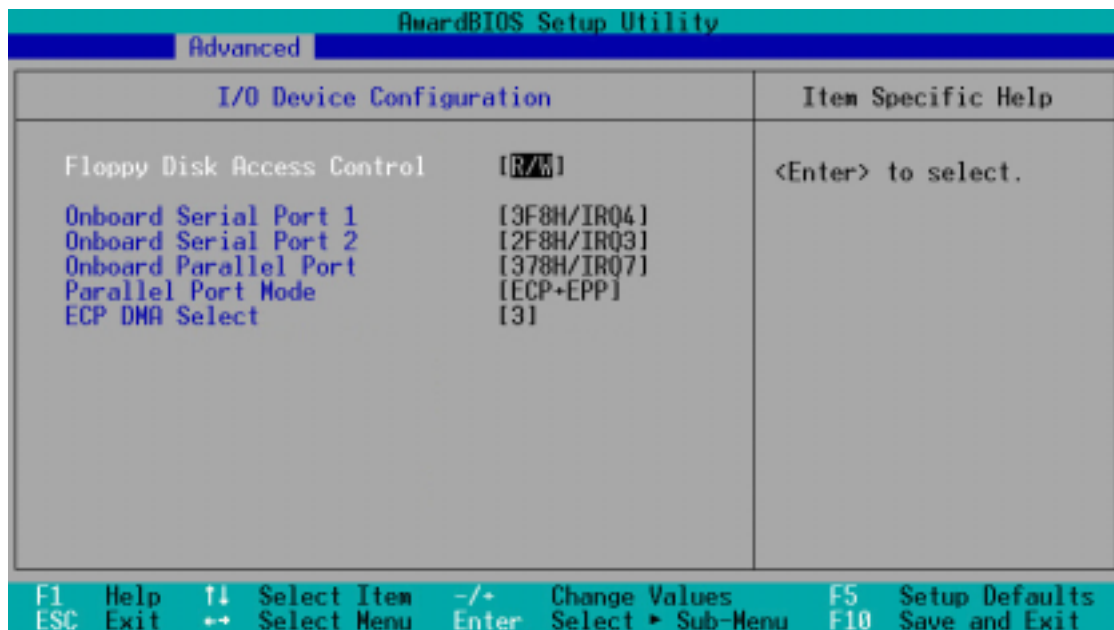

Floppy Disk Access Control [R/W]

When set to [Read Only], this parameter protects files from being copied to floppy disks by allowing reads from, but not writes to, the floppy disk drive. The default setting [R/W] allows both reads and writes. Configuration options: [R/W] [Read Only]

Onboard Serial Port 1 [3F8H/IRQ4]

Onboard Serial Port 2 [2F8H/IRQ3]

These fields allow you to set the addresses for the onboard serial connectors. Serial Port 1 and Serial Port 2 must have different addresses. Configuration options: [3F8H/IRQ4] [2F8H/IRQ3] [3E8H/IRQ4] [2E8H/IRQ10] [Disabled]

Onboard Parallel Port [378H/IRQ7]

This field allows you to set the address of the onboard parallel port connector. If you disable this field, the Parallel Port Mode and ECP DMA Select configurations are not available. Configuration options: [Disabled] [378H/IRQ7] [278H/IRQ5]

Parallel Port Mode [ECP+EPP]

This field allows you to set the operation mode of the parallel port. [Normal] allows normal-speed operation but in one direction only; [EPP] allows bidirectional parallel port operation; [ECP] allows the parallel port to operate in bidirectional DMA mode; [ECP+EPP] allows normal speed operation in a two-way mode. Configuration options: [Normal] [EPP] [ECP] [ECP+EPP]

ECP DMA Select [3]

This field allows you to configure the parallel port DMA channel for the selected ECP mode. This selection is available only if you select [ECP] or [ECP+EPP] in Parallel Port Mode above. Configuration options: [1] [3]

4.4.3 PCI Configuration



Slot 1, Slot 2, Slot 3/4/5/6/7/8 IRQ [Auto]

These fields set how IRQ use is determined for each PCI slot. The default setting for each field is [Auto], which utilizes auto-routing to determine IRQ use. Slots 1 and 2 map to PCI slot 1 and PCI slot 2. Slots 3/4/5/6/7/8 map to PCIX1/2/3/4, with PCIX4 serving riser slots A/B/C. Configuration options: [Auto] [NA] [3] [4] [5] [7] [9] [10] [11] [12] [14] [15]

PCI/VGA Palette Snoop [Disabled]

Some non-standard VGA cards, like graphics accelerators or MPEG video cards, may not show colors properly. Setting this field to [Enabled] corrects this problem. If you are using standard VGA cards, leave this field to the default setting [Disabled]. Configuration options: [Disabled] [Enabled]

PCI Latency Timer [32]

Leave on default setting for best performance vs. stability.

Onboard SCSI BIOS [Auto]

[Auto] allows the motherboard BIOS to detect whether you have a Adaptec SCSI controller. If the SCSI controller is detected, the SCSI BIOS will be enabled. If no SCSI controller is detected, the onboard SCSI BIOS will be disabled.

Setting to [Disabled] deactivates the onboard SCSI BIOS so that the BIOS on an add-on SCSI card can be used. If your SCSI card does not have a BIOS, the SCSI card will not function. Configuration options: [Auto] [Disabled]



The Onboard SCSI BIOS option may appear only on PU-DLS BIOS setup.

Primary VGA BIOS First [PCI VGA Card]

This field allows you to select the primary graphics card. Configuration options: [PCI VGA Card] [AGP VGA Card]

USB 1.1 Controllers [3 Controllers]

This field allows you to select the number of USB 1.1 controllers that you wish to activate. Configuration options: [Disabled] [3 Controllers]

ONB Intel 82544 LAN Boot ROM [Disabled]

ONB Intel 82540 LAN Boot ROM [Disabled]

When set to [Enabled], these fields allow the system to boot from the network using the onboard LAN controller boot ROM. Configuration options: [Disabled] [Enabled]

4.4.3.1 PCI IRQ Resource Exclusion

| AwardBIOS Setup Utility | | | |
|----------------------------|----------|----------|--|
| Advanced | | | |
| PCI IRQ Resource Exclusion | | | Item Specific Help |
| IRQ 3 | Reserved | [No/ICU] | Select [Yes] if this IRQ is required by a legacy ISA card and you are not using ICU; otherwise, select [No/ICU]. |
| IRQ 4 | Reserved | [No/ICU] | |
| IRQ 5 | Reserved | [No/ICU] | |
| IRQ 7 | Reserved | [No/ICU] | |
| IRQ 9 | Reserved | [No/ICU] | |
| IRQ 10 | Reserved | [No/ICU] | |
| IRQ 11 | Reserved | [No/ICU] | |
| IRQ 12 | Reserved | [No/ICU] | |
| IRQ 14 | Reserved | [No/ICU] | |
| IRQ 15 | Reserved | [No/ICU] | |

F1 Help ↑↓ Select Item -/+ Change Values F5 Setup Defaults
ESC Exit ↔ Select Menu Enter Select ▶ Sub-Menu F10 Save and Exit

IRQ XX Reserved [No/ICU]

These fields indicate whether or not the displayed IRQ for each field is being used by a legacy (non-PnP) ISA card. The setting [No/ICU] for an IRQ field indicates that you are using the ISA Configuration Utility (ICU), and that this particular IRQ is NOT required by a legacy ISA card. Set the IRQ field to [Yes] if you install a legacy ISA card that requires a unique IRQ and you are NOT using ICU. Configuration options: [No/ICU] [Yes]

4.5 Power Menu

The Power menu allows you to reduce power consumption. This feature turns off the video display and shuts down the hard disk after a period of inactivity.

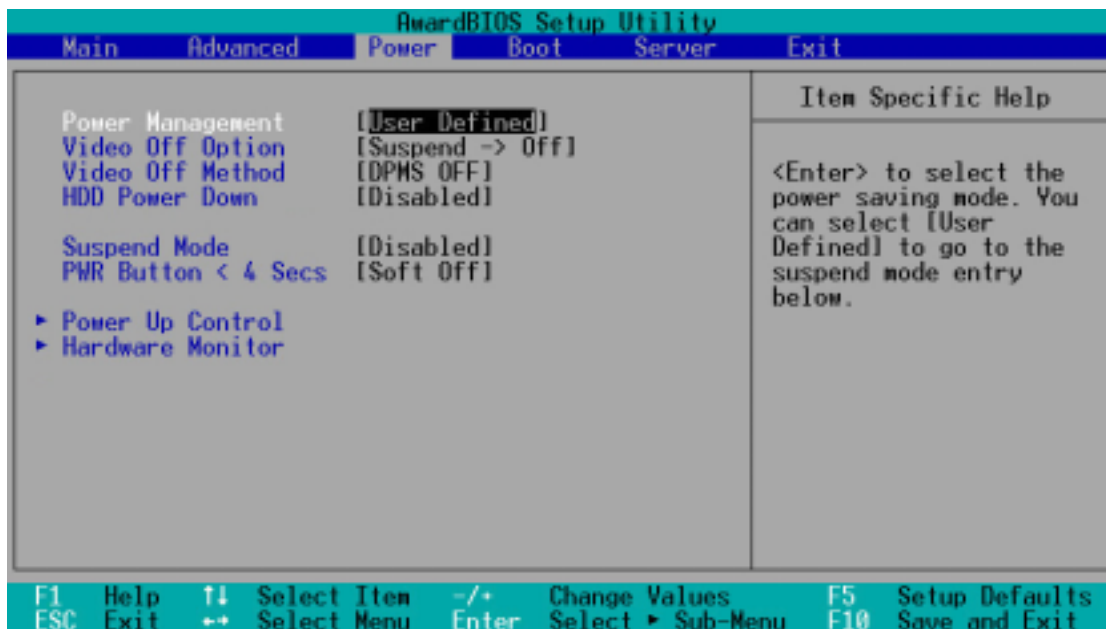

Power Management [User Defined]

This field allows you to activate or deactivate the automatic power saving features. When set to [Disabled], the power management features do not function regardless of the other settings on this menu. The [User Defined] option allows you to set the period of inactivity before the system enters suspend mode. Refer to “Suspend Mode” item.

When set to [Max Saving], system power is conserved to its greatest amount. This setting automatically puts the system into suspend mode after a brief period of system inactivity. [Min Saving] allows the least power saving as the system enters suspend mode only after a long period of inactivity. Configuration options: [User Defined] [Disabled] [Min Saving] [Max Saving]



You should install the Advanced Power Management (APM) utility to keep the system time updated even when the computer enters suspend mode. In Windows 3.x and Windows 95, you need to install Windows with the APM feature. In Windows 98 or later, APM is automatically installed as indicated by a battery and power cord icon labeled “Power Management” in the Control Panel. Select the item “Advanced” in the Power Management Properties dialog box.

Video Off Option [Suspend -> Off]

This field determines when to activate the video off feature for monitor power management. Configuration options: [Always On] [Suspend -> Off]

Video Off Method [DPMS OFF]

This field defines the video off features. The Display Power Management System (DPMS) feature allows the BIOS to control the video display card if it supports the DPMS feature. [Blank Screen] only blanks the screen. Use this for monitors without power management or “green” features.



Even if installed, your screen saver does not display when you select [Blank Screen] for the above field.

[V/H SYNC+Blank] blanks the screen and turns off vertical and horizontal scanning. Configuration options: [Blank Screen] [V/H SYNC+Blank] [DPMS Standby] [DPMS Suspend] [DPMS OFF] [DPMS Reduce ON]

HDD Power Down [Disabled]

Shuts down any IDE hard disk drives in the system after a period of inactivity as set in this user-configurable field. This feature does not affect SCSI hard drives attached on a PU-DLS motherboard. Configuration options: [Disabled] [1 Min] [2 Min] [3 Min]...[15 Min]

Suspend Mode [Disabled]

Sets the time period before the system goes into suspend mode. Configuration options: [Disabled] [1~2 Min] [2~3 Min] [4~5 min] [8~9 Min] [20 Min] [30 Min] [40 Min] [1 Hour]

PWR Button < 4 Secs [Soft Off]

When set to [Soft off], the ATX switch can be used as a normal system power-off button when pressed for less than 4 seconds. [Suspend] allows the button to have a dual function where pressing less than 4 seconds puts the system in sleep mode. Regardless of the setting, holding the ATX switch for more than 4 seconds powers off the system. Configuration options: [Soft off] [Suspend]

4.5.1 Power Up Control

| AwardBIOS Setup Utility | |
|--|---|
| Power | |
| Power Up Control | Item Specific Help |
| AC Power Loss Restart [Disabled] | <Enter> to select whether or not to restart the system after AC power loss. |
| Wake/Power Up On Ext. Modem [Disabled] | |
| Power Up On PCI Device [Disabled] | |
| Power Up By PS/2 Keyboard [Disabled] | |
| Power On By PS/2 Mouse [Disabled] | |
| Automatic Power Up [Disabled] | |

F1 Help ↑ Select Item -/+ Change Values F5 Setup Defaults
ESC Exit ↔ Select Menu Enter Select ▶ Sub-Menu F10 Save and Exit

AC PWR Loss Restart [Disabled]

This allows you to set whether or not to reboot the system after power interruptions. [Disabled] leaves your system off. [Previous State] sets the system back to the state it was before the power interruption.

Configuration options: [Disabled] [Previous State]

Wake/Power Up On Ext. Modem [Disabled]

This allows either settings of [Enabled] or [Disabled] for powering up the computer when the external modem receives a call while the computer is in Soft-off mode. Configuration options: [Disabled] [Enabled]



The computer cannot receive or transmit data until the computer and applications are fully running. Thus, connection cannot be made on the first try. Turning an external modem off and then back on while the computer is off causes an initialization string that turns the system power on.

Power Up On PCI Device [Disabled]

When set to [Enabled], this parameter allows you to turn on the system through a PCI LAN or modem card. This feature requires an ATX power supply that provides at least 1A on the +5VSB lead. Configuration options: [Disabled] [Enabled]

Power On By PS/2 Keyboard [Disabled]

This parameter allows you to any key on the keyboard to turn on the system. This feature requires an ATX power supply that provides at least 1A on the +5VSB lead. You must also set jumper J14 to enabled (pins 2-3) to activate the keyboard wake-up feature. Configuration options: [Disabled] [Enabled]

Power On By PS/2 Mouse [Disabled]

When set to [Enabled], this parameter allows you to use the PS/2 mouse to turn on the system. This feature requires an ATX power supply that provides at least 1A on the +5VSB lead. Configuration options: [Disabled] [Enabled]

Automatic Power Up [Disabled]

This allows an unattended or automatic system power up. You may configure your system to power up at a certain time of the day by selecting [Everyday] or at a certain time and day by selecting [By Date]. Configuration options: [Disabled] [Everyday] [By Date]

4.5.2 Hardware Monitor

| AwardBIOS Setup Utility | | |
|--|---|--|
| Power | | |
| Hardware Monitor | Item Specific Help | |
| MB Temperature 30°C/86°F | <Enter> to switch between monitoring or ignoring. | |
| CPU0 Temperature 41°C/105.5°F | | |
| CPU1 Temperature 50°C/122.0°F | | |
| CPU0 Fan Speed 7500RPM | | |
| CPU1 Fan Speed 5273RPM | | |
| Chassis Fan1 Speed 7500RPM | | |
| Chassis Fan2 Speed 5273RPM | | |
| VCORE Voltage 1.50V | | |
| 3.3V Voltage 3.45V | | |
| 5V Voltage 4.91V | | |
| 12V Voltage 12.09V | | |
| F1 Help ↑↓ Select Item -/+ Change Values F5 Setup Defaults | | |
| ESC Exit ↔ Select Menu Enter Select ▶ Sub-Menu F10 Save and Exit | | |

MB Temperature [xxxC/xxxF]

CPU0 Temperature [xxxC/xxxF]

CPU1 Temperature [xxxC/xxxF]

The onboard hardware monitor is able to detect the MB (motherboard) and CPU temperatures. Set to [Ignore] only if necessary.

CPU0 Fan Speed [xxxxRPM]

CPU1 Fan Speed [xxxxRPM]

Chassis Fan1 Speed [xxxxRPM]

Chassis Fan2 Speed [xxxxRPM]

The onboard hardware monitor is able to detect the CPU fan speeds in rotations per minute (RPM). The presence of the fans is automatically detected.

VCORE Voltage, 3.3V Voltage, 5V Voltage, 12V Voltage

The onboard hardware monitor is able to detect the voltage output by the onboard voltage regulators.



If any of the monitored items is out of range, the following error message appears: "Hardware Monitor found an error. Enter Power setup menu for details". You will then be prompted to "Press F1 to continue or DEL to enter SETUP".

4.6 Boot Menu

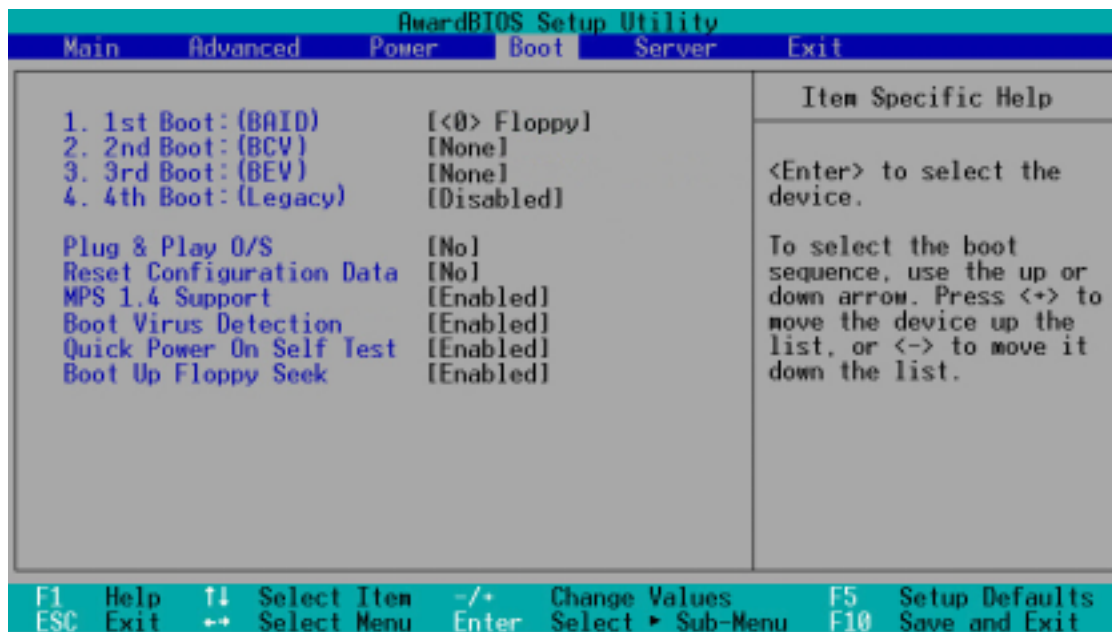

The motherboard BIOS supports the BIOS Boot Specification (BBS) version 1.01. BBS is an intelligent mechanism that provides flexible ways to set boot sequence for Initial Program Load (IPL) devices such as CD-ROMs, network remote boot ROM, and SCSI or RAID controllers on PnP cards.

The IPL devices are classified into three categories:

1. BIOS Aware IPL Devices (BAID)
2. PnP devices, includes Boot Connection Vector (BCV) and Bootstrap Entry Vector (BEV) devices
3. Legacy devices

1st Boot : (BAID) [<0> Floppy]

This field allows you to select a BIOS Aware IPL Devices (BAID) to boot from. A BAID is any device that can boot on an operating system but requires a specific BIOS code for support. Bootable FDDs, ATA HDD, ATAPI CD-ROM, ATA ZIP, and ATA MO drives are classified as BAID. The drives present in the system will appear as options for this field.

2nd Boot : (BCV) [None]

This field allows you to select a Boot Connection Vector (BCV) device to boot from. BCV devices include SCSI controllers or SCSI cards, RAID cards, and other devices on add-on cards with option ROM that hooks INT 13 to BIOS. The BCV devices present in the system will appear as options for this field. The field shows [None] if no BCV device is installed.



Boot Connection Vector devices are supported only on PU-DLS models.

3rd Boot : (BEV) [None]

This field allows you to select a Bootstrap Entry Vector (BEV) device to boot from. BEV devices include network controllers or cards. The BEV devices present in the system will appear as options for this field. For this motherboard, the following options are present onboard:

[<0> Intel Corporation IBA 4.0.22 Slo (LAN A)]

[<1> Intel Corporation IBA 4.0.22 Slo (LAN B)]

4th Boot : (Legacy) [Disabled]

This field reserves the boot sequence selection only to legacy devices including FDD, HDD, CD-ROM, SCSI, and LAN. This mode does not allow booting from a boot device on an add-on card or controller. If you wish to assign a device as a 1st Boot device for a specific application, you must set that legacy device at the 1st Boot sequence.

For this motherboard, the following options are present onboard:

[Disabled] [Floppy] [HDD] [CD-ROM] [LAN Option ROM]

[SCSI HD/CDROM] [USB FD] [Hook INT19]

Plug & Play O/S [No]

This field allows you to use a Plug-and-Play (PnP) operating system to configure the PCI bus slots instead of using the BIOS. When [Yes] is selected, interrupts may be reassigned by the OS. If you installed a non-PnP OS or if you want to prevent reassigning of interrupt settings, keep the default setting [No]. Configuration options: [No] [Yes]

Reset Configuration Data [No]

The Extended System Configuration Data (ESCD) contain information about non-PnP devices. It also holds the complete record of how the system was configured the last time it was booted. Select [Yes] if you want to clear these data during the Power-On-Self-Test (POST). Configuration options: [No] [Yes]

MPS 1.4 Support [Enabled]

This field allows you to enable or disable the MultiProcessor Specification 1.4 support. Configuration options: [Disabled] [Enabled]

Boot Virus Detection [Enabled]

This field allows you to set boot virus detection, ensuring a virus-free boot sector. The system halts and displays a warning message when it detects a virus. If this occurs, you can either allow the operation to continue or use a virus-free bootable floppy disk to restart and investigate your system.

Configuration options: [Disabled] [Enabled]

Quick Power On Self Test [Enabled]

This field speeds up the Power-On-Self Test (POST) routine by skipping retesting a second, third, and fourth time. Configuration options: [Disabled] [Enabled]

Boot Up Floppy Seek [Enabled]

When enabled, the BIOS will seek the floppy disk drive to determine whether the drive has 40 or 80 tracks. Configuration options: [Disabled] [Enabled]

4.7 Server Menu

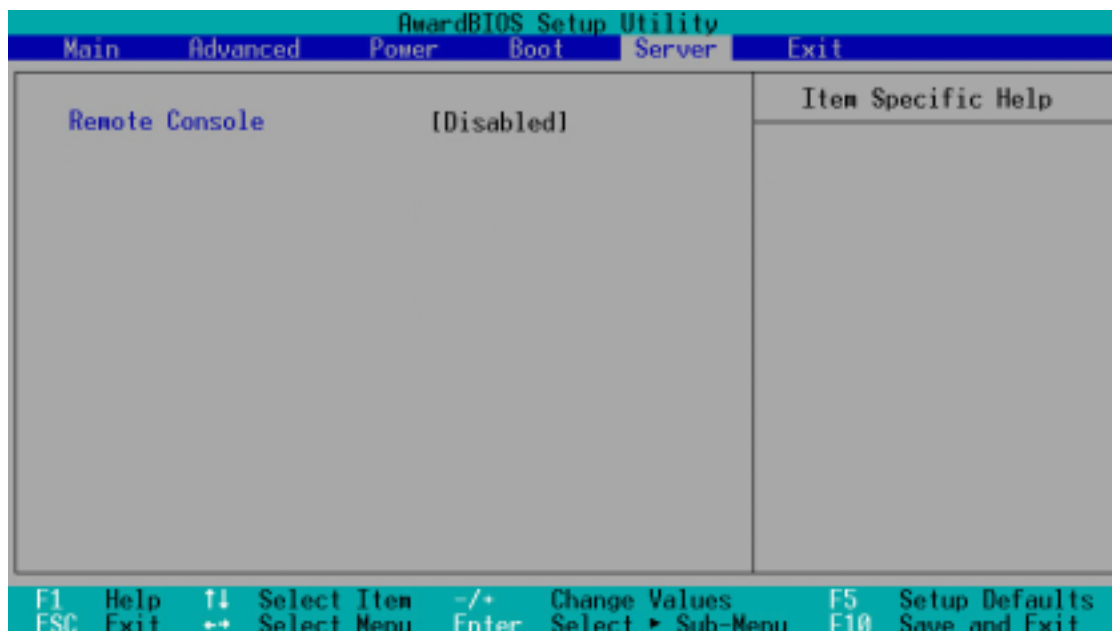

Remote Console [Disabled]

This field allows the text mode VGA display to be sent out to VT100 terminal through COM1. This function is effective at BIOS POST and DOS environment. Configuration options: [Disabled] [Enabled] [POST Only]

4.8 Exit Menu

When you have made all of your selections from the various menus in the Setup program, save your changes and exit Setup. Select Exit from the menu bar to display the following menu.

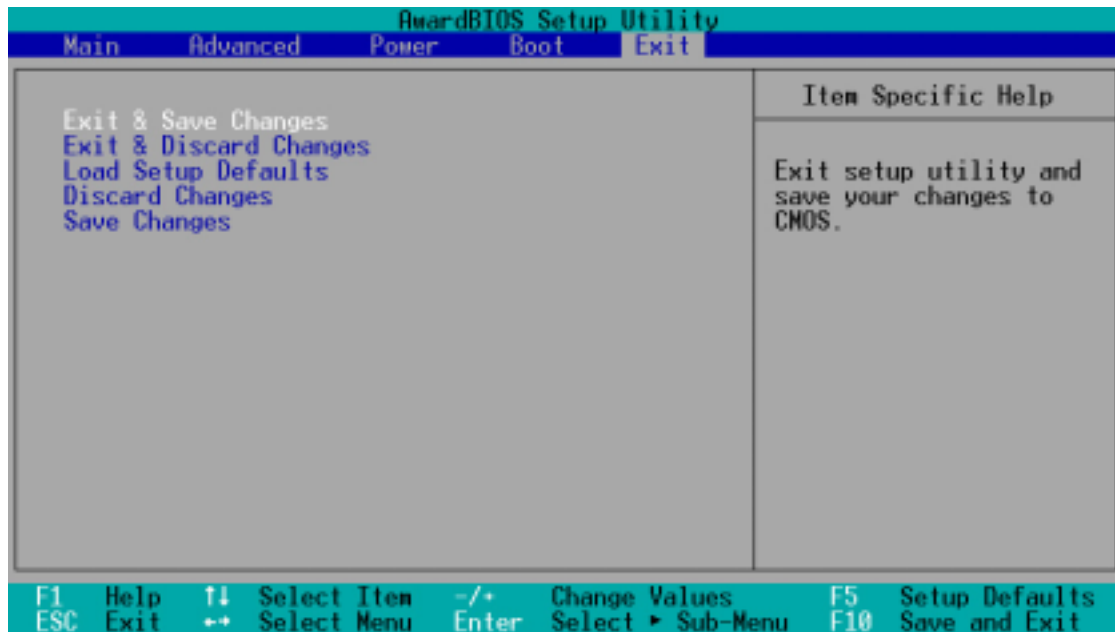

Pressing <Esc> does not immediately exit this menu. Select one of the options from this menu or <F10> from the legend bar to exit.

Exit & Save Changes

Once you are finished making your selections, choose this option from the Exit menu to ensure the values you selected are saved to the CMOS RAM. The CMOS RAM is sustained by an onboard backup battery and stays on even when the PC is turned off. When you select this option, a confirmation window appears. Select [Yes] to save changes and exit.



If you attempt to exit the Setup program without saving your changes, the program prompts you with a message asking if you want to save your changes before exiting. Pressing <Enter> saves the changes while exiting.

Exit & Discard Changes

Select this option only if you do not want to save the changes that you made to the Setup program. If you made changes to fields other than system date, system time, and password, the BIOS asks for a confirmation before exiting.

Load Setup Defaults

This option allows you to load the default values for each of the parameters on the Setup menus. When you select this option or if you press <F5>, a confirmation window appears. Select [Yes] to load default values. Select Exit Saving Changes or make other changes before saving the values to the non-volatile RAM.

Discard Changes

This option allows you to discard the selections you made and restore the previously saved values. After selecting this option, a confirmation appears. Select [Yes] to discard any changes and load the previously saved values.

Save Changes

This option saves your selections without exiting the Setup program. You can then return to other menus and make further changes. After you select this option, a confirmation window appears. Select [Yes] to save any changes to the non-volatile RAM.

Chapter 5

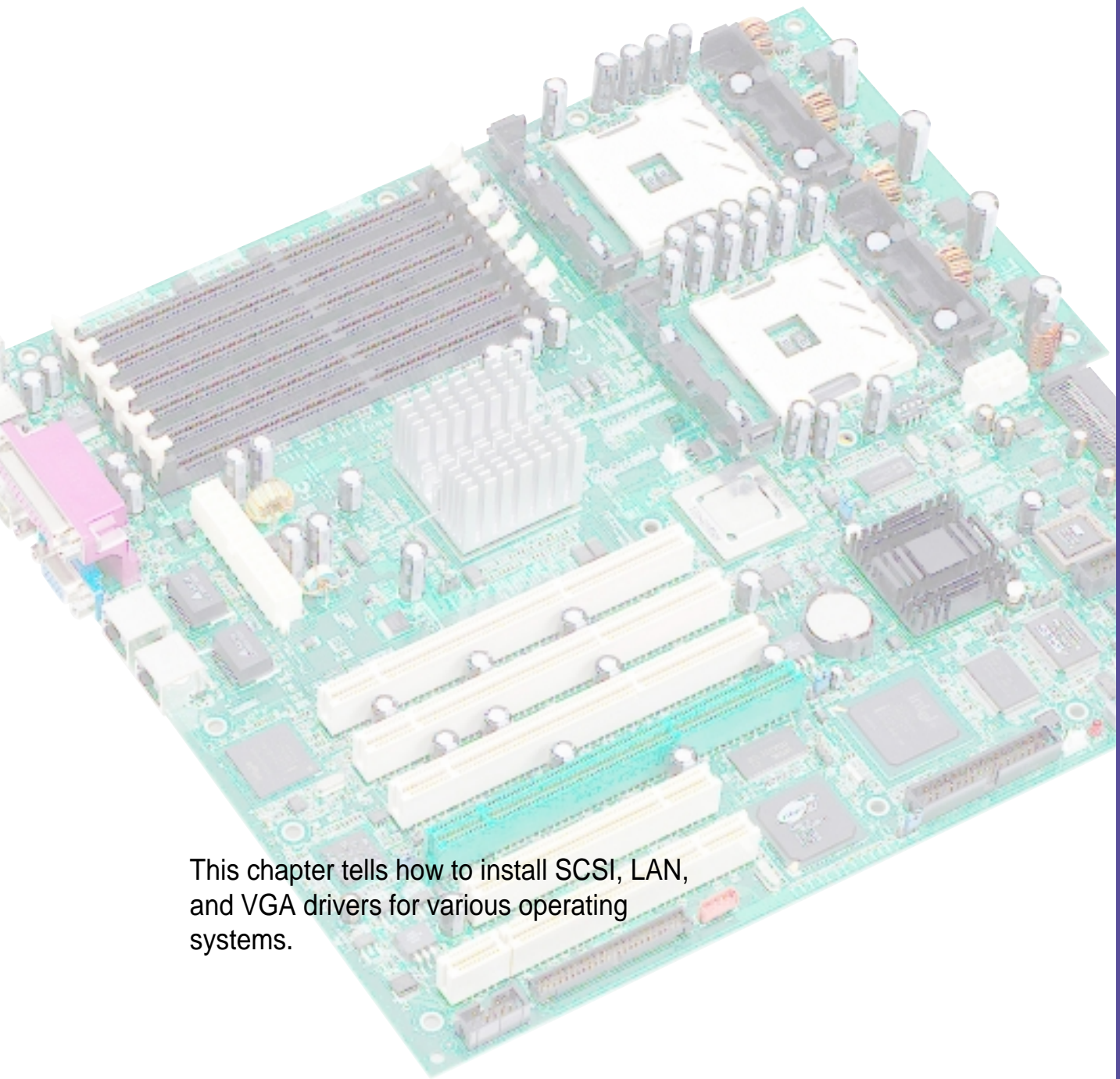

This chapter tells how to install SCSI, LAN, and VGA drivers for various operating systems.

Driver installation

Chapter summary

| | | |
|------------|--|-------------|
| 5.1 | Support CD contents | 5-1 |
| 5.2 | Microsoft Windows NT Server 4.0 | 5-3 |
| 5.3 | Microsoft Windows 2000 Server | 5-12 |
| 5.4 | Microsoft Windows XP Professional | 5-22 |
| 5.5 | Novell NetWare Server | 5-31 |
| 5.6 | SCO Open Server 5.0.6 | 5-39 |
| 5.7 | Linux RedHat 8.0 | 5-41 |

5.1 Support CD contents

The support CD that came with the motherboard contains useful software and several utility drivers that enhance the motherboard features.

To begin using the support CD, simply insert the CD into your CD-ROM drive. The CD automatically displays the welcome screen and the installation menus if Autorun is enabled in your computer.



If **Autorun** is NOT enabled in your computer, browse the contents of the support CD to locate the file **ASSETUP.EXE** from the BIN folder. Double-click the **ASSETUP.EXE** to run the CD.

5.1.1 Drivers

This screen displays the drivers available for the onboard devices. Follow the installation wizards or find additional instructions as text files in each of the driver folders.

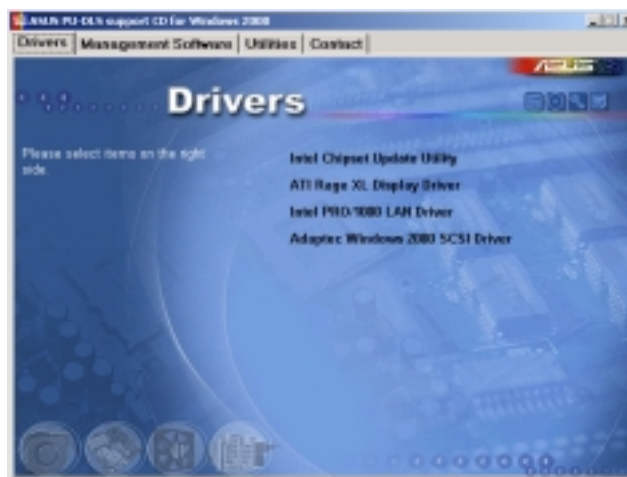

The Adaptec SCSI Driver appears only on PU-DLS models.

5.1.2 Management Software

This screen displays the ASUS proprietary server management software.



5.1.3 Utilities

This screen displays the available system utilities that you can install.

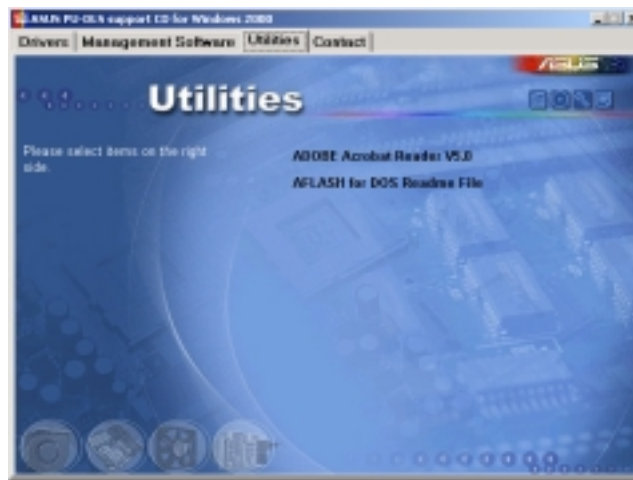

5.1.4 Contact

This screen displays the ASUS worldwide contact information.



5.2 Microsoft® Windows® NT Server 4.0

5.2.1 Adaptec® SCSI driver installation

Windows NT 4.0 does not have the driver for the SCSI controllers. You must load the driver manually prior to Windows NT 4.0 installation.



The Adaptec® SCSI Driver appears only on PU-DLS models.

A. Preparing an Adaptec Ultra320 FMS driver disk

A1. Using the Drivers menu in the support CD

1. Insert a blank formatted high density floppy disk into the floppy drive.
2. Place the support CD into the CD-ROM drive. The Drivers menu appears displaying the available drivers.
3. Click on the item “**Adaptec Windows NT 4.0 SCSI Driver.**” The ASUS File Image Extractor window appears.
4. Type the required information, then click on **Extract**.
5. Follow the succeeding screen instructions to complete the process.

A2. Using the driver self-extracting file

1. Insert a blank formatted high-density floppy disk into the floppy drive.
2. Place the support CD into the CD-ROM drive.
3. Click on the CD icon near the top right corner of the menu to display the folders and sub-folders in the support CD.
4. Double-click on the **ntsetup.exe** file under the folder path:
`\\drivers\\adaptec\\7902\\winnt40\\`
5. Follow the succeeding screen instructions to complete the process.

A3. Manually

1. Insert a blank formatted high-density floppy disk into the floppy drive.
2. Place the support CD into the CD-ROM drive.
3. Click on the CD icon near the top right corner of the menu to display the folders and sub-folders in the support CD.

4. Copy the entire **winnt40 folder** and the **txtsetup.oem** file from the support CD into the root directory of the floppy disk. These items are in the following folder path:

`\drivers\adaptec\7902\`

B. Installing Windows NT 4.0 with an Ultra320 SCSI Controller

Follow these steps to install Windows NT 4.0 for the first time with an Ultra320 SCSI controller.

1. Start your system with the Windows NT 4.0 Boot disk in the floppy disk drive or the Windows NT 4.0 Boot CD-ROM in the CD-ROM drive. NOTE: If there is DOS installed and you are trying to install Windows NT 4.0, then it may also be necessary to edit the config.sys file to include command lines for your CD-ROM drive. See the system documentation for more information.
2. When the following message appears onscreen, press the F6 key. "Setup is inspecting your computer system's hardware."
If you are installing from CD-ROM, skip to Step 4.

If you are installing from floppy disk, continue to Step 3.
3. For Windows NT 4.0 Boot disk installation only: When prompted, insert disk #2 in your floppy disk drive. After a few moments you will see a blue screen.
4. Press S to specify an additional device.
5. Press Enter to select Other; insert the Adaptec Ultra320 FMS driver disk in your floppy disk drive and press Enter.
6. The screen displays the adapter drivers supported on the disk. Select Adaptec Ultra320 SCSI Cards (WinNT 4.0) and press Enter.
7. If you want to add other drivers, press S and repeat Step 5 for each additional adapter and insert the appropriate disk provided by the hardware manufacturer.
8. Press Enter to continue with the Windows NT 4.0 operating system setup.
9. Follow the instructions onscreen and in the Windows NT 4.0 documentation to complete the installation.

C. Installing the Adaptec Ultra320 driver with existing Windows NT 4.0

1. Start Windows NT 4.0.
2. Click the Start button on the Windows NT 4.0 task bar, then point to Settings.
3. Click the Control Panel.
4. Double-click the SCSI Adapters icon.
5. Click the Drivers tab, then click the Add button.
6. In the Install Driver window, click the Have Disk button.
7. Insert the Adaptec Ultra320 FMS driver disk in your disk drive and press Enter. Enter the following path to the installation files and then click OK.
`\winnt40`
8. In the Install Driver window, select the Adaptec Ultra320 driver from the list. Click OK.
9. You must restart your computer for the changes to take effect. Click Yes to restart your computer.

D. Changing Boot Controllers in Windows NT 4.0

1. With the existing controller still installed, install the Ultra320 controller into your system. Do not attach any devices to it at this time.
2. Start Windows NT 4.0 and install the driver from the Adaptec Ultra320 driver disk.
3. Shut down Windows NT 4.0 and turn off your system.
4. Switch the bootable hard drive from the old SCSI controller to the Ultra320 controller.
5. Power on your system.

5.2.2 Intel® 82544GC/82540EM LAN driver installation



It is recommended that you use the Intel 82544GC/82540EM LAN drivers from the support CD.

A. Preparing the Intel 82544GC/82540EM LAN driver disk



Prepare one blank formatted high density floppy disk before proceeding.

Follow these steps to install the LAN drivers from the support CD.

1. Insert the support CD into the CD-ROM drive.
2. On the screen that appears, select **Create Install Disk**.



3. The next screen allows you to select an operating system to install the driver. Select Windows Windows NT 4.0.
4. Select A:/ for the destination drive, then click on **Create Disk**. (See picture on the next page.)



5. Follow the succeeding installation instructions.
6. When done, the following screen appears. Click **Finish** to complete the installation.



B. New System Installation

1. When the **Installing Windows NT Networking** screen appears, press **Next** to display the following screen.

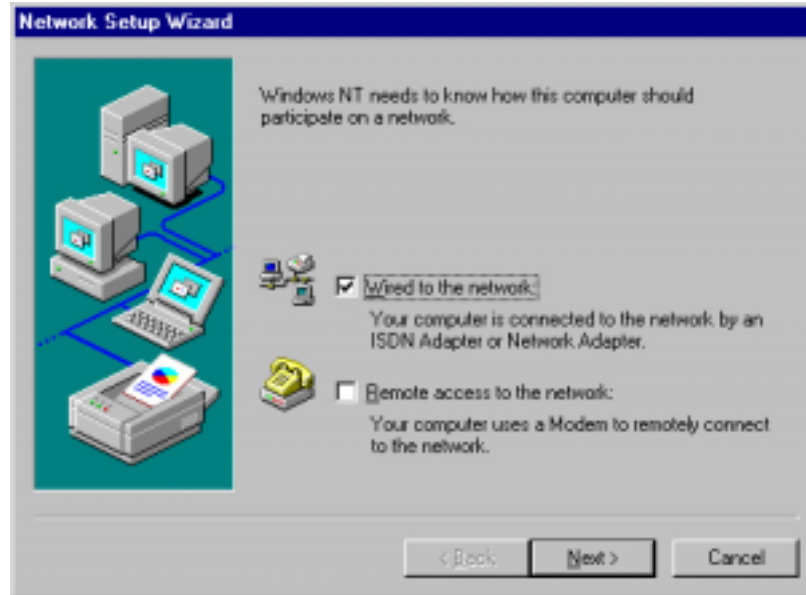

2. Check the **Wired to the Network** box, then click **Next**.
3. On the screen that appears, click the button **Select from list...** to display the following.

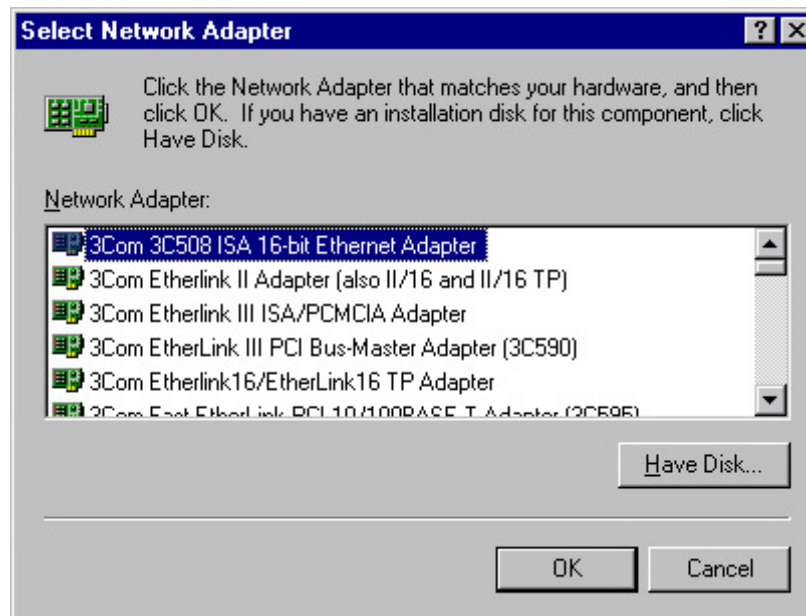

4. Insert the LAN driver disk that you created, then click **Have Disk...**
5. Type **A:** in the dialog box that appears, then click OK. The following screen lists the Intel LAN adapters that you can install.

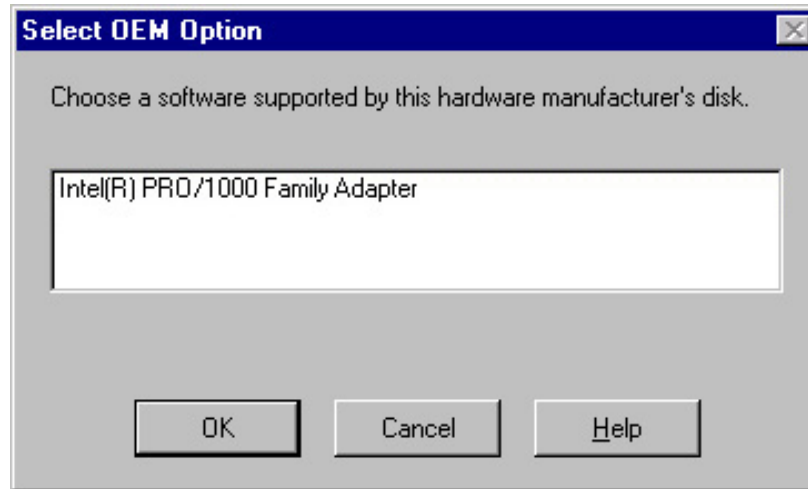

6. Select **Intel(R) PRO/1000 Family Adapter**, then click OK. Follow the succeeding screen instructions.
7. When done, the following screen appears showing the **Intel(R) PRO/1000 Family Adapter** in the list.

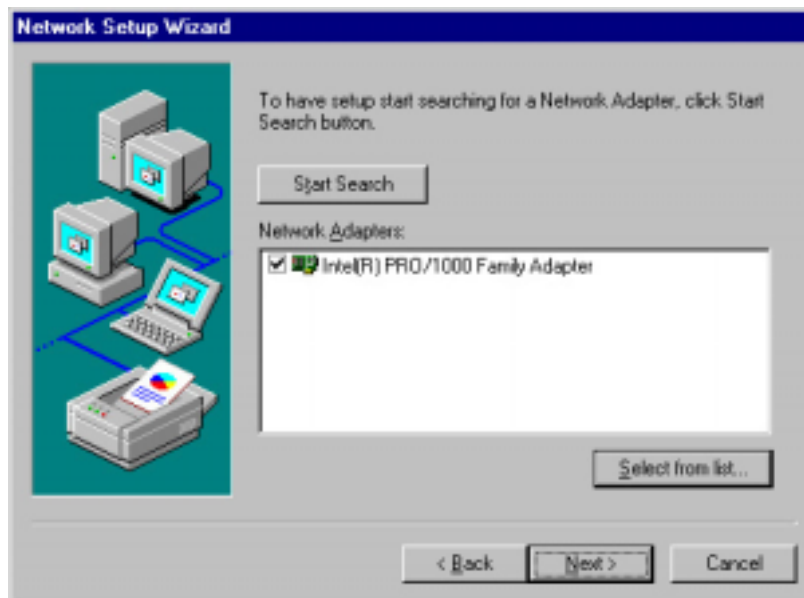

8. Click **Next** and follow any other screen instructions to complete the installation.

C. Existing System Installation

1. Double-click the **Network** icon in the Control Panel.
2. Select the **Adapter** tab, then click **Add**. A list of adapters appears.
4. Do not select an adapter from the list. Instead, insert the LAN driver disk that you created from the Support CD.

Refer to the section *“A. Preparing the Intel 82544GC/82540EM LAN Driver Disk”* if you have not yet created the LAN driver disk.

5. Follow steps 4 to 8 in section *“B. New System Installation”* to install the required LAN drivers.

5.2.3 ATI® Rage XL display driver installation

1. Insert the support CD into your CD-ROM drive.
2. If Autorun is enabled in your computer, the following screen appears. Click on **ATI Rage XL Display Driver** to install the driver.

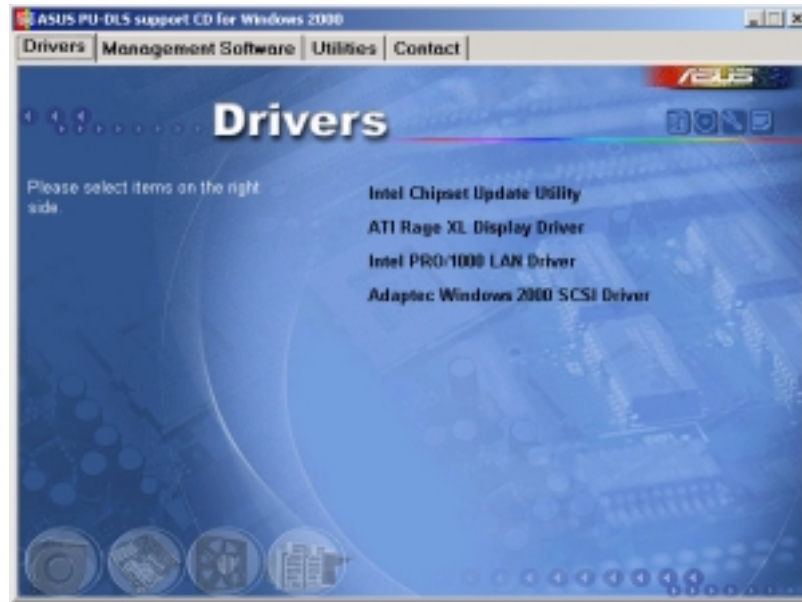

If Autorun is disabled, install the display driver from the following path:

\\Drivers\\Ati\\Nt40\\Setup.exe

3. Follow the screen instructions to complete the installation.

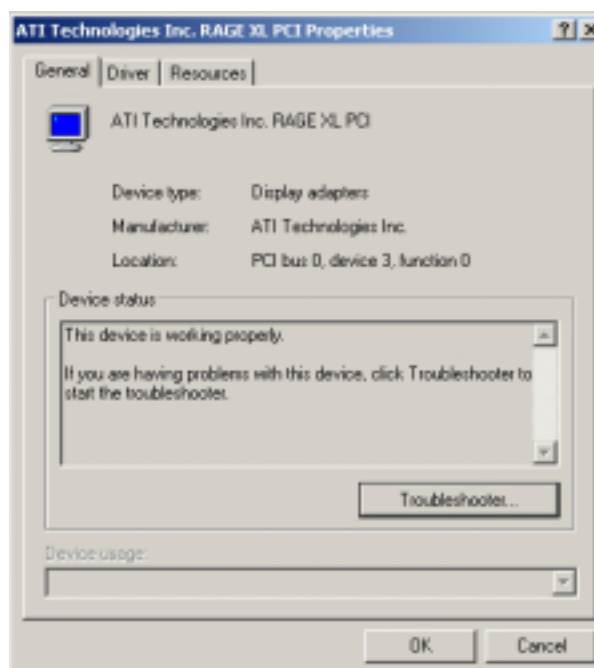

5.3 Microsoft® Windows® 2000 Server

5.3.1 Adaptec® SCSI driver installation

Windows 2000 does not have the driver for the SCSI controller. You must load the driver manually prior to Windows 2000 installation.



The Adaptec® SCSI Driver appears only on PU-DLS models.

A. Preparing an Adaptec Ultra320 FMS driver disk

A1. Using the Drivers menu in the support CD

1. Insert a blank formatted high density floppy disk into the floppy drive.
2. Place the support CD into the CD-ROM drive. The Drivers menu appears displaying the available drivers.
3. Click on the item “**Adaptec Windows 2000 SCSI Driver.**” The ASUS File Image Extractor window appears.
4. Type the required information, then click on **Extract**.
5. Follow the succeeding screen instructions to complete the process.

A2. Using the driver self-extracting file

1. Insert a blank formatted high-density floppy disk into the floppy drive.
2. Place the support CD into the CD-ROM drive.
3. Click on the CD icon near the top right corner of the menu to display the folders and sub-folders in the support CD.
4. Double-click on the **2ksetup.exe** file under the folder path:
`\drivers\adaptec\7902\win2000\`
5. Follow the succeeding screen instructions to complete the process.

A3. Manually

1. Insert a blank formatted high-density floppy disk into the floppy drive.
2. Place the support CD into the CD-ROM drive.
3. Click on the CD icon near the top right corner of the menu to display the folders and sub-folders in the support CD.
4. Copy the entire **win2000 folder** and the **txtsetup.oem** file from the support CD into the root directory of the floppy disk. These items are in the following folder path:

`\drivers\adaptec\7902\`

B. Installing Windows 2000 with an Ultra320 SCSI Controller

Follow these steps to install Windows 2000 for the first time with an Ultra320 SCSI controller.

1. Start your system with the Windows 2000 Boot CD-ROM in the CD-ROM drive. Note: When using a CD-ROM drive to install Windows 2000 from the bootable CD-ROM, make sure Bootable CD-ROM support is enabled. This is done through the System BIOS Setup Utility.
2. Press F6 when this message appears:
“Press F6 if you need to install third-party SCSI drivers”
3. When prompted, press "S" to supply the new driver.
4. Insert the Adaptec Ultra320 FMS driver disk when the setup prompts you to insert the manufacturer supplied disk into drive A, and press Enter.
5. The screen displays the adapter drivers supported on the disk. Select “Adaptec Ultra320 SCSI Cards (Win2000)” and continue with the rest of the Windows 2000 installation.
6. Your system will reboot once more to finish setting up Windows 2000.

C. Installing the Adaptec Ultra320 driver with existing Windows 2000

1. Start Windows 2000. Windows 2000 will automatically discover the new hardware and start the Found New Hardware Wizard to guide you through the device driver installation.
2. At the Welcome to the Found New Hardware Wizard window, select Next.
3. On the Install Hardware Device Drivers screen, select Display a list of the known drivers for this device, and click Next.
4. Select the Have Disk button. You will be prompted to insert the manufacturer supplied disk. Insert the Adaptec Ultra320 FMS driver disk in your disk drive and enter the following path, then click OK.
`\\win2000`
5. Select the Adaptec Ultra320 driver from the list, then click the Next button.

6. Click the Next button again to confirm the installation of the driver. You may be prompted with this warning message:
“The software you are about to install does not contain a Microsoft digital signature ...”
Ignore the warning and click Yes to continue the installation.
7. When the driver is copied on the hard drive, click Finish.
8. You will be prompted to restart the computer. Select Yes.

D. Updating the Adaptec Ultra320 driver under Windows 2000

Follow these instructions only if Windows 2000 is already installed.

1. Right-click on My Computer and choose Properties from the menu. Click on the Hardware tab and click on the Device Manager button.
2. Under SCSI and RAID controllers, click on the “+” sign (on the left) to display the current SCSI adapters installed. Right-click on the device that you wish to update, and select Properties.
3. Click on the Driver tab and click on the Update Driver... button to start the Upgrade Device Driver Wizard. Click Next.
4. Make sure the Search for a suitable driver for my device (recommended) option is selected, then click Next.
5. Make sure the only selection that is checked is Specify a location. Insert the Adaptec Ultra320 FMS driver disk into the disk drive and click Next.
6. At the Copy manufacturer’s files from text box, type the following, and click OK.
a:\win2000
7. Choose a driver from the Adaptec provider that best fits your adapter and click Next.
8. Windows 2000 may state that a Digital Signature was not found for this driver. Click Yes.
9. If you are asked to enter in the path for the driver, type
a:\win2000
10. Click Finish. You may be required to reboot your system at this point.

E. Changing Boot Controllers in Windows 2000

1. With the existing controller still installed, install the Ultra320 controller into your system. Do not attach any devices to it at this time.
2. Boot up the operating system. Install the driver for the Adaptec Ultra320 Adapter.
3. Shut down Windows 2000. Turn off your system if necessary.
4. Switch the bootable hard drive from the old SCSI controller to the Ultra320 controller and boot up your computer.

5.3.2 Intel® 82544GC/82540EM LAN driver installation



It is recommended that you use the Intel 82544GC/82540EM LAN drivers from the support CD.

A. Preparing the Intel 82544GC/82540EM LAN driver disk



Prepare one blank formatted high density floppy disk before proceeding.

Follow these steps to install the LAN drivers from the support CD.

1. Insert the support CD into the CD-ROM drive.
2. On the screen that appears, select **Create Install Disk**.



3. The next screen allows you to select an operating system to install the driver. Select Windows 2000.
4. Select A:\ for the destination drive, then click on **Create Disk**. (See picture on the next page.)



5. Follow the succeeding installation instructions.
6. When done, the following screen appears. Click **Finish** to complete the installation.



B. Update Driver on an Existing System Installation

You may update the LAN driver directly from the support CD.

1. Insert the support CD into the CD-ROM drive. On the screen that appears, click on **Intel PRO/1000 LAN Driver**, then on the item **Install Base Driver Only**.
2. Follow the screen instructions to complete the driver update.



When done, your Computer Management window shows the installed LAN adapters.

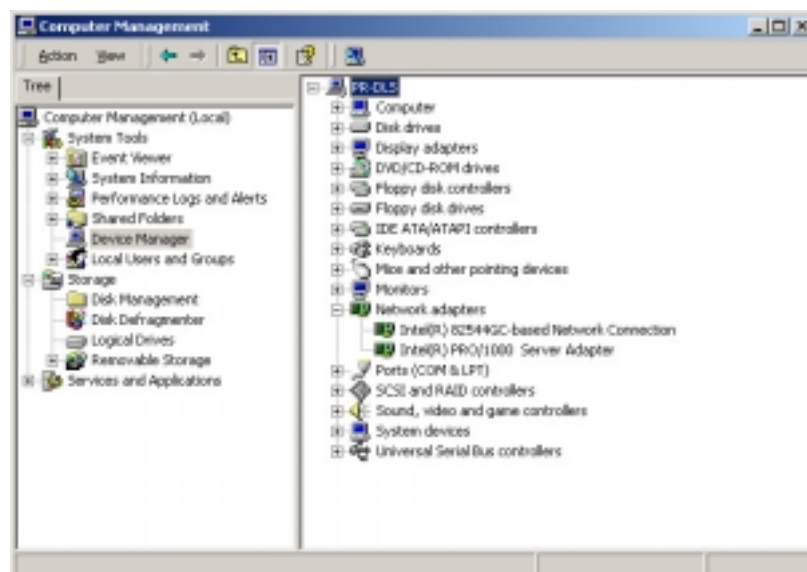

3. Highlight the **Intel(R) 82544GC-based Network Connection**, click the right mouse button, and select **Properties** to display the following.

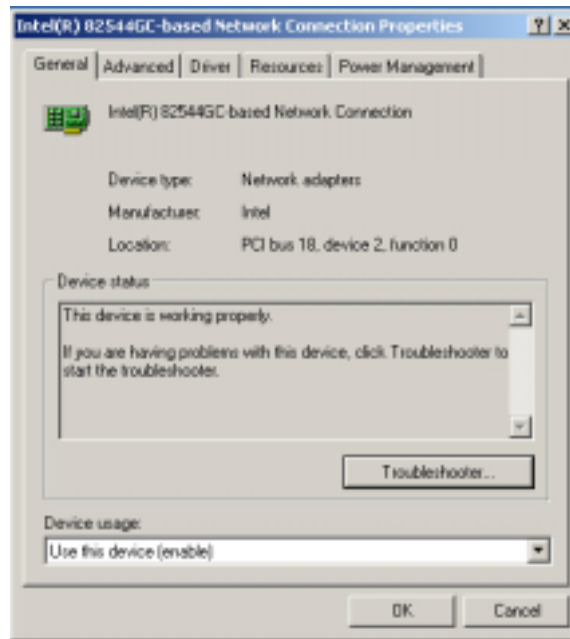

4. Highlight the **Intel(R) PRO-1000 Server Adapter**, click the right mouse button, and select **Properties** to display the following.



C. Updating the LAN driver using the LAN driver disk

You may also update the LAN drivers from the LAN Driver Disk if you created one in section “A. Preparing the Intel 82544GC/82540EM LAN Driver Disk.”

Follow these steps to update from the LAN driver disk.

1. Boot Windows 2000 system and log on as Administrator.
2. Click on the **Start** button. Select **Settings**, then **Control Panel**.
3. Double-click the **System** icon in the Control Panel. Select the **Hardware** tab to display the following screen.
4. Click on **Device Manager**, then on **Other Devices**.

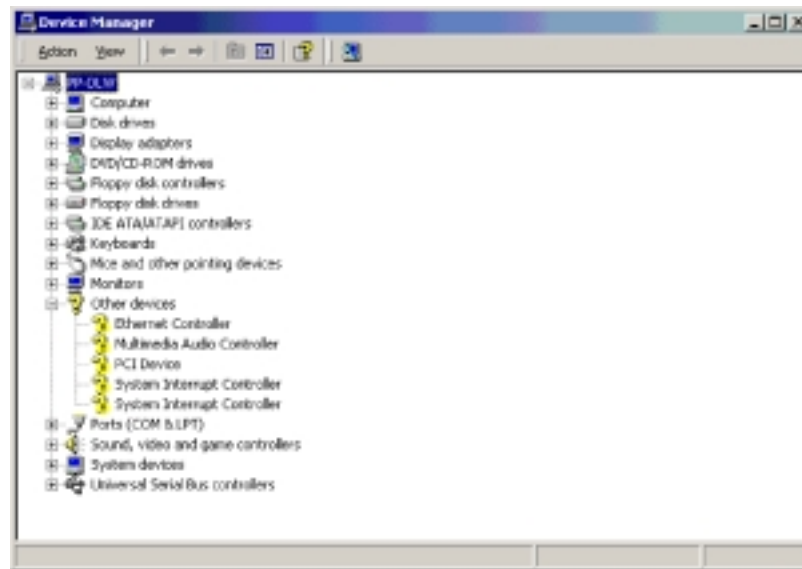

5. Highlight **Ethernet Controller**, then click the right mouse button and select **Properties**.
6. Select the **Driver** tab and click on **Update Drivers**.
7. Click **Next**. Select **Display a list of the known drivers for this device ...**
8. Select **Network adapters** under Hardware Type, and click **Next**.
9. Click **Have Disk...**, then insert the LAN driver disk.
10. Follow the succeeding instructions to complete the installation.

5.3.3 ATI® Rage XL Display Driver Installation

Windows 2000 system can automatically recognize the ATI RAGE XL PCI driver during system installation. You do not need to load any driver for supporting the onboard ATI RAGE XL graphics controller chipset.

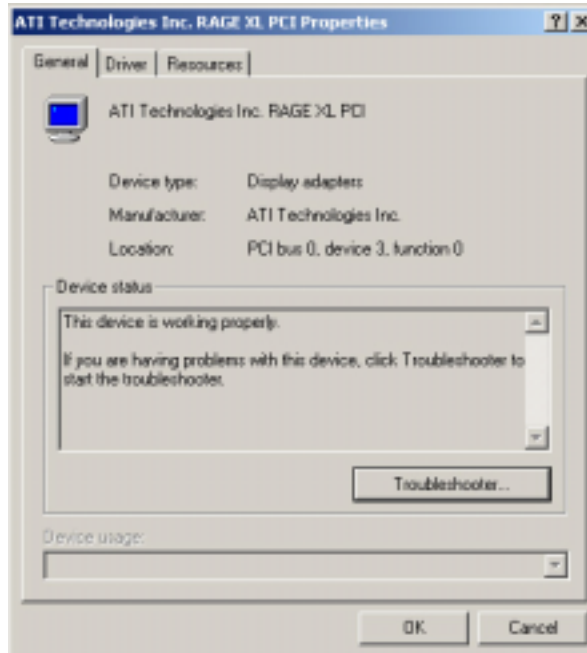

5.3.4 Enabling ATA100 Feature in Windows® 2000

To enable the ATA100 feature under Windows 2000, you need to upgrade to Windows 2000 Service Pack 2.

5.4 Microsoft® Windows® XP Professional

5.4.1 Adaptec® SCSI driver installation

Windows XP does not have the driver for the SCSI controller. You must load the driver manually prior to Windows XP installation.



The Adaptec® SCSI Driver appears only on PU-DLS models.

A. Preparing an Adaptec Ultra320 FMS driver disk

A1. Using the Drivers menu in the support CD

1. Insert a blank formatted high density floppy disk into the floppy drive.
2. Place the support CD into the CD-ROM drive. The Drivers menu appears displaying the available drivers.
3. Click on the item “**Adaptec Windows XP SCSI Driver.**” The ASUS File Image Extractor window appears.
4. Type the required information, then click on **Extract.**
5. Follow the succeeding screen instructions to complete the process.

A2. Using the driver self-extracting file

1. Insert a blank formatted high-density floppy disk into the floppy drive.
2. Place the support CD into the CD-ROM drive.
3. Click on the CD icon near the top right corner of the menu to display the folders and sub-folders in the support CD.
4. Double-click on the **xpsetup.exe** file under the folder path:
`\drivers\adaptec\7902\winxp\`
5. Follow the succeeding screen instructions to complete the process.

A3. Manually

1. Insert a blank formatted high-density floppy disk into the floppy drive.
2. Place the support CD into the CD-ROM drive.
3. Click on the CD icon near the top right corner of the menu to display the folders and sub-folders in the support CD.
4. Copy the entire **Winxp folder** and the **txtsetup.oem** file from the support CD into the root directory of the floppy disk. These items are in the following folder path:

`\drivers\adaptec\7902\`

B. Installing Windows XP (32-bit) with an Ultra320 SCSI Controller

Follow these steps to install Windows XP (32-bit) for the first time with an Ultra320 SCSI controller.

1. Start your system with the Windows XP Boot CD-ROM in the CD-ROM drive. NOTE: When using a CD-ROM drive to install Windows XP from the bootable CD-ROM, make sure Bootable CD-ROM support is enabled. This is done through the System BIOS Setup Utility.
2. Press F6 when this message appears:
“Press F6 if you need to install third-party SCSI drivers”
3. When prompted, press “S” to supply the new driver.
4. Insert the Adaptec Ultra320 FMS driver disk when the setup prompts you to insert the manufacturer supplied disk into drive A, and then continue.
5. The screen displays the adapter drivers supported on the disk. Select Adaptec Ultra320 SCSI Cards (WinXP IA32) and press Enter. Continue with the rest of the Windows installation.
6. Your system will reboot once more to finish setting up the operating system.

C. Installing Windows XP (64-bit) with an Ultra320 SCSI Controller

Follow these steps to install Windows XP (64-bit) for the first time with an Ultra320 SCSI controller.



You will need to modify the Adaptec Ultra320 FMS driver disk in order to properly install Windows XP 64-bit Edition.

1. On the disk, rename the TXTSETUP.OEM on the root directory to something like TXTSETUP.I32, and copy the TXTSETUP.OEM file from the \WINXP64\ directory to the root directory. NOTE: If you want to use this disk for installation of Windows XP (32-bit) in the future, the previous TXTSETUP.OEM file will need to be restored.
2. Start your system with the Windows XP Boot CD-ROM in the CD-ROM drive.

3. Press F6 when this message appears:
“Press F6 if you need to install third-party SCSI drivers”
4. Insert the Adaptec Ultra320 FMS driver disk when the setup prompts you to insert the manufacturer supplied disk into drive A, and then continue.
5. The screen displays the adapter drivers supported on the disk. Select Adaptec Ultra320 SCSI Cards (WinXP IA64) and press Enter. Continue with the rest of the Windows installation.
6. Your system will reboot once more to finish setting up the operating system.

D. Updating the Adaptec Ultra320 driver under Windows XP

Follow these instructions only if Windows XP is already installed.

1. Click the Start button on the Windows XP task bar, and point to Control Panel.
2. Click the Control Panel. If you are in Category View, click on Performance and Maintenance.
3. Click on System; click on the Hardware tab and click on the Device Manager button.
4. Under SCSI and RAID controllers, click on the “+” sign (on the left) to display the current SCSI adapters installed. Right-click on the device you wish to update, then click Properties.
5. Click on the Driver tab and click on the Update Driver... button to start the Hardware Update Wizard.
6. Make sure the option Install from a list or specific location (Advanced) is selected and click Next.
7. Make sure the option Don't search. I will choose the driver to install. is selected, then click Next.
8. Click the Have Disk... button and insert the Adaptec Ultra320 FMS driver disk into the disk drive.
9. At the Copy manufacturer's files from text box, type the following then click OK.
a:\winxp (or a:\winxp64 for IA-64 system)
10. Click the Next.
11. Windows XP may state that the software “..... has not passed Windows Logo testing...” Click “Continue Anyway.”
12. Click Finish. You may be required to reboot your system at this point.

5.4.2 Intel® 82544GC/82540EM LAN Driver Installation



It is recommended that you use the Intel 82544GC/82540EM LAN drivers from the support CD.

A. Preparing the Intel 82544GC/82540EM LAN driver disk



Prepare one blank formatted high density floppy disk before proceeding.

Follow these steps to install the LAN drivers from the support CD.

1. Insert the support CD into the CD-ROM drive.
2. On the screen that appears, select **Create Install Disk**.



3. The next screen allows you to select an operating system to install the driver. Select Windows XP.
4. Select A:/ for the destination drive, then click on **Create Disk**. (See picture on the next page.)



5. Follow the succeeding installation instructions.
6. When done, the following screen appears. Click **Finish** to complete the installation.



B. Update Driver on an Existing System Installation

You may update the LAN driver directly from the support CD.

1. Insert the support CD into the CD-ROM drive. On the screen that appears, click on **Intel PRO/1000 LAN Driver**, then on the item **Install Base Driver Only**.
2. Follow the screen instructions to complete the driver update.



When done, your Computer Management window shows the installed LAN adapters.

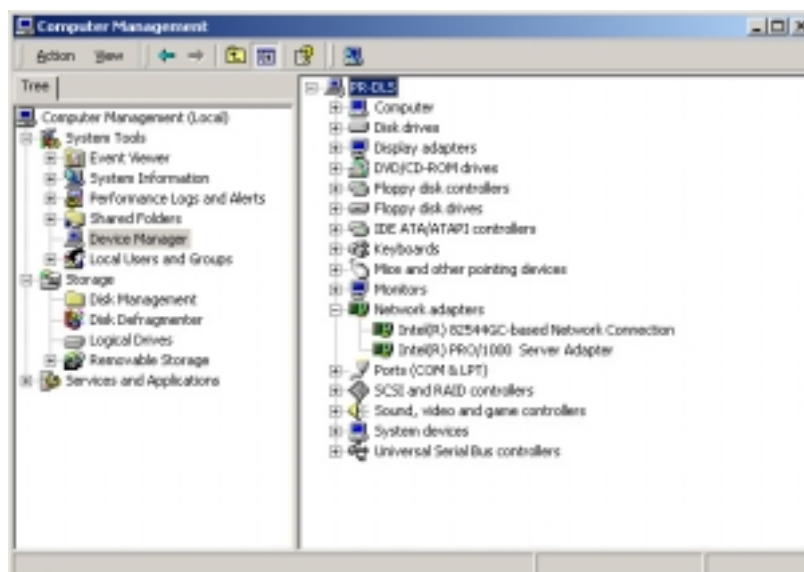

3. Highlight the **Intel(R) 8254GC-based Network Connection**, click the right mouse button, and select **Properties** to display the following.

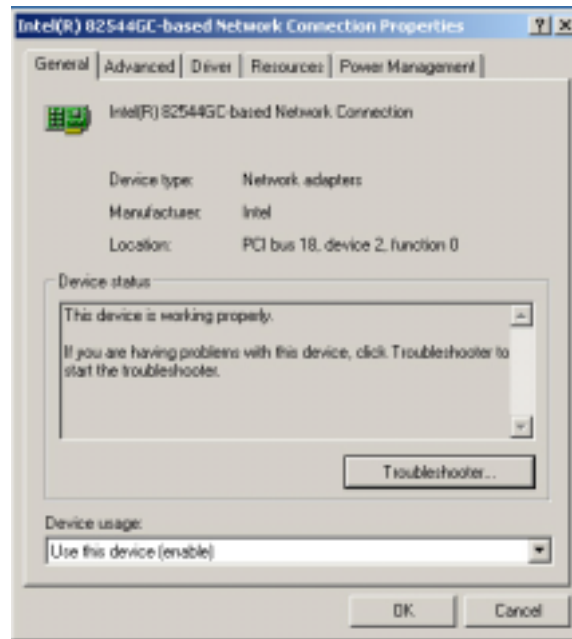

4. Highlight the **Intel(R) PRO-1000 Server Adapter**, click the right mouse button, and select **Properties** to display the following.

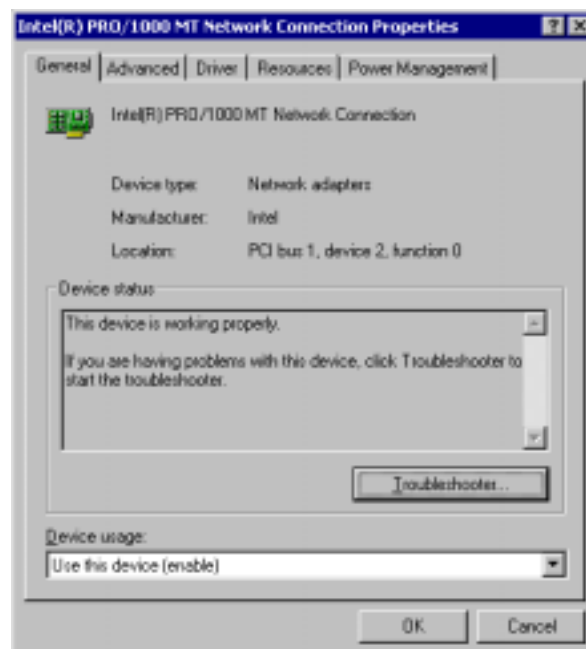

C. Updating the LAN driver using the LAN driver disk

You may also update the LAN drivers from the LAN Driver Disk if you created one in section “A. Preparing the Intel 82544GC/82540EM LAN Driver Disk.”

Follow these steps to update from the LAN driver disk.

1. Boot Windows XP system and log on as Administrator.
2. Click on the **Start** button. Select **Settings**, then **Control Panel**.
3. Double-click the **System** icon in the Control Panel. Select the **Hardware** tab to display the following screen.
4. Click on **Device Manager**, then on **Other Devices**.

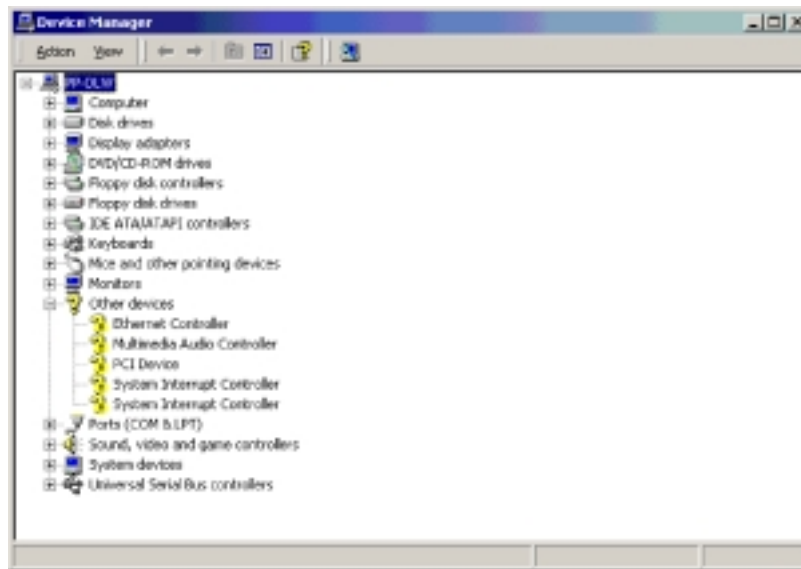

5. Highlight **Ethernet Controller**, then click the right mouse button and select **Properties**.
6. Select the **Driver** tab and click on **Update Drivers**.
7. Click **Next**. Select **Display a list of the known drivers for this device ...**
8. Select **Network adapters** under Hardware Type, and click **Next**.
9. Click **Have Disk...**, then insert the LAN driver disk.
10. Follow the succeeding instructions to complete the installation.

5.4.3 ATI® Rage XL Display Driver Installation

Windows XP system can automatically recognize the ATI RAGE XL PCI driver during system installation. You do not need to load any driver for supporting the onboard ATI RAGE XL graphics controller chipset.

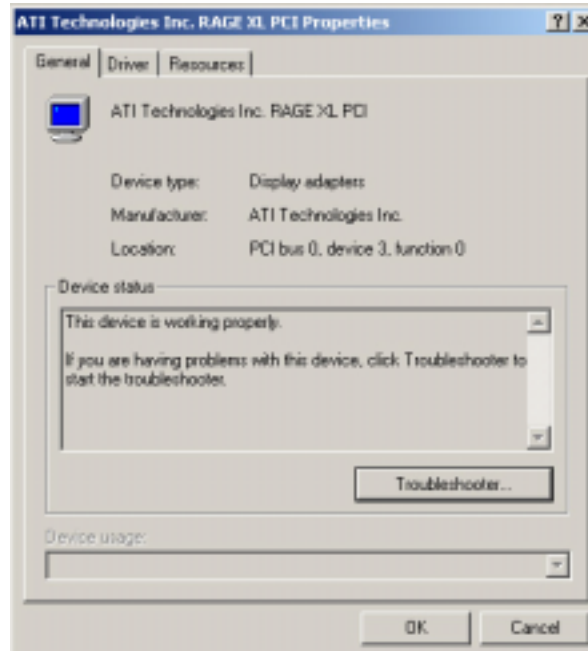

5.5 Novell® NetWare® Server

5.5.1 Adaptec® SCSI Driver Installation



The Adaptec® SCSI Driver appears only on PU-DLS models.

A. Preparing an Adaptec Ultra320 FMS driver disk

1. Insert a blank formatted high density floppy disk into the floppy drive.
2. Place the support CD into the CD-ROM drive. The Drivers menu appears displaying the available drivers.
3. Select the appropriate item to create an Adaptec Ultra320 FMS driver disk for Novell Netware.
4. Follow the screen instructions to complete the installation.

B. Installing NetWare 5.X/6.0 with an Ultra320 SCSI Controller

Follow these steps to install Netware 5.x/6.0 for the first time with an Ultra320 SCSI controller.

1. Begin installation of NetWare on your server as instructed in your NetWare documentation.
2. When a screen appears that asks to add device drivers, choose MODIFY and press ENTER.
3. Choose STORAGE ADAPTERS, and press ENTER.
4. Press Insert to add storage devices.
5. Press Insert to add an unlisted driver.
6. Insert the Adaptec Ultra320 FMS Driver disk for NetWare into the floppy drive.
7. Press F3 and specify the path to the ADPU320.HAM driver. For NetWare 5.1 and 6.0, select:

`A:\NETWARE\V51_V60\`

For NetWare 5.0, select:

`A:\NETWARE\V42_V50\`

8. Select ADPU320.HAM and press ENTER.
9. Select "Return to driver list" to accept the default slot number, and press ENTER.
10. Press ESC, select "Return to driver summary" and press ENTER.
11. Press ESC, select "Continue" and press ENTER.

C. Installing NetWare 4.2 with an Ultra320 SCSI Controller

1. Begin installation of NetWare on your server as instructed in your NetWare documentation.
2. When the screen "Choose the Server Drivers - Summary" appears, select "Select additional or modify selected Disk/LAN drivers" and press ENTER.
3. Highlight "Disk and CD-ROM Drivers" and press ENTER.
4. Highlight "Select an additional driver" and press ENTER.
5. When the screen "Choose the Server Drivers - Disk Driver" appears, press INSERT.
6. Insert the Adaptec Ultra320 FMS Driver disk for NetWare into the floppy drive.
7. Press F3 and specify the path to the ADPU320.HAM driver:
`A:\NETWARE\V42_V50\`
8. Select ADPU320.HAM and press ENTER.
9. When the message "Choose the Server Drivers - Disk Driver Parameters" appears, select "Save parameters and load driver".
10. When prompted, press ENTER to select the slot number. Repeat until all slot options are loaded.
11. Select "Continue installation" to continue the installation.

NOTE To load the driver automatically at server bootup, make sure that the STARTUP.NCF file includes the line:

LOAD ADPU320.HAM SLOT=<XX>.

D. Installing the Adaptec driver with existing NetWare 5.X/6.0

1. Make a backup copy of the old driver (if it exists) before installing the new driver.
2. At the NetWare console prompt type:
LOAD NWCONFIG
3. Select "Driver Options (load/unload disk and network drivers)" and press ENTER.
4. In the Driver Options menu select "Configure disk and storage device drivers" and press ENTER.
5. Select "Select an additional driver" and press ENTER.
6. Press Insert to add an unlisted driver.
7. Insert the Adaptec Ultra320 FMS Driver disk for NetWare into the floppy drive.
8. Press F3 and specify the path to the ADPU320.HAM driver.
For NetWare 5.1 and 6.0, select:

A:\NETWARE\V51_V60

For NetWare 5.0, select:

A:\NETWARE\V42_V50

9. Select ADPU320.HAM and press ENTER.
10. When prompted, click Yes to copy the driver.
11. Specify the path where the driver ADPU320.HAM should be installed, or press ENTER to accept the default.
12. When prompted, click Yes to save the existing driver and its information file.
13. Choose "Select/Modify driver parameters" and press ENTER.
14. Press Alt-Esc to switch to System Console, and at the prompt, type:
LOAD A:\NETWARE\V51_V60\ADPU320.HAM (for NetWare 5.1/6.0)

or

LOAD A:\NETWARE\V42_V50\ADPU320.HAM (for NetWare 5.0)

15. Write down the HIN value displayed on the screen and select 0 to continue. Ignore the message regarding the ADPU320.HAM not being loaded.
16. At the prompt, press Alt-Esc to return to the nwconfig screen.
17. Enter the HIN value in Slot Number and press ENTER.
18. Select "Save parameters and load driver" and press ENTER.
19. Click No at the prompt "Do you want to select an additional Disk driver?"
20. Press Esc until return to the Configuration Options screen.

E. Installing the Adaptec driver with existing NetWare 4.2

1. At the NetWare console prompt type:
LOAD INSTALL
2. Select "Driver Options (load/unload disk and network drivers)" and press ENTER.
3. In the Driver Options menu select "Configure disk and storage device drivers" and press ENTER.
4. Select "Select an additional driver" and press ENTER.
5. Press Insert to add an unlisted driver.
6. Insert the Adaptec Ultra320 FMS Driver disk for NetWare into the floppy drive.
7. Press F3 and specify the path to the ADPU320.HAM driver:
A:\NETWARE\V42_V50
8. Select ADPU320.HAM and press ENTER.
9. When prompted, click 'Yes' to copy the driver.
10. Specify the path where the driver ADPU320.HAM should be installed, or press ENTER to accept the default.
11. When prompted, click 'Yes' to save the existing driver and its information file.
12. When prompted to enter the Slot Number, press ENTER to select "Save parameters and load driver".

13. When prompted, press ENTER to select the slot number. Repeat until all slot options are loaded.
14. Click "No" at the prompt "Do you want to select an additional Disk driver?"
15. Press Esc until return to the Configuration Options screen.

F. Removing the Driver From a NetWare Server

1. Type LOAD NWCONFIG at the NetWare console prompt and press ENTER.
2. Select "NCF Files Option (Create/Edit server Startup files)".
3. Select "Edit STARTUP.NCF file".
4. Remove the line(s) for loading ADPU320.HAM driver.
5. When finished, press F10 to save and exit.
6. Press ESC twice to quit NWCONFIG utility.

NOTE A DOS text editor can also be used to modify the STARTUP.NCF file.

5.5.2 Intel® 82544GC/82540EM LAN driver installation



It is recommended that you use the Intel 82544GC/82540EM LAN drivers from the support CD.

A. Preparing the Intel 82544GC/82540EM LAN driver disk



Prepare one blank formatted high density floppy disk before proceeding.

Follow these steps to install the LAN drivers from the support CD.

1. Insert the support CD into the CD-ROM drive.
2. On the screen that appears, select **Create Install Disk**.



3. The next screen allows you to select an operating system to install the driver. Select Windows Novell Netware.
4. Select A:\ for the destination drive, then click on **Create Disk**. (See picture on the next page.)



5. Follow the succeeding installation instructions.
6. When done, the following screen appears. Click **Finish** to complete the installation.



B. NetWare 4.2 and 5.x/6.0 Installations

1. Prepare the Intel(R) PRO/1000 Server Adapter driver from the previous section.
2. Install NetWare 4.2 according to the NetWare instructions.
3. When the NetWare installation procedure prompts you for a Network Driver, insert the Intel PRO/1000 driver disk into drive **A:** Then use the **INS** key to select an unlisted driver. A dialog box appears. The **“CE100B.LAN — Intel 825XX PCI Adapter (CHSM spec 1.11) “** driver appear as a selection.



If the “Loader could not find public symbol: <symbol name>” error message prompted when system is loading Intel Pro/100+ PCI network driver, it is because the related network driver modules are too old. Download the latest Netware Support Pack from Novell web site at: <http://support.novell.com/products/nw411/patches.htm>

4. Installation of the Intel 82544GC/82540EM Network Adapter for NetWare 4.2 or 5.x/6.0 is complete.

Add or check the load and bind statements you need to the server's AUTOEXEC.NCF file so the PRO/1000 adapter driver loads automatically load and bind the server driver as follows:

```
LOAD CE100B SLOT=x FRAME=ETHERNET_802.2
```

```
BIND IPX TO CE100B NET=xxxxxxxx
```

where: SLOT=x Specifies the NBI (NetWare Bus Interface) slot number. Substitute x with the valid value for the adapter. You will be prompted with the slot number(s) of installed PRO/100+ adapters. The NBI numbers are different from the slot number indicated in the SETUP.EXE utility.

NET=xxxxxxxx is the unique network address for that LAN segment. The default frame type is 802.2. If your workstation needs to use the 802.3 frame type, see the section later in this document about using multiple frame types on one adapter.

5.5.3 ATI® Rage XL Display Driver Installation

You can select the “Super VGA” for the X Server on NetWare 5.x server system. The other NetWare system didn't support X Server and you didn't need the VGA driver support.

5.6 SCO Open Server 5.0.6

5.6.1 Intel® 82544GC/82540EM LAN Driver Installation

SCO OpenServer 5.0.6 system can correctly recognize Intel 82544GC/82540EM LAN controller during installation. You do not need to load or modify the network driver for the onboard LAN device.

User also can find the Intel 82544GC/82540EM Network driver from the support CD at:

```
\Drivers\Lan\openunix\
```

A. Installing the eeE Driver for SCO OpenServer

1. Copy the `eee.vol` file to any directory, say `/tmp`, on the SCO system, renaming the file as `VOL.000.000`. Also, make the file read-only by using `'chmod'`.

For example,

```
# cp eee.vol /tmp/VOL.000.000
```

```
# chmod 444 /tmp/VOL.000.000
```

2. If there is an older version of the driver on the system, you must first remove it. To do this, run `'netconfig'`. Remove all instances of the "Intel ..." adapters. Exit `netconfig` without opting to relink the kernel.
3. Install the new driver using `'custom'`. When asked for the installation media, choose `'media images'`, and type the directory path to the `VOL.000.000` file. (In step 1, if you copied it to `/tmp`, type `'/tmp'`). After the installation of the driver is complete, exit `'custom'`.
4. Run `'netconfig'` and add the adapters. For each adapter that is present in the system, enter the appropriate TCP/IP parameters. By default, the driver automatically detects the line speed and duplex mode. If you want to force any of these settings, choose `'Advanced Options'` and set the speed and duplex modes. Exit `'netconfig'` and choose to relink the kernel.
5. Reboot the system. At the command prompt, type:

```
# reboot (or init 6)
```

5.6.2 ATI® Rage XL Display Driver Installation

SCO OpenServer 5.0.6 system can correctly recognize ATI Rage XL graphic controller (ATI RAGE PRO/LT-PRO/XL/Mobility (P/M/M1)) during installation. User doesn't need to load or modify the video driver for the onboard VGA device.

5.7 Linux RedHat 8.0

5.7.1 Adaptec® SCSI Driver Installation



The Adaptec® SCSI Driver appears only on PU-DLS models.

A. Preparing an Adaptec RedHat driver disk



You must perform the following procedure under Linux environment.

To create an Adaptec RedHat driver disk:

1. Prepare a blank formatted high density floppy disk.
2. Decompress the file **aic79xx-1.2.0-i686-rh80.img.gz** into the floppy disk from the following path:

`\drivers\adaptec\7902\linux\Red Hat`

B. Installing Linux RedHat 8 with AIC7902

1. Boot from the RedHat CD-ROM.
2. At the boot menu, type `linux dd`, then press Enter.
3. Insert the Adaptec RedHat driver disk when prompted.
4. Follow the screen instructions to complete the installation.

5.7.2 Intel® 82544GC/82540EM LAN Driver Installation

This file describes the Linux* Base Driver for the Intel PRO/1000 Family of Adapters, version 4.1.x. This driver is intended for 2.2.x and 2.4.x kernels; it is known to build properly on 2.2.x kernels through 2.2.20 and on 2.4.x kernels through 2.4.17. Intel focused testing on Intel processor-based systems running kernels 2.4.7 and 2.2.16. This driver includes support for Itanium®-based systems.

The Intel PRO/1000 driver is only supported as a loadable module at this time. Intel is not supplying patches against the kernel source†to allow for static linking of the driver. For questions related to hardware requirements, refer to the documentation supplied with your Intel PRO/1000 adapter. All hardware requirements listed apply to use with Linux.

New features include support for the Intel PRO/1000 desktop adapter.

A. Updating Driver on an Existing System Installation

To build a binary RPM* package of this driver, run

```
'rpm -tb <filename.tar.gz>'
```

Replace <filename.tar.gz> with the specific file name of the driver.

1. Move the base driver tar file to the directory of your choice. For example, use:

```
'/home/username/e1000' or '/usr/local/src/e1000'
```



For the build to work properly, the currently running kernel **MUST** match the version and configuration of the installed kernel sources. If you have just recompiled the kernel reboot the system now.

5.7.3 ATI® Rage XL Display Driver Installation

The RedHat 8.0 system can automatically recognize ATI Rage XL graphic controller (ATI MACH64) during installation. You don't need to load or modify the video driver for the onboard VGA device.