

Using jogger soft case SL-CT476J

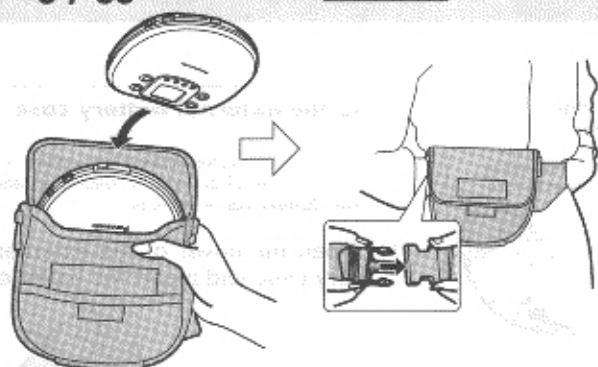

1. Make sure the anti-shock function is ON.
2. Before jogging with this unit, allow sufficient time for the memory buffer to fill up completely (ideally 40 seconds).
3. Fasten the neoprene sport belt securely around your waist so that the unit fits snugly against your body.
4. Be sure the CD player is placed in the pouch so that the buttons are facing away from your body.
5. This unit is designed for light jogging, but not for serious running. It may occasionally skip if used by an aggressive runner, or by someone with a heavy, jarring stride.

Note

- Do not machine wash. Fading and loss of shape can occur.
- Do not expose the pouch to high temperatures when a player and CDs are inside. The player and CDs can be damaged and it can lead to fire. Be especially careful not to leave the pouch near heaters, in a car, or in the sun.
- Do not drop or hit the pouch while a player and CDs are inside. This can seriously damage the player and CDs.
- Discontinue use if a rash or skin irritation develops.
- Take special care when listening to CDs around traffic.

Portable CD player

Dear Customer

Thank you for purchasing this product. For optimum performance and safety, please read these instructions carefully.

The model number and serial number of this product can be found on either the back or the bottom of the unit. Please note them in the space provided below and keep for future reference.

MODEL NUMBER _____
SERIAL NUMBER _____

SL-CT476J model only for U.S.A.

Panasonic

Operating Instructions

Model No.

SL-CT470
SL-CT476J



COMPACT
DISC
DIGITAL AUDIO

Supplied Accessories

Check the packing carton for these accessories.

AC adaptor 1 pc.
(RFEA415C-1S)

For U.S.A.

Stereo headphones 1 pc.

SL-CT470

(RFEV715P-SS)

SL-CT476J

(RFEV716P-SS)

For Canada

Stereo earphones 1 pc.

(RFEV334P-KS)

Nickel-metal hydride rechargeable batteries with carrying case . . . 1 pc. (RPFK4HR4AHBA)

Remove the rechargeable batteries from their case before use. If the inner tray is removed, the case can be used to carry two "AA" (LR6) batteries, used in the external battery case.

External battery case 1 pc. (RFA1139-H)

SL-CT476J ONLY

Wired remote control 1 pc. (RFEV033P-SS)

Jogger soft case 1 pc. (RFC0060-K)

Use numbers indicated in parentheses when asking for replacement parts. (Only for U.S.A.) To order accessories contact 1-800-332-5368 or web site (<http://www.panasonic.com>).

Panasonic Consumer Electronics Company, Division of Matsushita Electric Corporation of America
One Panasonic Way Secaucus, New Jersey 07094 <http://www.panasonic.com>
Panasonic Sales Company, Division of Matsushita Electric of Puerto Rico, Inc. ("PSC")
Ave. 66 de Infantaria, Km. 9.5 San Gabriel Industrial Park, Carolina, Puerto Rico 00985
Panasonic Canada Inc.
5770 Ambler Drive, Mississauga, Ontario L4W 2T3 www.panasonic.ca
© 1999 Matsushita Electric Industrial Co., Ltd.

En

Before connecting, operating or adjusting this product, please read these instructions completely. Please keep this manual for future reference.

P PC

SL-CT470 : indicates a feature which can be enjoyed with SL-CT470 only.

SL-CT476J : SL-CT476J only.

RQT5350-P F1299KKC (D)
Printed in Japan

Precautions

Before using this unit, be sure to read the applicable items of the operating instructions and these safety suggestions carefully.

Afterwards keep them handy for future reference. Take special care to follow the warnings indicated on the unit itself as well as in the operating instructions.

Safety

1. **Power Source**—The unit should be connected to power supply only of the type described in the operating instructions or as marked on the unit. Use only the AC adaptor or car adaptor described in the operating instructions when recharging.
2. **Polarization**—If the unit is equipped with a polarized AC power plug (a plug having one blade wider than the other), that plug will fit into the AC outlet only one way. This is a safety feature. If you are unable to insert the plug fully into the outlet, try reversing the plug. If the plug should still fail to fit, contact your electrician to replace your obsolete outlet. Do not defeat the safety purpose of the polarized plug.
3. **Care of AC adaptor**—Take care that the cord of the AC adaptor should be routed so that they are not likely to be walked on or pinched by items placed upon or against them. Never take hold of the AC adaptor if your hand is wet, and always grasp the plug body when connecting or disconnecting it.
4. **Nonuse Periods**—When not in use, be sure to disconnect the AC adaptor from the AC power outlet.
5. **Batteries**—If the set is not used for a long period of time or is used only from an AC power source, remove all the batteries to prevent potential damage due to possible battery leakage. Do not mix batteries (old and new) or different types of batteries.

Installation

Environment

1. **Water and Moisture**—Do not use this unit near water—for example, near a bathtub, washbowl, swimming pool, or the like. Damp basements should also be avoided.
2. **Condensation**—Moisture may form on the lens in the following conditions.
 - immediately after a heater has been turned on.
 - in a steamy or very humid room.
 - when the unit is suddenly moved from a cold environment to a warm one. If moisture forms inside this unit, it may not operate properly. To correct this problem wait about one hour for the moisture to evaporate.
3. **Heat**—Never use or place this unit near a heat source. Do not leave it in an automobile exposed to direct sunlight for a long time with the doors and windows closed as this may deform the cabinet.

Placement

1. **Foreign Material**—Care should be taken so that objects do not fall into and liquids are not spilled into the unit. Do not subject this unit to excessive smoke, dust, mechanical vibration, or shock.
2. **Magnetism**—The unit should be situated away from equipment or devices that generate strong magnetic fields.
3. **Stacking**—Do not place any objects, on top of the unit.

Maintenance

(See page 7 for details.)
Clean the cabinet, panel and controls with a soft cloth lightly moistened with mild detergent solution. Do not use any type of abrasive pad, scouring powder or solvent such as alcohol or benzene.

Service

1. **Damage Requiring Service**—The unit should be serviced by qualified service personnel when:
 - (a) The AC adaptor is damaged; or
 - (b) Objects have fallen or liquid has been spilled into the unit; or
 - (c) The unit has been exposed to rain; or
 - (d) The unit does not appear to operate normally or exhibits a marked change in performance; or
 - (e) The unit has been dropped, or the enclosure damaged.
2. **Servicing**—The user should not attempt to service the unit beyond that described in the operating instructions. All other servicing should be referred to an authorized service personnel.
For the address of an authorized servicenter:
In the U.S.A. 1-800-211-7262 or web site (<http://www.panasonic.com>)
In Canada 905-624-5505 or web site (www.panasonic.ca)



This manual was printed with soy based ink.

Power Supply Preparations

Refer to the specifications (page 8) for information on operating times when using rechargeable batteries or dry-cell batteries.

Using rechargeable batteries

Make sure to recharge the batteries before using them. The unit cannot be used to charge rechargeable batteries other than those specifically designed for it.

- Supplied batteries (HHR4AHEBA1)
- Optional batteries (HHR-4AHA/2B)

Recharging procedure

- 1 Insert the special rechargeable batteries into the unit.

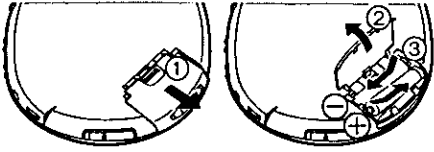

- 2 Connect the AC adaptor.

DC IN jack (DC IN 4.5 V)

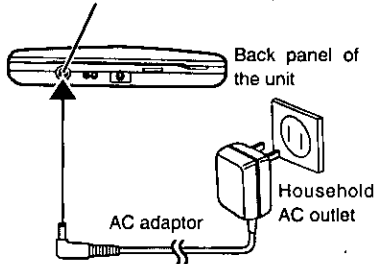

Recharging starts and the "CD" charging indicator flashes on and off on the unit's display.

When the rechargeable batteries are fully recharged, the charging indicator disappears. (It takes approximately 3 hours to fully recharge the supplied rechargeable batteries.)

- 3 When recharging is complete, unplug the AC adaptor from the household AC outlet and the DC IN jack.

Note

- Rechargeable batteries have a service life of approximately 300 charge-discharge cycles. If the operating time on one full charge becomes noticeably shorter than it used to be, the battery has reached the end of its service life and should be replaced.
- Recharging may only be performed when the unit is powered off. (It is not possible to recharge the batteries while playing a CD.)
- The AC adaptor and rechargeable batteries may become warm while recharging is in progress. This is not a malfunction.

If the battery lid comes loose
Slide the lid back into place horizontally.

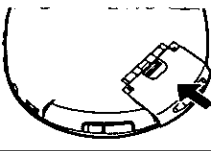

Removing batteries
Push up on the battery in the direction indicated by the arrow. Then lift it out.

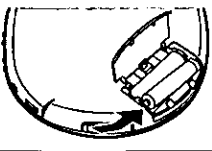

Using the AC adaptor

Connect the AC adaptor supplied.

Refer to the step 2 in "Using rechargeable batteries" for connection instructions.

Conserving power

The AC adaptor consumes 1.8 W when the unit is turned off with [■, OPR OFF]. To save power when the unit is not to be used for a long time, unplug the AC adaptor from the household AC outlet. Reprogram tracks if necessary before use.

Using the car adaptor (not included)

Be sure to obtain the car adaptor (SH-CDC9), available as an optional accessory.

CAUTION:

Use only car adaptor, Model: SH-CDC9 manufactured by Matsushita Electric Industrial Co., Ltd.

The car adaptor can be used to recharge the unit's batteries while in the car.

Using dry cell batteries (not included)

After disconnecting the AC adaptor, insert two "AAA" (LR03) alkaline batteries.

The procedure for inserting and removing dry-cell batteries is identical to that for rechargeable batteries.

When the battery indicator flashes

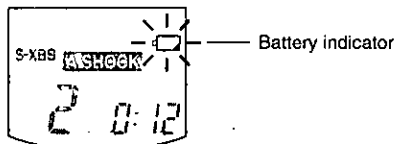

Power is cut off a short while later. Recharge the rechargeable batteries or replace the dry cell batteries with new ones.

Note

- The length of time the unit will continue to operate between when the battery indicator starts flashing and when the power is cut off differs depending on the type of batteries used.
- The battery indicator may not be displayed if rechargeable batteries other than those designated by Panasonic are used.

Using the external battery case

The external battery case allows you to extend the maximum playing time of the unit by loading an additional two "AA" (LR6) alkaline batteries.

- 1 Open the cover of the external battery case and insert the batteries.

Insert the end marked (-) first.

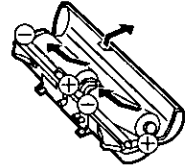

- 2 Mount the external battery case on the unit body.

Insert the protrusions on the external battery case into the three indentations in the unit body.

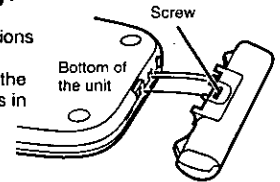

- 3 Secure in place with the screw.



Reverse the above procedure to remove the external battery case.

For your reference:

- The unit can be powered by the batteries in the external battery case alone. No batteries need to be loaded in the player.
- The maximum playing time depends on the type of batteries (rechargeable/dry-cell) loaded in the unit body.

If the cover of the external battery case comes loose:

Insert the protrusions on the cover into the holes in the case.

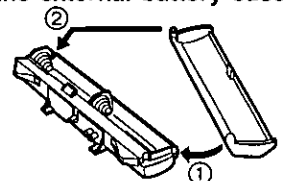

Note

- Though you can use rechargeable batteries in the external battery case, it does not recharge them. (Use dry cell batteries if possible.)
- If rechargeable batteries and dry-cell batteries are used together, make sure to use fully charged rechargeable batteries and new dry-cell batteries.
- When using four dry-cell batteries, do not mix new and old batteries.

If the unit malfunctions or freezes during use, disconnect the power sources (the AC adaptor or batteries).

Re-connect the power source and continue operation.

HOLD function

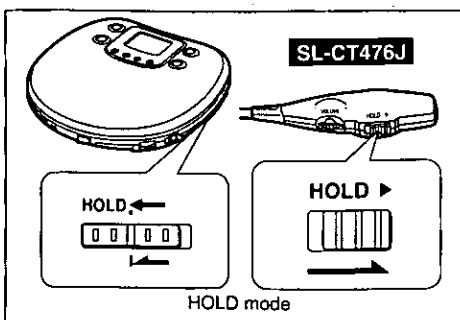

This function causes the unit to ignore short, accidental button presses. (The disc lid can still be opened and closed.)

The HOLD function prevents the following:

- Powering on the unit accidentally (which can cause the batteries to run down).
- Play being cut off unexpectedly in the middle of a selection.

To use the HOLD function

Set [HOLD] to the HOLD position.

SL-CT476J

The unit and wired remote control have HOLD functions, each of which works independently.

"hold" indication

When the unit is in HOLD status, pressing any button causes the indication "hold" to appear on the display.

When the unit is powered off

The "hold" indication appears only when [▶] is pressed.

Before operating the buttons

Be sure to move [HOLD] to release the unit from the hold mode.

Sequential Play Basic Play

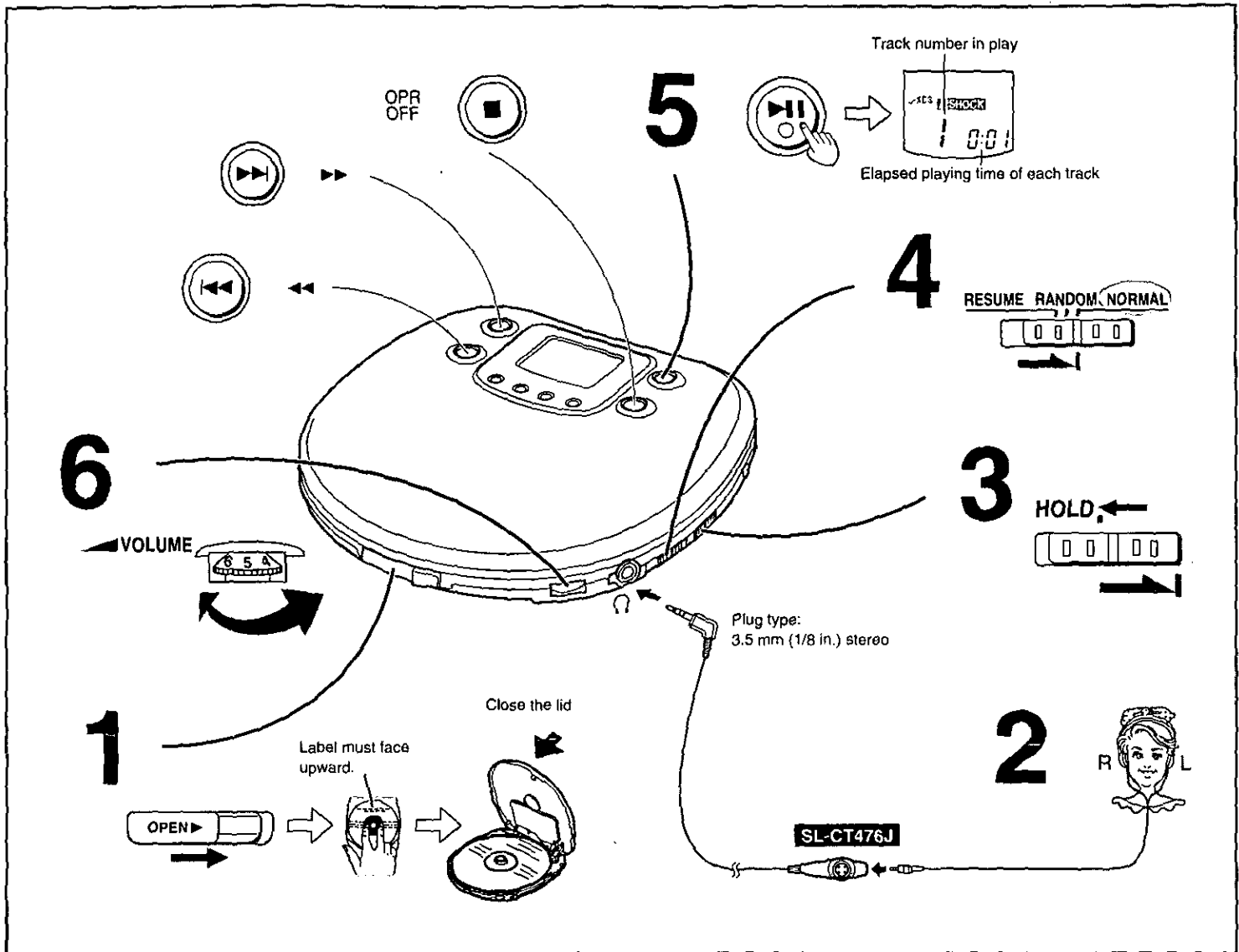

Follow steps 1-6.

In step 2, connect the stereo headphones/stereo earphones and wired remote control (SL-CT476J) to the headphone jack (Q). (Plug in firmly)

- Play stops automatically when all the tracks have been played.
- If the unit has been connected to the car audio system, adjust the volume level between 4 and 6 on the unit, then adjust the volume level on the system.

For your reference:

"no disc" indication

This indication appears for about 30 seconds if [PAUSE] is pressed when no disc is loaded in the unit or if the disc is not properly secured.

"OPEN" indication

This indication appears for about 10 minutes when the cover is opened. (However, the indication does not appear when the unit is powered off.)

Auto power off function

If the unit is left in stop or paused status for approximately 10 minutes, the unit powers itself off automatically in order to prevent the batteries from running down. (If no disc is loaded in the unit it powers itself off in about 30 seconds.)

Removing discs

1 Press [STOP, OPR OFF] to stop play and disc's rotation.

2 Slide [OPEN] to open the lid.

3 Press [PUSH] to release the disc.

Do not stop the disc by hand or try to remove it before it stops rotating. This can damage CDs.

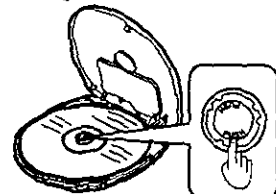

Note

Never insert foreign objects into the unit body.

Operation	Button	Display/reference
To pause play	Press during play. 	 Press again to restart play.
To stop play Stop mode	Press during play. OPR OFF	Total playing time Total number of tracks
To turn off the unit Off mode	Press during stop mode. OPR OFF	
Skipping tracks	Press during play. Backward Forward	<ul style="list-style-type: none"> • During program play (page 4), these buttons are used to skip forward or back through the programmed sequence of tracks. • During random play (page 4), the skip buttons cannot be used to skip back to tracks that were played previously in the random sequence. • During program play, random play or 1-track repeat play (page 4), search operation is limited to the current track only.
Searching through tracks	Press and hold during play. 	



Other Play Methods

The letters such as **A** in the various illustrations refer to the descriptions in the "Location of Controls" section.

Skip play

The disc plays from the selected track through to the last track, then play stops automatically.

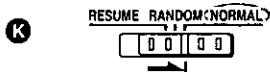



Preparation: Put unit in stop mode.

- 1** 
- 2** Select the desired track. 
- 3** 

Program play

Up to 24 tracks can be entered in the program.

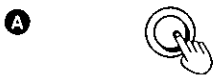
Preparation: Put unit in stop mode.

- 1** 
- 2** Select the desired track. 
- 3** Register in sequence. (The indication "M" and the programmed sequence appear on the display.) 
- 4** Repeat steps 2 and 3 to program all the desired tracks.
- 5** 

■ To program the same track in the sequence more than once

After step 3, press [MEMORY/RECALL] desired number of times.

■ If "f" is displayed

No more tracks may be programmed.



■ To confirm the contents of the program

Press [MEMORY/RECALL] while the disc is playing. (The numbers of the programmed tracks appear on the display in sequence.)

■ To delete the entire program

Press [M, OPR OFF].

Random play

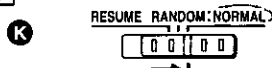
- 1** 
 - 2** 
- Release 

For your reference:

• It is also possible to press [▶▶] while the unit is in stop mode to change the first track to be played. (All tracks are played eventually, regardless of which is played first.)

• Program play is not possible in the random mode.

Resume play

This function allows you to listen from the beginning of the track where play stopped because the unit was powered off (or switched to stop mode). It is useful when listening to CDs in the car, etc.

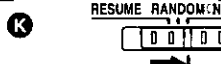
- 1** 
- 2** 

For your reference:



• If [RESUME, RANDOM, NORMAL] is put in the [RESUME] position, the all-track repeat function will be activated automatically as soon as the unit is powered on.

• If power is cut off near the end of a track (off mode), playback may resume from the beginning of the next track in some cases.

• If the unit is powered off while a disc was playing and then a new disc is inserted, play will begin from the middle of the new disc because the unit remembers the position where play stopped on the previous disc.

Repeat function

Press during play or stop mode.

- 1** 
- The setting is switched in the sequence indicated below each time [E] is pressed.
- 1-track repeat (1 )
One track is repeated.
 - All-track repeat (ALL )
All the tracks on the disc are repeated.
 - Cancel (no indicator is shown)

For your reference:

If [E] is pressed during program play, only the tracks in the program are repeated.

(The indication "ALL" is not displayed.)

Changing the sound quality

Press during play or stop mode.

- 1** 
- The setting switches in the sequence indicated below each time [EQ] is pressed.
- S-XBS → TRAIN → LIVE → Cancel (no indicator is shown)

S-XBS:

Select this setting to boost the low-range response.

TRAIN:

Select this setting to avoid annoying other passengers with noise from your headphones/earphones while riding on the train, or to reduce fatigue when listening for a long period of time.

LIVE:

Select this setting for a live concert effect.

Location of Controls

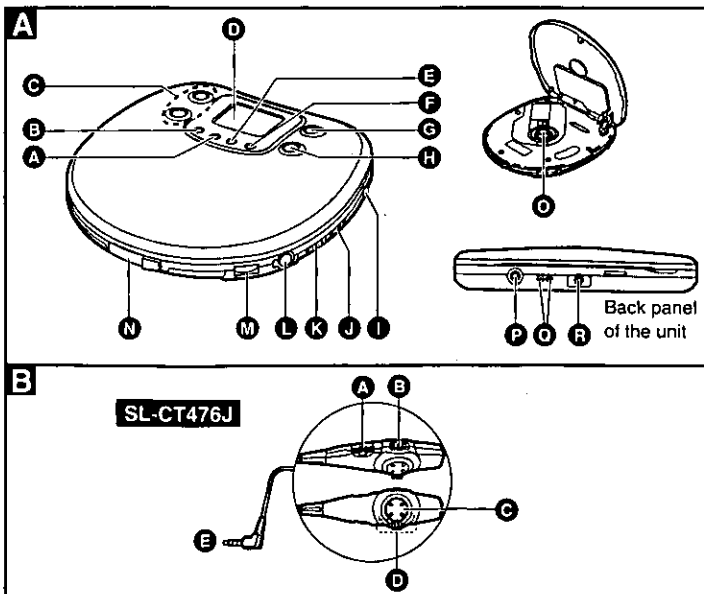

Portable CD player

- A** Memory/recall button (MEMORY/RECALL)
- B** EQ button (EQ)
- C** Skip/search buttons (◀, ▶, ◀◀, ▶▶)
- D** Display
- E** Repeat button (◁)
- F** Anti-shock button (A. SHOCK)
- G** Play/pause button (▶||)
- H** Stop/operation off button (■, OPR OFF)
- I** Out jack (OUT)
- J** Hold switch (HOLD)
- K** Play mode selector (RESUME, RANDOM, NORMAL)
- L** Headphone jack (◻)
- M** Headphone volume control (VOLUME)
- N** Open switch (OPEN)
- O** CD release button (PUSH)

- P** DC IN jack (⊕ ⊖ DC IN 4.5 V)
- Q** Connection terminal for external battery case
- R** Hole for car insulator mounting screw/external battery case

Wired remote control

SL-CT476J 

- A** Volume control (VOLUME)
- B** Hold switch (HOLD)
- C** Play/stop/off button
- D** Skip/search selector (+, -)
- E** Plug

Anti-Shock Function

The letters such as **A** in the various illustrations refer to the descriptions in the "Location of Controls" section (See page 4.).

The anti-shock function works by reading audio data and storing it in memory (up to 40 seconds worth). The unit then fills in interruptions caused by bumps and vibrations with data from the memory. This unit also incorporates a powerful anti-shock mechanism that prevents skipping caused when play speed is changed by swinging of the unit.

Press during play or stop mode.

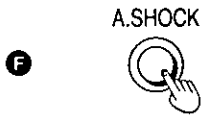

The following indicator appears on the display.

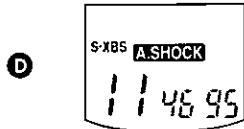

Note

If you have pressed [A.SHOCK] when the unit is in stop mode, press [▶||] to start play.

When bumps continue repeatedly

The message "SORRY" appears on the display and sound is interrupted.



To cancel the anti-shock function

Press [A.SHOCK] again.

Note

- The anti-shock setting can be changed during play, but this may cause a slight interruption in the sound because the disc's rotational speed changes.
- During the anti-shock operation, the disc rotates at a higher rate than usual in collecting extra audio data. This could result in a slight increase in disc rotation noise.

Listening to sound with the unit connected to an audio system

The anti-shock function uses digital signal compression technology. It is recommended that the anti-shock function be canceled if the unit is connected to a home audio system.

Using the Wired Remote Control SL-CT476J

The remote control can be operated regardless of the hold mode of the unit.

Preparation:

Release the remote control from the hold mode.

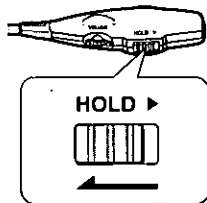

■ Operation confirmation tones

When an operation button is pressed, a confirmation tone sounds. Refer to the parentheses in the illustration for the different types of confirmation tones.

How to use the wired remote control

To start play	Press once during off or stop mode. (Beep)	Turning during play. Backward (Beep Beep Beep) Forward (Beep Beep) Turn and hold during play.
To stop play	Press once during play. (Beep...Beep)	
To turn off the unit	Press and hold during play or stop mode. (Beep...Bee...p)	
To adjust the volume	When adjusting the volume using the remote control, position the volume control on the unit between 4 and 6. VOLUME HOLD ▶	

Using the Unit with Optional Accessories

Using the unit with an audio system

Use stereo connection cable (not included) to listen to CDs through your home audio system.

- Turn off the amplifier power and connect the cable.
- Do not connect the cable to the PHONO jacks on the amplifier.
- Obtain the optional connecting cable if the amplifier comes with mini-phone jacks.
- Adjust the volume on the amplifier.

Note

- Sound quality changes when S-XBS, TRAIN or LIVE is selected, but volume is reduced by about half.

SL-CT476J

- You can connect speakers, active or otherwise, with an impedance of 1 kΩ or less to the headphone jacks. Set the unit's volume between 4 and 6.

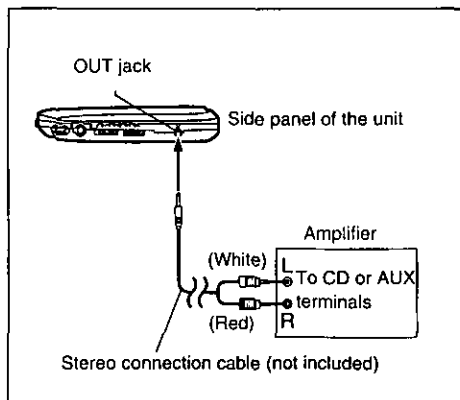

Using the unit with a car audio system

Items to be purchased

For connection to the car audio system:
Car stereo cassette adaptor (SH-CDM10A)

Connect the car stereo cassette adaptor to the unit's headphone jack.
(When doing this, keep the unit's VOLUME at a setting between 4 and 6.)

For securing the unit and connecting the power supply:

- Car adaptor (SH-CDC9)
- Car mounting kit (SH-CDF7)
- Car mounting arm, Car insulator

Note

It may not be possible to use the unit with some types of car stereos owing to restrictions imposed by the construction of the car stereo cassette adaptor.

For further details, refer to the instructions of the part concerned.

ONLY FOR U.S.A.

For Product Information, Operating Assistance, Literature Request, Dealer Locations, and all Customer Service inquiries please contact:
1-800-211-PANA (7262), Monday-Friday 9 am-9 pm; Saturday-Sunday 9 am-7 pm, EST.

Web Site: <http://www.panasonic.com>
You can purchase parts, accessories or locate your nearest servicer by visiting our Web Site.

Accessory Purchases:

1-800-332-5368 (Customer Orders Only)
Panasonic Services Company 20421 84th Avenue South, Kent, WA 98032
(6 am to 5 pm Monday-Friday; 6 am to 10:30 am Saturday; PST)
(Visa, MasterCard, Discover Card, American Express, Check)

Factory Servicenters Locations

<p>CALIFORNIA 6550 Katella Avenue Cypress, CA 90630</p> <p>800 Dubuque Avenue S. San Francisco CA 94080</p> <p>20201 Sherman Way Suite 102 Canoga Park, CA 91306</p> <p>3878 Ruffin Road Suite A San Diego, CA 92123</p> <p>COLORADO 1640 South Abilene Street Suite D Aurora, CO 80012</p> <p>FLORIDA 3700 North 29th Avenue Suite 102 Hollywood, FL 33020</p>	<p>GEORGIA 8655 Roswell Road Suite 100 Atlanta, GA 30350</p> <p>ILLINOIS 9060 Golf Road Niles, IL 60714</p> <p>1703 North Randall Road Elgin, IL 60123 (Pick-up/Drop-off only)</p> <p>MARYLAND 62 Mountain Road Glen Burnie, MD 21061</p> <p>MASSACHUSETTS 60 Glacier Drive Suite G Westwood, MA 02090</p>	<p>MICHIGAN 37048 Van Dyke Avenue Sterling Heights, MI 48312</p> <p>MINNESOTA 7850-12th Avenue South Airport Business Center Bloomington, MN 55425</p> <p>OHIO 2236 Waycross Road Civic Center Plaza Forest Park, OH 45240</p> <p>PENNSYLVANIA 2221 Cabot Blvd. West Suite B Langhorne, PA 19047</p> <p>Chartiers Valley Shopping Center 1025 Washington Pike Bridgeville, PA 15017</p>	<p>TENNESSEE 3800 Ezell Road Suite 806 Nashville, TN 37211</p> <p>TEXAS 7482 Harwin Drive Houston, TX 77036</p> <p>13615 Welch Road Suite 101 Farmers Branch, TX 75244</p> <p>WASHINGTON 20425-84th Avenue South Kent, WA 98032</p> <p>HAWAII 99-859 Iwaiwa Street Aiea, Hawaii 96701 Phone (808) 488-1996 Fax (808) 486-4369</p>
---	--	--	--

Service in Puerto Rico
Matsushita Electric of Puerto Rico, Inc. Panasonic Sales Company/Factory Servicer:
Ave. 65 de Infanteria, Km. 9.5, San Gabriel Industrial Park, Carolina, Puerto Rico 00985
Phone (787) 750-4300 Fax (787) 768-2910

If you ship the product

Carefully pack and send it prepaid, adequately insured and preferably in the original carton. Attach a postage-affixed letter, detailing the complaint, to the outside of the carton.

Do NOT send the product to the Executive or Regional Sales offices. They are NOT equipped to make repairs.

Customer's Record

Model No. _____	Dealer's Name _____
Serial No. _____ or _____	_____
Code No. _____	Dealer's Address _____
Date of Purchase _____	_____

Concerning Compact Discs



Only compact discs bearing this mark can be used with this unit.

However, continued use of irregular shaped CDs can damage the unit.



How to remove a disc from its case **How to store the disc in its case**



How to hold a disc



If the surface is dirty

Wipe it with a damp cloth and then wipe dry.

Wipe from the center toward the outer circumference.

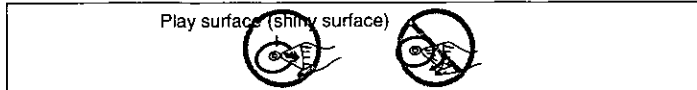

Handling precautions

- If you are taking the CD from a cold to a warm environment, moisture may form on the CD. Wipe this off with a soft, dry, lint-free cloth before using the CD.
- Do not write on the label side with a ball-point pen or other writing instrument.
- Do not use record cleaning sprays, benzene, thinner, static electricity prevention liquids or any other solvent.
- Do not attach labels or stickers to CDs. (Do not use CDs with exposed adhesive from tape or left over peeled off stickers.)

- Do not use scratch-proof protectors or covers other than those specified for use with this unit.
- Storage precautions**
Be sure to store CDs in their cases to protect them from dust, scratches, and warping.
- Do not place or store CDs in the following places**
 - Locations exposed to direct sunlight
 - Humid or dusty locations
 - Locations directly exposed to a heat vent or heating appliance
 - In the glove compartment or on the rear deck of an automobile

Maintaining the Lens

Open the lid and clean the lens as shown in the figure.

Use a cotton swab to gently wipe off any finger-prints.

Recommended product:

Lens cleaner kit (SZZP1038C)

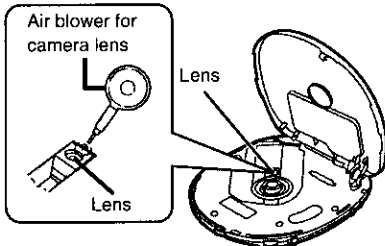

Product Service

Do not attempt to remove the cover(s) or repair the unit yourself. Refer servicing to qualified personnel only.

Product information

For product service, product information or assistance with product operation, refer to the servicenter directory.

User memo:

DATE OF PURCHASE _____
 DEALER NAME _____
 DEALER ADDRESS _____
 TELEPHONE NUMBER _____

CAUTION!

THIS PRODUCT UTILIZES A LASER.
USE OF CONTROLS OR ADJUSTMENTS OR PERFORMANCE OF PROCEDURES OTHER THAN THOSE SPECIFIED HEREIN MAY RESULT IN HAZARDOUS RADIATION EXPOSURE.
DO NOT OPEN COVERS- AND DO NOT REPAIR YOURSELF.
REFER SERVICING TO QUALIFIED PERSONNEL.

WARNING:

TO REDUCE THE RISK OF FIRE, ELECTRIC SHOCK OR PRODUCT DAMAGE, DO NOT EXPOSE THIS APPLIANCE TO RAIN, SPLASHING, DRIPPING OR MOISTURE.

THE FOLLOWING APPLIES ONLY IN THE U.S.A.:

CAUTION:

This equipment has been tested and found to comply with the limits for a Class B digital device, pursuant to Part 15 of the FCC Rules. These limits are designed to provide reasonable protection against harmful interference in a residential installation. This equipment generates, uses and can radiate radio frequency energy and, if not installed and used in accordance with the instructions, may cause harmful interference to radio communications. However, there is no guarantee that interference will not occur in a particular installation. If this equipment does cause harmful interference to radio or television reception, which can be determined by turning the equipment off and on, the user is encouraged to try to correct the interference by one of the following measures:

- Reorient or relocate the receiving antenna.
- Increase the separation between the equipment and receiver.
- Connect the equipment into an outlet on a circuit different from that to which the receiver is connected.
- Consult the dealer or an experienced radio/TV technician for help.

Any unauthorized changes or modifications to this equipment would void the user's authority to operate this device.

This device complies with Part 15 of the FCC Rules. Operation is subject to the following two conditions: (1) This device may not cause harmful interference, and (2) this device must accept any interference received, including interference that may cause undesired operation.

ONLY FOR U.S.A.

Panasonic Audio Products Limited Warranty

Panasonic Consumer Electronics Company, Division of Matsushita Electric Corporation of America
 One Panasonic Way,
 Secaucus, New Jersey 07094

Panasonic Sales Company, Division of Matsushita Electric Corporation of Puerto Rico, Inc.
 Ave. 65 de Infantería, Km. 9.5
 San Gabriel Industrial Park,
 Carolina, Puerto Rico 00985

Panasonic Consumer Electronics Company or Panasonic Sales Company (collectively referred to as "the warrantor") will repair this product with new or refurbished parts in the event of a defect in materials or workmanship, free of charge, in the U.S.A. or Puerto Rico as follows (all time periods start from the date of original purchase):

COMPACT DISC PLAYERS, RADIOS, VIDEO CD PLAYERS, RADIO CASSETTE PLAYERS/RECORDERS (with and without CD Players), CASSETTE RECORDERS, MICROCASSETTE RECORDERS/TRANSCRIBERS AND IC RECORDERS—labor and parts for one (1) year.

ACCESSORIES—HEADPHONES, CARTRIDGES, MICROPHONES, ADAPTERS—labor and parts for ninety (90) days.

BATTERIES—(when applicable)—New rechargeable batteries in exchange for defective rechargeable batteries for ten (10) days. Non-rechargeable batteries are not warranted.

RECHARGEABLE BATTERY PACKS—(when applicable)—New rechargeable battery packs in exchange for defective rechargeable battery packs for ninety (90) days. Non-rechargeable battery packs are not warranted.

Carry-in or mail-in service in the U.S.A. can be obtained during the warranty period by contacting a Panasonic Services Company (PASC) Factory Servicenter listed in the Servicenter Directory. Or call toll free, 1-800-211-7262 to locate a PASC authorized Servicenter. Carry-in or mail-in service in Puerto Rico can be obtained during the warranty period by calling the Panasonic Sales Company telephone number listed in the Servicenter Directory.

This warranty is extended only to the original purchaser. A purchase receipt or other proof of date of original purchase will be required before warranty service is rendered.

This warranty only covers failures due to defects in materials and workmanship

which occur during normal use and does not cover normal wear to the stylus (when applicable) or a dealer installed cartridge or stylus. The warranty does not cover damages which occur in shipment or failures which are caused by products not supplied by the warrantor, or failures which result from accident, misuse, abuse, neglect, mishandling, faulty installation, misapplication, set-up adjustments, maladjustment of consumer controls, improper operation or maintenance, improper antenna, inadequate signal reception or pick-up, alteration, modification, power line surge, improper voltage supply, lightning damage, commercial use, such as; hotel, office, restaurant, or other business or rental use of the product, or service by anyone other than a PASC Factory Servicenter or a PASC authorized Servicenter, or damage that is attributable to acts of God.

LIMITS AND EXCLUSIONS

There are no express warranties except as listed above.

THE WARRANTOR SHALL NOT BE LIABLE FOR INCIDENTAL OR CONSEQUENTIAL DAMAGES RESULTING FROM THE USE OF THIS PRODUCT, OR ARISING OUT OF ANY BREACH OF THIS WARRANTY, INCLUDING WITHOUT LIMITATION, DAMAGE TO TAPES, RECORDS OR DISCS. ALL EXPRESS AND IMPLIED WARRANTIES, INCLUDING THE WARRANTIES OF MERCHANTABILITY, AND FITNESS FOR A PARTICULAR PURPOSE, ARE LIMITED TO THE APPLICABLE WARRANTY PERIOD SET FORTH ABOVE. Some states do not allow the exclusion or limitation of incidental or consequential damages, or limitations on how long an implied warranty lasts, so the above exclusions or limitations may not apply to you.

This warranty gives you specific legal rights and you may also have other rights which vary from state to state.

If a problem with this product develops during or after the warranty period, you may contact your dealer or Servicenter. If the problem is not handled to your satisfaction, then write to the Panasonic Consumer Call Center at the company address above or call toll free 1-800-211-7262.

Specifications

Audio (ANTI-SHOCK off)

No. of channels: 2 (left and right, stereo)

Frequency response: 20 to 20,000 Hz (+0.5 dB to -1.5 dB)

Output voltage: 0.6 V (50 kΩ)
S/N: More than 96 dB*
Wow and flutter: Below measurable limit
DA converter: 1 bit, MASH
Headphone output level: Max. 9 mW+9 mW 16 Ω (adjustable)

Pickup

Light source: Semiconductor laser
Wavelength: 780 nm

General

Operational temperature range: 0 °C-40 °C (32 °F-104 °F)

Rechargeable temperature range: 5 °C-40 °C (41 °F-104 °F)

Power supply: DC 4.5 V
Power consumption:

Power source	Anti-shock off/on
Using AC adaptor	2.3 W/2.3 W

When recharging: About. 5.0 W

Play time:

[When used in hold mode with EQ cancelled, at 25 °C (77 °F), on a flat, stable surface].

Batteries used	Anti-shock OFF/ON
2 "AAA" (LR03) alkaline batteries	About 10 hours/ About 13 hours
2 "AA" (LR6) alkaline batteries	About 24 hours/ About 30 hours
Rechargeable batteries	About 6 hours/ About 8 hours
4 alkaline batteries	About 38 hours/ About 50 hours
2 rechargeable and 2 alkaline batteries	About 30 hours/ About 38 hours

The play time may be less depending on the operating conditions.

Recharging time: About 3 hours

Dimensions

(W×H×D): 128×20.7×131 mm
(5 1/16" × 1 3/16" × 5 3/16")
Mass: 188 g (6.6 oz.) (with batteries)
166 g (5.9 oz.) (without batteries)

*These specifications were measured in the ANTI-SHOCK off mode.

Power consumption in standby mode : 1.8 W

Note:

Specifications are subject to change without notice.

Mass and dimensions are approximate.

Troubleshooting Guide

Before requesting service for this unit, check the chart below for a possible cause of the problem you are experiencing. Some simple checks or a minor adjustment on your part may eliminate the problem and restore proper operation.

If you are in doubt about some of the check points, or if the remedies indicated in the chart do not solve the problem, refer to the directory of Authorized Service Centers (enclosed with this unit) to locate a convenient service center, or consult your dealer for instructions.

For detailed instructions, contact an authorized servicenter in the U.S.A. and Panasonic Canada Inc. Customer Care Centre in Canada. In the U.S.A. 1-800-211-7262 or web site (<http://www.panasonic.com>) in Canada 905-624-5505 or web site (www.panasonic.ca)

Problem	Check this
Cannot close the cover.	Is the disc properly secured in place?
Cannot play discs.	<ul style="list-style-type: none"> Is the unit in HOLD status? Is the disc properly secured in place? Is there moisture condensation on the lens? (Wait for about an hour and then try again.)
Cannot remove disc.	Did you press [PUSH] to release the disc?
Tracks on disc do not play in order, starting with the first track.	Is [RESUME, RANDOM, NORMAL] in the [NORMAL] position?
Cannot hear music—too noisy.	<ul style="list-style-type: none"> Have the headphone/earphone and wired remote control (SL-CT476J) plugs been inserted firmly? Are the plugs dirty? (Wipe away dirt on plug.) Separate the unit from mobile phones.
TV picture is distorted. Radio reception is noisy.	Are you using the unit body too near a TV or tuner? (If the TV or tuner is connected to a simple indoor antenna, connect it to an outdoor antenna.)

Cautions

Listening caution



Do not play your headphones or earphones at a high volume. Hearing experts advise against continuous extended play.

If you experience a ringing in your ears, reduce volume or discontinue use.

Do not use while operating a motorized vehicle. It may create a traffic hazard and is illegal in many areas.

You should use extreme caution or temporarily discontinue use in potentially hazardous situations.

Even if your headphones or earphones are the open-air type designed to let you hear outside sounds, don't turn up the volume so high that you can't hear what's around you.

Sound can be deceiving. Over time your hearing "comfort level" adapts to higher volumes of sound. So what sounds "normal" can actually be loud and harmful to your hearing.

Guard against this by setting your equipment at a safe level BEFORE your hearing adapts.

To establish a safe level:

- Start your volume control at a low setting.
- Slowly increase the sound until you can hear it comfortably and clearly, and without distortion.

Once you have established a comfortable sound level:

- Set the dial and leave it there.

Selection and care of rechargeable /dry cell batteries

Selection

As a safety precaution, the portable CD players made by Panasonic are constructed so it is impossible to recharge ordinary batteries.

Only batteries especially designed for this unit can be recharged.

Special nickel-metal hydride rechargeable batteries: HHR-4AHA/2B (set of 2)

For details, check with your dealer.

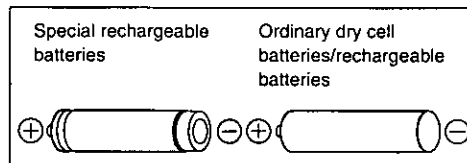

• If rechargeable battery play time is short after recharging, the batteries have reached the end of their service life. Replace them with the recommended replacements.

• Play time may be shorter than usual after recharging batteries for the first time or after they have been unused for a long time. Repeatedly recharge and discharge the batteries if this occurs to restore them to normal.

Care

To prevent battery damage, electrolyte leakage and short-circuiting, heed the following points.

- Do not peel off the covering on batteries and do not use if the covering has been peeled off.
- Align the poles ⊕ and ⊖ correctly when inserting the batteries.
- Do not mix different types or makes of batteries or old and new batteries.
- Remove the batteries if you do not intend to use the unit for a long time.
- Do not throw into fire, short-circuit, disassemble, or subject to excessive heat.
- Do not attempt to recharge dry cell batteries.
- Do not allow metal objects to touch the battery terminals as this may cause short-circuiting which is dangerous.
- When carrying batteries in a pocket or bag, ensure no metal objects such as necklaces are placed together with them. Contact with metal may cause short-circuiting which can cause a fire. For safety, carry the batteries in the battery carrying case.

When driving a car

In the interest of traffic safety, do not operate the unit while driving.