

OLYMPUS®

DIGITAL CAMERA

FE-120 X-700

Basic Manual

ENGLISH 2

FRANÇAIS 30

ESPAÑOL 58

PORTUGUÊS 86

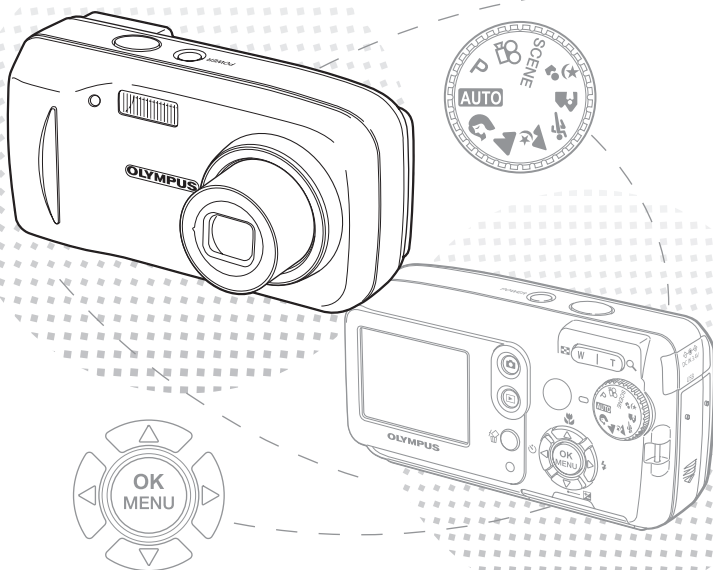

TABLE OF CONTENTS

CAMERA DIAGRAM	3
BEFORE YOU BEGIN	4
GETTING STARTED	5
Step 1 - GETTING STARTED	5
Step 2 - TAKE A PICTURE	6
Step 3 - REVIEW OR ERASE A PICTURE	7
Step 4 - TRANSFER IMAGES	8
BASIC OPERATION	10
Shooting tips	10
Power save feature	10
Mode dial	11
Shooting mode buttons	12
SCENE modes	13
Macro mode	13
Self timer	14
Flash modes	14
MENUS AND SETTINGS	15
Top menu	15
Erase all pictures	15
Select a language	16
Monitor symbols & icons	16
Thumbnail (Index) display	18
CONNECTING THE CAMERA	19
Direct printing (PictBridge)	19
OLYMPUS MASTER SOFTWARE	21
SPECIFICATIONS	22
SAFETY PRECAUTIONS	24

En

- Before using your camera, read this manual carefully to ensure correct use.
- We recommend that you take test shots to get accustomed to your camera before taking important photographs.
- Please observe the safety precautions at the end of this manual.

CAMERA DIAGRAM

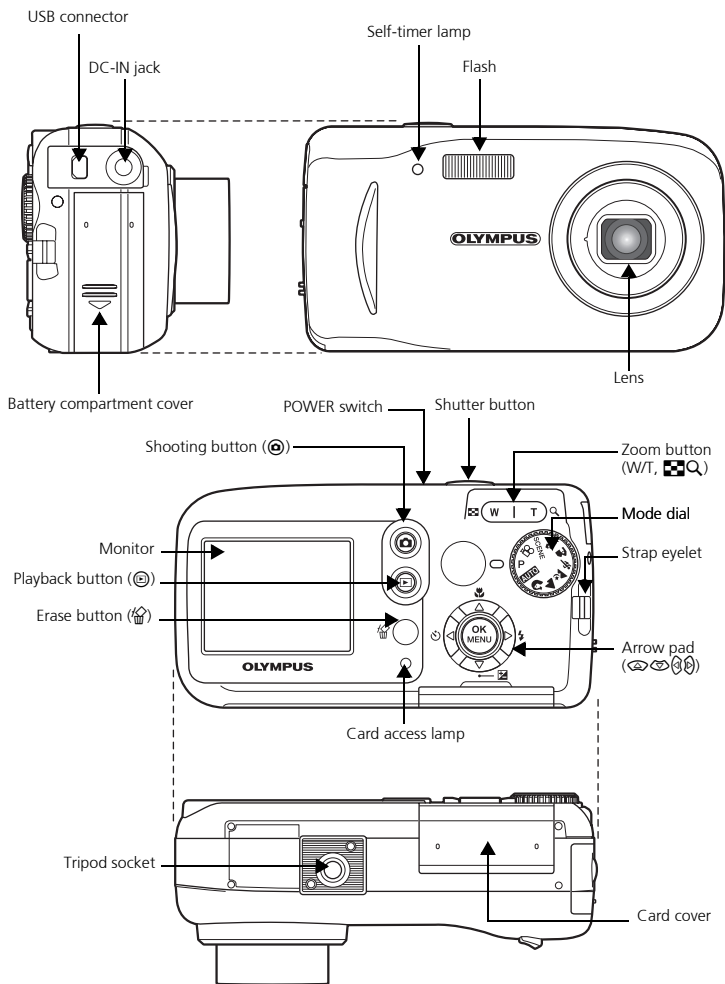

En

BEFORE YOU BEGIN

Gather these items (box contents)



Digital Camera



Strap



xD-Picture Card



AA (R6) Batteries (two)



USB Cable



OLYMPUS Master software
CD-ROM

This box also contains: Advanced Manual (CD-ROM), Basic Manual (this manual), Warranty card, Registration card. Contents may vary depending on purchase location.

1 GETTING STARTED

a. Attach the strap

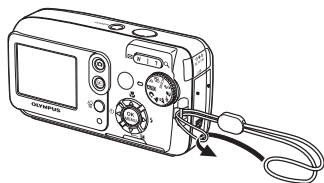

b. Insert the batteries

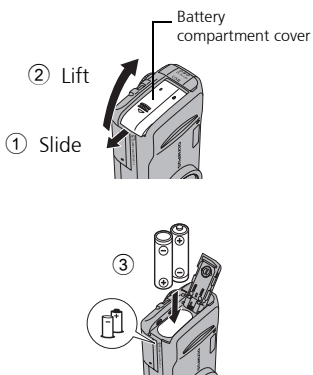

En

c. Set the date and time

- ① Set the mode dial to **AUTO** and turn the camera on. Then press button and select .

Mode dial



- ② Press to set item. Press to select next field.

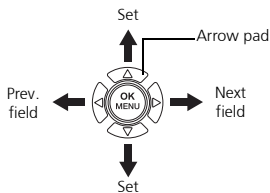
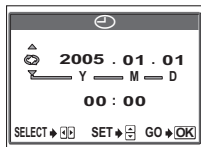

2 TAKE A PICTURE

En

a. Zoom

Zoom out:

or

Zoom in:

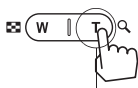
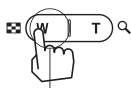

b. Focus

- ① Using the monitor, place the AF target mark over your subject.

Green lamp



AF target mark

(Half-pressed)



Shutter button

- ② Press and hold the shutter button halfway to lock focus. The green lamp indicates focus is locked.

c. Take the picture

Press the shutter button completely to take the picture.

(Pressed completely)



Shutter button





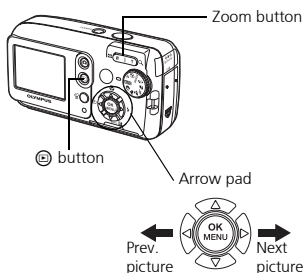

3 REVIEW OR ERASE A PICTURE

a. Press

The last picture taken will be displayed.



b. Take a closer look

Press    to zoom in or out.
Press   or   to scroll around.

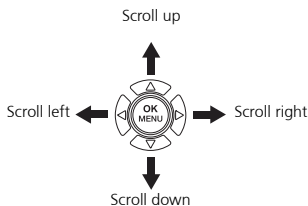



Press  button to return to shooting mode.

c. To erase a picture

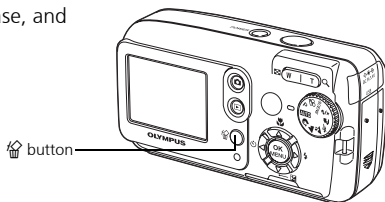
- 1 Display the picture you want to erase, and press the  button.



- 2 Press   to select [YES], and press  button.
The picture is permanently deleted.

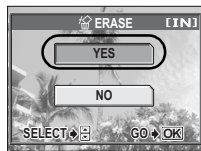

4 TRANSFER IMAGES

a. Install the software

En

- 1 Insert the OLYMPUS Master CD-ROM provided into the CD-ROM drive.
- 2 **Windows:** Click the "OLYMPUS Master" button.
Macintosh: Double-click the "Installer" icon.
- 3 Simply follow the on-screen instructions.



b. Connect the camera to the computer

- 1 Connect the camera and computer using the USB cable (included). The monitor will turn on automatically.

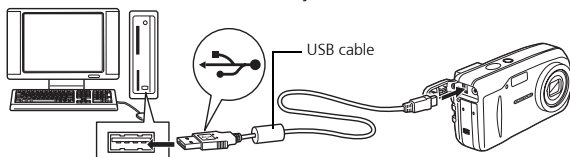

- 2 Press / to select [PC] and press the button.

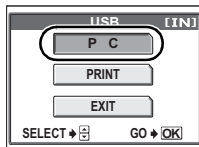

Your PC will now recognize your camera as a removable storage drive.

c. Transfer images to the computer

- ① With the camera now connected, open OLYMPUS Master.
The transfer window should appear.
- ② Select the images you want to transfer, and click the [TRANSFER IMAGES] button.

If the transfer images window does not automatically appear:

a. Click the "Transfer Images" icon.



b. Click the "From Camera" icon and then click [TRANSFER IMAGES].

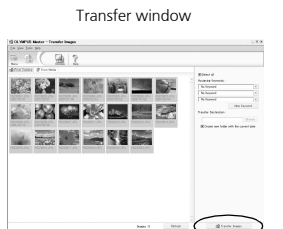

Transfer images
button

En

Note

For more details on using the OLYMPUS Master software, please refer to the (electronic) Reference Manual located in the OLYMPUS Master folder on your hard drive. Additionally, you may refer to the "Help" file in the OLYMPUS Master software.

BASIC OPERATION

Shooting tips

Pictures may appear blurred as the result of moving the camera while the shutter button is being pressed.

En

To prevent the camera from moving, hold the camera firmly with both hands while keeping your elbows at your sides. When taking pictures with the camera in the vertical position, hold the camera so that the flash is positioned above the lens. Keep your fingers and the strap away from the lens and flash.

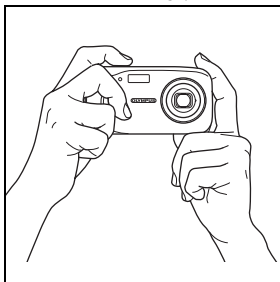

Horizontal grip

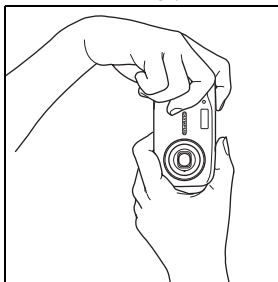

Vertical grip



Power save feature

To save battery power, the camera automatically enters to the sleep mode and stops operating if not used for 3 minutes. The monitor switches off automatically. Press the shutter button,  or  to turn the monitor on.





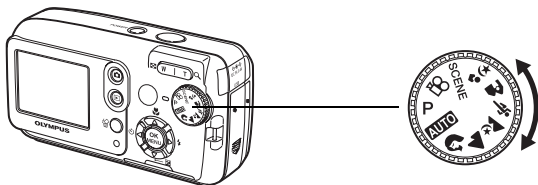

If the camera is not operated for 4 hours after the camera enters sleep mode, it automatically retracts the lens and turns off. To resume operation, turn on the power again.

Mode dial

This camera features a mode dial for selecting the camera's shooting mode. You may change shooting modes at any time.



En

P	Suitable for general situations.
AUTO	Takes pictures in full auto.
	Suitable for taking portrait-style pictures.
	Suitable for taking pictures of landscapes.
	Suitable for taking pictures at night.
	Suitable for taking moving subjects.
	Suitable for taking your subject in front of a landscape.
	Suitable for taking your subject in front of a night scene.
SCENE	This function allows you to select from 10 situation-related modes set to the shooting conditions.
	Records movies.

Shooting mode buttons

While in shooting mode, use these buttons for quick access to some of the more commonly used features.

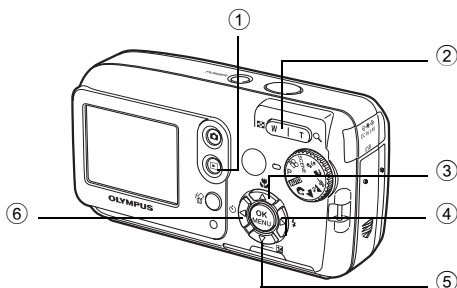

①  **(Playback) button**

Enables playback mode

② **Zoom button**

W: For wide-angle photography

T : For telephoto photography

③  **(Macro) button**

Enables macro mode or super macro mode

④  **(Flash mode) button**

For selecting the flash mode





⑤  **(Exposure compensation) button**

For making fine changes to the exposure setting

⑥  **(Self-timer) button**

Switches the self-timer mode on/off

SCENE modes

- 1 Set the mode dial to **SCENE** and press  and select [SCENE SELECT].
- 2 Press  or  to select a scene mode and press .

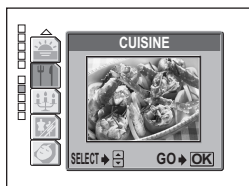









Scene mode descriptions



- SELF PORTRAIT
- INDOOR
- BEACH
- SNOW
- FIREWORKS
- SUNSET
- CUISINE
- CANDLE
- BEHIND GLASS
- AVAILABLE LIGHT PORTRAIT

En

Macro mode

-  This mode lets you shoot from as close as 20 cm/7.9" to your subject (when the optical zoom is at the greatest wide-angle).
 -  This mode lets you shoot from as close as 2 cm/0.8" to your subject. In the [] mode, normal shooting is also possible, but the position of the zoom is fixed automatically and cannot be adjusted.
- 1 Press  .
 - The macro settings screen is displayed.
- 2 Select [] or [], and press .





Self timer

- 1 Press 
 - The self-timer settings screen is displayed.
- 2 Select [ON], and press .
- 3 Press the shutter button fully to take the picture.
 - The self-timer lamp lights for approximately 10 seconds after the shutter button is pressed, then starts blinking. After blinking for approximately 2 seconds, the picture is taken.



En



Flash modes

- 1 Press 
 - The flash mode setting screen is displayed.
- 2 Press  to select the flash mode, and press .
- 3 Press the shutter button halfway.
 - When the flash is set to fire, the  mark lights steadily.
- 4 Press the shutter button fully to take the picture.

Flash working range:



W (max.) : Approx. 0.2 m to 3.7 m (0.7 ft. to 12.1 ft.)

T (max.) : Approx. 0.6 m to 2.1 m (2.0 ft. to 6.9 ft.)

Icon	Flash mode	Description
No indication	Auto flash	The flash fires automatically in low light or backlight conditions.
	Red-eye-reduction flash	The red-eye reduction flash mode significantly reduces this phenomenon by emitting pre-flashes before firing the regular flash.
	Fill-in flash	The flash fires regardless of the available light.
	Flash off	The flash does not fire even in low light conditions.

MENUS AND SETTINGS

Top menu

- 1 Press .
 - The top menu is displayed.
- 2 Use the arrow pad and  to navigate and select items.

Top menu in **P** mode

This refers to the arrow pad
()

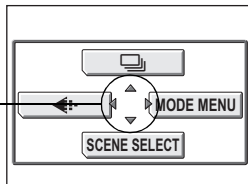

En

Image quality

Choose from several different image quality modes and resolutions.

Sequential shooting

Takes still pictures in succession. The focus, exposure, and white balance are locked at the first frame.



SCENE SELECT

This function allows you to select from 10 situation-related modes set to the shooting conditions.

MODE MENU

Contains language selection, start up options, date and time, format/erase.

Erase all pictures

- 1 While in playback mode, press  and select [MODE MENU] > [MEMORY (CARD)] > [ALL ERASE].
- 2 Select [YES], and press .
 - All the pictures are erased.

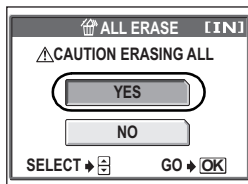

Select a language

You can select a language for on-screen display. Available languages vary depending on the area where you purchased this camera.

- 1 Press **OK MENU** and select [MODE MENU] > [SETUP] > [👤☰].
- 2 Select a language and press **OK MENU**.

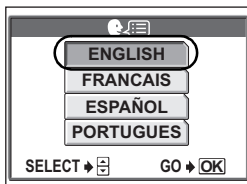

En

Monitor symbols & icons

Monitor - shooting mode

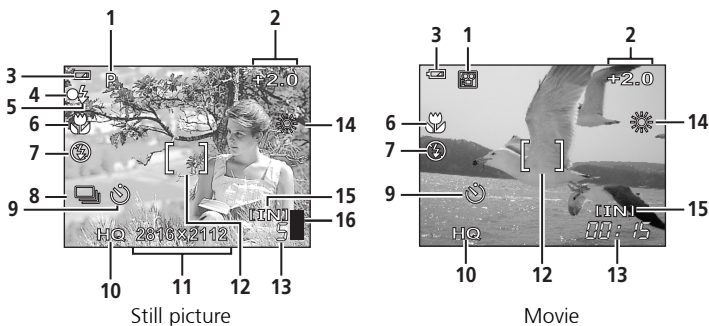

	Item	Indications
1	Shooting mode	P , AUTO , 📷, 📷, 📷, 📷, 📷, 📷, 📷
2	Exposure compensation	-2.0 – +2.0
3	Battery check	🔋 = full power, 🔋 = low power
4	Green lamp	○ = Auto Focus Lock

	Item	Indications
5	Flash stand-by Flash charge	⚡ (Lights) ⚡ (Blinks)
6	Macro mode Super macro mode	🌿 S🌿
7	Flash mode	👁️, ⚡, 🔋
8	Sequential shooting	📄
9	Self-timer	🕒
10	Record mode	SHQ, HQ, SQ1, SQ2, SQ
11	Image size	2816 × 2112, 1600 × 1200, 640 × 480
12	AF target mark	[]
13	Number of storable still pictures Remaining recording time	5 00:15
14	White balance	☀️, ☁️, 🌙, 🏠
15	Memory	[IN] (internal memory), [xD] (card)
16	Memory gauge	■, ■, 📱, 📱 (cannot take pictures)

Monitor - playback mode



Still picture

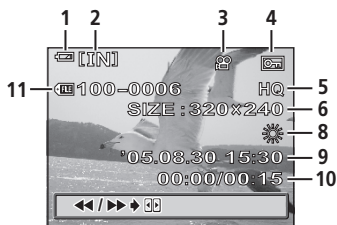

Movie

	Item	Indications
1	Battery check	= full power, = low power
2	Memory	[IN] (internal memory), [xD] (card)
3	Print reservation/ number of prints Movie	× 10
4	Protect	
5	Record mode	SHQ, HQ, SQ1, SQ2, SQ
6	Image size	2816 × 2112, 1600 × 1200, 640 × 480, 320 × 240
7	Exposure compensation	-2.0 – +2.0
8	White balance	WB AUTO, , , ,
9	Date and time	'05.08.30 15:30
10	Frame number Playing time/Total recording time	5 00:00/00:15
11	File number	100 – 0005

Thumbnail (Index) display

This function lets you show several pictures at the same time on the monitor.

When reviewing your images, press the zoom button toward W () to switch to the thumbnail (index) display.

- Use the arrow pad to select the picture.
- To return to the single-frame playback, press the zoom button toward T ().

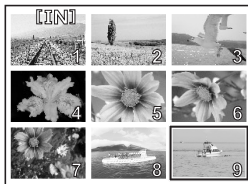

CONNECTING THE CAMERA

Direct printing (PictBridge)

Using the provided USB cable, you may connect your camera directly to a PictBridge compatible printer such as the Olympus P-11 to make prints.

- 1 Connect one end of the provided USB cable into the camera's USB connector and the other end into the printer's USB connector.

En

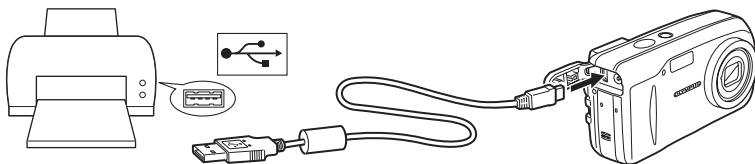

- 2 Select [PRINT] on the camera's monitor and press . After the [ONE MOMENT] screen closes, the camera and printer are connected.

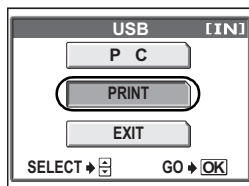

Direct printing (PictBridge) continued...

- 3 Use the arrow pad to select images and make prints.

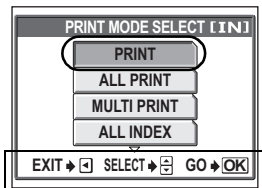

Follow the operation guide displayed here.

En

PRINT	Prints the selected picture.
ALL PRINT	Prints all the pictures stored in the internal memory or card.
MULTI PRINT	Prints one picture in multiple layout format.
ALL INDEX	Prints an index of all the pictures stored in the internal memory or card.
PRINT ORDER	Prints the pictures according to the print reservation data in the internal memory or card. If no print reservations have been made, this option is not available.

OLYMPUS MASTER SOFTWARE

OLYMPUS Master Software: Use this software to download pictures from the camera, view, organize, retouch, e-mail and print your digital photos and movies and more! This CD also contains the complete software User's Manual in Adobe Acrobat (PDF) format.



System requirements

OS	Windows 98SE/Me/2000Professional/XP or Mac OS X (10.2 or later)
CPU	Pentium III 500MHz / Power PC G3 500 MHz or later
RAM	128MB or more (at least 256MB is recommended)
Hard Disk	300MB or more
Connection	USB port
Monitor	Windows : 1,024 × 768 pixels, 65,536 colors or more Macintosh : 1,024 × 768 pixels, 32,000 colors or more

For the latest support information, visit the Olympus website (<http://www.olympus.com/digital>)



User Registration

Register your camera when you install OLYMPUS Master to activate your warranty, receive notifications of software and camera firmware updates, and more.

En

SPECIFICATIONS

Camera

Product type	: Digital camera (for shooting and displaying)
Recording system	
Still picture	: Digital recording, JPEG (in accordance with Design rule for Camera File system (DCF))
Applicable standards	: Exif 2.2, Digital Print Order Format (DPOF), PRINT Image Matching III, PictBridge
Movie	: QuickTime Motion JPEG support
Memory	: Internal memory xD-Picture Card (16 MB - 1 GB)
Image size	: 2,816 × 2,112 pixels (SHQ) 2,816 × 2,112 pixels (HQ) 1,600 × 1,200 pixels (SQ1) 640 × 480 pixels (SQ2)
No. of storable pictures (when using the 32 MB xD-Picture Card)	: Approx. 7 frames (SHQ) Approx. 21 frames (HQ) Approx. 64 frames (SQ1) Approx. 331 frames (SQ2)
No. of effective pixels	: Approx. 6,000,000 pixels
Image pickup device	: 1/2.5" CCD solid-state image pickup, 6,370,000 pixels (gross)
Lens	: Olympus lens 6.3 to 18.9 mm, f2.8 to 4.9 (equivalent to 38 to 114 mm on a 35 mm camera)
Photometric system	: Digital ESP metering
Shutter speed	: 4 to 1/2,000 sec.
Shooting range	: 0.5 m (1.6 ft.) to ∞ (W), 0.9 m (3.0 ft.) to ∞ (T) (normal) 0.2 m (0.7 ft.) to ∞ (W), 0.6 m (2.0 ft.) to ∞ (T) (macro mode)
Monitor	: 1.8" TFT color LCD display, 85,000 pixels
Auto focus	: Contrast Detection Method
Outer connector	: DC-IN jack, USB connector
Automatic calendar system	: 2005 up to 2099

Operating environment	
Temperature	: 0°C to 40°C (32°F to 104°F) (operation)/ -20°C to 60°C (-4°F to 140°F) (storage)
Humidity	: 30% to 90% (operation)/10% to 90% (storage)
Power supply	: Two AA (R6) Oxryde batteries, two alkaline batteries or two NiMH batteries/One lithium battery pack (CR-V3)/ Olympus AC adapter (optional)
Dimensions	: 106 mm (W) × 56 mm (H) × 36 mm (D) (4.2" × 2.2" × 1.4") excluding protrusions
Weight	: 140 g (0.3 lb.) without battery and card

Design and specifications subject to change without notice.

En

xD-Picture Card

Memory type	: NAND flash EEPROM
Operating environment	
Temperature	: 0°C to 55°C (32°F to 131°F) (operation)/ -20°C to 65°C (-4°F to 149°F) (storage)
Humidity	: 95% or lower
Power	: 3V (3.3V)
Dimensions	: 20 × 25 × 1.7 mm (0.8" × 1.0" × 0.1")

SAFETY PRECAUTIONS

En

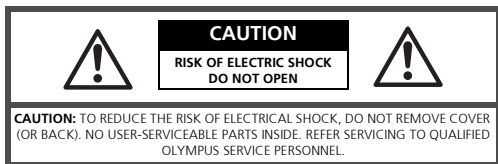

An exclamation mark enclosed in a triangle alerts you to important operating and maintenance instructions in the documentation provided with the product.



DANGER

If the product is used without observing the information given under this symbol, serious injury or death may result.



WARNINGS

If the product is used without observing the information given under this symbol, injury or death may result.



CAUTION

If the product is used without observing the information given under this symbol, minor personal injury, damage to the equipment, or loss of valuable data may result.

WARNING!

TO AVOID THE RISK OF FIRE OR ELECTRICAL SHOCK, NEVER DISASSEMBLE EXPOSE THIS PRODUCT TO WATER OR OPERATE IN A HIGH HUMIDITY ENVIRONMENT.

General Precautions

Read All Instructions — Before you use the product, read all operating instructions. Save all manuals and documentation for future reference.

Cleaning — Always unplug this product from the wall outlet before cleaning. Use only a damp cloth for cleaning. Never use any type of liquid or aerosol cleaner, or any type of organic solvent to clean this product.

Attachments — For your safety, and to avoid damaging the product, use only accessories recommended by Olympus.

Water and Moisture — For precautions on products with weatherproof designs, read the weatherproofing sections.

Location — To avoid damage to the product mount the product securely on a stable tripod, stand, or bracket.

Power Source — Connect this product only to the power source described on the product label.

Lightning — If a lightning storm occurs while using an AC adapter, remove it from the wall outlet immediately.

Foreign Objects — To avoid personal injury, never insert a metal object into the product.

Heat — Never use or store this product near any heat source such as a radiator, heat register, stove, or any type of equipment or appliance that generates heat, including stereo amplifiers.

Handling the Camera



WARNING

- **Do not use the camera near flammable or explosive gases.**
- **Do not use the flash on people (infants, small children, etc.) at close range.**
 - You must be at least 1 m (3 ft.) away from the faces of your subjects. Firing the flash too close to the subject's eyes could cause a momentary loss of vision.
- **Keep young children and infants away from the camera.**
 - Always use and store the camera out of the reach of young children and infants to prevent the following dangerous situations which could cause serious injury:
 - Becoming entangled in the camera strap, causing strangulation.
 - Accidentally swallowing the battery, cards or other small parts.
 - Accidentally firing the flash into their own eyes or those of another child.
 - Accidentally being injured by the moving parts of the camera.
- **Do not look at the sun or strong lights with the camera.**
- **Do not use or store the camera in dusty or humid places.**
- **Do not cover the flash with a hand while firing.**



CAUTION

- **Stop using the camera immediately if you notice any unusual odors, noise, or smoke around it.**
 - Never remove the batteries with bare hands, which may cause a fire or burn your hands.
- **Never hold or operate the camera with wet hands.**
- **Do not leave the camera in places where it may be subject to extremely high temperatures.**
 - Doing so may cause parts to deteriorate and, in some circumstances, cause the camera to catch fire. Do not use the charger or AC adapter if it is covered (such as a blanket). This could cause overheating, resulting in fire.
- **Handle the camera with care to avoid getting a low-temperature burn.**
 - When the camera contains metal parts, overheating can result in a low-temperature burn. Pay attention to the following:
 - When used for a long period, the camera will get hot. If you hold on to the camera in this state, a low-temperature burn may be caused.
 - In places subject to extremely cold temperatures, the temperature of the camera's body may be lower than the environmental temperature. If possible, wear gloves when handling the camera in cold temperatures.
- **Be careful with the strap.**
 - Be careful with the strap when you carry the camera. It could easily catch on stray objects – and cause serious damage.

Battery handling precautions

Follow these important guidelines to prevent batteries from leaking, overheating, burning, exploding, or causing electrical shocks or burns.



DANGER

- Use only the Olympus brand NiMH batteries and fitting charger.
- Never heat or incinerate batteries.
- Take precautions when carrying or storing batteries to prevent them from coming into contact with any metal objects such as jewelry, pins, fasteners, etc.
- Never store batteries where they will be exposed to direct sunlight, or subjected to high temperatures in a hot vehicle, near a heat source, etc.
- To prevent causing battery leaks or damaging their terminals, carefully follow all instructions regarding the use of batteries. Never attempt to disassemble a battery or modify it in any way, by soldering, etc.
- If battery fluid gets into your eyes, flush your eyes immediately with clear, cold running water and seek medical attention immediately.
- Always store batteries out of the reach of small children. If a child accidentally swallows a battery, seek medical attention immediately.



WARNING

- Keep batteries dry at all times.
- To prevent batteries from leaking, overheating, or causing a fire or explosion, use only batteries recommended for use with this product.
- Never mix batteries (old and new batteries, charged and uncharged batteries, batteries of different manufacture or capacity, etc.).
- Never attempt to charge alkaline, lithium or CR-V3 lithium battery packs.
- Insert the battery carefully as described in the operating instructions.
- Do not use batteries if their body is not covered by the insulating sheet or if the sheet is torn, as this may cause fluid leaks, fire, or injury.



CAUTION

- Do not remove batteries immediately after using the camera. Batteries may become hot during prolonged use.
- Always unload the battery from the camera before storing the camera for a long period.

• The following AA (R6) batteries cannot be used.

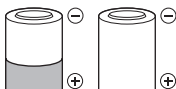

Batteries whose bodies are only partially or not at all covered by an insulating sheet.



Batteries whose \ominus terminals are raised, but not covered by an insulating sheet.

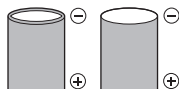

Batteries whose terminals are flat and not completely covered by an insulating sheet. (Such batteries cannot be used even if the \ominus terminals are partially covered.)

- If NiMH batteries are not charged within the specified time, stop charging them and do not use them.
- Do not use a battery if it is cracked or broken.
- If a battery leaks, becomes discolored or deformed, or becomes abnormal in any other way during operation, stop using the camera.
- If a battery leaks fluid onto your clothing or skin, remove the clothing and flush the affected area with clean, running cold water immediately. If the fluid burns your skin, seek medical attention immediately.
- Never subject batteries to strong shocks or continuous vibration.

En

For customers in North and South America

For customers in USA

Declaration of Conformity

Model Number : FE-120/X-700

Trade Name : OLYMPUS

Responsible Party : **OLYMPUS IMAGING AMERICA INC.**

Address : Two Corporate Center Drive, P.O. Box 9058, Melville, NY
11747-9058 U.S.A.

Telephone Number : 1-631-844-5000

Tested To Comply With FCC Standards

FOR HOME OR OFFICE USE

This device complies with Part 15 of the FCC rules. Operation is subject to the following two conditions:

- (1) This device may not cause harmful interference.
- (2) This device must accept any interference received, including interference that may cause undesired operation.

For customers in Canada

This Class B digital apparatus meets all requirements of the Canadian Interference-Causing Equipment Regulations.

En

Trademarks

- IBM is a registered trademark of International Business Machines Corporation.
- Microsoft and Windows are registered trademarks of Microsoft Corporation.
- Macintosh is a trademark of Apple Computer Inc.
- xD-Picture Card™ is a trademark.
- All other company and product names are registered trademarks and/or trademarks of their respective owners.
- The standards for camera file systems referred to in this manual are the "Design Rule for Camera File System/DCF" standards stipulated by the Japan Electronics and Information Technology Industries Association (JEITA).

MEMO

SOMMAIRE

L'APPAREIL EN ILLUSTRATIONS	31
AVANT DE COMMENCER.....	32
MISE EN ROUTE.....	33
Étape 1 - MISE EN ROUTE	33
Étape 2 - PRENDRE UNE PHOTO	34
Étape 3 - VÉRIFIER OU EFFACER UNE PHOTO	35
Étape 4 - TRANSFERT D'IMAGES	36
FONCTIONNEMENT DE BASE	38
Conseils pour la prise de vues	38
Fonctionnalité économie d'énergie	38
Molette mode	39
Touches du mode prise de vue	40
Modes résultat	41
Mode gros plan	41
Retardateur	42
Modes flash	42
MENUS AND RÉLAGES.....	43
Menu supérieur	43
Effacez toutes les photos	43
Sélection de la langue	44
Symboles et icônes de l'écran	44
Affichage miniature (Index)	46
CONNEXION DE L'APPAREIL PHOTO	47
Impression directe (PictBridge)	47
LOGICIEL OLYMPUS MASTER.....	49
CARACTÉRISTIQUES.....	50
PRÉCAUTIONS DE SÉCURITÉ.....	52

- Avant d'utiliser votre appareil photo pour la première fois, veuillez lire attentivement ce manuel.
- Nous vous conseillons de vous habituer à votre appareil en prenant des photos de test avant de prendre des photos importantes.
- Veuillez respecter les précautions de sécurité indiquées à la fin de ce manuel.

L'APPAREIL EN ILLUSTRATIONS

Fr

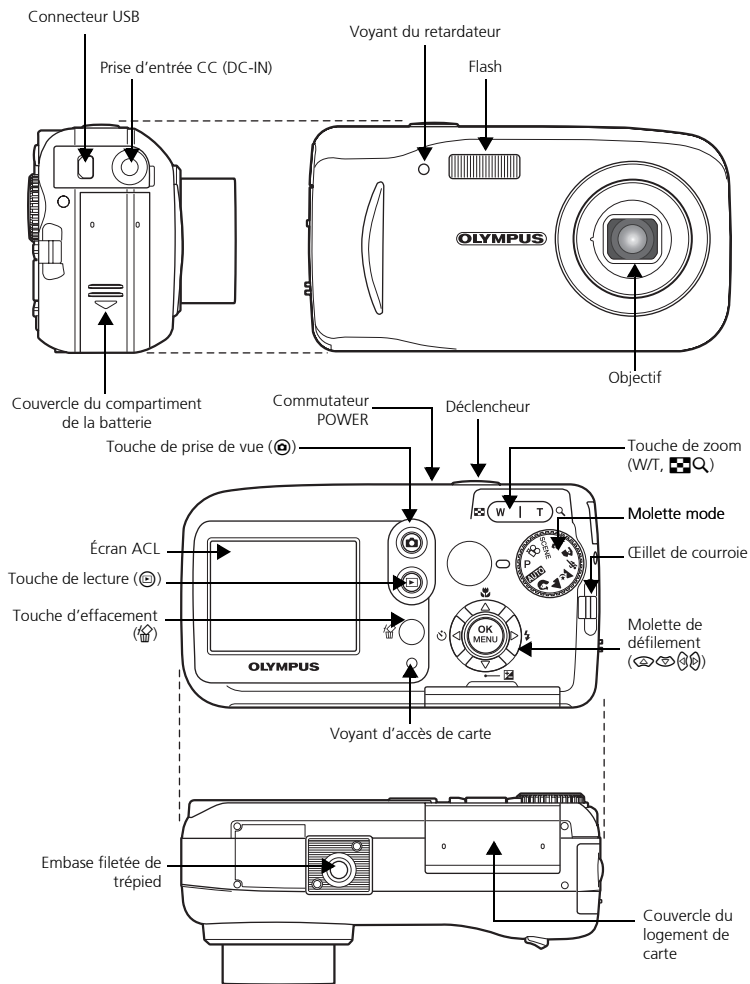

AVANT DE COMMENCER

Regroupez ces éléments (inclus dans l'emballage)



Appareil photo numérique



Courroie



xD-Picture Card



Deux piles AA (R6)



Câble USB



CD-ROM Logiciel OLYMPUS
Master

Cet emballage contient également : Un Manuel avancé (CD-ROM), un Manuel de base (ce manuel), une carte de garantie, une carte d'enregistrement. Le contenu peut varier selon le lieu où l'appareil a été acheté.

1 MISE EN ROUTE

a. Attachez la courroie

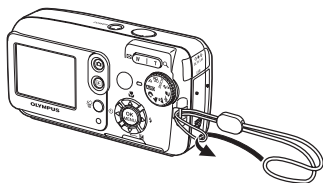

b. Insérez les piles.

- 1 Faites coulisser
 - 2 Soulevez
- Couvercle du compartiment des piles

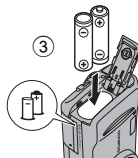

c. Réglez la date et l'heure.

- 1 Réglez la molette mode sur **AUTO** et allumez l'appareil. Appuyez ensuite sur la touche **OK** et sélectionnez

Molette mode



- 2 Appuyez sur / pour régler l'élément. Appuyez sur / pour sélectionner le champ suivant.

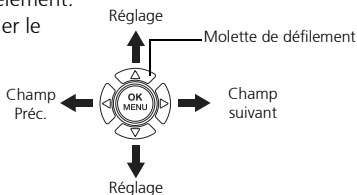
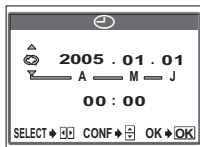

2 PRENDRE UNE PHOTO

a. Zoom

Zoom arrière : **OU** Zoom avant :

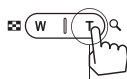
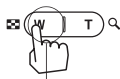

b. Mise au point

- 1 Placez le repère de mise au point sur votre sujet à l'aide de l'écran.

Voyant vert



(Mi-pression)



Repère de mise au point automatique

- 2 Appuyez et maintenez légèrement enfoncé le déclencheur pour mémoriser la mise au point. Le voyant vert indique que la mise au point est mémorisée.

c. Prenez la photo.

Enfoncez complètement le déclencheur pour prendre la photo.

(Appuyez à fond)



Déclencheur

3 VÉRIFIER OU EFFACER UNE PHOTO

a. Appuyez sur

La dernière photo prise s'affiche.

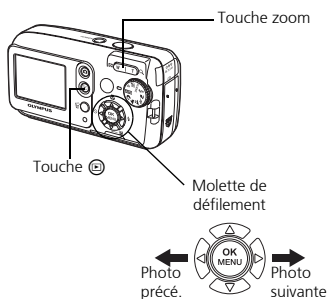

b. Vérifiez

Appuyez sur  pour faire un zoom avant ou arrière.

Appuyez sur / ou / pour faire défiler.

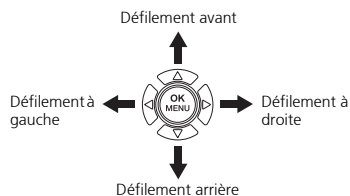



Appuyez sur  pour revenir au mode prise de vue.

c. Effacer une photo

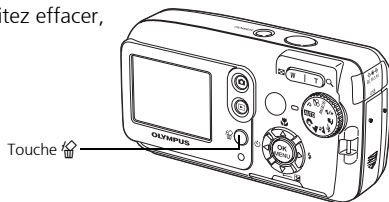
- 1 Affichez la photo que vous souhaitez effacer, puis appuyez sur la touche .



- 2 Appuyez sur / pour sélectionner [OUI], et appuyez sur la touche .
- La photo est définitivement effacée.



4 TRANSFERT D'IMAGES

a. Installez le logiciel

- 1 Insérez le CD-ROM OLYMPUS Master fourni dans le lecteur de CD-ROM.
- 2 **Windows:** Cliquez sur la touche "OLYMPUS Master".
Macintosh: Double-cliquez sur l'icône "Installer".
- 3 Suivez simplement les instructions sur l'écran.



Fr

b. Connectez l'appareil à l'ordinateur

- 1 Connectez l'appareil photo à l'ordinateur à l'aide du câble USB (fourni). L'écran s'allume automatiquement.

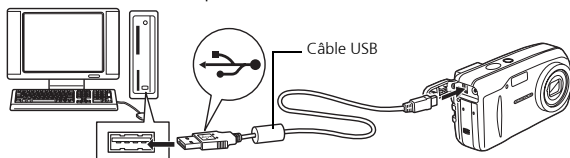

- 2 Appuyez sur / pour sélectionner [PC] et appuyez sur la touche .

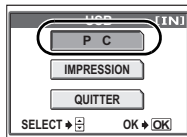

Votre ordinateur reconnaît votre appareil photo comme lecteur de stockage amovible

c. Transfert d'images vers un ordinateur

- ① L'appareil étant à présent connecté, ouvrez OLYMPUS Master.
La fenêtre de transfert doit s'afficher.

- ② Sélectionnez les images à transférer et cliquez sur la touche [Transférer des images].

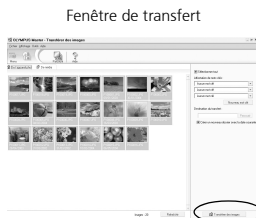

Si la fenêtre de transfert d'images n'apparaît pas automatiquement :

- a. Cliquez sur l'icône "Transférer des images".
- b. Cliquez sur l'icône "De l'appareil photo" et ensuite sur [Transférer des images].



Touche transférer des images

Fr

Remarque

Pour de plus amples détails sur l'utilisation du logiciel OLYMPUS Master, veuillez vous référer au manuel de référence (en ligne) situé dans le dossier OLYMPUS Master de votre disque dur. Vous pouvez aussi consulter le fichier "Aide" du logiciel OLYMPUS.

FONCTIONNEMENT DE BASE

Conseils pour la prise de vues

Les photos risquent d'être floues si l'appareil bouge au moment où vous appuyez sur le déclencheur.

Pour empêcher tout mouvement de l'appareil photo, tenez-le fermement avec les deux mains tout en appuyant les coudes le long du corps pour éviter de bouger. Lorsque vous prenez des photos en tenant l'appareil photo dans la position verticale, tenez-le de telle sorte que le flash soit au-dessus de l'objectif. Prenez garde à ce que vos doigts ou la courroie ne se trouvent pas devant l'objectif ou le flash.

Fr

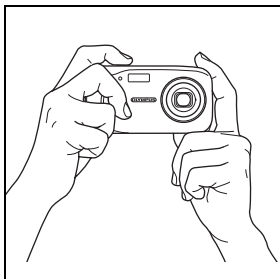

Position horizontale

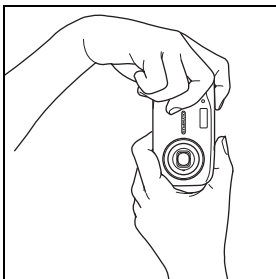

Position verticale



Fonctionnalité économie d'énergie





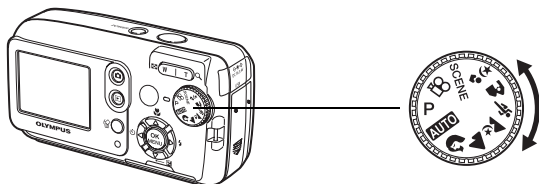

Pour économiser de l'énergie, l'appareil photo se met automatiquement en mode veille si pendant trois minutes il n'est pas utilisé. L'écran s'éteint automatiquement. Appuyez sur le déclencheur, sur  ou  pour allumer l'écran.

Si l'appareil n'est pas utilisé pendant un délai de 4 heures après sa mise en veille, l'objectif se rétracte automatiquement et l'appareil s'éteint. Pour reprendre le fonctionnement, remettez l'appareil sous tension.

Molette mode

Cet appareil photo possède une molette de mode qui permet de sélectionner le mode prise de vue de l'appareil photo. Vous pouvez, à tout moment, passer d'un mode de prise de vue à l'autre.



P	Adapté aux situations générales.
AUTO	Prend les photos en automatique intégral.
	Adapté aux photos de type portrait.
	Photos de paysages.
	Photos de nuit.
	Sujets en mouvement.
	Lorsque le sujet est devant un paysage.
	Lorsque le sujet est devant une scène nocturne.
SCENE	Cette fonction vous permet de sélectionner un mode parmi 10 en fonction des conditions de prises de vue.
	Enregistre des vidéos.

Fr

Touches du mode prise de vue

En mode prise de vue, utilisez ces touches pour un accès rapide à des fonctionnalités fréquemment utilisées.

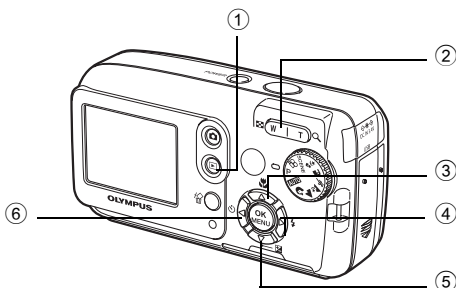



- ① **⏪ Touche de lecture**
Active le mode de lecture
- ② **Touche Zoom**
W : Pour des photos grand angle
T : Pour des photos au téléobjectif
- ③ **🔍 Touche Gros plan**
Active le mode gros plan ou super gros plan
- ④ **⚡ Touche Mode flash**
Permet de sélectionner le mode flash
- ⑤ **⊕/⊖ Touche Compensation d'exposition**
Permet d'affiner le réglage d'exposition
- ⑥ **🕒 Touche Retardateur**
Active/désactive le retardateur

Modes résultat

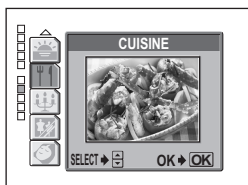
- 1 Réglez la molette mode sur **SCENE** et appuyez sur  et sélectionnez [SELECTION DE SCENE].











- 2 Appuyez sur  ou  pour sélectionner un mode résultat, et appuyez sur .

Fr



Descriptions du mode résultat

- AUTO PORTRAIT
- INTÉRIEUR
- PLAGE
- NEIGE
- FEUX D'ARTIFICES
- COUCHER DE SOLEIL
- CUISINE
- BOUGIE
- VITRINE
- NATUREL

Mode gros plan

-  Ce mode vous permet de prendre des photos à une distance de 20 cm de votre sujet (quand le zoom optique est à son plus grand angle).
 -  Ce mode vous permet de prendre des photos à une distance de 2 cm de votre sujet. En mode [], une prise de vue normale est également possible, mais la position du zoom est automatiquement fixée et ne peut être réglée.
- 1 Appuyez sur  .
 - L'écran des réglages du gros plan s'affiche.
 - 2 Sélectionnez [] ou [], puis appuyez sur .





Retardateur



- 1 Appuyez sur .
 - L'écran des réglages du retardateur s'affiche.
- 2 Sélectionnez [ACTIVE] puis appuyez sur .
- 3 Enfoncez complètement le déclencheur pour prendre la photo.
 - Le voyant du retardateur s'allume pendant 10 secondes environ après avoir enfoncé le déclencheur puis il commence à clignoter. La photo est prise après 2 secondes environ de clignotement.



Fr



Modes flash

- 1 Appuyez sur .
 - L'écran de réglage du mode flash s'affiche.
- 2 Appuyez sur  pour sélectionner un mode flash, et appuyez sur .
- 3 Enfoncez le déclencheur jusqu'à mi-course.
 - Quand le flash est réglé, le voyant  s'allume en continu.
- 4 Enfoncez complètement le déclencheur pour prendre la photo.
Plage de fonctionnement du flash :
W (max) : Environ 0,2 m à 3,7 m
T (max) : Environ 0,6 m à 2,1 m

Icône	Mode flash	Description
Aucune indication	Flash automatique	Le flash se déclenche automatiquement lorsque l'éclairage est faible ou en cas de contre-jour.
	Flash atténuant l'effet "yeux rouges"	Ce mode permet d'atténuer de manière significative l'effet "yeux rouges" en émettant une série de pré-éclairs avant de déclencher l'éclair principal.
	Flash d'appoint	Le flash se déclenche quelles que soient les conditions d'éclairage.
	Flash désactivé	Le flash ne se déclenche pas, même dans des situations de faible éclairage.



MENUS AND RÉLAGES

Menu supérieur

- 1 Appuyez sur .
 - Le menu s'affiche.
- 2 Utilisez la molette de défilement et  pour naviguer et sélectionner les éléments

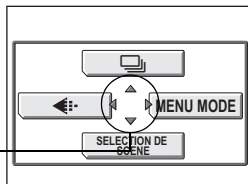
Menu supérieur en mode **P**



Se réfère à la molette de défilement (  ).

Mode d'enregistrement

Choisissez parmi différents modes de qualité d'image et de résolutions.

Prise de vue en série

Prend une succession de photos fixes en rafales. La mise au point, l'exposition et la balance des blancs sont mémorisées au premier cadrage.



SELECTION DE SCENE

Cette fonction vous permet de sélectionner un mode parmi 10 en fonction des conditions de prises de vue.

MENU MODE

Contient la sélection de langue, les options de démarrage, la date et l'heure ainsi que formater/effacer.

Effacez toutes les photos

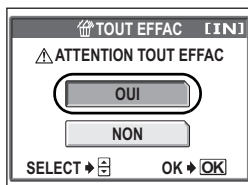

- 1 En mode prise de vue, appuyez sur  et sélectionnez [MENU MODE] > [MEMOIRE (CARTE)] > [TOUT EFFAC].
- 2 Sélectionnez [OUI] puis appuyez sur .
 - Toutes les photos sont effacées.



Fr

Sélection de la langue

Vous pouvez choisir la langue des messages affichés. Les langues disponibles dépendent de la région où vous avez acheté cet appareil photo.

- 1 Appuyez sur  et sélectionnez [MENU MODE] > [CONFIG] > .
- 2 Sélectionnez une langue, puis appuyez sur .

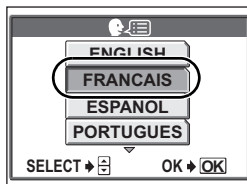







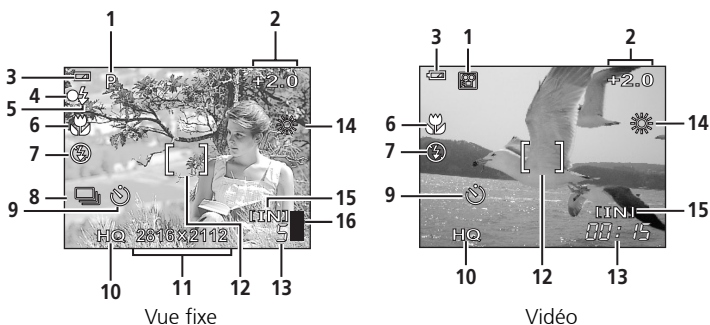

Fr

Symboles et icônes de l'écran

Écran – mode prise de vue



	Éléments	Indications
1	Mode prise de vue	P. AUTO ,  ,  ,  ,  ,  ,  , 
2	Compensation d'exposition	-2,0 – +2,0
3	Contrôle de la batterie	 = pleine puissance,  = puissance basse
4	Voyant vert	○ = Mémorisation de la mise au point automatique

	Éléments	Indications
5	Flash en attente Chargement du flash	⚡ (Voyants) ⚡ (Clignote)
6	Mode gros plan Mode super gros plan	🌿 S🌿
7	Mode flash	👁️, ⚡, 🔋
8	Prise de vue en série	📄
9	Retardateur	🕒
10	Mode d'enregistrement	SHQ, HQ, SQ1, SQ2, SQ
11	Taille d'image	2816 x 2112, 1600 x 1200, 640 x 480
12	Repère de mise au point automatique	[]
13	Nombre d'images fixes pouvant être stockées Durée d'enregistrement restante	5 00:15
14	Balance des blancs	☀️, ☁️, 🌧️, 🌑
15	Mémoire	[IN] (mémoire interne), [xD] (carte)
16	Bloc mémoire	🔋, 📱, 📱 (impossible de prendre des photos)

Fr

Écran – mode lecture



Vue fixe

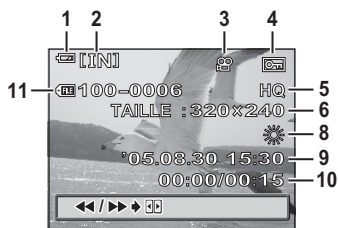

Vidéo

Écran – mode lecture suite...

	Éléments	Indications
1	Contrôle de la batterie	= pleine puissance, = puissance basse
2	Mémoire	[IN] (mémoire interne), [xD] (carte)
3	Réservation d'impression/ nombre d'impressions Vidéo	x10
4	Protection	
5	Mode d'enregistrement	SHQ, HQ, SQ1, SQ2, SQ
6	Taille d'image	2816 x 2112, 1600 x 1200, 640 x 480, 320 x 240
7	Compensation d'exposition	-2,0 – +2,0
8	Balance des blancs	WB AUTO, , , ,
9	Date et heure	'05.08.30 15:30
10	Numéro d'image Durée de lecture/durée d'enregistrement totale	5 00:00/00:15
11	Numéro de fichier	100 – 0005

Fr

Affichage miniature (Index)

Cette fonction vous permet de montrer plusieurs photos en même temps sur l'écran.

En revoyant vos photos, appuyez sur la touche zoom avant vers W () pour passer à l'affichage de miniatures (index).

- Utilisez la molette de défilement pour sélectionner une photo.
- Pour retourner à la lecture des photos une à une, appuyez sur la touche de zoom vers T ().

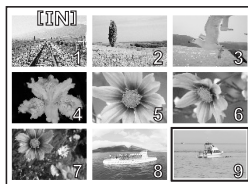

CONNEXION DE L'APPAREIL PHOTO

Impression directe (PictBridge)

A l'aide du câble USB fourni, vous pouvez connecter directement votre appareil sur une imprimante compatible Pictbridge comme par exemple l'Olympus P-11 pour imprimer vos photos.

- 1 Connectez une extrémité du câble USB fourni dans le connecteur USB de l'appareil photo et l'autre extrémité dans le connecteur USB de l'imprimante.

Fr

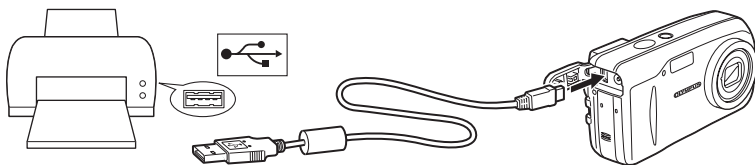

- 2 Sélectionnez [IMPRESSION] sur l'écran de l'appareil et appuyez sur .

Lorsque l'écran [UN MOMENT] s'éteint, l'appareil photo et l'imprimante sont connectés.

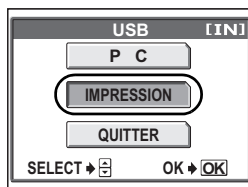

Impression directe (PictBridge) suite...

- Utilisez la molette de défilement pour sélectionner et imprimer les images.

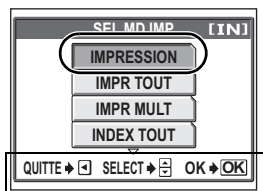

— Suivez le guide de fonctionnement affiché ici.

Fr

IMPRESSION
IMPR TOUT

Imprime la photo sélectionnée.

Imprime toutes les images de la mémoire interne ou de la carte.

IMPR MULT
INDEX TOUT

Imprime une photo avec différentes mises en page.

Imprime un index de toutes les images de la mémoire interne ou de la carte.

DEMANDE D'IMPRESSION

Imprime les photos selon les données de réservation d'impression contenues dans la mémoire interne ou la carte. Si aucune réservation d'impression n'a été faite, cette opération n'est pas disponible.

LOGICIEL OLYMPUS MASTER

Logiciel OLYMPUS Master : Utilisez ce logiciel pour télécharger les photos depuis l'appareil photo, afficher, organiser, retoucher, envoyer par e-mail et imprimer vos photos et vidéos numériques, et bien plus encore ! Ce CD contient également le guide de l'utilisateur complet du logiciel au format Adobe Acrobat (PDF).



Configurations système

Système d'exploitation	Windows 98SE/Me/2000Professional/XP ou Mac OS X (10.2 ou ultérieur)
Unité centrale	Pentium III 500MHz / Power PC G3 500 MHz ou ultérieur
Mémoire vive	128Mo ou plus (256Mo au moins recommandés)
Disque dur	300Mo ou plus
Connexion	Port USB
Écran ACL	Windows 1.024 × 768 pixels, 65.536 couleurs ou plus Macintosh : 1.024 × 768 pixels, 32.000 couleurs ou plus

Pour les dernières informations, voir le site web Olympus (<http://www.olympus.com/digital>)



Enregistrement de l'utilisateur

Enregistrez votre appareil photo en installant OLYMPUS Master pour activer la garantie, recevoir des mises à jour de logiciels et de matériels et bien plus encore.

CARACTÉRISTIQUES

Appareil photo

Type d'appareil	: Appareil photo numérique (prise de vue et affichage)
Système d'enregistrement	
Vue fixe	: Enregistrement numérique, JPEG (conformément au système DFC (Design rule for Camera File system))
Normes applicables	: Exif 2.2, Digital Print Order Format (DPOF), PRINT Image Matching III, PictBridge
Vidéo	: Prise en charge de QuickTime Motion JPEG
Mémoire	: Mémoire interne xD-Picture Card (16 Mo à 1 Go)
Taille d'image	: 2.816 × 2.112 pixels (SHQ) 2.816 × 2.112 pixels (HQ) 1.600 × 1.200 pixels (SQ1) 640 × 480 pixels (SQ2)
Nombre d'images enregistrables	
(lors de l'utilisation de la carte 32 Mo xD-Picture Card)	: Environ 7 images (SHQ) Environ 21 images (HQ) Environ 64 images (SQ1) Environ 331 images (SQ2)
Nombre de pixels effectifs:	Environ 6 000 000 pixels
Capteur d'image	: Capteur d'image CCD à semi-conducteur de 1/2,5 pouces à 6.370.000 de pixels (brut)
Objectif	: Objectif Olympus 6,3 à 18,9 mm, f2,8 à 4,9 (équivalent à un objectif de 38 à 114 mm sur un appareil photo 35 mm)
Système de mesure	: Mesure ESP numérique
Vitesse d'obturation	: 4 à 1/2.000 sec.
Portée de prise de vue	: 0,5 m à ∞ (W), 0,9 m à ∞ (T) (normal) 0,2 m à ∞ (W), 0,6 m à ∞ (T) (mode gros plan)
Écran ACL	: 1,8" Écran couleur à cristaux liquides TFT, 85.000 pixels
Mise au point automatique	: Méthode de détection de contraste
Connecteurs externes	: Prise d'entrée CC, connecteur USB
Calendrier automatique	: de 2005 à 2099

Conditions de fonctionnement

Température	: 0°C à 40°C (fonctionnement)/ -20°C à 60°C (stockage)
Humidité	: 30% à 90% (fonctionnement)/10% à 90% (stockage)
Alimentation	: Deux piles Oxyride, deux piles alcalines ou deux piles NiMH, toutes de type AA (R6)/ Un bloc-piles au lithium (CR-V3)/ Un adaptateur secteur Olympus (optionnel).
Dimensions	: 106 mm (L) x 56 mm (H) x 36 mm (P) hors saillies
Poids	: 140 g sans batterie ni carte

La conception et les caractéristiques peuvent être modifiées sans préavis.

xD-Picture Card

Fr

Type de mémoire	: Flash NAND EEPROM
Conditions de fonctionnement	
Température	: 0°C à 55°C (fonctionnement)/ -20°C à 65°C (stockage)
Humidité	: 95% ou moins
Alimentation	: 3V (3.3V)
Dimensions	: 20 x 25 x 1,7 mm

PRÉCAUTIONS DE SÉCURITÉ



ATTENTION

RISQUE DE DÉCHARGE
ÉLECTRIQUE
NE PAS OUVRIR



ATTENTION : POUR RÉDUIRE LE RISQUE DE DÉCHARGE ÉLECTRIQUE, NE PAS RETIRER LA PARTIE AVANT NI LE DOS DU BOÎTIER. AUCUNE PIÈCE À L'INTÉRIEUR NE PEUT ÊTRE RÉPARÉE PAR L'UTILISATEUR. SE RÉFÉRER À DU PERSONNEL DE DÉPANNAGE QUALIFIÉ POUR UNE RÉPARATION.

Fr



Le point d'exclamation à l'intérieur d'un triangle vous alerte sur certains points importants concernant le maniement et l'entretien de l'appareil figurant dans la documentation fournie avec le produit.



DANGER

Si le produit est utilisé sans respecter les informations données sous ce symbole, des blessures graves, voire mortelles pourraient en résulter.



AVERTISSEMENT

Si le produit est utilisé sans respecter les informations données sous ce symbole, des blessures voire la mort pourraient en résulter.



ATTENTION

Si le produit est utilisé sans observer les informations données sous ce symbole, des blessures, des dommages à l'appareil ou des pertes de données pourraient en résulter.

AVERTISSEMENT !

POUR ÉVITER LES RISQUES D'INCENDIE OU DE DÉCHARGE ÉLECTRIQUE, NE JAMAIS EXPOSER CE PRODUIT À L'EAU NI LE FAIRE FONCTIONNER DANS UN ENVIRONNEMENT TRÈS HUMIDE.

Précautions générales

Lire toutes les instructions — Avant d'utiliser l'appareil, lire toutes les instructions de fonctionnement. Conservez tous les manuels et la documentation pour pouvoir vous y référer ultérieurement.

Nettoyage — Toujours débrancher ce produit de la prise de courant avant nettoyage. N'utiliser qu'un chiffon humide pour le nettoyage. Ne jamais utiliser de produits de nettoyage liquides ou aérosols, ni de solvants organiques pour nettoyer ce produit.

Accessoires — Pour votre sécurité, et pour éviter d'endommager le produit, n'utiliser que des accessoires recommandés par Olympus.

Eau et humidité — Pour les précautions concernant les appareils manufacturés de manière à résister aux intempéries, lire les sections correspondantes.

Emplacement — Pour éviter de l'endommager, installez solidement l'appareil sur un trépied, un support ou une console stables.

Alimentation — Ne raccorder ce produit qu'à la source d'alimentation décrite sur l'étiquette du produit.

Foudre — Si un orage avec foudre se produit alors qu'un adaptateur secteur est utilisé, débranchez-le immédiatement de la prise murale.

Corps étrangers — Pour éviter toute blessure, n'insérez jamais de pièce métallique dans l'appareil.

Chaleur — Ne jamais utiliser ni ranger ce produit près d'une source de chaleur telle qu'un radiateur, un accumulateur de chaleur, ou tout type d'appareil qui génère de la chaleur, comprenant les amplificateurs.

Maniement de l'appareil



AVERTISSEMENT

- **Ne pas utiliser l'appareil à proximité de gaz inflammables ou explosifs.**
- **Ne pas utiliser le flash de très près sur des personnes (bébés, jeunes enfants, etc.).**
 - Vous devez être à une distance d'au moins 1 mètre du visage de vos sujets. Déclencher le flash trop près des yeux d'un sujet peut entraîner une perte de vision momentanée.
- **Ne pas laisser l'appareil à la portée des enfants.**
 - Toujours utiliser et ranger l'appareil hors de la portée des jeunes enfants et des bébés pour empêcher les situations dangereuses suivantes qui pourraient causer des blessures graves :
 - Devenir enroulé dans la courroie de l'appareil, causant la strangulation.
 - Avaler accidentellement la batterie, des cartes ou d'autres petites pièces.
 - Déclencher accidentellement le flash dans leurs yeux ou ceux d'un autre enfant.
 - Se blesser accidentellement par des parties en mouvement de l'appareil.
- **Ne pas regarder le soleil ni des lumières puissantes avec l'appareil.**
- **Ne pas utiliser ni ranger l'appareil dans des endroits poussiéreux ou humides.**
- **Ne pas couvrir le flash avec une main pendant le déclenchement.**



ATTENTION

- **Arrêter immédiatement d'utiliser l'appareil si vous remarquez une odeur, un bruit anormal ou de la fumée provenant de l'appareil.**
 - Ne jamais retirer les piles à mains nues, vous risquez un incendie ou de vous brûler les mains.
- **Ne jamais tenir ou utiliser l'appareil photos avec des mains mouillées.**
- **Ne pas laisser l'appareil dans des endroits où il pourrait être soumis à des températures très élevées.**
 - Ceci pourrait causer une détérioration de certaines pièces et, dans certaines circonstances, l'appareil pourrait prendre feu. Ne pas utiliser le chargeur ni un adaptateur secteur s'il est couvert (par exemple par une couverture). Ce qui pourrait causer une surchauffe, débouchant sur un incendie.

PRÉCAUTIONS DE SÉCURITÉ suite...

● Manipuler l'appareil soigneusement afin d'éviter une brûlure à basse température.

- Lorsque l'appareil contient des parties métalliques, une surchauffe peut déboucher sur une brûlure à basse température. Faire attention aux points suivants :
- Utilisé pendant une longue durée, l'appareil devient chaud. Si vous tenez l'appareil dans ces conditions, une brûlure à basse température risque de se produire.
- Dans des endroits sujets à des températures très froides, la température du corps de l'appareil peut être plus basse que la température ambiante. Si possible, mettre des gants en tenant l'appareil à des températures basses.

● Faire attention avec la courroie.

- Faire attention avec la courroie en portant l'appareil. Elle peut facilement s'accrocher à des objets sur le passage et causer des dommages sérieux.

Fr

Précautions de manipulation de la batterie

Veillez suivre ces consignes importantes pour éviter le coulage du liquide des batteries, une génération de chaleur, des brûlures, une explosion, ou causer des décharges électriques ou brûlures.



DANGER

- Utiliser uniquement des piles NiMH de marque Olympus et le chargeur correspondant.
- Ne jamais chauffer ni mettre au feu des piles.
- Prendre des précautions en transportant ou rangeant des piles pour éviter qu'elles viennent en contact avec des objets métalliques comme des bijoux, des épingles à cheveux, des agrafes, etc.
- Ne jamais ranger des piles où elles seraient exposées en plein soleil, ou sujettes à des températures élevées dans un véhicule chaud, près d'une source de chaleur, etc.
- Pour éviter de causer des coulages de liquide de pile ou d'endommager leurs bornes, respecter scrupuleusement toutes les instructions concernant l'usage des piles. Ne jamais tenter de démonter une pile ni la modifier, en soudant, etc.
- Si du liquide de pile entrait dans vos yeux, les laver immédiatement avec de l'eau claire et froide du robinet et consulter immédiatement un médecin.
- Toujours ranger les piles hors de la portée des jeunes enfants. Si un enfant avale accidentellement une pile, consulter immédiatement un médecin.

AVERTISSEMENT

- Maintenir à tout moment les piles au sec.
- Pour éviter un coulage du liquide des piles, une génération de chaleur ou de causer un incendie ou une explosion, n'utiliser que les piles recommandées pour l'utilisation avec ce produit.
- Ne jamais mélanger des piles/batteries (piles neuves et usagées, batteries chargées et déchargées, piles/batteries de fabricant ou de capacité différente, etc.).
- Ne jamais tenter de recharger des piles alcalines, lithium ni des batteries CR-V3 au lithium.
- Insérer soigneusement la pile comme indiqué dans les instructions de fonctionnement.
- Ne pas utiliser de piles dont le corps n'est pas recouvert d'une feuille isolante ou si la feuille est déchirée, cela pourrait causer une fuite de liquide, un incendie ou des blessures.

ATTENTION

- Ne pas retirer les piles immédiatement après avoir utilisé l'appareil photo. Les piles peuvent devenir chaudes lors d'une utilisation prolongée.
- Toujours retirer la batterie de l'appareil avant de le ranger pour une longue durée.

Fr

• Les piles AA suivantes ne peuvent pas être utilisées.

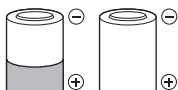

Piles dont le corps n'est que partiellement recouvert ou pas du tout recouvert par une feuille isolante.



Piles dont la borne \ominus est relevée, mais pas recouverte par une feuille isolante.

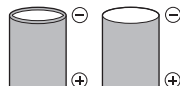

Piles dont les bornes sont plates et pas complètement recouvertes par une feuille isolante. (De telles piles ne peuvent pas être utilisées même si la borne \ominus est partiellement recouverte.)

- Si des piles NiMH ne sont pas chargées au bout de la durée spécifiée, arrêter de les charger et ne pas les utiliser.
- Ne pas utiliser une batterie si elle est endommagée ou cassée.
- Si une pile fuit, se décolore ou se déforme, ou présente tout autre aspect anormal, arrêter d'utiliser l'appareil photo.
- Si du liquide de pile coule sur vos vêtements ou sur votre peau, retirer le vêtement et laver immédiatement la zone affectée avec de l'eau claire et froide du robinet. Si le liquide vous brûle la peau, consulter immédiatement un médecin.
- Ne jamais soumettre les piles à des chocs violents ni à des vibrations continues.

Pour les utilisateurs d'Amérique du Nord et du Sud

Pour les utilisateurs aux États-Unis

Déclaration de conformité

Modèle numéro : FE-120/X-700

Marque : OLYMPUS

Organisme responsable : **OLYMPUS IMAGING AMERICA INC.**

Adresse : Two Corporate Center Drive, P.O. Box 9058, Melville,
NY 11747-9058 États-Unis

Numéro de téléphone : 1-631-844-5000

Testé pour être en conformité avec la réglementation FCC
POUR L'UTILISATION A LA MAISON OU AU BUREAU

Cet appareil est conforme aux normes de la Section 15 des directives FCC. Son utilisation est soumise aux deux conditions suivantes :

- (1) Cet appareil ne doit pas causer de brouillage radioélectrique.
- (2) Cet appareil doit pouvoir résister à toutes les interférences, y compris celles susceptibles d'entraver son bon fonctionnement.

Pour les utilisateurs au Canada

Cet appareil numérique de la catégorie B est conforme à la législation canadienne sur les appareils générateurs de parasites.

Fr

Marques déposées

- IBM est une marque déposée de la société International Business Machines Corporation.
- Microsoft et Windows sont des marques déposées de la société Microsoft Corporation.
- Macintosh est une marque de Apple Computer Inc.
- xD-Picture Card™ est une marque déposée.
- Tous les autres noms de sociétés et appellations de produits sont des marques, déposées ou non, des propriétaires respectifs.
- Les normes pour les systèmes de fichiers d'appareil photo indiquées dans ce manuel sont les normes "Design Rule for Camera File System/DCF" stipulées par l'association JEITA (Japan Electronics and Information Technology Industries Association).

MEMO

ÍNDICE DE MATERIAS

DIAGRAMA DE LA CÁMARA	59
ANTES DE EMPEZAR	60
PRIMEROS PASOS	61
Paso 1 - PRIMEROS PASOS	61
Paso 2 - TOME UNA FOTOGRAFÍA	62
Paso 3 - REVISE O BORRE LA FOTOGRAFÍA	63
Paso 4 - TRANSFERA IMÁGENES	64
UTILIZACIÓN BÁSICA	66
Consejos sobre fotografía.....	66
Características de ahorro de energía	66
Disco de modo	67
Botones del modo de fotografía	68
Modos de preselección de escena.....	69
Modo macro	69
Disparador automático	70
Modos de flash	70
MENÚS Y AJUSTES	71
Menú superior.....	71
Borrar todas las fotografías.....	71
Seleccione un idioma.....	72
Símbolos e iconos del monitor	72
Vista (Índice) de miniaturas	74
CONEXIÓN DE LA CÁMARA	75
Impresión directa (PictBridge).....	75
SOFTWARE OLYMPUS MASTER	77
ESPECIFICACIONES	78
PRECAUCIONES DE SEGURIDAD	80
■ Antes de utilizar la cámara, lea atentamente este manual para poder utilizarla correctamente.	
■ Antes de tomar fotografías importantes, le recomendamos que realice varias tomas de prueba para familiarizarse con el uso de su cámara.	
■ Siga las precauciones de seguridad que figuran al final de este manual.	

DIAGRAMA DE LA CÁMARA

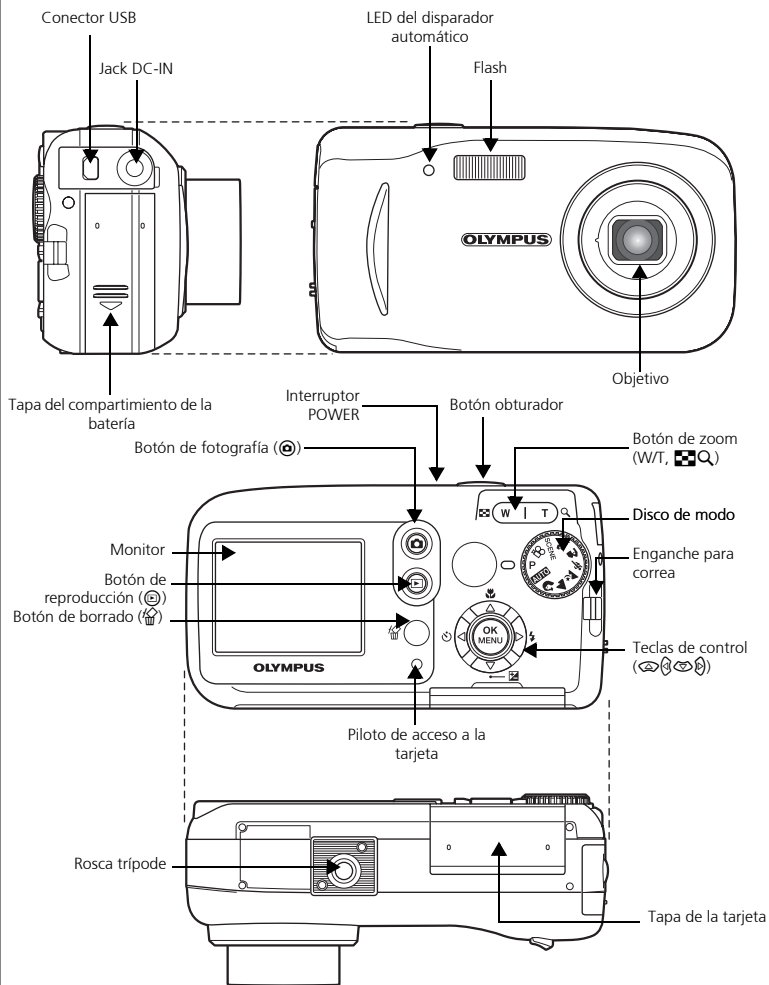

Es

ANTES DE EMPEZAR

Reúna estos componentes (contenido de la caja)



Cámara digital



Correa



xD-Picture Card



Pilas AA (R6) (dos)



Cable USB



CD-ROM del software
OLYMPUS Master

Es

Esta caja contiene además: Manual avanzado (CD-ROM), Manual básico (este manual), Tarjeta de garantía, Tarjeta de registro. El contenido puede variar según el lugar de compra.

1 PRIMEROS PASOS

a. Coloque la correa

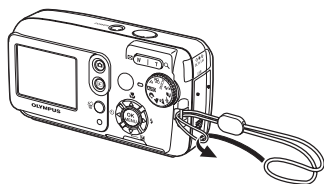

b. Inserte las pilas

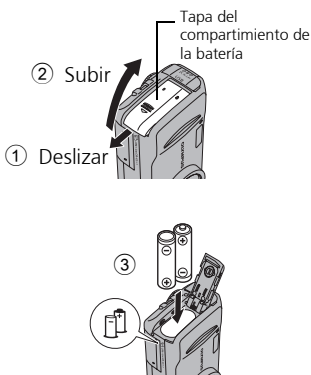





c. Ajuste la fecha y la hora

- ① Sitúe el disco de modo en **AUTO** y encienda la cámara. Luego presione el botón  y seleccione .

Disco de modo



- ② Presione  /  para configurar cada opción. Presione  /  para seleccionar el campo siguiente.

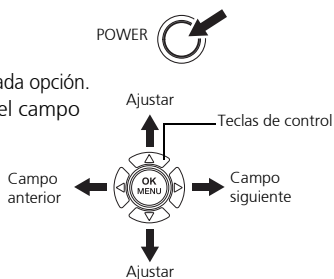
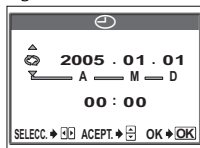

Es

2 TOME UNA FOTOGRAFÍA

a. Zoom

Zoom de alejamiento:



Zoom de acercamiento:

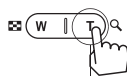

Es

b. Enfoque

- 1 Utilizando el monitor, sitúe la marca de objetivo de enfoque automático (AF) sobre el sujeto.

Piloto verde



Marca de objetivo de enfoque automático (AF)

(Presionado a medias)



Botón disparador

- 2 Mantenga presionado el botón disparador a medias para bloquear el enfoque. El piloto verde indica que el enfoque está bloqueado.

c. Haga la fotografía

Presione el botón disparador a fondo para tomar la fotografía.

(Presionado a fondo)



Botón disparador

3

REVISE O BORRE LA FOTOGRAFÍA

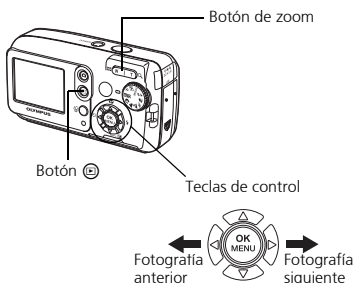

a. Presione

Aparecerá la última fotografía tomada.



b. Mire más de cerca

Presione  para acercarse o alejarse.

Presione  o  para desplazarse.

Desplazamiento arriba

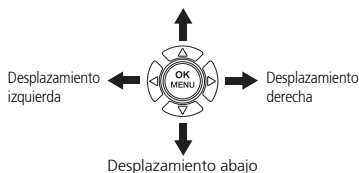



Presione el botón  para volver al modo de fotografía.

c. Para borrar una fotografía

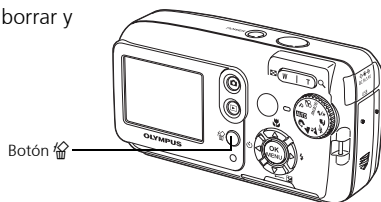
- 1 Seleccione la fotografía que desee borrar y presione el botón .



- 2 Presione  para seleccionar [SI], y presione el botón . La fotografía se borra para siempre.



Es

4 TRANSFIERA IMÁGENES

a. Instale el software



- 1 Inserte el CD-ROM de OLYMPUS Master suministrado en la unidad de CD-ROM.
- 2 **Windows:** Haga clic en "OLYMPUS Master".
Macintosh: Haga doble clic en el icono "Installer".
- 3 Siga las instrucciones en pantalla.

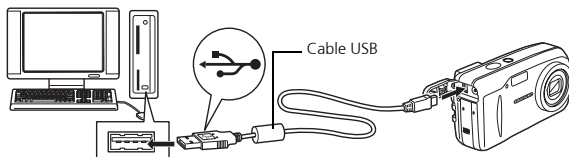

b. Conecte la cámara al ordenador

- 1 Conecte la cámara al ordenador usando el cable USB (incluido). El monitor se enciende automáticamente.



- 2 Presione  /  para seleccionar [PC] y presione el botón .

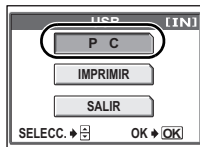

EL PC reconocerá la cámara como una unidad de almacenamiento extraíble.

c. Transfiera las imágenes al ordenador

- 1 Con la cámara ya conectada, abra OLYMPUS Master.
Debe aparecer la ventana de transferencia.

- 2 Seleccione las imágenes que desea transferir y haga clic en el botón [Transferir imágenes].

Si la ventana de transferencia de imágenes no aparece de forma automática:

- a. Haga clic en el icono "Transferir imágenes".
- b. Haga clic en el icono "De cámara" y luego haga clic en [Transferir imágenes].



Nota

Si desea información adicional sobre cómo utilizar el software OLYMPUS Master, consulte el Manual de referencia (electrónico) que encontrará en la carpeta OLYMPUS Master del disco duro. También puede consultar el archivo "Ayuda" del software OLYMPUS Master.

UTILIZACIÓN BÁSICA

Consejos sobre fotografía

Las imágenes pueden aparecer borrosas como resultado de mover la cámara mientras se presiona el botón disparador.

Para evitar que se mueva la cámara, sujétela con firmeza con ambas manos, apoyando los codos contra el cuerpo. Al hacer fotografías con la cámara en posición vertical, sujete la cámara de modo que el flash quede por encima del objetivo.

Mantenga los dedos y la correa alejados del objetivo y del flash.

Es

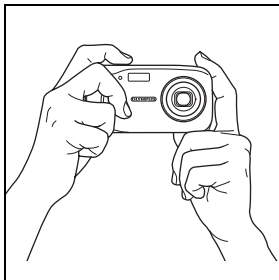

Sujeción horizontal

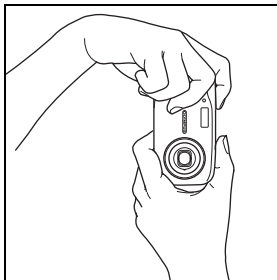

Sujeción vertical



Características de ahorro de energía





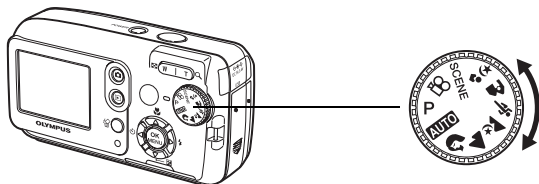

Para ahorrar energía, la cámara entra automáticamente en el modo de reposo y deja de funcionar si no se utiliza durante 3 minutos. El monitor se apaga automáticamente. Presione el botón disparador,  o  para encender el monitor.

Si la cámara no se utiliza durante 4 horas, después de haber entrado en el modo de reposo, automáticamente recoge el objetivo y se apaga. Para utilizarla de nuevo, vuelva a encenderla.

Disco de modo

Esta cámara cuenta con un disco de modo para seleccionar el modo de fotografía de la cámara. Los modos de fotografía se pueden cambiar en cualquier momento.



P	Apropiado para situaciones generales.
AUTO	Hace las fotografías de modo totalmente automático.
	Apropiado para hacer fotografías estilo retrato.
	Apropiado para fotografiar paisajes.
	Apropiado para fotografiar de noche.
	Apropiado para fotografiar sujetos en movimiento.
	Apropiado para fotografiar al sujeto delante de un paisaje.
	Apropiado para fotografiar al sujeto delante de una escena nocturna.
SCENE	Esta función le permite seleccionar entre 10 modos de situación configurados según las condiciones de fotografía.
	Sirve para grabar vídeos.

Es

Botones del modo de fotografía



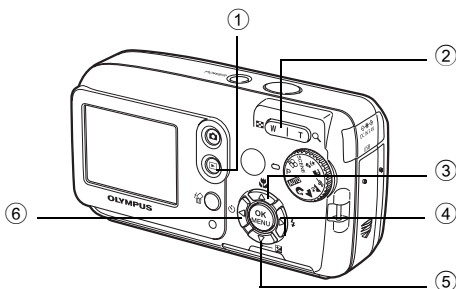

Estando en el modo de fotografía, utilice estos botones para acceder rápidamente a algunas de las características de uso más habitual.



Es

- 1 Botón  (Reproducción)**
Activa el modo de reproducción
- 2 Botón de zoom**
W: Para fotografía en gran angular
T : Para fotografía en telefoto
- 3 Botón  (Macro)**
Activa el modo de macro o súper macro
- 4 Botón  (Modo de flash)**
Para seleccionar el modo de flash
- 5 Botón  (Compensación de la exposición)**
Para realizar cambios avanzados al ajuste de exposición
- 6 Botón  (Disparador automático)**
El disparador automático se enciende/se apaga.

Modos de preselección de escena

- 1 Sitúe el disco de modo en **SCENE**, presione  y luego seleccione [SELECCION DE ESCENA].
- 2 Presione  o  para seleccionar un modo de escena, y presione .

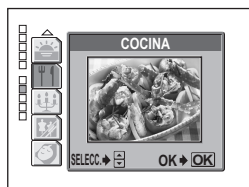









Descripciones de los modos de preselección de escena



- AUTO-RETRATO
- INTERIORES
- PLAYA
- NIEVE
- FUEG.ARTIF.
- PUESTA DE SOL
- COCINA
- VELAS
- VITRINA
- NATURAL

Es

Modo macro





-  Este modo le permite fotografiar a 20 cm del sujeto (cuando el gran angular óptico en el gran angular máximo).
 -  Este modo le permite fotografiar a 2 cm del sujeto. En el modo [], también se puede fotografiar en condiciones normales, si bien la posición del zoom se fija automáticamente sin que se pueda ajustar.
- 1 Presione  .
 - Aparecerá la pantalla de opciones del modo macro.
- 2 Seleccione [] o [], y presione .



Disparador automático

- 1 Presione .
 - Aparecerá la pantalla de opciones del disparador automático.
- 2 Seleccione [ACTIVADO] y presione .
- 3 Presione el botón disparador a fondo para hacer la fotografía.
 - El LED del disparador automático se ilumina durante unos 10 segundos cuando se presiona el botón obturador, y luego parpadea. Tras parpadear durante 2 segundos aproximadamente, se realiza la fotografía.





Modos de flash

- 1 Presione .
 - Se muestra la pantalla de selección del modo de flash.
- 2 Presione  para seleccionar un modo de flash y presione .
- 3 Presione a medias el botón disparador.
 - Cuando el flash esté listo para dispararse, la marca  se ilumina de forma permanente.
- 4 Presione el botón disparador a fondo para hacer la fotografía.
 Alcance del flash:
 W (máx.) : De 0,2 m a 3,7 m aprox.
 T (máx.) : De 0,6 m a 2,1 m aprox.

Icono	Modo de flash	Descripción
Sin indicación	Flash automático	El flash se dispara automáticamente en condiciones de baja iluminación o de contraluz.
	Flash con reducción de ojos rojos	El modo de flash con reducción de ojos rojos reduce este fenómeno de manera significativa emitiendo destellos previos antes de que se dispare el flash regular.
	Flash de relleno	El flash se dispara independientemente de la luz disponible.
	Flash desactivado	El flash no se dispara, aún en condiciones de baja iluminación.

MENÚS Y AJUSTES

Menú superior

- 1 Presione .
 - Aparece el menú superior.
- 2 Utilice las teclas de control y  para desplazarse y seleccionar opciones.

Esto hace referencia a las teclas de control (   ).

Menú superior en modo **P**

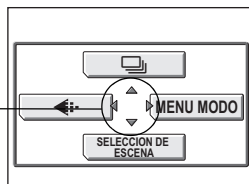

Mode de grabacion

Elija entre varios modos de calidad de imagen y resoluciones.

Fotografía secuencial

Hace fotografías de forma sucesiva. El enfoque, la exposición y el balance de blancos se bloquean en el primer cuadro.



SELECCIÓN DE ESCENA

Esta función le permite seleccionar entre 10 modos de situación configurados según las condiciones de fotografía.

MENÚ MODO

Contiene la selección de idioma, opciones de inicio, fecha y hora, formatear/borrar.

Borrar todas las fotografías

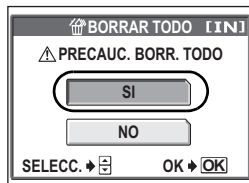

- 1 En el modo de fotografía, presione  y seleccione [MENU MODO] > [MEMORIA (TARJETA)] > [BORRAR TODO].
- 2 Seleccione [SI] y presione .
 - Se borran todas las fotografías.



Es

Seleccione un idioma

Se puede seleccionar un idioma para las indicaciones en pantalla. Los idiomas disponibles varían dependiendo de la zona donde se ha adquirido la cámara.

- 1 Presione  y seleccione [MENU MODO] > [CONFIG.] > .
- 2 Seleccione un idioma y presione .









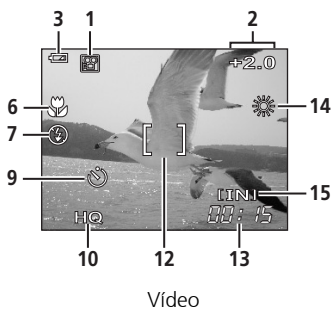
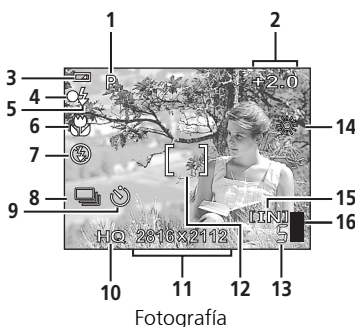

Símbolos e iconos del monitor

Es

Monitor – modo de fotografía



	Opción	Indicaciones
1	Modo de fotografía	P , AUTO ,  ,  ,  ,  ,  ,  , 
2	Compensación de la exposición	-2,0 – +2,0
3	Verificación de la batería	 = carga completa,  = carga baja
4	Piloto verde	○ = Bloqueo del enfoque automático

	Opción	Indicaciones
5	Flash en espera Carga de flash	⚡ (Se enciende) ⚡ (Parpadea)
6	Modo macro Modo supermacro	🌿 S🌿
7	Modo de flash	👁️, ⚡, 🔋
8	Fotografía secuencial	📄
9	Disparador automático	🔄
10	Modo de grabación	SHQ, HQ, SQ1, SQ2, SQ
11	Tamaño de imagen	2816 x 2112, 1600 x 1200, 640 x 480
12	Marca de objetivo de enfoque automático (AF)	[]
13	Número de fotografías almacenables Tiempo de grabación restante	5 00:15
14	Balace de blancos	☀️, ☁️, 🌑, 🌒
15	Memoria	[IN] (memoria interna), [xD] (tarjeta)
16	Indicador de memoria	🔋, 📶, 📱, 📡 (no puede hacer fotografías)

Es

Monitor – modo de reproducción



Fotografía

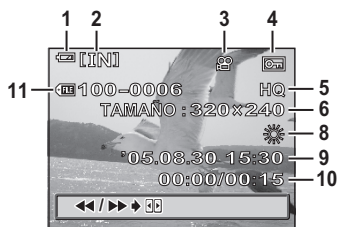

Vídeo

	Opción	Indicaciones
1	Verificación de la batería	= carga completa, = carga baja
2	Memoria	[IN] (memoria interna), [xD] (tarjeta)
3	Reserva de impresión/ número de copias	× 10
	Vídeo	
4	Protección	
5	Modo de grabación	SHQ, HQ, SQ1, SQ2, SQ
6	Tamaño de imagen	2816 × 2112, 1600 × 1200, 640 × 480, 320 × 240
7	Compensación de la exposición	-2,0 – +2,0
8	Balance de blancos	WB AUTO, , , ,
9	Fecha y hora	'05.08.30 15:30
10	Número de cuadro	5
	Tiempo de reproducción/ Tiempo total de grabación	00:00/00:15
11	Número de archivo	100 – 0005

Es

Vista (Índice) de miniaturas

Esta función le permite mostrar varias fotografías al mismo tiempo en la pantalla. Al revisar las fotografías, presione el botón de zoom hacia W () para cambiar a la vista (Índice) de miniaturas.

- Utilice las teclas de control para seleccionar la fotografía.
- Para volver a la reproducción de un solo cuadro, presione el botón de zoom hacia T ()

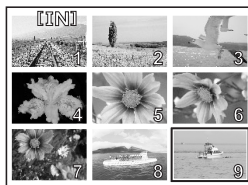

CONEXIÓN DE LA CÁMARA

Impresión directa (PictBridge)

Utilizando el cable USB suministrado, puede conectar la cámara directamente a una impresora compatible con PictBridge como la Olympus P-11 para imprimir copias.

- 1 Conecte un extremo del cable USB suministrado al conector USB de la cámara y el otro, al conector USB de la impresora.

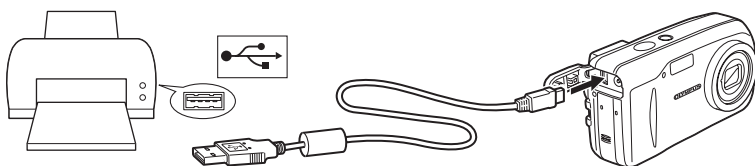

- 2 Seleccione [IMPRIMIR] en el monitor de la cámara y presione . Cuando se cierre la pantalla [UN MOMENTO], la cámara y la impresora están conectadas.

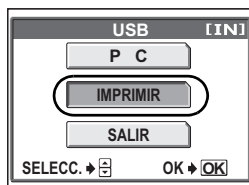

Impresión directa (PictBridge) continuación...

- 3 Utilice las teclas de control para seleccionar las imágenes e imprimir las copias.

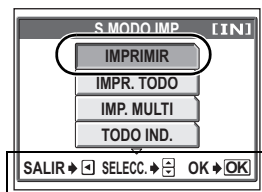

Siga las instrucciones que se muestran aquí.

IMPRIMIR

Imprime la fotografía seleccionada.

IMPR. TODO

Imprime todas las fotografías almacenadas en la memoria interna o en la tarjeta.

IMP. MULTI

Imprime una fotografía en formato de diseño múltiple.

TODOS IND.

Imprime un índice de todas las fotografías almacenadas en la memoria interna o en la tarjeta.

ORDEN IMPRESIÓN

Imprime las fotografías de acuerdo con los datos de reserva de impresión almacenados en la memoria interna o en la tarjeta. Si no hubiera efectuado reservas de impresión, esta opción no se mostrará.

SOFTWARE OLYMPUS MASTER

Software OLYMPUS Master: ¡Utilice este software para descargar fotografías desde la cámara, ver, organizar, retocar, imprimir y mandar por correo electrónico e imprimir sus fotos digitales, vídeos y mucho más! Este CD incluye también el manual de usuario completo del software en formato Adobe Acrobat (PDF).



Requisitos del sistema

SO	Windows 98SE/Me/2000Professional/XP o Mac OS X (10.2 o posterior)
CPU	Pentium III 500MHz / Power PC G3 500 MHz o posterior
RAM	128MB o más (se recomienda al menos 256MB)
Disco duro	300MB o más
Conexión	puerto USB
Monitor	Windows : 1.024 x768 píxeles, 65.536 colores o más Macintosh : 1.024 x768 píxeles, 32.000 colores o más

Si desea consultar la información de asistencia técnica más reciente, visite la página web de Olympus (<http://www.olympus.com/digital>)



Registro de usuario

Registre su cámara cuando instale OLYMPUS Master para activar su garantía, recibir avisos de actualizaciones de software y del firmware de la cámara, y mucho más.

Es

ESPECIFICACIONES

Cámara

Tipo de producto	: Cámara digital (para fotografía y visualización)
Sistema de grabación	
Fotografía	: Grabación digital, JPEG (de acuerdo con las Normas de Diseño para Sistema de Archivos de Cámara (DCF))
Estándares aplicables	: Exif 2.2, Formato de Reserva de Impresión Digital (DPOF), PRINT Image Matching III, PictBridge
Vídeo	: Soporte QuickTime Motion JPEG
Memoria	: Memoria interna xD-Picture Card (16 MB-1 GB)
Tamaño de imagen	: 2.816 × 2.112 píxeles (SHQ) 2.816 × 2.112 píxeles (HQ) 1.600 × 1.200 píxeles (SQ1) 640 × 480 píxeles (SQ2)
Núm. de fotografías almacenables (cuando utiliza la tarjeta de 32 MB xD-Picture Card)	: Aprox. 7 cuadros (SHQ) Aprox. 21 cuadros (HQ) Aprox. 64 cuadros (SQ1) Aprox. 331 cuadros (SQ2)
Núm. de píxeles efectivos	: Aprox. 6.000.000 píxeles
Elemento captador de imágenes	: 1/2,5" Elemento captador de imagen CCD de estado sólido, 6.370.000 píxeles (brutos)
Objetivo	: Objetivo Olympus de 6,3 a 18,9 mm, de f2,8 a 4,9 (equivalente a un objetivo de 38 a 114 mm en una cámara de 35 mm)
Sistema fotométrico	: Medición ESP digital
Velocidad de obturación	: De 4 a 1/2.000 seg.
Alcance de fotografía	: De 0,5 m a ∞ (W), de 0,9 m a ∞ (T) (normal) De 0,2 m a ∞ (W), de 0,6 m a ∞ (T) (modo macro)
Monitor	: 1,8" Pantalla LCD TFT a color de 85.000 píxeles
Enfoque automático	: Método de detección de contraste
Conector exterior	: Jack DC-IN, conector USB
Sistema de calendario automático	: De 2005 hasta 2099

Entorno de funcionamiento

Temperatura	: De 0°C a 40°C (funcionamiento)/de -20°C a 60°C (almacenamiento)
Humedad	: Del 30% al 90% (funcionamiento)/del 10% al 90% (almacenamiento)
Fuente de alimentación	: Dos baterías Oxyride, dos baterías alcalinas o dos baterías NiMH tipo AA (R6)/ Una batería de litio (CR-V3)/Adaptador de CA Olympus (opcional)
Dimensiones	: 106 mm (Anch.) x 56 mm (Alt.) x 36 mm (Prof.) excluyendo los salientes
Peso	: 140 g sin la batería ni la tarjeta

El diseño y las especificaciones están sujetas a cambios sin previo aviso.

xD-Picture Card

Es

Tipo de memoria	: NAND flash EEPROM
Entorno de funcionamiento	
Temperatura	: De 0°C a 55°C (funcionamiento)/ De -20°C a 65°C (almacenamiento)
Humedad	: 95% o inferior
Alimentación	: 3V (3,3V)
Dimensiones	: 20 x 25 x 1,7 mm

PRECAUCIONES DE SEGURIDAD



PRECAUCIÓN

RIESGO DE DESCARGAS
ELÉCTRICAS NO ABRIR



PRECAUCIÓN: PARA REDUCIR EL RIESGO DE DESCARGAS ELÉCTRICAS, NO RETIRE LA CUBIERTA (O PARTE TRASERA). EN EL INTERIOR NO HAY PIEZAS QUE EL USUARIO PUEDA REPARAR. REMITA LA REPARACIÓN A PERSONAL DE SERVICIO ESPECIALIZADO OLYMPUS.



El signo de admiración dentro de un triángulo equilátero tiene como finalidad alertar al usuario de la existencia de importantes instrucciones de operación y mantenimiento en la documentación suministrada con el producto.



PELIGRO

Si el producto es utilizado sin observar la información representada bajo este símbolo, podría causar serias lesiones o muerte.



ADVERTENCIA

Si el producto es utilizado sin observar la información representada bajo este símbolo, podría causar serias lesiones o muerte.



PRECAUCIÓN

Si el producto es utilizado sin observar la información representada bajo este símbolo, podría causar lesiones personales menores, daños al equipo, o pérdida de datos importantes.

¡ADVERTENCIA!

PARA EVITAR EL RIESGO DE INCENDIO O DESCARGAS ELÉCTRICAS, NUNCA EXPONGA ESTE PRODUCTO AL AGUA NI LO UTILICE EN UN ENTORNO MUY HÚMEDO.

Precauciones Generales

Lea todas las instrucciones — Antes de utilizar este producto, lea todas las instrucciones operativas. Conserve todos los manuales y documentación para referencia futura.

Limpieza — Siempre desenchufe el producto de la toma de corriente antes de limpiarlo. Para la limpieza use sólo un paño húmedo. Nunca use limpiadores líquidos o aerosoles, ni solventes orgánicos de ningún tipo para limpiar este producto.

Accesorios — Para su seguridad y evitar daños al producto, utilice únicamente los accesorios recomendados por Olympus.

Agua y humedad — Para obtener información sobre las precauciones de los productos diseñados a prueba de la intemperie, consulte las secciones de resistencia a la intemperie.

Ubicación — Para evitar daños al producto, móntelo de forma segura sobre un trípode, base o soporte estable.

Fuentes de alimentación — Conecte este producto únicamente con la fuente de alimentación descrita en la etiqueta del producto.

Rayos — Si se produce una tormenta eléctrica mientras está utilizando un adaptador de CA, retírelo de la toma de corriente mural inmediatamente.

Objetos extraños — Para evitar daños personales, nunca inserte objetos de metal en el producto.

Calentadores — Nunca utilice ni guarde este producto cerca de fuentes de calor, tales como radiadores, rejillas de calefacción, estufas o cualquier tipo de equipo o aparato generador de calor, incluyendo amplificadores estéreo.

Manejo de la Cámara



ADVERTENCIA

- **No utilice la cámara cerca de gases inflamables o explosivos.**
- **No utilice el flash a corta distancia de las personas (especialmente niños menores y mayores, etc.).**
 - Debe mantener, por lo menos, una distancia de 1 m de la cara de los sujetos. Si dispara el flash demasiado cerca de los ojos del sujeto, podría causarle la pérdida de visión momentánea.
- **Mantenga a los niños menores y mayores alejados de la cámara.**
 - Utilice y guarde siempre la cámara fuera del alcance de los niños menores y mayores, para prevenir las siguientes situaciones de peligro que podrían causarles serias lesiones:
 - Enredarse con la correa de la cámara, ocasionando asfixia.
 - Ingerir accidentalmente una pila, tarjetas, u otras piezas pequeñas.
 - Disparar el flash accidentalmente hacia sus propios ojos o hacia los ojos de otro niño.
 - Lesionarse accidentalmente con las piezas móviles de la cámara.
- **No apunte la cámara directamente al sol o a luces fuertes.**
- **No utilice ni guarde la cámara en lugares polvorientos o húmedos.**
- **No cubra el flash con la mano mientras efectúa el disparo.**



PRECAUCIÓN

- **Interrumpa inmediatamente el uso de la cámara si percibe algún olor, ruido o humo extraño alrededor de la misma.**
 - Nunca retire las baterías con las manos descubiertas, ya que podría causar un incendio o quemarle las manos.
- **Nunca sostenga ni utilice la cámara con las manos mojadas.**
- **No deje la cámara en lugares donde pueda estar sujeta a temperaturas extremadamente altas.**
 - Si lo hace puede provocar el deterioro de las piezas y, en algunas circunstancias, provocar que se prenda fuego. No utilice el cargador o el adaptador CA si está cubierto (por ejemplo con una frazada). Esto podría causar recalentamiento, resultando en incendio.
- **Manipule la cámara con cuidado para evitar una quemadura de baja temperatura.**
 - Ya que la cámara contiene partes metálicas, el recalentamiento puede resultar en una quemadura de baja temperatura. Preste atención a lo siguiente:
 - Cuando la utilice durante un largo período, la cámara se recalentará. Si mantiene a la cámara en este estado, podría causar una quemadura de baja temperatura.
 - En lugares sujetos a temperaturas extremadamente bajas, la temperatura de la carcasa de la cámara puede ser más baja que la temperatura ambiente. Si es posible, póngase guantes cuando manipule la cámara en temperaturas bajas.
- **Tenga cuidado con la correa.**
 - Tenga cuidado con la correa cuando transporte la cámara. Podría engancharse en objetos – sueltos y provocar daños graves.

Precauciones acerca del uso de las pilas

Siga estas importantes indicaciones para evitar que se produzcan fugas, recalentamientos, incendios o explosión de las pilas, o que cause descargas eléctricas o quemaduras.

PELIGRO

- Utilice únicamente baterías NiMH de la marca Olympus y el cargador correspondiente.
- Nunca caliente ni incinere las pilas.
- Tome precauciones al transportar o guardar las pilas a fin de evitar que entren en contacto con objetos metálicos, tales como alhajas, horquillas, cierres, etc.
- Nunca guarde las pilas en lugares donde queden expuestas a la luz solar directa o sujetas a altas temperaturas en el interior de un vehículo con calefacción, cerca de fuentes de calor, etc.
- Para evitar que ocurran fugas de líquido de las pilas o daños de sus terminales, siga cuidadosamente todas las instrucciones respectivas al uso de las pilas. Nunca intente desarmar una pila ni modificarla de ninguna manera, por soldadura, etc.
- Si el fluido de la pila penetrara en sus ojos, lávelos de inmediato con agua corriente fresca y limpia, y solicite atención médica inmediatamente.
- Siempre guarde las pilas fuera del alcance de los niños menores. Si un niño ingiere una pila accidentalmente, solicite atención médica inmediatamente.

ADVERTENCIA

- Conserve las pilas siempre secas.
- Para evitar que ocurran fugas de líquido, recalentamiento de las pilas, o que causen incendio o explosión, utilice únicamente las pilas recomendadas para este producto.
- Nunca mezcle las pilas (pilas nuevas con usadas, pilas cargadas con descargadas, pilas de distinta marca o capacidad, etc.).
- Nunca intente recargar las pilas alcalinas, baterías de litio o las baterías de litio CR-V3.
- Inserte la batería con cuidado como se describe en las instrucciones operativas.
- No utilice baterías si el cuerpo no está cubierto con una lámina aislante o si dicha lámina está perforada, ya que podría provocar fugas de líquido, incendio o lesión.



PRECAUCIÓN

- No retire las baterías inmediatamente después de utilizar la cámara. Las baterías pueden recalentarse durante el uso prolongado.
- Siempre retire la batería de la cámara antes de guardar la cámara por un largo tiempo.

• Las siguientes pilas AA no pueden ser utilizadas.

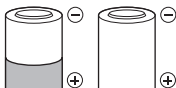

Pilas parcialmente cubiertas o no cubiertas totalmente por una hoja aislante.



Pilas con terminales \ominus en relieve, pero no cubiertos por una hoja aislante.

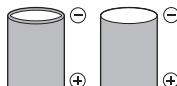

Pilas con terminales planos, pero no completamente cubiertos por una hoja aislante (Tales pilas no pueden ser usadas aunque los terminales \ominus estén parcialmente cubiertos).

- Si las pilas de NiMH no se recargan dentro del tiempo especificado, interrumpa la recarga de las mismas y no las use.
- No utilice una pila si está rajada o quebrada.
- Si se producen fugas de líquido, decoloración o deformación de la batería, o cualquier otra anomalía durante la operación, interrumpa el uso de la cámara.
- Si el fluido de la pila entrara en contacto con su ropa o con su piel, quítese la ropa y lave de inmediato la parte afectada con agua corriente fresca y limpia. Si el fluido quemara su piel, solicite atención médica inmediatamente.
- Nunca exponga la pila a fuertes impactos ni a vibraciones continuas.

Para los clientes de Norte y Sudamérica

Para los clientes de Estados Unidos

Declaración de conformidad

Número de modelo : FE-120/X-700

Nombre comercial : OLYMPUS

Entidad responsable : **OLYMPUS IMAGING AMERICA INC.**

Dirección : Two Corporate Center Drive, P.O. Box 9058, Melville, NY
11747-9058 EE.UU.

Número de teléfono : 1-631-844-5000

Se ha probado su cumplimiento con las normas FCC

PARA USO DOMÉSTICO O COMERCIAL

Este dispositivo cumple con el Apartado 15 de las normas FCC. La operación se encuentra sujeta a las dos condiciones siguientes:

(1) Este dispositivo podría no causar interferencia perjudicial.

(2) Este dispositivo debe aceptar cualquier interferencia que se reciba, incluyendo aquellas interferencias que pueden provocar un funcionamiento no deseado.

Para los clientes de Canadá

Este aparato digital de Clase B cumple con todos los requerimientos de las reglamentaciones canadienses sobre equipos generadores de interferencia.

Es

Marcas comerciales

- IBM es una marca registrada de International Business Machines Corporation.
- Microsoft y Windows son marcas registradas de Microsoft Corporation.
- Macintosh es una marca comercial de Apple Computer Inc.
- xD-Picture Card™ es una marca comercial.
- Todos los demás nombres de compañías y productos son marcas registradas y/o marcas comerciales de sus respectivos propietarios.
- Las normas para sistemas de archivos de cámara referidas en este manual son las "Normas de Diseño para Sistema de Archivos de Cámara/DCF" estipuladas por la Asociación de Industrias Electrónicas y de Tecnología de Información de Japón (JEITA).

MEMO

ÍNDICE

DIAGRAMA DA CÂMARA	87
ANTES DE COMEÇAR	88
PARA COMEÇAR	89
Passo 1 - PARA COMEÇAR	89
Passo 2 - FOTOGRAFE	90
Passo 3 - REVEJA OU APAGUE UMA IMAGEM.....	91
Passo 4 - TRANSFIRA IMAGENS	92
OPERAÇÕES BÁSICAS	94
Informações sobre fotografia.....	94
Função de poupança de energia.....	94
Selector de modo	95
Botões do modo fotografia	96
Modos de cena	97
Modo Macro	97
Temporizador automático	98
Modos Flash.....	98
MENUS E DEFINIÇÕES	99
Menu superior.....	99
Apagar todas as imagens	99
Seleccionar um idioma	100
Símbolos e ícones no ecrã	100
Exibição de imagens em miniatura (índex).....	102
LIGAÇÕES DA CÂMARA	103
Impressão directa (PictBridge).....	103
SOFTWARE OLYMPUS MASTER	105
ESPECIFICAÇÕES	106
PRECAUÇÕES DE SEGURANÇA	108

- Antes de utilizar a sua câmara, leia atentamente este manual para garantir a sua utilização correcta.
- Nós recomendamos que obtenha imagens de teste para que se acostume com a sua câmara antes de tirar fotografias importantes.
- Não deixe de observar as precauções de segurança no final deste manual.

DIAGRAMA DA CÂMARA

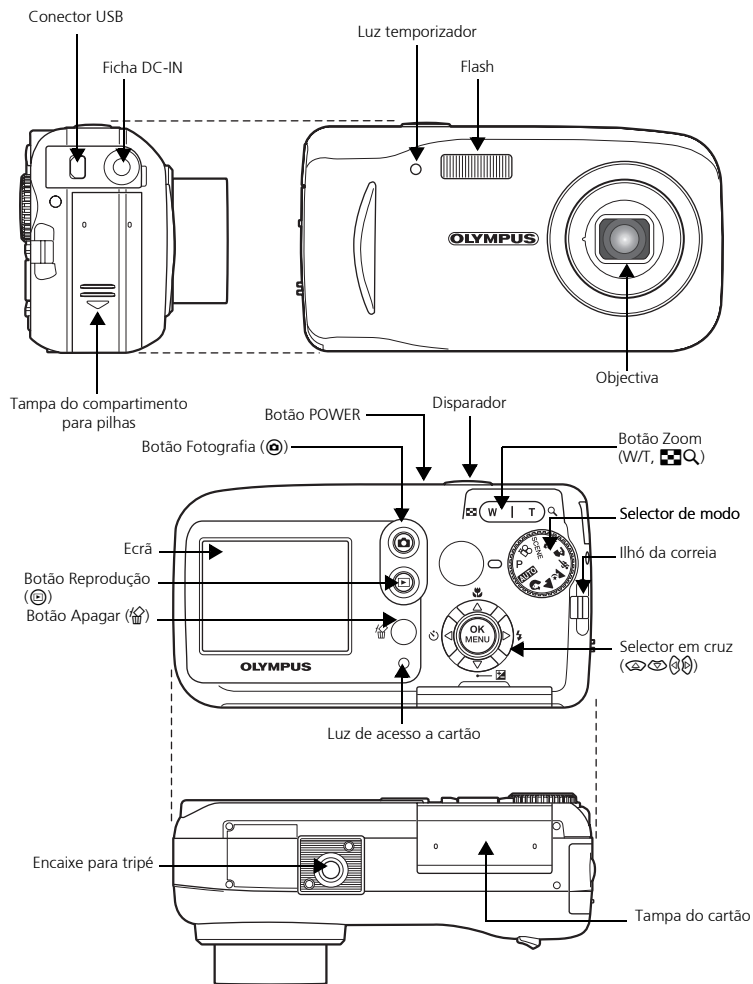

Po

ANTES DE COMEÇAR

Reuna estes itens (conteúdo da caixa)



Câmara Digital



Correia



xD-Picture Card



Pilhas formato AA (R6)
(duas)



Cabo USB



CD-ROM do software
OLYMPUS Master

Esta embalagem também contém: Manual Avançado (CD-ROM), Manual Básico (este manual), Cartão de Garantia, Cartão de Registo. O conteúdo pode variar conforme o local de aquisição.

1 PARA COMEÇAR

a. Encaixe a correia.

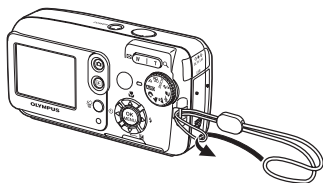

b. Introduza as pilhas.

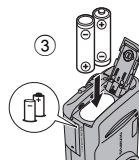
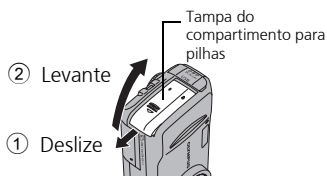

c. Acerte a data e a hora.

- ① Ajuste o selector de modo a **AUTO** e active a energia da câmara. De seguida, carregue no botão e seleccione

Selector de modo



- ② Carregue em / definir o parâmetro. Carregue em / para seleccionar o próximo campo.

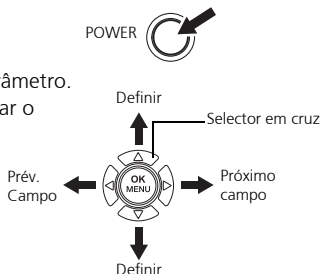
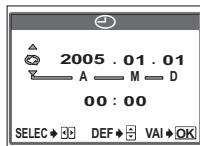

2 FOTOGRAFE

a. Zoom

Reduzir:

OU

Ampliar:

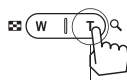
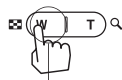

Po

b. Focagem

- 1 Utilize o ecrã para posicionar a marca AF sobre o seu motivo.

Luz verde



Marca AF

(Meio-premido)



Botão
Disparador

- 2 Mantenha premido o botão disparador à metade para fixar o foco. A luz verde indica que o foco está fixo.

c. Fotografe

Prima completamente o botão disparador para fotografar a imagem.

(Completamente premido)



Botão
Disparador

3 REVEJA OU APAGUE UMA IMAGEM



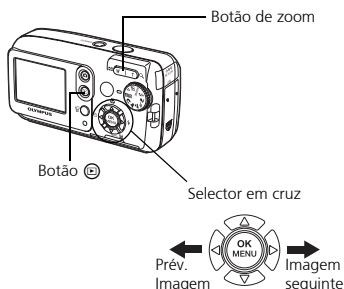

a. Carregue em

A última imagem fotografada será exibida.



b. Dê uma olhada mais de perto

Carregue em    para ampliar ou reduzir a imagem.

Carregue em  /  ou  /  para passar outras imagens.

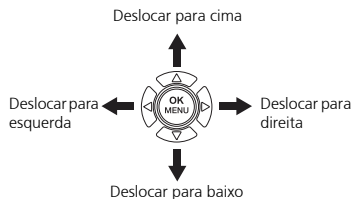





Carregue no botão  para retornar ao modo fotografia.

Po

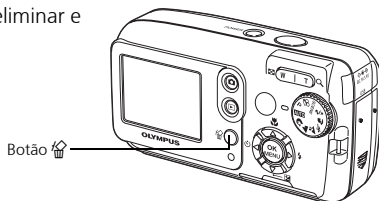
c. Para apagar uma imagem

- 1 Visualizar a imagem que pretende eliminar e premir no botão .



- 2 Carregue em  /  para seleccionar [SIM] e, de seguida, carregue no botão . A imagem é permanentemente eliminada.



4 TRANSFIRA IMAGENS

a. Instale o software

- 1 Insira o CD-ROM OLYMPUS Master fornecido na unidade para CD-ROM.
- 2 **Windows:** Clique no botão "OLYMPUS Master".
Macintosh: Faça duplo clique no ícone "Installer".
- 3 Simplesmente siga as instruções no ecrã.





Po

b. Ligue a câmara ao computador

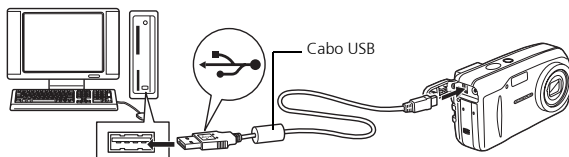
- 1 Ligue a câmara e o computador usando o cabo USB (incluído). O ecrã acender-se-á automaticamente.



- 2 Pressione  /  para seleccionar [PC] e pressione o botão .

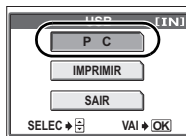

Agora, o seu PC reconhecerá a sua câmara como uma unidade de armazenamento removível.

c. Transfira imagens ao computador

- 1 Com a câmara agora ligada, abra o OLYMPUS Master.
Deverá aparecer a janela de transferência.
- 2 Selecciona as imagens que deseja transferir e clique no botão [Transfer images] (Transferir imagens).

Se a janela de transferência de imagens não aparecer automaticamente:

- a. Clique no ícone "Transfer Images" (Transferir imagens).
- b. Clique no ícone "From Camera" (Da câmara) e, de seguida, clique em [Transfer images] (Transferir imagens).



Botão Transfer images
(Transferir imagens)



Nota

Para mais detalhes sobre a utilização do software OLYMPUS Master, consulte o Manual de Referência (electrónica) localizado na pasta OLYMPUS Master no seu hard drive. Adicionalmente, pode-se consultar o ficheiro "Help" (Ajuda) no software OLYMPUS Master.

OPERAÇÕES BÁSICAS

Informações sobre fotografia

As imagens poderão aparecer desfocadas se a câmara for movida durante o premir do botão disparador.

Para evitar a oscilação da câmara, segure-a firmemente com ambas as mãos, enquanto mantém os cotovelos junto a si. Ao fotografar com a câmara na posição vertical, segure a câmara de tal modo que o flash fique posicionado acima da objectiva.

Mantenha os dedos e a correia afastados da objectiva e do flash.

Posição horizontal

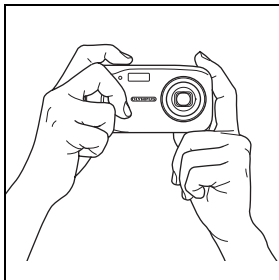

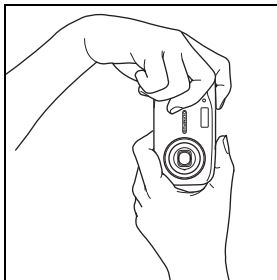

Posição vertical



Po

Função de poupança de energia





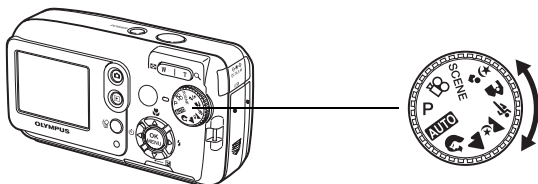

Para economizar a carga da pilha, a câmara entrará automaticamente no modo de repouso e deixará de funcionar se não for utilizada no intervalo de 3 minutos. O monitor desligar-se-á automaticamente. Pressione o botão de disparo do obturador,  ou  para acender o monitor.

Se a câmara não for operada por 4 horas após a entrada no modo de repouso, a objectiva será automaticamente retraída e a máquina se desligará. Para retomar o funcionamento, ligue a energia novamente.

Selector de modo

Esta câmara apresenta um selector de modo com o qual se pode seleccionar o modo de filmagem da câmara. Poderá alterar os modos de filmagem em qualquer momento.



P	Ideal para situações gerais.
AUTO	Fotografa no modo automático total.
	Ideal para fotografar retratos.
	Ideal para fotografar paisagens.
	Ideal para fotografias nocturnas.
	Ideal para fotografar assuntos fotográficos em movimento.
	Ideal para fotografar o seu assunto fotográfico à frente de uma paisagem.
	Ideal para fotografar o seu assunto fotográfico à frente de um cenário nocturno.
SCENE	Esta função permite-lhe seleccionar dentre 10 modos programados para fotografar em determinadas situações.
	Grava vídeos.

Po

Botões do modo fotografia

Durante o modo de filmagem, utilize estes botões para ter rápido acesso a algumas das funções mais comumente utilizadas.

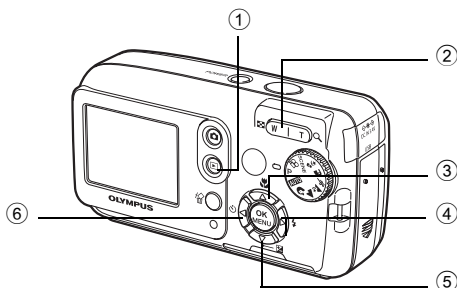

① Botão (Reprodução)

Habilita o modo reprodução.

② Botão Zoom

W: Para fotografar em grande angular

T: Para fotografar em telefoto

③ Botão (Macro)

Habilita o modo macro ou super macro.

④ Botão (Modo flash)

Para seleccionar o modo do flash





⑤ Botão (Compensação de exposição)

Para efectuar alterações finas no ajuste da exposição

⑥ Botão (Temporizador automático)

Activa/desactiva o temporizador automático.

Modos de cena

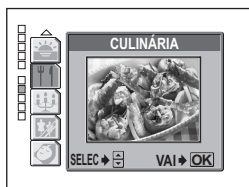

- 1 Ajuste o disco de modo em **SCENE** e pressione  para seleccionar [SELECÇÃO DE CENA].
- 2 Carregue em  ou  para seleccionar um modo de cena e, de seguida, carregue em .







Descrições de modo de cenas

- AUTO-RETRATO
- INTERIORES
- PRAIA
- NEVE
- FOGOS DE ARTIFÍCIO
- PÓR-DO-SOL
- CULINÁRIA
- VELA
- ATRÁS DE VIDRO
- RETRATO SOB LUZ AMBIENTE

Modo Macro

-  Este modo permite-lhe fotografar de uma posição tão próxima quanto 20 cm do seu assunto fotográfico (quando o zoom óptico estiver no máximo grande angular).
-  Este modo permite-lhe fotografar de uma posição tão próxima quanto 2 cm do seu assunto fotográfico. No modo [, a fotografia normal também é possível, mas a posição do zoom é automaticamente fixada e não pode ser regulada.

- 1 Carregue em  .
 - Surte o ecrã das definições de Macro.
- 2 Selecione [, ou [ e carregue em .

Temporizador automático

- 1 Carregue em .
 - Surge o ecrã das definições do temporizador.
- 2 Seleccione [LIGADO], e carregue em .
- 3 Prima totalmente o botão disparador para fotografar.
 - A lâmpada do temporizador automático acender-se-á por aproximadamente 10 segundos depois que o botão de disparo do obturador for pressionado e, então, começará a piscar. Depois de piscar durante aproximadamente 2 segundos, a imagem é fotografada.





Modos Flash

- 1 Carregue em .
 - Surge o ecrã de definição do modo Flash.
- 2 Carregue em / para seleccionar o modo flash e, de seguida, carregue em .
- 3 Prima o botão disparador até ao meio.
 - Quando o flash é definido para disparar, a marca acende-se estavelmente.
- 4 Prima totalmente o botão disparador para fotografar.
Alcance fotográfico do flash:
W (máx.) : Aprox. 0,2 m a 3,7 m
T (máx.) : Aprox. 0,6 m a 2,1 m

Ícone	Modo Flash	Descrição
Nenhuma indicação	Flash automático	O flash dispara automaticamente em condições de luz fraca ou contraluz.
	Flash de redução do efeito olhos vermelhos	O modo flash de redução do efeito de olhos vermelhos reduz este fenómeno, emitindo pré-flashes antes de disparar o flash habitual.
	Flash forçado	O flash dispara independentemente da luz disponível.
	Flash desligado	O flash não dispara mesmo em situações de luz fraca.

MENUS E DEFINIÇÕES

Menu superior

- 1 Prima .
 - O menu superior é exibido.
- 2 Utilize as teclas de controlo e  para navegar e seleccionar os itens.

Este refere-se ao selector em cruz (⤵⤴⤶⤷).

Menu superior no modo **P**

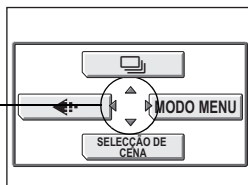

Modo gravação

Escolha dentre os diversos modos de qualidade de imagem e resoluções.

Fotografia de sequência

Fotografa imagens estáticas em sucessão. O foco, a exposição e o balanço de brancos são fixos no primeiro quadro.



SELECCÃO DA CENA

Esta função permite-lhe seleccionar dentre 10 modos programados para fotografar em determinadas situações.

MODO MENU

Contém parâmetros de selecção de idioma, opções de disparo, data e hora, formatar/apagar.

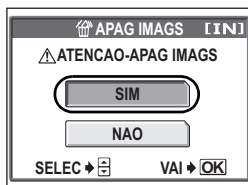

Apagar todas as imagens

- 1 Durante o modo de filmagem, carregue em  e seleccione [MODO MENU] > [MEMORIA (CARTÃO)] > [APAG IMAGS].
- 2 Seleccione [SIM], e carregue em .
 - Todas as imagens são apagadas.



Seleccionar um idioma

Pode-se seleccionar um idioma para as indicações no ecrã. Os idiomas disponíveis variam conforme o local onde adquiriu esta câmara.

- 1 Carregue em  e seleccione [MODO MENU] > [DEFIN] > .
- 2 Seleccione um idioma e prima .









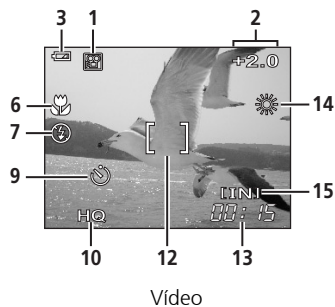
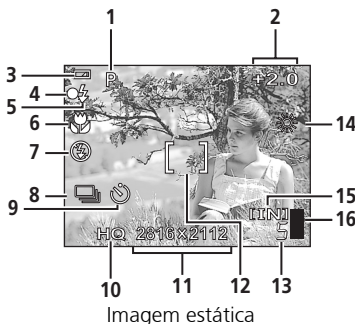

Símbolos e ícones no ecrã

Ecrã - modo fotografia

Po



	Item	Indicações
1	Modo fotografia	P , AUTO ,  ,  ,  ,  ,  , 
2	Compensação da exposição	-2,0 – +2,0
3	Verificação das pilhas	 = carga total,  = carga baixa
4	Luz verde	 = Fixação automática do foco

	Item	Indicações
5	Flash em espera Carregamento do flash	⚡ (Acende-se) ⚡ (Pisca)
6	Modo Macro Fotografia super Macro	🌸 S
7	Modo Flash	👁️, ⚡, 🔋
8	Fotografia de sequência	📄
9	Temporizador	🕒
10	Modo gravação	SHQ, HQ, SQ1, SQ2, SQ
11	Tamanho da imagem	2816 x 2112, 1600 x 1200, 640 x 480
12	Marca AF	[]
13	Número de imagens paradas graváveis Tempo de gravação disponível	5 00:15
14	Balanço de brancos	☀️, ☁️, 🌑, 🌒
15	Memória	[IN] (memória interna), [xD] (cartão)
16	Capacidade da memória	📶, 📶, 📶, 📶 (não se pode fotografar)

Po

Ecrã - modo reprodução



Imagem estática

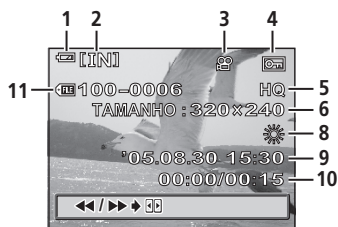

Vídeo

Ecrã - modo reprodução continuação...

	Item	Indicações
1	Verificação das pilhas	= carga total, = carga baixa
2	Memória	[IN] (memória interna), [xD] (cartão)
3	Reserva de impressão/ número de impressões	x10
	Vídeo	
4	Proteger	
5	Modo gravação	SHQ, HQ, SQ1, SQ2, SQ
6	Tamanho da imagem	2816 x 2112, 1600 x 1200, 640 x 480, 320 x 240
7	Compensação da exposição	-2,0 – +2,0
8	Balanço de brancos	WB AUTO, , , ,
9	Data e hora	'05.08.30 15:30
10	Número do quadro	5
	Tempo de reprodução/ Tempo de gravação total	00:00/00:15
11	Número de ficheiro	100 – 0005

Po

Exibição de imagens em miniatura (índex)

Esta função permite-lhe exibir várias imagens ao mesmo tempo no ecrã.

Quando for rever as suas imagens, prima o botão zoom em direcção a W () para passar à exibição de imagens em miniatura (índex).

- Utilize o selector em cruz para seleccionar a imagem.
- Para retornar à reprodução de um único quadro, pressione o botão de zoom em direcção a T ()

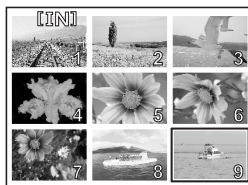

LIGAÇÕES DA CÂMARA

Impressão directa (PictBridge)

Por meio do cabo USB fornecido, pode-se ligar esta câmara directamente a uma impressora compatível com PictBridge, tal como a Olympus P-11, para fazer impressões.

- 1 Ligue uma extremidade do cabo USB fornecido no conector USB da câmara, e a outra extremidade no conector USB da impressora.

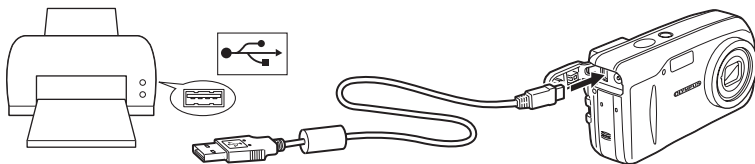

- 2 Seleccione [IMPRIMIR] no ecrã da câmara e carregue em . Depois que o ecrã [UM MOMENTO] se fechar, a câmara e e impressora estarão ligadas.

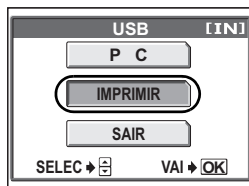

Po

Impressão directa (PictBridge) continuação...

- 3 Utilize o selector em cruz para seleccionar imagens e efectuar impressões.

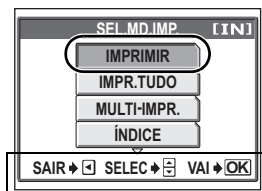

— Siga o guia de operação exibido aqui.

IMPRIMIR

IMPR. TUDO

MULTI-IMPR.

ÍNDICE

ORDEM DE IMPRESSÃO

Imprime a imagem seleccionada.

Imprime todas as imagens armazenadas na memória interna ou no cartão.

Imprime uma imagem em formato de esquema múltiplo.

Imprime um índice de todas as imagens armazenadas na memória interna ou no cartão.

Imprime as fotografias de acordo com os dados de reserva de impressão na memória interna ou no cartão. Se nenhuma reserva de impressão tiver sido feita, esta opção não estará disponível.

SOFTWARE OLYMPUS MASTER

Software OLYMPUS Master: Utilize este software para transferir imagens da câmara, visualizar, organizar, retocar, enviar por e-mail e imprimir fotografias digitais e vídeos e muito mais! Este CD inclui também um Manual do Utilizador completo do software em formato Adobe Acrobat (PDF).



Requisitos do sistema

SO	Windows 98SE/Me/2000Professional/XP ou Mac OS X (10.2 ou mais recentes)
CPU	Pentium III 500MHz / Power PC G3 500 MHz ou mais recentes
RAM	128MB ou mais (mínimo de 256MB é recomendado)
Disco rígido	300MB ou mais
Ligações	Porta USB
Ecrã	Windows : 1.024 × 768 pixeis, 65.536 cores ou mais Macintosh : 1.024 × 768 pixeis, 32.000 cores ou mais

Para obter informações de suporte mais recentes, visite o site da Web da Olympus (<http://www.olympus.com/digital>)



Registo do utilizador

Registe a sua câmara quando instalar o OLYMPUS Master para activar a sua garantia, receber notificações do software e actualizações de firmware da câmara.

ESPECIFICAÇÕES

Câmara

Tipo de produto	: Câmara Digital (para fotografar e visualizar)
Sistema de gravação	
Imagem estática	: Gravação Digital, JPEG (de acordo com o Norma de concepção para sistemas de ficheiros de câmara (DCF))
Normas aplicáveis	: Exif 2.2, Digital Print Order Format (DPOF), PRINT Image Matching III, PictBridge
Vídeo	: Suporte QuickTime Motion JPEG
Memória	: Memória interna xD-Picture Card (16 MB -1 GB)
Tamanho da imagem	: 2,816 × 2.112 pixeis (SHQ) 2,816 × 2.112 pixeis (HQ) 1,600 × 1.200 pixeis (SQ1) 640 × 480 pixeis (SQ2)
Nº de imagens graváveis (quando se utiliza o xD- Picture Card de 32 MB)	: Aprox. 7 imagens (SHQ) Aprox. 21 imagens (HQ) Aprox. 64 imagens (SQ1) Aprox. 331 imagens (SQ2)
Nº de pixeis efectivos	: Aprox. 6.000.000 pixeis
Dispositivo de captação de imagens	: CCD de 1/2,5" de captação de imagem em estado sólido, 6.370.000 pixeis (brutos)
Objectiva	: Objectiva Olympus de 6,3 a 18,9 mm, f2,8 a 4,9 (equivalente a 38 a 114 mm numa câmara de 35 mm)
Medição da luz	: Medição de ESP digital
Velocidade obturador	: 4 a 1/2.000 seg.
Amplitude de focagem	: 0,5 m a ∞ (W), 0,9 m a ∞ (T) (normal) 0,2 m a ∞ (W), 0,6 m a ∞ (T) (modo macro)
Ecrã	: Visor LCD a cores de 1,8" TFT, 85.000 pixeis
Focagem automática	: Método de detecção de contraste
Conector externo	: Entrada DC-IN, conector USB
Sistema de calendário automático	: 2005 até 2099

Ambiente de funcionamento

Temperatura	: 0°C a 40°C (funcionamento)/ -20°C a 60°C (armazenamento)
Humidade	: 30% a 90% (funcionamento)/10% a 90% (armazenamento)
Fonte de energia	: Duas pilhas oxyride, duas pilhas alcalinas ou duas pilhas de NiMH, R6 (tamanho AA)/uma bateria de lítio (CR-V3)/ adaptador de CA Olympus (opcional)
Dimensões	: 106 mm (L) x 56 mm (A) x 36 mm (P) excluindo partes salientes
Peso	: 140 g sem pilhas e cartão

O design e as especificações estão sujeitas a alterações sem aviso prévio.

xD-Picture Card

Tipo de memória : Flash NAND EEPROM

Ambiente de funcionamento

Temperatura	: 0°C a 55°C (funcionamento)/ -20°C a 65°C (funcionamento)/
Humidade	: 95% ou inferior
Energia	: 3V (3,3V)
Dimensões	: 20 x 25 x 1,7 mm

Po

PRECAUÇÕES DE SEGURANÇA



CUIDADO

NÃO ABRIR, PERIGO DE
CHOQUE ELÉCTRICO



CUIDADO: PARA REDUZIR O RISCO DE CHOQUE ELÉCTRICO, NÃO RETIRE A TAMPA (OU COSTAS), NÃO TOQUE NAS PARTES INTERNAS. CONTACTE OS SERVIÇOS TÉCNICOS QUALIFICADOS DA OLYMPUS.



O ponto de exclamação dentro de um triângulo, alerta o utilizador da presença de partes importantes para o funcionamento e de manutenção (serviços técnicos). Ver as instruções que acompanham este produto.



PERIGO

Se o produto for utilizado sem observar a informação subjacente a este símbolo, poderão resultar lesões graves ou morte.



ADVERTÊNCIA

Se o produto for utilizado sem observar a informação subjacente a este símbolo, poderão resultar lesões ou morte.



PRECAUÇÃO

Se o produto for utilizado sem observar a informação subjacente a este símbolo, poderão resultar lesões pessoais, danos no equipamento ou a perda de dados importantes.

ATENÇÃO!

PARA REDUZIR O RISCO DE FOGO OU DE CHOQUES ELÉCTRICOS, NÃO EXPONHA ESTE EQUIPAMENTO À CHUVA, EM CONTACTO COM LÍQUIDOS OU EM LOCAIS COM HUMIDADE.

Po

Precauções Gerais

Leia todas as instruções — Antes de utilizar o produto, leia todas as instruções de funcionamento. Guarde todos os manuais e instruções de segurança para futuras consultas.

Limpeza — Desligue sempre da tomada, antes de o limpar. Utilize apenas um pano macio para limpeza. Nunca use para limpar nenhum tipo de líquido ou aerossol, ou solvente orgânico.

Acessórios — Para sua segurança e evitar danos no produto, utilize apenas acessórios recomendados pela Olympus.

Água e Humidade — Para consultar as precauções sobre os produtos com características à prova de água, leia as respectivas secções.

Localização — Para evitar danos no produto, monte-o com segurança sobre um tripé, estante ou suporte estável.

Fonte de energia — Ligue este aparelho à fonte de energia designa para ele.

Relâmpagos — Se houver uma tempestade durante a utilização de um adaptador CA, desligue-o imediatamente da tomada da parede.

Objectos estranhos — Para evitar lesões pessoais, nunca insira objectos metálicos dentro do produto.

Calor — Nunca use ou guarde este produto perto de uma fonte de calor, tais como, radiador, aquecedor, ou qualquer tipo de equipamento ou ferramentas que produza calor, incluindo amplificadores de som.

Manuseamento da Câmara



ADVERTÊNCIA

- **Não utilize a câmara perto de gases inflamáveis ou explosivos.**
- **Não utilize o flash a curta distância das pessoas (especialmente crianças, adolescentes, etc.).**
 - Deverá manter-se a uma distância de no mínimo 1 m das faces dos seus sujeitos. Se disparar o flash muito próximo dos olhos do sujeito pode causar uma perda momentânea da visão.
- **Mantenha as crianças e adolescentes fora do alcance da câmara.**
 - Utilize e guarde sempre a câmara fora do alcance das crianças e menores, para prevenir as seguintes situações de perigo que poderiam causar sérias lesões:
 - Ficar preso na correia da câmara, ocasionando asfixia.
 - Ingerir acidentalmente uma pilha ou uma pequena peça.
 - Disparar o flash acidentalmente sobre os seus próprios olhos ou sobre os olhos de outra criança.
 - Lesionar-se acidentalmente com as peças móveis da câmara.
- **Não olhe para o sol ou para luzes fortes através da câmara.**
- **Não utilize nem guarde a câmara em locais com pó ou humidade.**
- **Durante o disparo, não obstrua o flash com a mão.**

Po



PRECAUÇÃO

- **Interrompa imediatamente a utilização da câmara se notar algum cheiro, ruído ou fumo estranho a sair.**
 - Nunca remova as pilhas com as mãos desprotegidas, pois pode provocar incêndio ou queimar as suas mãos.
- **Nunca segure nem opere a câmara com as mãos molhadas.**
- **Não deixar a câmara em locais onde possa estar sujeita a elevadas temperaturas.**
 - Caso contrário, as peças da câmara podem deteriorar-se e, em algumas circunstâncias, provocar incêndio na câmara. Não usar o carregador ou o adaptador de CA se estiver coberto (como com um cobertor). Caso contrário, pode provocar sobreaquecimento ou fogo.
- **Manusear a câmara com cuidado de modo a evitar uma queimadura provocada por baixas temperaturas.**
 - Quando a câmara contém peças metálicas, pode ocorrer o sobre-aquecimento das mesmas, resultando em queimaduras de baixa temperatura. Ter em atenção o seguinte:
 - Quando usada durante um longo período, a câmara ficará quente. Se continuar a segurar a câmara nesta condição, pode ocorrer uma queimadura de baixa temperatura.
 - Em locais sujeitos a temperaturas extremamente frias, a temperatura do corpo da câmara pode ser inferior à temperatura ambiente. Se possível, usar luvas ao manusear a câmara a baixas temperaturas.

PRECAUÇÕES DE SEGURANÇA continuação...

● Tenha cuidado com a correia.

- Quando transportar a câmara tenha cuidado com a correia, já que, é fácil enlaçar em objectos soltos e causar sérios danos.

Precauções a respeito da manipulação das pilhas

Siga estas importantes indicações para evitar que ocorram fugas de líquido, sobre-aquecimento, incêndio ou explosão das pilhas ou para evitar choques eléctricos ou queimaduras.



PERIGO

- Utilize somente as pilhas NiMH e o carregador apropriado de marca Olympus.
- Nunca aqueça ou queime as pilhas.
- Tome precauções ao transportar ou guardar as pilhas a fim de evitar que entrem em contacto com objectos metálicos, tais como agrafos, ganchos, jóias, etc.
- Nunca guarde as pilhas em lugares onde fiquem expostas a luz solar directa ou sujeitas a altas temperaturas ou no interior de um veículo com aquecimento, perto de uma fonte de calor, etc.
- Para evitar que ocorram fugas de líquido das pilhas ou danos dos seus terminais, siga cuidadosamente todas as instruções respectivas ao uso das pilhas. Nunca tente desmanchar a pilha nem modifica-la de nenhuma maneira, por soldadura, etc.
- Se o líquido da pilha penetrar nos seus olhos, lave-os de imediato com água corrente fresca e limpa, e procure assistência médica imediatamente.
- Guarde as pilhas sempre fora do alcance das crianças menores. Se um menor ingerir uma pilha acidentalmente, procure assistência médica imediatamente.



ADVERTÊNCIA

- Mantenha as pilhas sempre secas.
- Para evitar que ocorram fugas de líquido, sobre-aquecimento ou que provoquem incêndio ou explosão, utilize exclusivamente as pilhas recomendadas para este produto.
- Nunca misture as pilhas (novas com usadas, carregadas com descarregadas, de diferentes marcas ou capacidade, etc.).
- Nunca tente recarregar pilhas alcalinas, de lítio ou as pilhas de lítio CR-V3.
- Insira a pilha cuidadosamente conforme descrito no manual de instruções.
- Não utilize pilhas que não estão revestidas com protecção isolante ou que estão com a protecção danificada, visto que poderá ocorrer vazamento de líquido, provocar incêndio ou lesões.



PRECAUÇÃO

- Não remova as pilhas logo após desligar a câmara. As pilhas podem ficar quentes durante o uso prolongado.
- Remova a pilha da câmara sempre que for guardar a câmara por um período prolongado.

• As seguintes pilhas tipo AA (R6) não podem ser utilizadas.

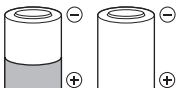

Pilhas parcialmente cobertas ou sem a cobertura da protecção isoladora.



Pilhas com os terminais \ominus em relevo, mas sem a protecção isoladora.

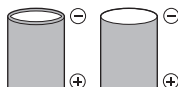

Pilhas com os terminais rasos, mas não completamente cobertos pela protecção isoladora. (Tais pilhas não podem ser utilizadas mesmo que os terminais \ominus estejam parcialmente cobertos.)

- Se as pilhas de NiMH não recarregarem dentro do tempo especificado, interrompa a recarga e não as utilize.
- Não usar uma pilha se estiver rachada ou partida.
- Se ocorrer um vazamento, descoloração ou deformação da pilha, ou qualquer outra anormalidade durante a operação, interrompa o uso da câmara.
- Se o líquido da pilha entrar em contacto com a roupa ou a pele, retire a roupa e lave de imediato a parte afectada com água corrente fresca e limpa. Se o líquido queimar a pele, solicite imediatamente cuidados médicos.
- Nunca exponha as pilhas a fortes impactos nem a vibrações contínuas.

PRECAUÇÕES DE SEGURANÇA continuação...

Para Clientes na América do Norte e do Sul

Para Clientes nos EUA

Declaração de Conformidade

Modelo Número : FE-120/X-700

Nome Comercial : OLYMPUS

Parceiro Responsável : **OLYMPUS IMAGING AMERICA INC.**

Morada : Two Corporate Center Drive, P.O. Box 9058, Melville, NY
11747-9058 EUA

Telefone Número : 1-631-844-5000

Testada Em Conformidade Com O Standard FCC

PARA USO DOMÉSTICO OU NO ESCRITÓRIO

Este aparelho está em conformidade com a Capítulo 15 das Regras FCC. O seu funcionamento está sujeito a duas condições:

- (1) Este aparelho não pode causar perigo de interferência.
- (2) Este aparelho pode receber qualquer tipo de interferência, inclusive interferências que possam originar o seu mau funcionamento.

Para Clientes no Canadá

Este aparelho digital da Classe B está em conformidade com a Regulamentação Canadiana para Equipamentos Causadores de Interferências.

Po

Marcas Comerciais

- A IBM é uma marca comercial registada da International Business Machines Corporation.
- Microsoft e Windows são marcas comerciais registadas da Microsoft Corporation.
- Macintosh é uma marca comercial registada da Apple Computers Inc.
- xD-Picture Card™ é uma marca registada.
- Todas as outras companhias e nomes de produtos são marcas comerciais registadas e/ou marcas comerciais dos respectivos fabricantes.
- Os standards referidos neste manual para os sistemas de ficheiro da câmara são os standards DCF ("Design Rule for Camera File System") estipulados pela JEITA ("Japan Electronics and Information Technology Industries Association").

MEMO

MEMO

MEMO

OLYMPUS®

<http://www.olympus.com/>

OLYMPUS IMAGING CORP.

Shinjuku Monolith, 3-1 Nishi-Shinjuku 2-chome, Shinjuku-ku, Tokyo, Japan

OLYMPUS IMAGING AMERICA INC.

Two Corporate Center Drive, P.O. Box 9058, Melville, NY 11747-9058, U.S.A. Tel. 631-844-5000

Technical Support (USA)

24/7 online automated help: <http://www.olympusamerica.com/support>

Phone customer support: Tel. 1-888-553-4448 (Toll-free)

Our phone customer support is available from 8 am to 10 pm

(Monday to Friday) ET

E-Mail: distec@olympus.com

Olympus software updates can be obtained at: <http://www.olympus.com/digital>

OLYMPUS IMAGING EUROPA GMBH

Premises: Wendenstrasse 14-18, 20097 Hamburg, Germany

Tel: +49 40-23 77 3-0 / Fax: +49 40-23 07 61

Goods delivery: Bredowstrasse 20, 22113 Hamburg, Germany

Letters: Postfach 10 49 08, 20034 Hamburg, Germany

European Technical Customer Support:

Please visit our homepage <http://www.olympus-europa.com>

or call our TOLL FREE NUMBER* : **00800 - 67 10 83 00**

for Austria, Belgium, Denmark, Finland, France, Germany, Italy, Luxemburg, Netherlands, Norway, Portugal, Spain, Sweden, Switzerland, United Kingdom

* Please note some (mobile) phone services/provider do not permit access or request an additional prefix to +800 numbers.

For all not listed European Countries and in case that you can't get connected

to the above mentioned number please make use of the following

CHARGED NUMBERS: **+49 180 5 - 67 10 83** or **+49 40 - 237 73 899**

Our Technical Customer Support is available from 9 am to 6 pm MET (Monday to Friday)