



# COLOUR TELEVISION

**CS29Z4/CS29Z6/CS29A10**

**WS32Z4/WS32Z6/WS32A10**

**CS34Z4/CS34Z6/CS34A10**

## Owner's Instructions

Before operating the unit,  
please read this manual thoroughly,  
and retain it for future reference.

**ON-SCREEN MENUS  
PICTURE IN PICTURE (OPTION)  
TELETEXT**



## Safety Instructions

ENG

- ◆ *Do not expose the television to extreme temperature conditions or to extreme humidity conditions.*
- ◆ *Do not expose the television to direct sunlight and other sources of heat.*
- ◆ *Do not expose the television to any liquids.*
- ◆ *Never put objects of any kind into the television, and do not place a water-containing vessel on the television.*
- ◆ *During a storm conditions (especially when there is lightning) unplug the television from the mains socket and aerial.*
- ◆ *Do not step on or twist the power cord.*
- ◆ *Do not overload wall outlets or extension cords as this can result in a risk of fire or electric shock.*
- ◆ *Please use a soft and dry cloth (not containing volatile matter) when you clean the TV.*
- ◆ *If the television is broken, do not try to repair it yourself. Contact qualified service personnel.*
- ◆ *If the remote control is not used for a long period of time, remove the batteries and store it in a cool, dry place.*
- ◆ *Do not drop the remote control.*

*This device is not for use in industrial environments.*

## Caution

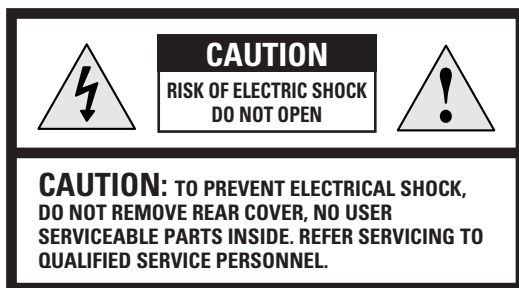

**WARNING:** TO PREVENT DAMAGE WHICH MAY RESULT IN FIRE OR SHOCK HAZARD. DO NOT EXPOSE THIS APPLIANCE TO RAIN OR MOISTURE.

The lightning flash and arrow head within the triangle is a warning sign alerting you of "dangerous voltage" inside the product.

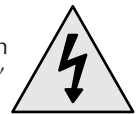

The exclamation point within the triangle is a warning sign alerting you of important instructions accompanying the product.



 *The main voltage is indicated on the rear of the TV set and the frequency is 50 or 60Hz.*

# Contents

◆ <b>FOREWORD</b>	
■ Safety Instructions .....	2
■ Caution .....	2
◆ <b>CONNECTING AND PREPARING YOUR TELEVISION</b>	
■ Control Panels (depending on the model) .....	5
■ Connection Panels (depending on the model) .....	6
■ Infrared Remote Control .....	7
■ Inserting the Batteries in the Remote Control.....	8
■ Connecting to an Aerial or Cable Television Network .....	8
■ Switching Your Television On and Off.....	9
■ Placing Your Television in Standby Mode .....	9
■ Becoming Familiar with the Remote Control .....	10
■ Plug & Play Feature.....	11
■ Viewing the Demonstration.....	12
■ Choosing Your Language.....	12
◆ <b>SETTING THE CHANNELS</b>	
■ Storing Channels Automatically.....	13
■ Storing Channels Manually.....	14
■ Skipping Unwanted Channels .....	16
■ Sorting the Stored Channels .....	17
■ Assigning Names to Channels .....	18
■ Fine Tuning Channel Reception.....	19
◆ <b>USING YOUR TELEVISION</b>	
■ Changing the Picture Standard .....	20
■ Adjusting the Picture Settings.....	21
■ Extra Picture Settings .....	22
– Digital NR	
– LNA	
– DNIe (Option)	
– Scan mode	
■ Setting the Blue Screen.....	23
■ Using the Tilt Control Feature.....	23
■ Selecting the Picture Size.....	24
■ Freezing the Current Picture .....	25
■ Changing the Sound Standard .....	25
■ Adjusting the Sound Settings .....	26

## Contents (continued)

◆ <b>USING YOUR TELEVISION</b> (continued)	
■ Extra Sound Settings .....	27
– Auto volume	
– Melody	
– Turbo sound	
– Pseudo stereo / Virtual surround	
– Woofer (Option)	
■ Selecting the Sound Mode (depending on the model) .....	28
■ Setting the Sleep Timer .....	29
■ Setting and Displaying the Current Time .....	30
■ Switching the Television On and Off Automatically .....	31
■ Viewing the Picture In Picture (PIP: Option) .....	32
◆ <b>USING THE TELETEXT FEATURE</b>	
■ Teletext Feature .....	34
■ Displaying the Teletext Information .....	34
■ Selecting a Page by Number .....	35
■ Using FLOF to Select a Page .....	36
■ Storing Teletext Pages .....	36
◆ <b>ADDITIONAL INFORMATION ON CONNECTIONS</b>	
■ Connecting to the External Input/Outputs .....	37
■ Connecting to the DVD Player .....	38
■ Connecting to the Audio Output .....	38
■ Connecting to the RCA Input .....	39
■ Connecting to the S-Video Input .....	39
■ Connecting to the PC Input (depending on the model) .....	40
■ Connecting Headphones .....	41
■ Viewing Pictures From External Sources .....	41
◆ <b>RECOMMENDATIONS FOR USE</b>	
■ Automatic Degaussing to Remove Colour Patches .....	42
■ Troubleshooting: Before Contacting Service Personnel .....	42

### Symbols



Press



Important



Note

## Control Panels (depending on the model)

➤ The actual configuration on your TV may be different, depending on your model.

ENG

**CS29Z4/WS32Z4/CS34Z4**

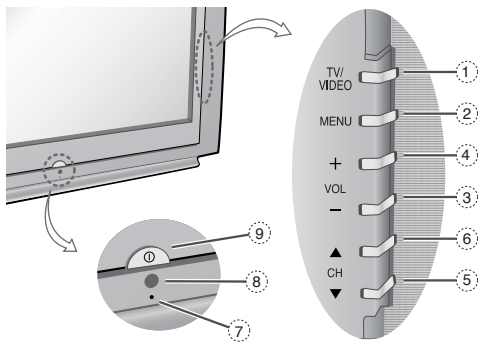

**CS29Z6/WS32Z6/CS34Z6**

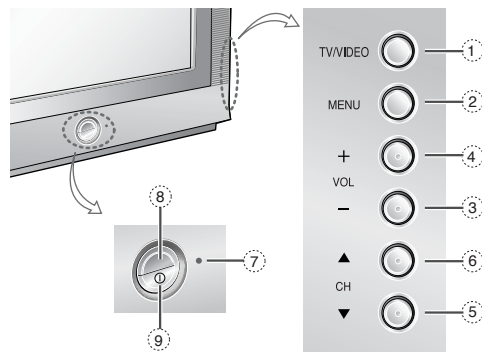

**CS29A10/WS32A10/CS34A10**

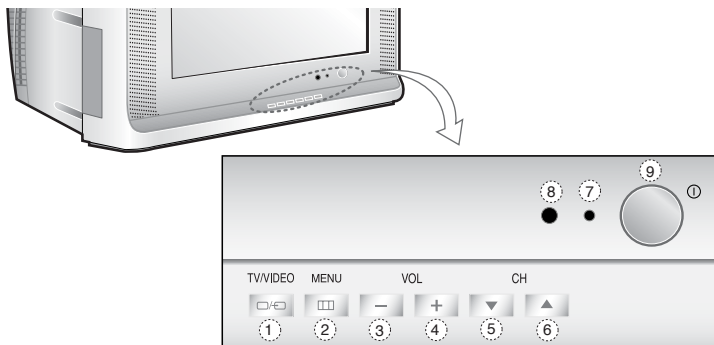

- |                          |                         |
|--------------------------|-------------------------|
| ① Input Source Selection | ⑥ Next Channel          |
| ② Menu Display           | ⑦ Standby Indicator     |
| ③ Volume Decrease        | ⑧ Remote Control Sensor |
| ④ Volume Increase        | ⑨ Power On/Off          |
| ⑤ Previous Channel       |                         |

### ➤ Using the Buttons on the Panel

If the remote control no longer works or you have lost it, you can use controls on the panel of the TV to:

- ◆ Switch on the TV when it is in Standby mode and select channels ( **▼ CH ▲** ).
- ◆ Access the menu ( **MENU** ).
- ◆ Adjust the volume ( **- VOL +** ).
- ◆ Switch among Video input modes ( **TV/VIDEO** ).

## Connection Panels (depending on the model)

➤ The actual configuration on your TV may be different, depending on your model.

### Side of the TV (depending on the model)

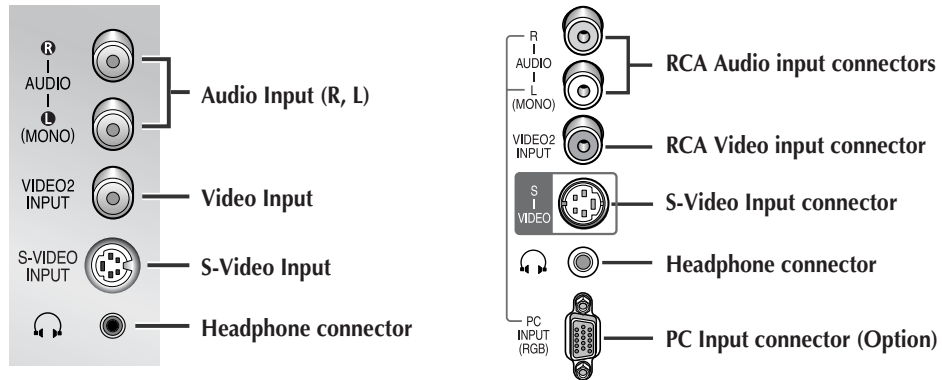

### Rear of the TV (depending on the model)

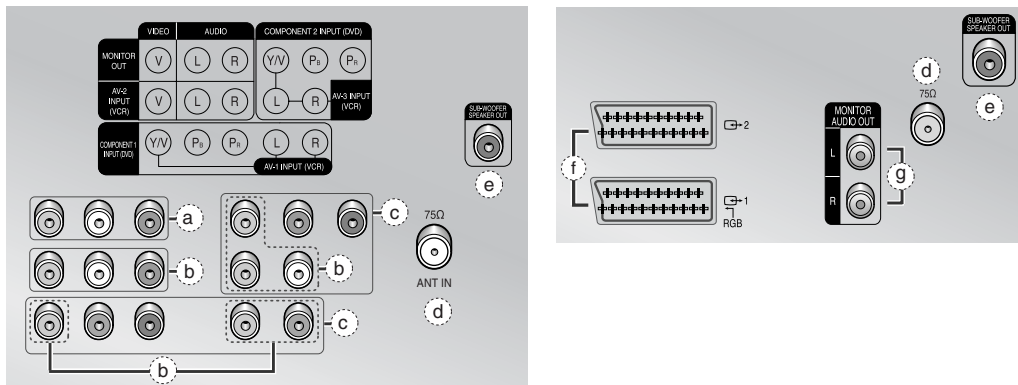

- a) **MONITOR OUT (VIDEO / AUDIO (L/R))**  
Outputs for external devices
- b) **AV 1 (VCR) -V/L/R**  
**AV 2 (VCR) -VIDEO/AUDIO (L/R)**  
**AV 3 (VCR) - V/L/R**  
Inputs or outputs for external devices, such as VCR, DVD, video game device or video disc players.
- c) **COMPONENT**  
Video (Y/Pb/Pr) and audio (L/R) inputs for Component.
- d) **VHF/UHF (75Ω)**  
75Ω Coaxial connector for Aerial/ Cable Network.
- e) **WOOFER OUT (Option)**  
Connect to the sub-woofer speaker jack.
- f) **G-2 / G-1 (SCART)**  
Inputs or outputs for external devices, such as VCR, DVD, video game device or video disc players.
- g) **MONITOR AUDIO OUT**  
Audio Output for external devices

➤ Available format for Component Inputs; 480i/576i

# Infrared Remote Control

ENG

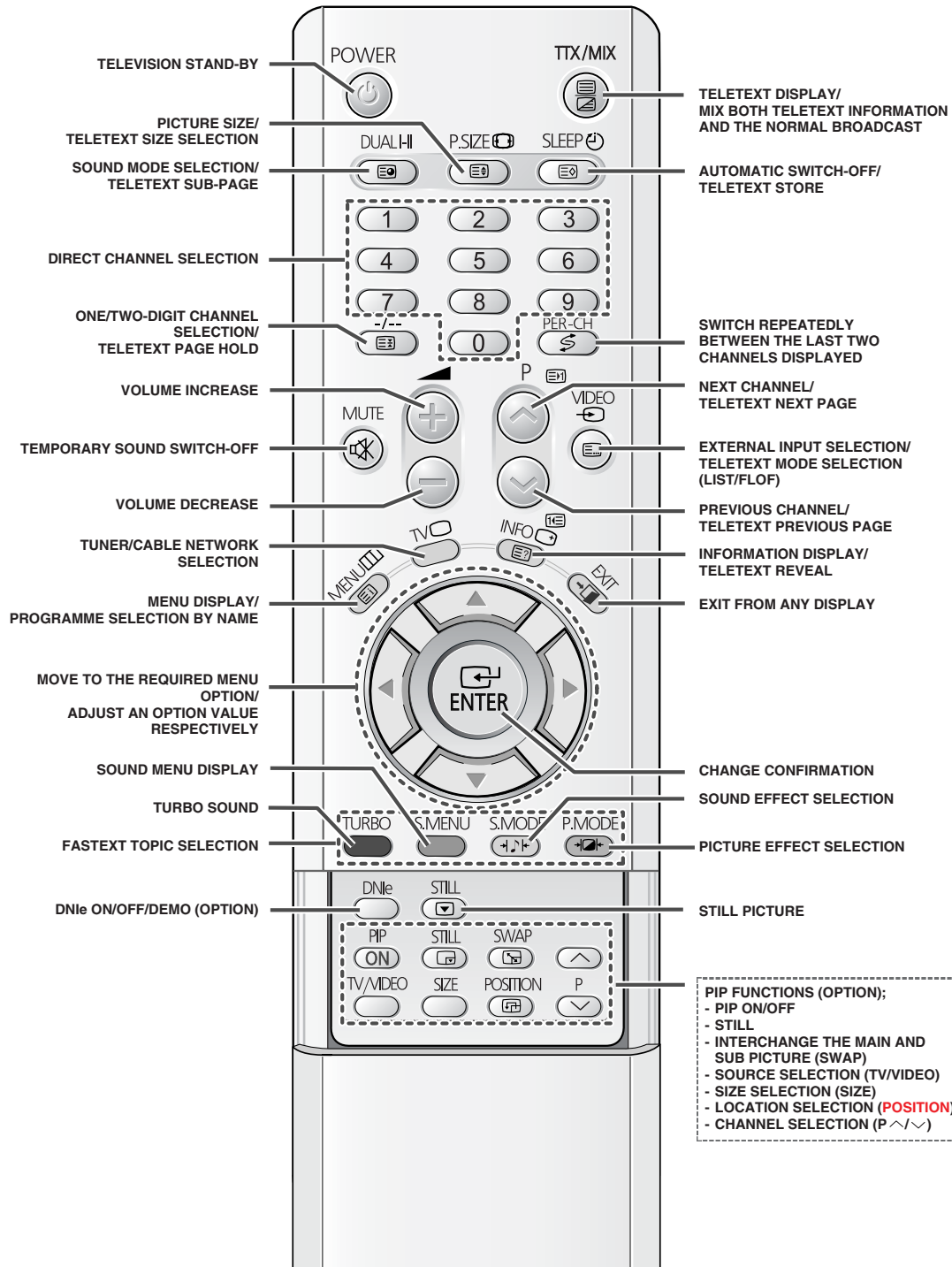

➤ The performance of the remote control may be affected by bright light.

## Inserting the Batteries in the Remote Control

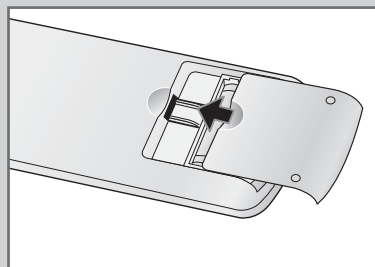
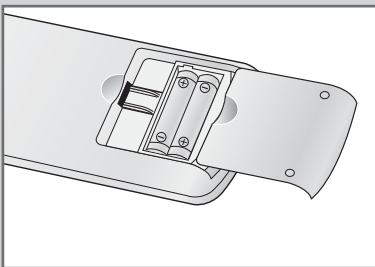
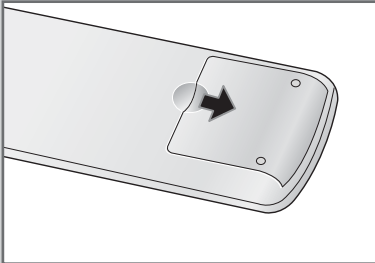

*You must insert or replace the batteries in the remote control when you:*

- ◆ *Purchase the television*
- ◆ *Find that the remote control is no longer operating correctly*

- 1 Remove the cover on the rear of the remote control by pressing the symbol (▼) downwards and then pulling firmly to remove it.
- 2 Insert two R03, UM4, "AAA" 1.5V or equivalent batteries taking care to respect the polarities:
  - ◆ - on the battery against - on the remote control
  - ◆ + on the battery against + on the remote control
- 3 Replace the cover by aligning it with the base of the remote control and pressing it back into place.

## Connecting to an Aerial or Cable Television Network

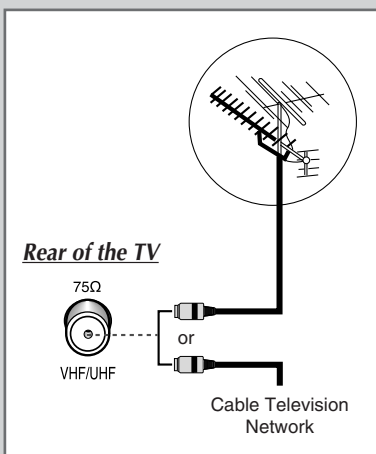

*To view television channels correctly, a signal must be received by the set from one of the following sources:*

- ◆ *An outdoor aerial*
- ◆ *A cable television network*
- ◆ *A satellite network*

- 1 In the first three cases, connect the aerial or network input cable to the 75Ω coaxial socket on the rear of the television.
- 2 If you are using an indoor aerial, you may need to turn it when tuning your television until you obtain a picture that is both sharp and clear.  
For further details, refer to:
  - ◆ "Storing Channels Automatically" on page 13.
  - ◆ "Storing Channels Manually" on page 14.



## Switching Your Television On and Off

ENG

*The mains lead is attached to the rear of your television.*

- 1 Plug the mains lead into an appropriate socket.
  - The main voltage is indicated on the rear of the television and the frequency is 50 or 60Hz.
- 2 Press the “⏻” button (On/Off) on the front of the television.

Result: The Standby indicator on the front of the television lights up.
- 3 Press the **POWER** (⏻) button on the remote control to switch the television on.

Result: The programme that you were watching last is re-selected automatically.

  - If you have not yet stored any channels, No clear picture appears. Refer to “Storing Channels Automatically” on page 13 or “Storing Channels Manually” on page 14.
- 4 To switch your television off, press the “⏻” button (On/Off) again.

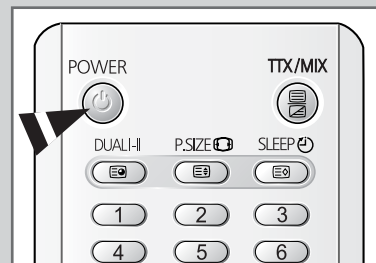

## Placing Your Television in Standby Mode

*Your television can be placed in Standby mode, in order to reduce:*

- ◆ **Power consumption**
- ◆ **Wear of the cathode ray tube**

*The Standby mode can be useful when you wish to interrupt viewing temporarily (during a meal, for example).*

- 1 Press the **POWER** (⏻) button on the remote control.

Result: The screen is turned off and the Standby indicator on the front of the television lights up in red.
- 2 To switch the television back on, simply press the **POWER** (⏻) button again.

- ☞ Do not leave your television in Standby mode for long periods of time (when you are away on holiday, for example). Turn your television off by pressing the “⏻” button (On/Off) on the front of the television. It is best to unplug the set from the mains and aerial.

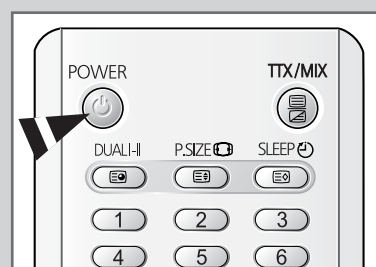

## Becoming Familiar with the Remote Control

ENG

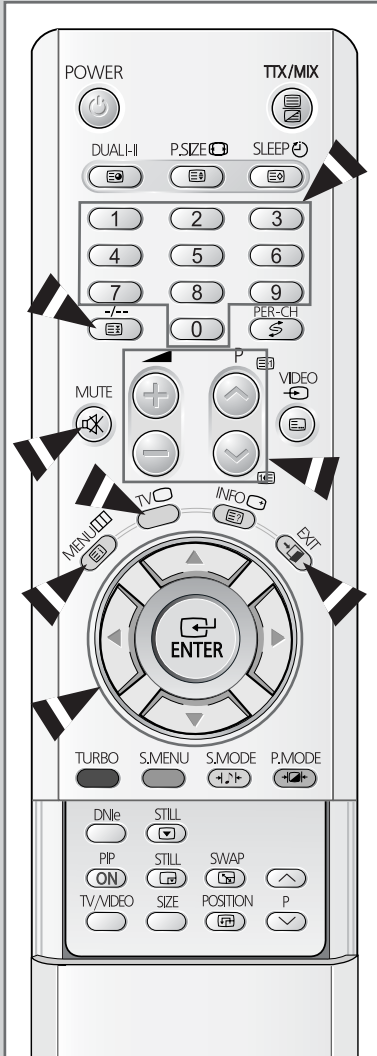

The remote control is used mainly to:

- ◆ Change channels and adjust the volume
- ◆ Set up the television using the on-screen menu system

The following table presents the most frequently used buttons and their functions.

Button	Viewing Function	Menu Function
	Used to display the next stored channel.	-
	Used to display the previous stored channel.	-
	Used to display the corresponding channels.	
	Used to select a channel numbered ten or over. Press this button, and the "--" symbol is displayed. Enter the two-digit channel number.	
	Used to increase the volume.	-
	Used to decrease the volume.	-
<b>MUTE</b>	Used to switch the sound off temporarily. ➤ To turn the sound back on, press this button again, or press the  or .	
<b>MENU</b>	Used to display the on-screen menu system.	Used to return to the previous menu or normal viewing.
	-	Used to: ◆ Display a submenu containing selections for the current menu option ◆ Increase/decrease a menu option value
	-	Used to confirm your choice.
<b>EXIT</b>	-	Used to exit from the menu system and return to normal viewing directly.
<b>TV</b>	Used to switch the television on when it is in Standby mode.	Used to exit from the menu system and return to normal viewing directly

## Plug & Play Feature

When the television is initially powered on, three basic customer settings proceed automatically and subsequently: setting the language, channel and clock.

- 1 If the television is in Standby mode, press the **POWER** ( ) button on the remote control.  
**Result:** The message **Plug & Play** is displayed. It flickers for a little while and then **Language** menu is automatically displayed. **Language** menu is depending on the country.

---
- 2 Select the appropriate language by pressing the ▼ or ▲ button. Press the **MENU** button to enter the language.  
**Result:** The message **Ant. Input : Check** is displayed.  
➤ If any language is not selected on the **Language** menu, the **Language** menu will disappear about 30 seconds later.

---
- 3 Make sure that the antenna is connected to the TV. Press the ◀ or ▶ button.  
**Result:** The **Auto store** menu is displayed with **Area** is selected.

---
- 4 Select your area by pressing the ◀ or ▶ button. To search the channels, select **Search** by pressing the ▼ or ▲ button, and then press the ◀ or ▶ button. Press the **MENU** button to stop the search.  
**Result:** The **Time** menu is displayed with **Clock** is selected.  
➤ Refer to "Storing Channels Automatically" on page 13.

---
- 5 Press the ◀ or ▶ button to move to the hour or minute. Set the hour or minute by pressing the ▼ or ▲ button.  
➤ Refer to "Setting and Displaying the Current Time" on page 30.

---
- 6 When you have finished, press the **MENU** ( ) button.  
**Result:** The message **ENJOY YOUR WATCHING** is displayed, and then the channel which has been stored will be activated.

---
- 7 **If you want to reset this feature...**
  - 1 Press the **MENU** button.

---
  - 2 Press the ▼ or ▲ button to select **Setup**, and then press the ◀ or ▶ button.  
**Result:** The **Plug & Play** is selected.

---
  - 3 Press the ◀ or ▶ button again.  
**Result:** This feature starts with the message **Plug & Play** is displayed.

Plug & Play

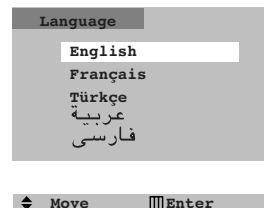

Ant. Input: Check

◀ Move Exit

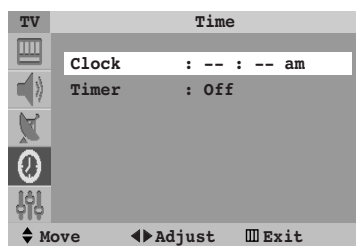
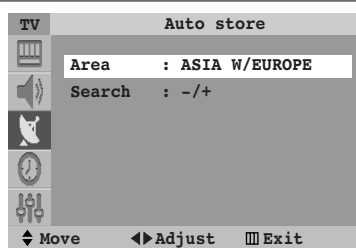

ENJOY YOUR WATCHING

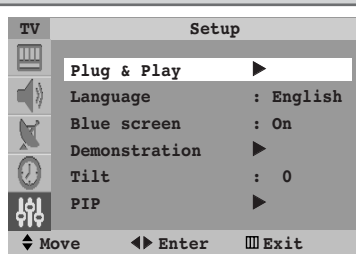

ENG

## Viewing the Demonstration

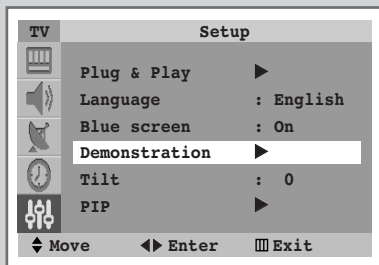
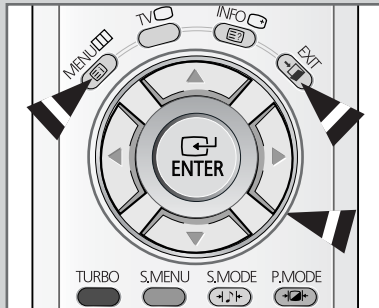

To become familiar with the various menus provided by your television, you can view the inbuilt demonstration.

- 1 Press the **MENU** button.  
Result: The main menu is displayed.
- 2 Press the ▼ or ▲ button to select **Setup**.  
Result: The options available in the **Setup** group are displayed.
- 3 Press the ◀ or ▶ button.
- 4 Press the ▼ or ▲ button to select **Demonstration**.
- 5 Press the ◀ or ▶ button.  
Result: Each of the menu options is displayed in turn.  
➤ When you wish to exit from the demonstration, press the **EXIT** (→) button on the remote control.

## Choosing Your Language

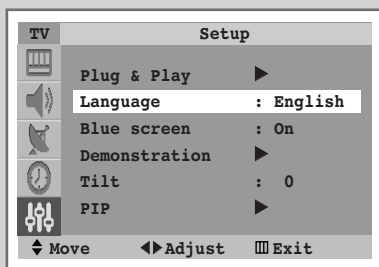

When you start using your television for the first time, you must select the language which will be used for displaying menus and indications.

- 1 Press the **MENU** button.  
Result: The main menu is displayed.
- 2 Press the ▼ or ▲ button to select **Setup**.  
Result: The options available in the **Setup** group are displayed.
- 3 Press the ◀ or ▶ button.
- 4 Press the ▼ or ▲ button to select **Language**.
- 5 Select the appropriate language by pressing the ◀ or ▶ button repeatedly.

## Storing Channels Automatically

You can scan for the frequency ranges available to you (and availability depends on your country). Automatically allocated programme numbers may not correspond to actual or desired programme numbers. However you can sort numbers manually and clear any channels you do not wish to watch.

- 1 Press the **MENU** button.  
Result: The main menu is displayed.
- 2 Press the **▼** or **▲** button to select **Channel**.  
Result: The options available in the **Channel** group are displayed.
- 3 Press the **◀** or **▶** button.  
Result: The **Auto store** is selected.
- 4 Press the **◀** or **▶** button again.  
Result: The options available in the **Auto store** group are displayed with **Area** is selected.
- 5 Select your area by pressing the **◀** or **▶** button. The areas are displayed in the following order: **ASIA W/EUROPE - CIS E/EUROPE - CHINA - HONGKONG U/K - AUSTRALIA - NZ/INDONESIA - SOUTH AFRICA - AMERICA**
- 6 Press the **▼** or **▲** button to select **Search**.
- 7 Press the **◀** or **▶** button to start the search.  
Result: The horizontal bar is displayed, and then channels are stored in an order which reflects their positions in the frequency range. Finally, the search will end automatically.
  - To stop the search before it has finished, press the **MENU** (**□□□**) button.
- 8 When searching and storing are complete, the **Sort** menu is displayed.
  - ◆ To sort the stored channels into the desired numerical order, go to Step 6 of the "Sorting the Stored Channels" procedure on page 17.
  - ◆ To exit from the channel store function without sorting the channels, press the **MENU** (**□□□**) button repeatedly until the menus disappear.
- 9 When the channels have been stored, you can:
  - ◆ Sort them in the order required (refer to page 17)
  - ◆ Clear a channel (refer to page 16)
  - ◆ Assign a name to the stored channels (refer to page 18)
  - ◆ Fine tune channel reception if necessary (refer to page 19)
  - ◆ Activate the Digital Noise Reduction feature (refer to page 22)

ENG

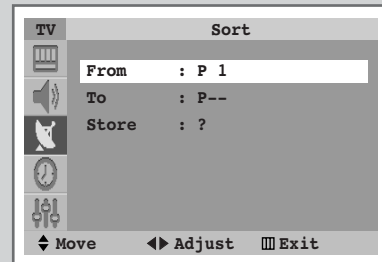
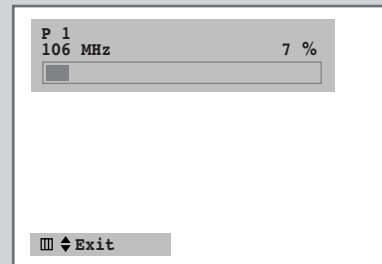
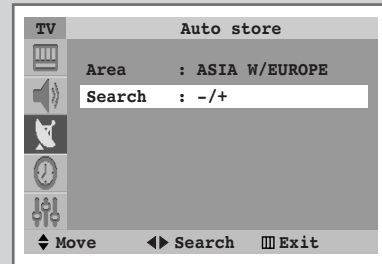
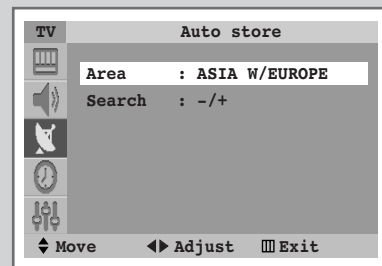
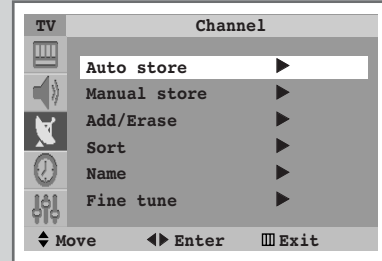

## Storing Channels Manually

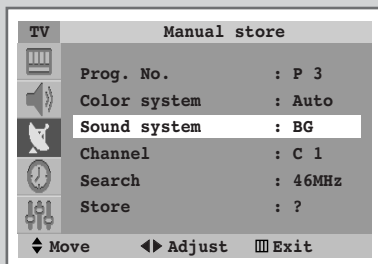
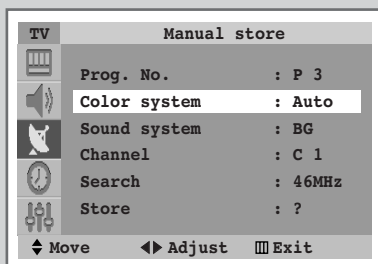
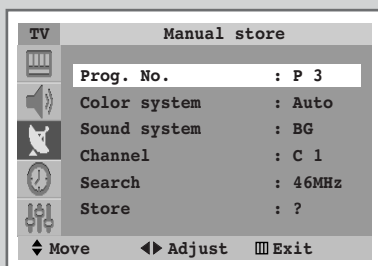
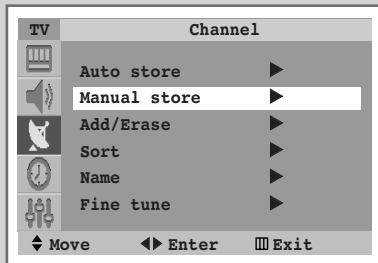

You can store the channels, including those received via cable networks.

When storing channels manually, you can choose:

- ◆ Whether or not to store each of the channels found
- ◆ The programme number of each stored channel which you wish to identify

- 1 Press the **MENU** button.  
Result: The main menu is displayed.

---

- 2 Press the ▼ or ▲ button to select **Channel**.  
Result: The options available in the **Channel** group are displayed.

---

- 3 Press the ◀ or ▶ button.

---

- 4 Press the ▼ or ▲ button to select **Manual store**.

---

- 5 Press the ◀ or ▶ button.  
Result: The options available in the **Manual store** group are displayed with **Prog. No.** is selected.

---

- 6 To assign a programme number to a channel, press the ◀ or ▶ button.

---

- 7 Press the ▼ or ▲ button to select **Color system**. Indicate the broadcasting standard required by pressing the ◀ or ▶ button repeatedly.  
Result: The color standards are displayed in the following order:  
**Auto - PAL - SECAM - NT4.43 - NT3.58.**

---

- 8 Press the ▼ or ▲ button to select **Sound system**. Select the sound standard required by pressing the ◀ or ▶ button repeatedly.  
Result: The sound standards are displayed in the following order:  
**BG - DK - I - M.**

## Storing Channels Manually (continued)

ENG

- 9** If you know the number of the channel to be stored, see the following steps.
- ◆ Press the ▼ or ▲ button to select **Channel**.
  - ◆ Press the ► button.
  - ◆ Press the ▼ or ▲ button to select **C** (Air channel) or **S** (Cable channel).
  - ◆ Press the ► button.
  - ◆ Press the ▼ or ▲ button to select indicate the required number.
    - You can also select the channel number directly by pressing the numeric buttons (0~9).
    - If no sound or abnormal sound, re-select the sound standard required.
- 10** If you do not know the channel numbers, select **Search** by pressing the ▼ or ▲ button. Press the ◀ or ▶ button to start the search.
- Result: The tuner scans the frequency range until the first channel or the channel that you selected is received on your screen.
- 11** To store the channel and associated programme number, select **Store** by pressing the ▼ or ▲ button. Press the ◀ or ▶ button to select **OK**.
- 12** Repeat Steps 9 to 11 for each channel to be stored.

### Channel mode

- ◆ **P** (Programme mode): When completing tuning, the broadcasting stations in your area have been assigned to position numbers from P00 to max P99. You can select a channel by entering the position number in this mode.
- ◆ **C** (Real channel mode): You can select a channel by entering the assigned number to each air broadcasting station in this mode.
- ◆ **S** (Cable channel mode): You can select a channel by entering the assigned number for each cable channel in this mode.

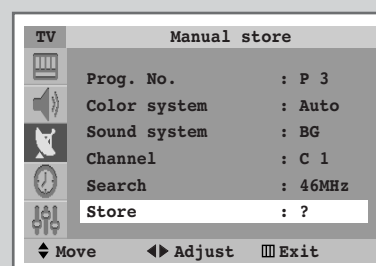
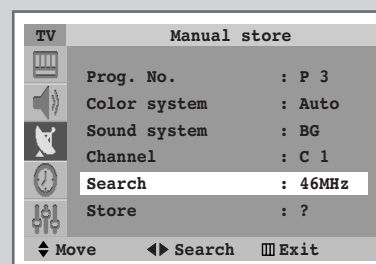
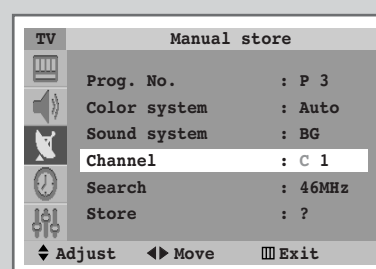

## Skipping Unwanted Channels

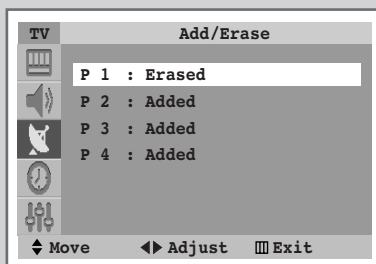
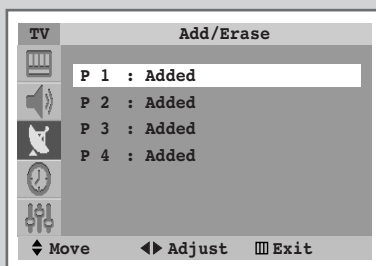
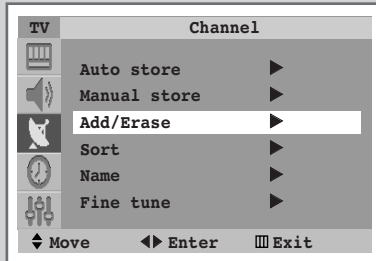

*You can exclude the channels you chosen from the channels you scanned. When you scan through the stored channels, those you have chosen to skip are not displayed.*

*All of the channels that you do not specifically choose to skip are displayed during scanning.*

- 1 Press the **MENU** button.  
Result: The main menu is displayed.
- 2 Press the ▼ or ▲ button to select **Channel1**.  
Result: The options available in the **Channel1** group are displayed.
- 3 Press the ◀ or ▶ button.
- 4 Press the ▼ or ▲ button to select **Add/Erase**.
- 5 Press the ◀ or ▶ button.  
Result: The stored channels are displayed.
- 6 Press the ▼ or ▲ button to select the channel to add or erase. If necessary, select **Added** or **Erased** by pressing the ◀ or ▶ button.
- 7 Repeat Step 6 for each channel to be added or erased.



## Sorting the Stored Channels

*This operation allows you to change the programme numbers of stored channels. This operation may be necessary after using auto store. You can delete the channels you do not want to keep.*

- 1 Press the **MENU** button.  
Result: The main menu is displayed.
- 2 Press the **▼** or **▲** button to select **Channel**.  
Result: The options available in the **Channel** group are displayed.
- 3 Press the **◀** or **▶** button.
- 4 Press the **▼** or **▲** button to select **Sort**.
- 5 Press the **◀** or **▶** button.  
Result: The options available in the **Sort** group are displayed with **From** is selected.
- 6 Select the channel number that you wish to change by pressing the **◀** or **▶** button repeatedly.
- 7 Press the **▼** or **▲** button to select **To**. Select the new channel number which you wish to identify by pressing the **◀** or **▶** button repeatedly.  
➤ You can also select the channel number directly by pressing the numeric buttons (0~9).
- 8 Press the **▼** or **▲** button to select **Store**. Select **OK** to confirm the exchange of channel numbers by pressing the **◀** or **▶** button.  
Result: The selected channel is exchanged with the one previously stored to the chosen number.
- 9 For all the channels to move to the required channel numbers, repeat steps **6** to **8** after selecting the **From** by pressing the **▼** or **▲** button.

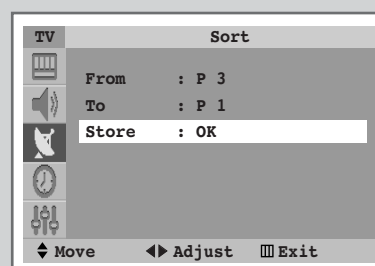
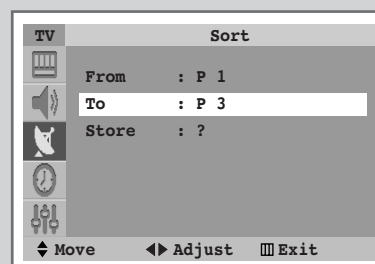
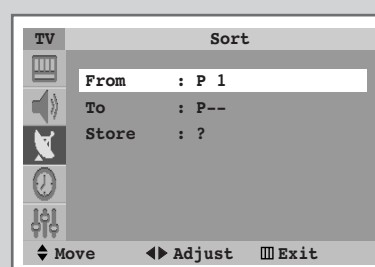
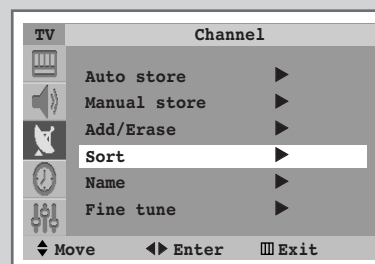

## Assigning Names to Channels

ENG

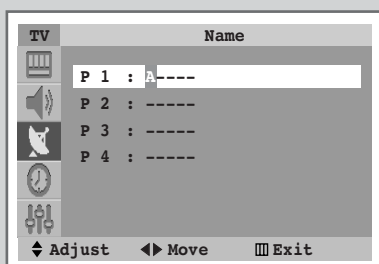
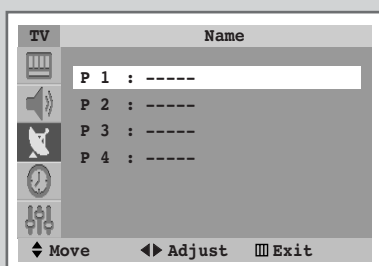
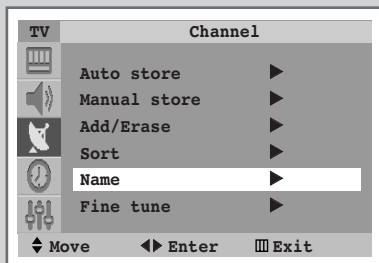

*Channel names will be assigned automatically when channel information is broadcast. These names can be changed, allowing you to assign new names.*

- 1 Press the **MENU** button.  
Result: The main menu is displayed.
- 2 Press the **▼** or **▲** button to select **Channel1**.  
Result: The options available in the **Channel1** group are displayed.
- 3 Press the **◀** or **▶** button.
- 4 Press the **▼** or **▲** button to select **Name**.
- 5 Press the **◀** or **▶** button.  
Result: The current channels are displayed.
- 6 If necessary, select the channel to be assigned to a new name by pressing the **▼** or **▲** button.
- 7 Press the **◀** or **▶** button.
- 8 Press the **▼** or **▲** button to select a letter (A~Z), a number (0~9) or a symbol (-, space). Move on the previous or next letter by pressing the **◀** or **▶** button.
- 9 Repeat Steps 6 to 8 for each channel to be assigned to a new name.

## Fine Tuning Channel Reception

ENG

*If the reception is clear, you do not have to fine tune the channel, as this is done automatically during the search and store operation. If the signal is weak or distorted, you may have to fine tune the channel manually.*

- 1 Press the **MENU** button.  
Result: The main menu is displayed.
- 2 Press the ▼ or ▲ button to select **Channel**.  
Result: The options available in the **Channel** group are displayed.
- 3 Press the ◀ or ▶ button.
- 4 Press the ▼ or ▲ button to select **Fine tune**.
- 5 Press the ◀ or ▶ button.  
Result: The options available in the **Fine tune** group are displayed with **Tune** is selected.
- 6 To obtain a sharp and clear picture and good sound quality, press the ◀ or ▶ button.  
Result: The horizontal bar is displayed. Move the horizontal bar's cursor left or right by pressing the ◀ or ▶ button.
- 7 To memorise adjusted picture or sound, select **Store** by pressing the ▼ or ▲ button. Press the ◀ or ▶ button.  
Result: **OK** is displayed.
- 8 To erase adjusted picture or sound, select **Erase** by pressing the ▼ or ▲ button. Press the ◀ or ▶ button.  
Result: **OK** is displayed.

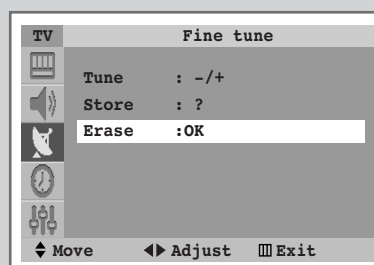
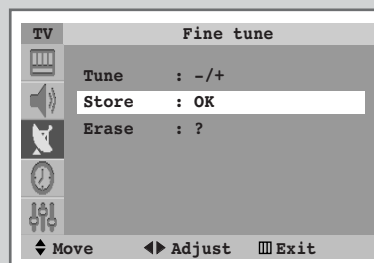
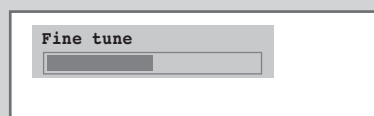
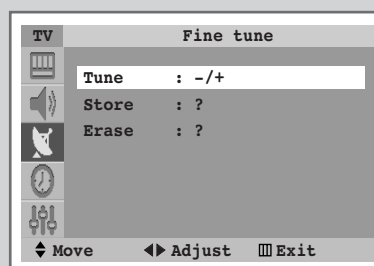
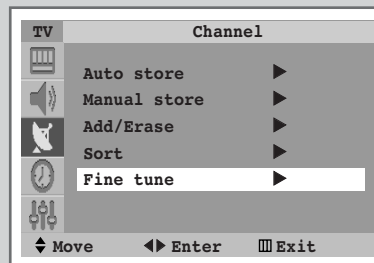

## Changing the Picture Standard

ENG

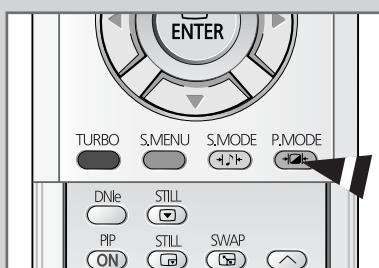
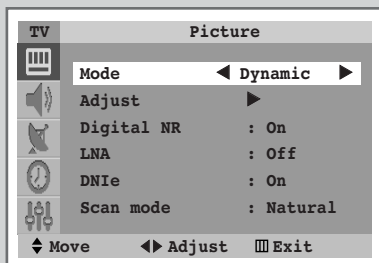

You can select the type of picture which best corresponds to your viewing requirements.

1 Press the **MENU** button.

Result: The options available in the **Picture** group are displayed.

2 Press the ◀ or ▶ button.

Result: The **Mode** is selected.

3 Select the required picture effect by pressing the ◀ or ▶ button repeatedly.

Result: The following picture effects are available:  
**Dynamic – Standard – Movie – Custom.**

➤ You can also set these options simply by pressing the **P.MODE** (Picture Mode) button.

## Adjusting the Picture Settings

ENG

Your television has several settings which allow you to control picture quality.

- 1 Press the **MENU** button.  
Result: The options available in the **Picture** group are displayed.
- 2 Press the ◀ or ▶ button.
- 3 Press the ▼ or ▲ button to select **Adjust**.
- 4 Press the ◀ or ▶ button.  
Result: The options available in the **Adjust** group are displayed.
- 5 Press the ▼ or ▲ button to select the option (**Contrast**, **Brightness**, **Sharpness**, **Color**, **Color tone** or **Tint**-NTSC only) to be adjusted. Press the ◀ or ▶ button.  
Result: The horizontal bar is displayed. Move the horizontal bar's cursor left or right by pressing the ◀ or ▶ button.

- 
- ◆ If you make any changes to these settings, the picture standard is automatically switched to **Custom**.
  - ◆ The television has an "automatic degaussing" system that is activated if magnetic interference is present. To degauss the television screen, switch power off by pressing the "Ⓚ" (On/Off) button on the front panel. (Refer to "Automatic Degaussing to Remove Colour Patches" on page 42.)

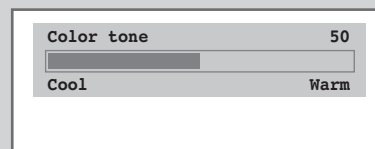
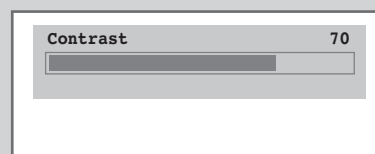
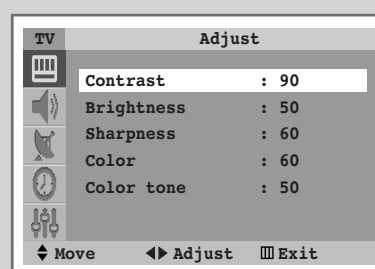
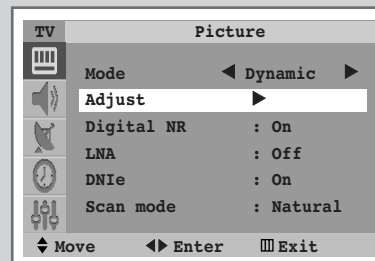

## Extra Picture Settings

ENG

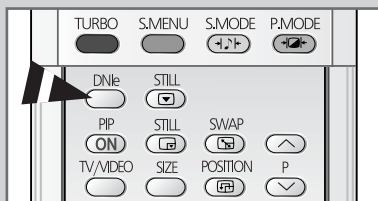
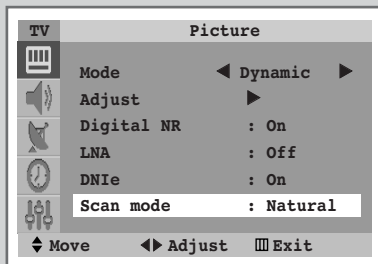
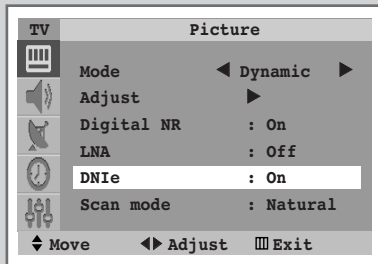
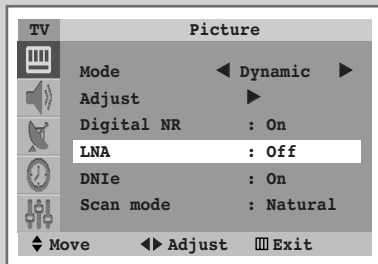
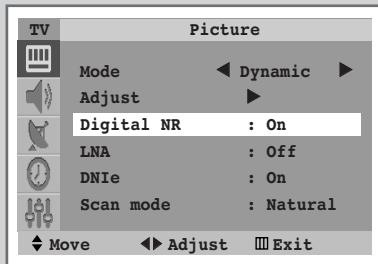

### ◆ Digital NR

If the signal received by your television is weak, you can activate this feature to reduce any static and ghosting that may appear on the screen.

### ◆ LNA (Low Noise Amplifier)

This function is very useful in the situation that the TV is used in weak signal. LNA amplifies the TV signal in the weak signal area, but not noise. This feature is working only weak signal condition, and that is memorized on current channel, additional.

### ◆ DNIE (Digital Natural Image engine DNIE™) : Option

This feature bring you more detailed image with 3D noise reduction, detail enhancement, contrast enhancement and white enhancement. New image compensation Algorithm gives brighter, clearer, much detailed image to you. DNIE™ technology will fit every signals into your eyes.

### ◆ Scan mode

You will normally find that scan mode is best set to **Natural** to reduce any slight picture flicker. However, it is possible that some occasional broadcasts (NTSC-M) may benefit by changing the scan mode. **Natural**, **Digital** and **Progressive** modes are available.

- 1 Press the **MENU** button.  
Result: The options available in the **Picture** group are displayed.
- 2 Press the ◀ or ▶ button.
- 3 Select the required option (**Digital NR**, **LNA**, **DNIE** (Option) or **Scan mode**) by pressing the ▼ or ▲ button.
- 4 Press the ◀ or ▶ button to change the setting.
  - ◆ **Digital NR** : Off or On (activating)
  - ◆ **LNA** : Off or On (activating)
  - ◆ **DNIE** (Option) : Off, Demo or On (activating)
    - You can also set these options simply by pressing the **DNIE** button. (depending on the model)
  - ◆ **Scan mode** : Natural, Digital or Progressive

## Setting the Blue Screen

*If no signal is being received or the signal is very weak, a blue screen automatically replaces the noisy picture background.*

*If you wish to continue viewing the poor picture, you must set the "Blue Screen" mode to "Off".*

- 1 Press the **MENU** button.  
Result: The main menu is displayed.
- 2 Press the ▼ or ▲ button to select **Setup**.  
Result: The options available in the **Setup** group are displayed.
- 3 Press the ◀ or ▶ button.
- 4 Press the ▼ or ▲ button to select **Blue screen**.
- 5 To activate this feature, select **On** by pressing the ◀ or ▶ button.

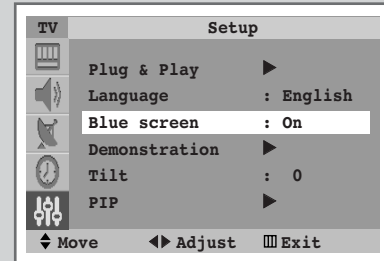

## Using the Tilt Control Feature

*If you find that the picture received is slightly tilted to one side, you can adjust the tilt setting.*

- 1 Press the **MENU** button.  
Result: The main menu is displayed.
- 2 Press the ▼ or ▲ button to select **Setup**.  
Result: The options available in the **Setup** group are displayed.
- 3 Press the ◀ or ▶ button.
- 4 Press the ▼ or ▲ button to select **Tilt**.
- 5 Press the ◀ or ▶ button to reach the required setting (-7 to +7).

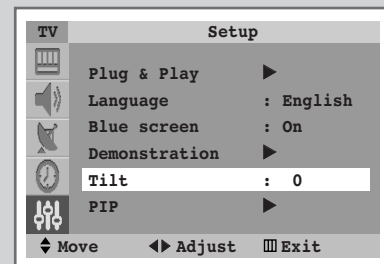

## Selecting the Picture Size

ENG

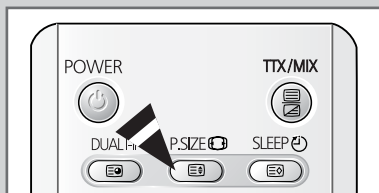

You can select the picture size which best corresponds to your viewing requirements simply by pressing the "P.SIZE (P)" button. The following picture sizes are available:

- ◆ Normal, Zoom1, Zoom2, 16:9
- ◆ Wide, Panorama, Zoom1, Zoom2, 4:3

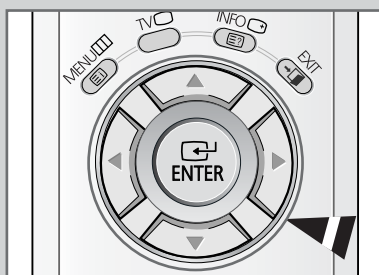

- If the PC is connected, you can adjust the **Size** and **Position** of PC mode by pressing the button. (depending on the model)

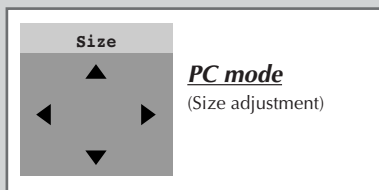
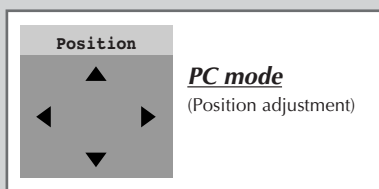



## Freezing the Current Picture

You can freeze the picture when watching a television programme simply by pressing the "STILL (▾)" button.

- To return to normal viewing, press this button again.

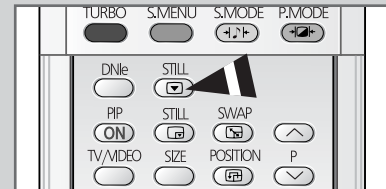

## Changing the Sound Standard

You can select the type of special sound effect to be used when watching a given broadcast.

- 1 Press the **MENU** button.  
Result: The main menu is displayed.

---

- 2 Press the **▼** or **▲** button to select **Sound**.  
Result: The options available in the **Sound** group are displayed.

---

- 3 Press the **◀** or **▶** button.  
Result: The **Mode** is selected.

---

- 4 Select the required sound effect by pressing the **◀** or **▶** button repeatedly.  
Result: The following sound effects are available:  
**Standard - Music - Movie - Speech (SVE) - Custom.**  
◆ **SVE** : **SAMSUNG Voice Enhancement Technic**

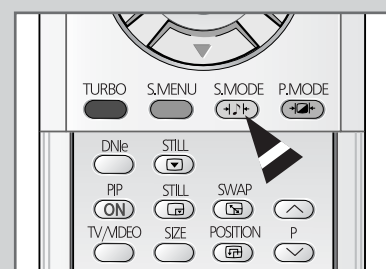
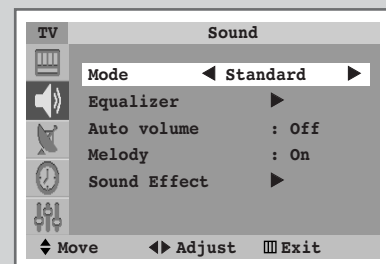

- You can also set these options simply by pressing the **S.MODE** (Sound Mode) button.

## Adjusting the Sound Settings

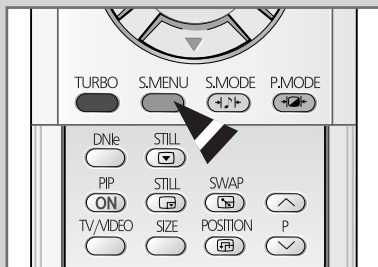
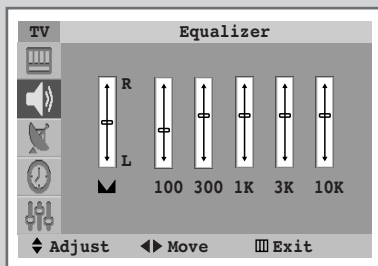
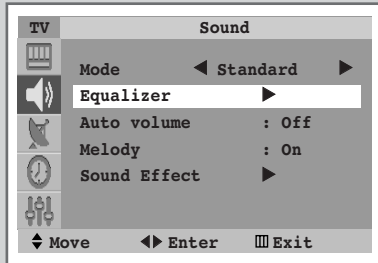

The sound settings can be adjusted to suit your personal preferences.

- 1 Press the **MENU** button.  
Result: The main menu is displayed.

---

- 2 Press the **▼** or **▲** button to select **Sound**.  
Result: The options available in the **Sound** group are displayed.

---

- 3 Press the **◀** or **▶** button.

---

- 4 Press the **▼** or **▲** button to select **Equalizer**.

---

- 5 Press the **◀** or **▶** button.  
Result: The options available in the **Equalizer** group are displayed.  
➤ You can also display this group simply by pressing the **S.MENU** (Sound Menu) button.

---

- 6 Select the option to be adjusted by pressing the **◀** or **▶** button. Press the **▼** or **▲** button to reach the required setting.

➤ If you make any changes to these settings, the sound standard is automatically switched to **Custom**.

## Extra Sound Settings

ENG

### ◆ **Auto volume**

Each broadcasting station has its own signal conditions, and so it is not easy for you to adjust the volume every time the channel is changed. This feature lets you automatically adjust the volume of the desired channel by lowering the sound output when the modulation signal is high or by raising the sound output when the modulation signal is low.

### ◆ **Melody**

You can hear clear melody sound when the television is powered on or off.

### ◆ **Turbo sound**

This feature suitably emphasizes both higher and lower bands of sound (and includes other effects). You can enjoy more magnificent and dynamic sound when watching music, movie, or other channels.

### ◆ **Pseudo stereo / Virtual surround**

**Pseudo stereo** feature converts a monaural sound signal into two identical left and right channels.

Once the **Pseudo stereo** or **Virtual surround** is set to **On** or **Off**, these settings apply to the sound effects such as **Standard**, **Music**, **Movie**, and **Speech (SVE)**.

### ◆ **Woofer (Option)**

This Woofer plays signals below 160Hz in the 20Hz~20KHz frequency. It improves listening to music and watching movies.

- 1 Press the **MENU** button.  
Result: The main menu is displayed.
- 2 Press the **▲** or **▼** button to select **Sound**.  
Result: The options available in the **Sound** group are displayed.
- 3 Press the **◀** or **▶** button.
- 4 Select the required option (**Auto volume**, **Melody**, **Turbo sound**, **Pseudo stereo**, **Virtual surround** or **Woofer (Option)**) by pressing the **▼** or **▲** button.
  - To select **Turbo sound**, **Pseudo stereo** and **Virtual surround** or **Woofer (Option)** select **Sound effect** by pressing the **▼** or **▲** button and press the **◀** or **▶** button.
  - You can select the turbo sound feature simply by pressing the **TURBO** button.
- 5 To activate each feature, select **On** by pressing the **◀** or **▶** button.

- Manufactured under license from Dolby Laboratories. "Dolby" and the double-D symbol (DD) are trademarks of Dolby Laboratories.

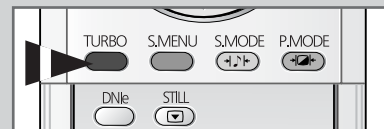
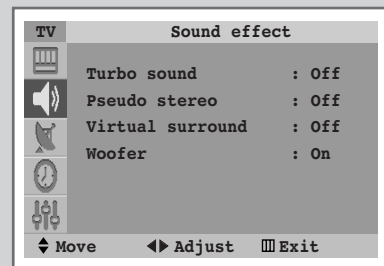
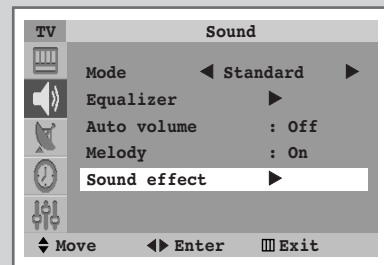
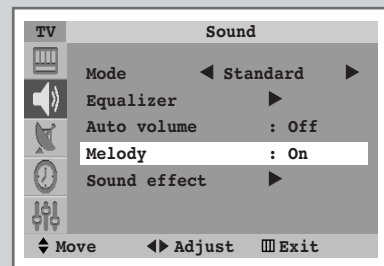
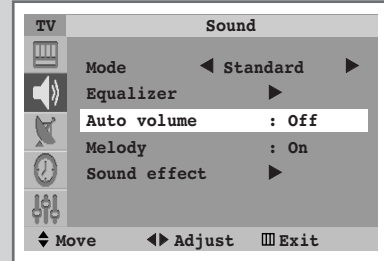

## Selecting the Sound Mode (depending on the model)

ENG

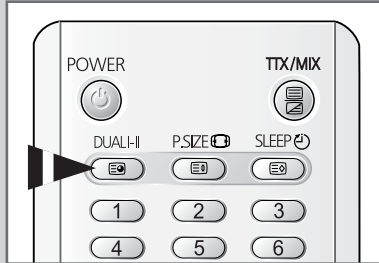

The "DUAL II" button displays/controls the processing and output of the audio signal. When power is switched on, the mode is automatically preset to either "Dual-I" or "Stereo", depending on the current transmission.

	Type of broadcast	On-screen indication
<b>NICAM Stereo</b>	Regular broadcast (Standard audio)	<b>Mono</b> (Normal use)
	Regular + NICAM Mono	<b>Mono NICAM</b> ↔ <b>Mono</b> (Normal)
	NICAM Stereo	<b>Stereo NICAM</b> ↔ <b>Mono</b> (Normal)
	NICAM Dual-I/II	<b>Dual-I NICAM</b> → <b>Dual-II NICAM</b> → <b>Mono</b> (Normal) ↑—————↓
<b>A2 Stereo</b>	Regular broadcast (Standard audio)	<b>Mono</b> (Normal use)
	Bilingual or Dual-I/II	<b>DUAL-I</b> ↔ <b>DUAL-II</b>
	Stereo	<b>Stereo</b> ↔ <b>Mono</b> (Forced mono)

- ◆ If the receiving conditions deteriorate, listening will be easier if the mode is set to the **Mono**.
- ◆ If the stereo signal is weak and an automatic switching occurs, then switch to the **Mono**.
- ◆ When receiving a mono sound in the AV mode, connect to the "AUDIO-L" input connector on the panel (front or side). If the mono sound comes out only from left speaker, press the **DUAL II** button.

## Setting the Sleep Timer

You can select a time period of between 30 and 180 minutes after the television automatically switches to Standby mode by pressing the "SLEEP (⏻)" button.

- 1 Press the **SLEEP (⏻)** button on the remote control.  
Result: If the sleep timer is not yet set, **Off** is displayed. If the sleep timer is already set, the screen displays the remaining time and then before the television will be placed in standby mode.
- 2 Press the **SLEEP (⏻)** button repeatedly and cycle through the preset time intervals (30, 60, 90, 120, 150, 180).  
Result: The television automatically switches to standby mode when the timer reaches 0.
- 3 To cancel the sleep timer feature, press the **SLEEP (⏻)** button repeatedly and select **Off**.

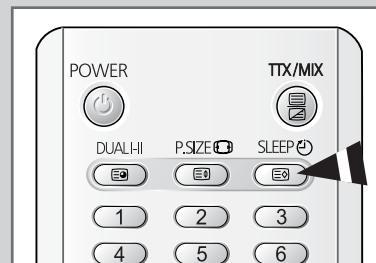

ENG

## Setting and Displaying the Current Time

ENG

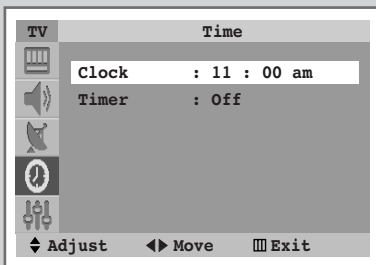
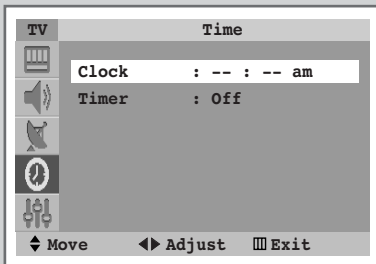

You can set the television's clock so that the current time is displayed by pressing the "INFO ( )" button. You must also set the time if you wish to use the automatic on or off timers.

➤ When pressing the "Ⓚ" button (On/Off) on the front of the television, the clock setting will be reset.

- 1 Press the **MENU** button.  
Result: The main menu is displayed.
- 2 Press the ▼ or ▲ button to select **Time**.  
Result: The options available in the **Time** group are displayed.
- 3 Press the ◀ or ▶ button.  
Result: The **Clock** is selected.
- 4 Press the ◀ or ▶ button to move to the hour or minute. Set the hour or minute by pressing the ▼ or ▲ button.
- 5 When you have finished, press the **TV** button to exit.
- 6 **To...** **Press the "INFO ( )" button...**

display the channel information	Once.
display the current time	Twice.
remove the display	Three times.

## Switching the Television On and Off Automatically

ENG

You can set the On/Off timers so that the television will:

- ◆ Switch on automatically and tune to the channel of your choice at the time you select
- ◆ Switch off automatically at the time you select

➤ The first step is to set the television's clock (refer to "Setting and Displaying the Current Time" on the previous page). If you have not yet set the clock, the message **Set the clock first** is displayed.

- 1 Press the **MENU** button.  
Result: The main menu is displayed.
- 2 Press the ▼ or ▲ button to select **Time**.  
Result: The options available in the **Time** group are displayed.
- 3 Press the ◀ or ▶ button.
- 4 Press the ▼ or ▲ button to select **Timer**.
- 5 Press the ◀ or ▶ button to set to **On**  
Result: The **On time** and **Off time** are displayed.
- 6 Press the ▼ or ▲ button to select **On time**. Set the time at which you wish the television to be switched on automatically.
  - ◆ Press the ◀ or ▶ button to move to the hour or minute. Set these by pressing the ▼ or ▲ button.
- 7 Press the ▼ or ▲ button to select **Off time**. In the same above, set the time at which you wish the television to be switched off automatically.

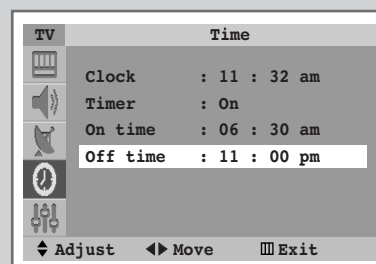
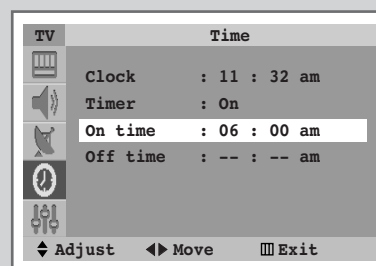
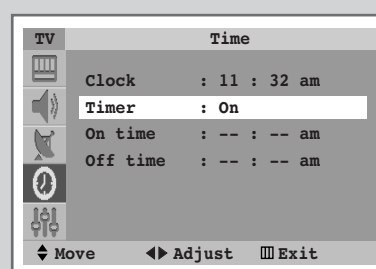
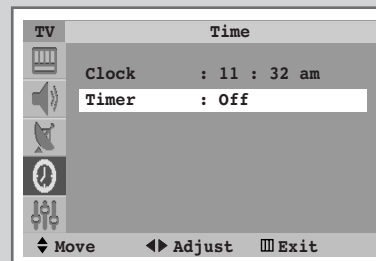

## Viewing the Picture In Picture (PIP) (Option)

ENG

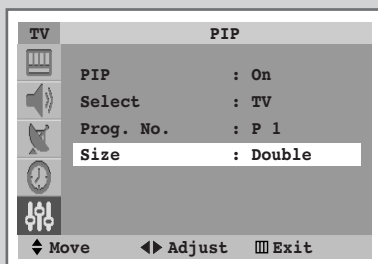
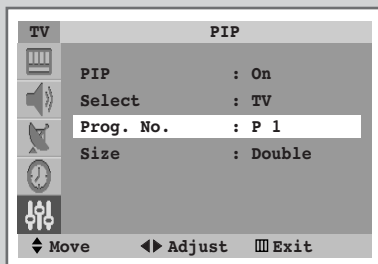
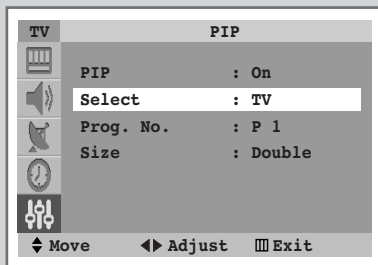
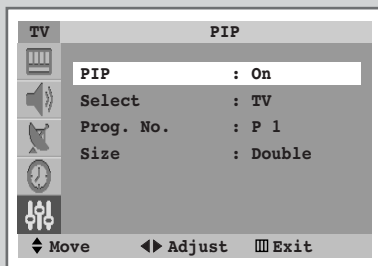
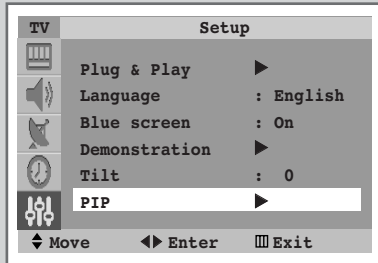

You can display a sub picture within the main picture of TV program or external A/V devices such as VCR or DVD. In this way you can watch TV program or monitor the video input from any connected devices while watching TV or other video input.

- Press the **MENU** button.  
Result: The main menu is displayed.
- Press the ▼ or ▲ button to select **Setup**.  
Result: The options available in the **Setup** group are displayed.
- Press the ◀ or ▶ button.
- Press the ▼ or ▲ button to select **PIP**. Press the ◀ or ▶ button.
- Press the ◀ or ▶ button again to set to **On**.  
Result: The options available in the **PIP** group are displayed.
- Press the ▼ or ▲ button to select **Select**. Find a source of sub picture by pressing the ◀ or ▶ button.  
Result: The sources are displayed in the following order:  
**TV - AV1 - AV2 - AV3 - S-VIDEO.**  
 (RCA Model: Option)  
**TV - AV1 - AV2 - S-VIDEO.**  
 (SCART: Option)
- Press the ▼ or ▲ button to select **Prog.No.**. If you are watching TV program, select the channel that you want to view through a sub picture by pressing the ◀ or ▶ button.  
 ➤ When the source of the sub picture (**Select**) is set to **TV**, you can select the channel of the sub picture.
- Press the ▼ or ▲ button to select **Size**. Select a size of sub picture by pressing the ◀ or ▶ button.  
Result: The sizes are displayed in the following order:  
**Double - Large - Small - 16 PIP.**  
 ➤ ◆ **16 PIP** : You can view up to 16 memorized channels on the sub picture spontaneously.  
 ◆ On the condition of **16 PIP**, it is impossible to execute swap, still and locate.



## Viewing the Picture In Picture (PIP) (continued)

ENG

### Easy functions of remote control

Buttons	Feature
<b>PIP ON</b>	Used to activate or deactivate the PIP function directly.
<b>STILL</b>	Used to freeze the sub picture.
<b>SWAP</b>	Used to interchange the main picture and the sub picture. ➤ When the main picture is in the Video mode and the sub picture is in the TV mode, you might not hear the sound of main picture when pressing the <b>SWAP</b> (↔) button after changing the sub picture channel. At this time, reselect the channel of main picture.
<b>TV/VIDEO</b>	Used to assign a source of sub picture ( <b>TV</b> , <b>AV1</b> , <b>AV2</b> , <b>AV3</b> or <b>S-Video</b> ).
<b>SIZE</b>	Used to select a size of sub picture ( <b>Double</b> , <b>Large</b> , <b>Small</b> , or <b>16 PIP</b> ).
<b>POSITION</b>	Used to move the sub picture counterclockwise.
<b>P</b> ^ / v	Used to select the channel of sub picture.

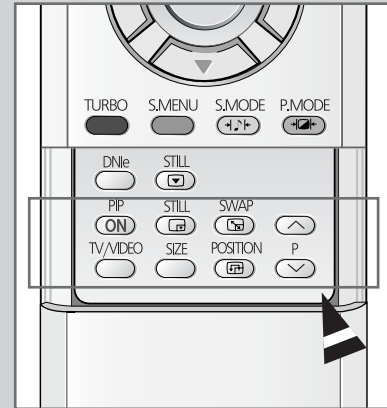

## Teletext Feature

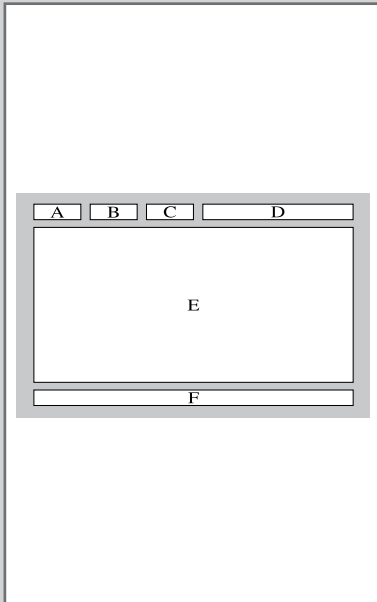

Most television channels provide written information services via teletext. Information provided includes:

- ◆ Television programme times
- ◆ News bulletins and weather forecasts
- ◆ Sports results
- ◆ Travel information

This information is divided into numbered pages (see diagram).

Part	Contents
A	Selected page number.
B	Broadcasting channel identity.
C	Current page number or search indications.
D	Date and time.
E	Text.
F	Status information. FASTEXT information.

- It can be different from depending on TTX source.
- Teletext information is often divided between several pages displayed in sequence, which can be accessed by:
  - ◆ Entering the page number
  - ◆ Selecting a title in a list
  - ◆ Selecting a coloured heading (FASTEXT system)

## Displaying the Teletext Information

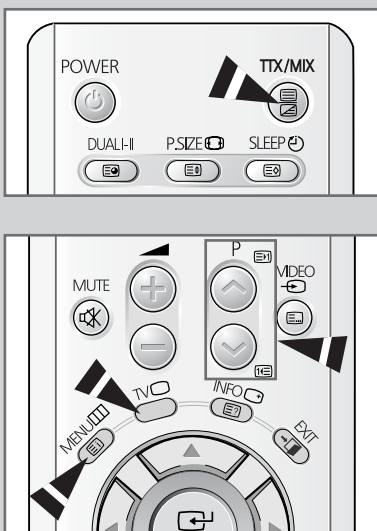

You can display Teletext information at any time on your television.

- 👉 For Teletext information to be displayed correctly, channel reception must be stable; otherwise:
  - ◆ Information may be missing
  - ◆ Some pages may not be displayed



- 1 Select the channel providing the Teletext service using the or button.
- 2 Press the **TTX/MIX** () button to activate the teletext mode.  
Result: The contents page is displayed. It can be redisplayed at any time by pressing the (index) button.
- 3 If you wish to display the actual broadcast at the same time as the teletext page, press the **TTX/MIX** () button.
- 4 Press the **TV** () button to exit from the teletext display.

## Selecting a Page by Number







You can enter the page number directly by pressing the numeric buttons on the remote control.

- 1 Enter the three-digit page number given in the content by pressing the corresponding numeric buttons.

**Result:** The current page counter is incremented and the page is then displayed.

- 2 If the selected page is linked with several secondary pages, the secondary pages are displayed in sequence. To freeze the display on a given page, press the  (hold). Press the  (hold) again to resume.

Using the various display options:

To display...	Press the...
◆ Both teletext information and the normal broadcast	<b>TTX/MIX</b> (  ) twice
◆ Hidden text (answers to quiz games, for example)	 (reveal)
◆ The normal screen	 (reveal) again
◆ A secondary page, by entering its 4-digit number	 (sub-page)
◆ The next page	 (page up)
◆ The previous page	 (page down)
◆ Double-size letters in the: <ul style="list-style-type: none"> <li>• Upper half of the screen</li> <li>• Lower half of the screen</li> </ul>	 (size) <ul style="list-style-type: none"> <li>• Once</li> <li>• Twice</li> </ul>
◆ Normal screen	<ul style="list-style-type: none"> <li>• Three times</li> </ul>

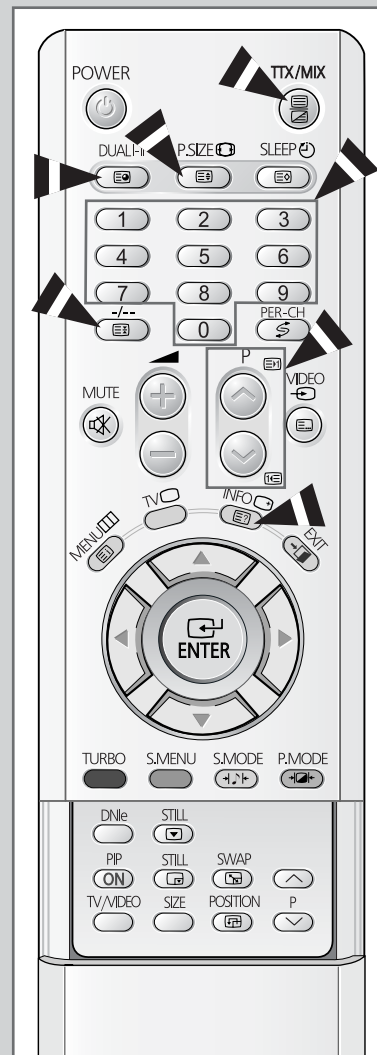

ENG

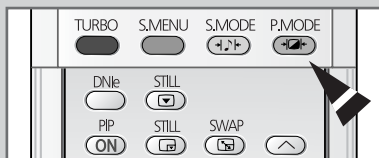

## Using FLOF to Select a Page





The various topics included in the teletext pages are color-coded, and can be selected by pressing the colored buttons on the remote control.

- 1 Display the teletext contents page by pressing the **TTX/MIX** (  ) button.
- 2 Press the coloured button corresponding to the topic that you wish to select; the available topics are given on the status line.  
**Result:** The page is displayed with other coloured information that can be selected in the same way.
- 3 To display the previous or next page, press the corresponding coloured button.
- 4 To display the subpage, see the following steps.
  - ◆ Press the  (sub-page) button.  
**Result:** The available subpages appear.
  - ◆ Select the required sub-page. Sub-pages can be scrolled by using the **TURBO** (Red) or **S.MENU** (Green) button.

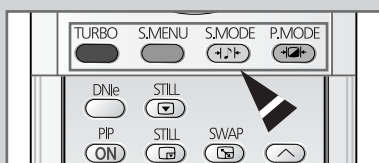
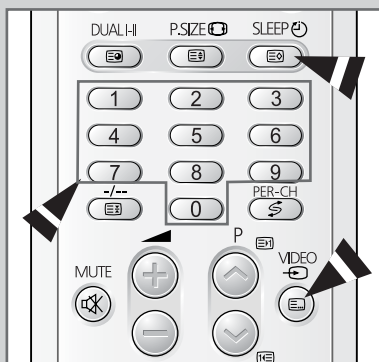
## Storing Teletext Pages



You can store up to four teletext pages to display them later at leisure.

- 1 Select the LIST mode using the  button.  
**Result:** Four 3-digit numbers are displayed in different colours.  
➤ The  button is used to switch between the LIST and FLOF modes.
- 2 Press the coloured button corresponding to the page that will be replaced.
- 3 Enter the new page number using the numeric buttons.
- 4 Repeat steps 2 and 3 for each page to be stored, using a different coloured button each time.
- 5 Press the  (store) button until the corresponding blocks blink.

## Connecting to the External Input/Outputs

ENG

### Rear of the TV (depending on the model)

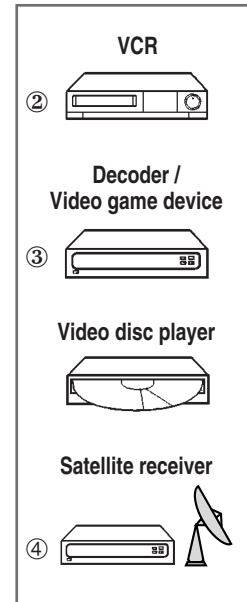
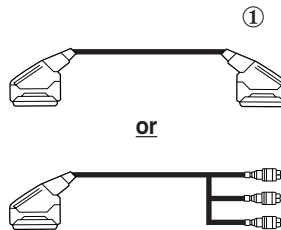
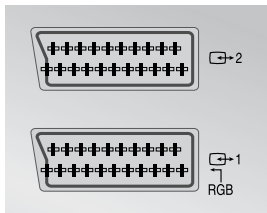
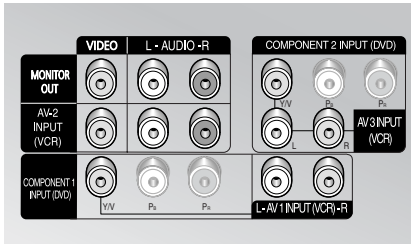

◆ “MONITOR OUT (or 2)” is used for the audio/video output of current television programme.

- ① This end can be fitted with:
  - ◆ A SCART connector
  - ◆ Three RCA connectors (Video + Audio-L and R)
- ② If you have a second VCR and wish to copy cassettes tape, connect the source VCR to “AV 2 INPUT (VCR) (or 1)” and the target VCR to “MONITOR OUT (or 2)” so that you can redirect the signal from “AV 2 INPUT (VCR) (or 1)” to “MONITOR OUT (or 2)”.
- ③ If you have a decoder, connect the decoder to the VCR and the VCR to the television.
- ④ When you wish to record a programme, connect the receiver to “AV 2 INPUT (VCR) (or 1)” and the VCR to “MONITOR OUT (or 2)” so that you can redirect the signal from “AV 2 INPUT (VCR) (or 1)” to “MONITOR OUT (or 2)”.

☞ Whenever you connect an audio or video system to your television, ensure that all elements are switched off. Refer to the documentation supplied with your equipment for detailed connection instructions and associated safety precautions.

## Connecting to the DVD Player

### Rear of the TV

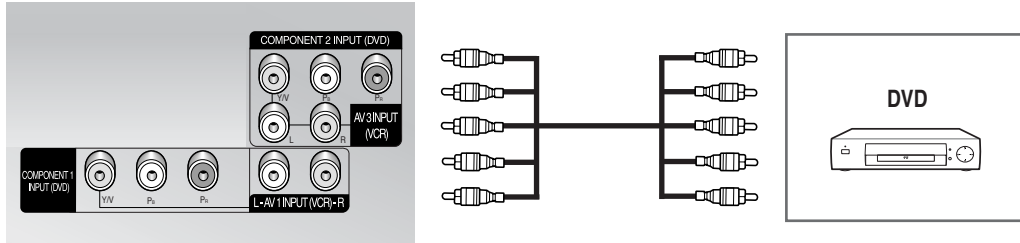

- ◆ Connect the RCA Cable to “L” and “R” on the rear of your television and the other end to “Audio Out” connector of the DVD player. Connect the RCA Cable to “Y”, “Pb”, and “Pr” on the rear of your television and the other end to the “Component Video Out (Y, Pb, Pr)” connectors of the DVD player.
- ◆ Only black signal is output from a monitor in **Componet1** or **Componet2** mode.

## Connecting to the Audio Output

- The “MONIOR OUT” (L-AUDIO-R) connectors are used for equipment, such as an audio system (to take full advantage of the Surround sound effect).

### Rear of the TV (depending on the model)

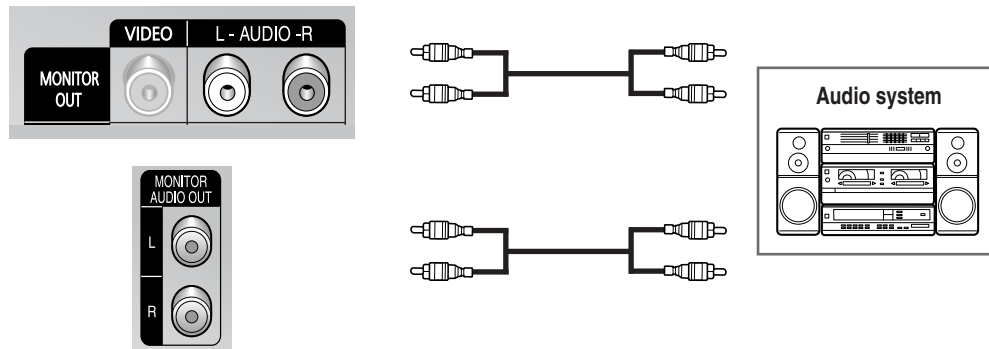

## Connecting to the RCA Input

- The RCA (VIDEO and AUDIO-L+R) connectors are used for equipment, such as camcorders, video disc players, and some video game devices.

### Side of the TV

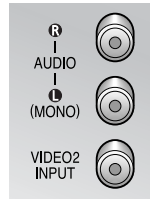

### Camcorder

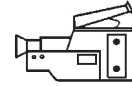

### Video game device

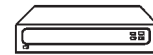

### Video disc player



## Connecting to the S-Video Input

- The S-VIDEO and RCA (AUDIO-L+R) connectors are used for equipment with an S-Video output, such as a camcorder or VCR.

### Side of the TV

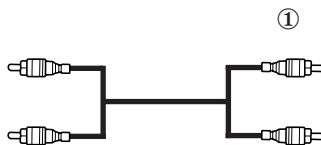
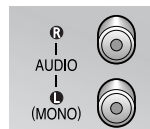

and



### Camcorder

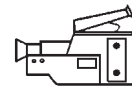

### VCR

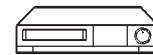

- ① To play pictures and sound, both the S-VIDEO and RCA connectors must be used.

- When both the side AV and rear connectors are connected to external equipments, the side AV receives priority.

## Connecting to the PC Input (depending on the model)

ENG

- The PC INPUT/RCA(AUDIO-L+R) connectors are used for interfacing with your PC.

### Side of the TV

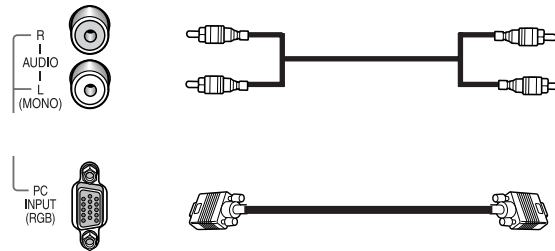

- **How to Set up Your PC Software (Windows only)**

The Windows display-settings for a typical computer are shown below. But the actual screens on your PC will probably be different, depending upon your particular version of Windows and your particular video card. But even if your actual screens look different, the same, basic set-up information will apply in almost all cases. (If not, contact your computer manufacturer or Samsung Dealer.)

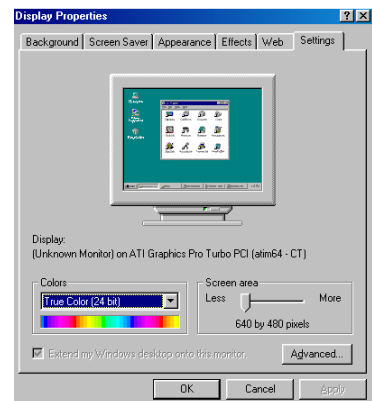

First, click on **Settings** on the Windows start menu.  
While **Settings** is highlighted, move the cursor so that **Control Panel** is highlighted.  
When the control panel screen appears, click on **Display** and a display dialog-box will appear.  
Navigate to the **Settings** tab on the display dialog-box.

The correct setting of size (resolution) is **640 x 480 pixels**.

If a vertical-frequency option exists on your display settings dialog box, the correct value is **60 or 60 Hz**. Otherwise, just click **OK** and exit the dialog box.

- Only black signal is output from a monitor in PC mode.



## Connecting Headphones

ENG

*You can connect a set of headphones to your television if you wish to watch a television programme without disturbing the other people in the room.*

- 1 Plug a set of headphones into the 3.5 mm mini-jack socket of the television.

**Result:** The sound is heard through the headphones.

- 2 When you wish to hear the sound through the speakers again, simply disconnect the headphones.

➤ Prolonged use of headphones at a high volume may damage your hearing.

*Side of the TV*

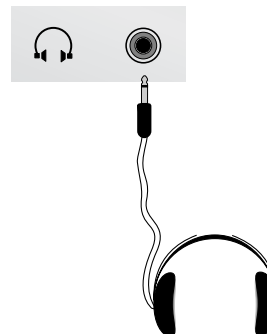

## Viewing Pictures From External Sources

*Once you have connected up your various audio and video systems, you can view different sources by selecting the appropriate input.*

- 1 Check that all the necessary connections have been made.
- 2 Switch your television on, then press the **VIDEO** (↔) button repeatedly.

**Result:** The input sources are displayed in the following order:

- ◆ **TV - AV1 - AV2 - AV3 - S-VIDEO - Component1 - Component2.** (RCA Model)
- ◆ **TV - AV1 - AV2 - S-VIDEO** (SCART Model)

➤ Depending on the source selected, the pictures may appear automatically.

➤ To watch television programmes again, press the **TV** (□) button and select the number of the channel required.

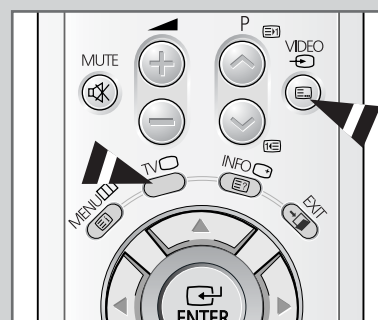

## Automatic Degaussing to Remove Colour Patches

A degaussing coil is mounted around the picture tube, so you do not normally need to degauss the television manually.

If you move the television to a different position and color patches appear on the screen, you must:

- ◆ Switch the television off by pressing the “⏻” (On/Off) button on the front panel
- ◆ Unplug the television from the wall socket
- ◆ Leave the television power-off for about 30 minutes so that the automatic degauss function can be activated, and then press the “POWER ⏻” button on the remote control.



If your television will be left unattended, press the “⏻” (On/Off) button to turn your television off.

## Troubleshooting: Before Contacting Service Personnel

*Before contacting Samsung after-sales service, perform the following simple checks.*

*If you cannot solve the problem using the instructions below, note the model and serial number of the television and contact your local dealer.*

No sound or picture	<ul style="list-style-type: none"> <li>◆ Check that the mains lead has been connected to a wall socket.</li> <li>◆ Check that you have pressed the “⏻” button (On/Off) and the <b>POWER</b> (⏻) button.</li> <li>◆ Check the picture contrast and brightness settings.</li> <li>◆ Check the volume.</li> </ul>
Normal picture but no sound	<ul style="list-style-type: none"> <li>◆ Check the volume.</li> <li>◆ Check whether the volume <b>MUTE</b> (🔇) button on the remote control has been pressed.</li> </ul>
No picture or black and white picture	<ul style="list-style-type: none"> <li>◆ Adjust the colour settings.</li> <li>◆ Check that the broadcast system selected is correct.</li> </ul>
Sound and picture interference	<ul style="list-style-type: none"> <li>◆ Try to identify the electrical appliance that is affecting the television, then move it further away.</li> <li>◆ Plug your television into a different mains socket.</li> </ul>
Blurred or snowy picture, distorted sound	<ul style="list-style-type: none"> <li>◆ Check the direction, location and connections of your aerial. This interference often occurs due to the use of an indoor aerial.</li> </ul>
Remote control malfunctions	<ul style="list-style-type: none"> <li>◆ Replace the remote control batteries.</li> <li>◆ Clean the upper edge of the remote control (transmission window).</li> <li>◆ Check the battery terminals.</li> </ul>

**Memo**

ENG

Large empty rectangular box for writing the memo content.

---

**– AFTER SALES SERVICE**

---

- Do not hesitate to contact your retailer or service agent if a change in the performance of your product indicates that a faulty condition may be present.

