



DVD HDD Recorder



DVD-H40A

THIS APPLIANCE IS DISTRIBUTED BY

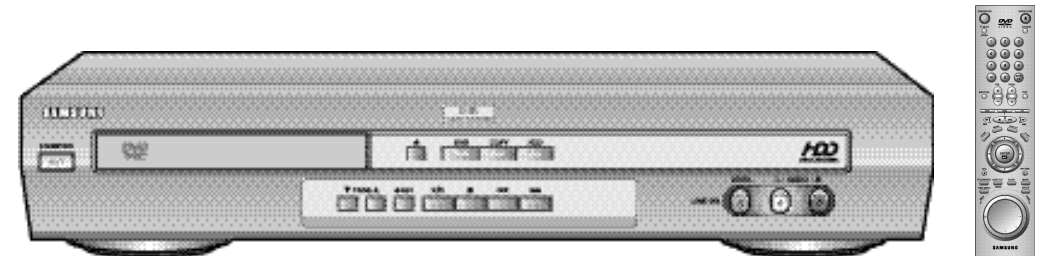
User's Manual



Safety Instructions

 **CAUTION**
RISK OF ELECTRIC SHOCK.
DO NOT OPEN 

CAUTION:
TO REDUCE THE RISK OF ELECTRIC SHOCK,
DO NOT REMOVE REAR COVER. NO USER
SERVICEABLE PARTS INSIDE. REFER
SERVICING TO QUALIFIED
SERVICE PERSONNEL.

CLASS 1 LASER PRODUCT

This Compact Disc player is classified
as a CLASS 1 LASER product.

Use of controls, adjustments or performance of
procedures other than those specified herein may result
in hazardous radiation exposure.

CAUTION-INVISIBLE LASER RADIATION WHEN OPEN AND INTERLOCKS DEFEATED, AVOID EXPOSURE TO BEAM.

 This symbol indicates that dangerous voltage
which can cause electric shock is present inside
this unit.

 This symbol alerts you to important operating
and maintenance instructions accompanying
the unit.

WARNING: To reduce the risk of fire or electric
shock, do not expose this appliance to
rain or moisture.

CAUTION: TO PREVENT ELECTRIC SHOCK,
MATCH WIDE BLADE OF PLUG TO
WIDE SLOT, FULLY INSERT.

The following illustrations represent precautions.



The lightning bolt is a warning sign alerting you to dangerous voltage inside the product.
DO NOT OPEN THE DHR. Refer to service personnel.

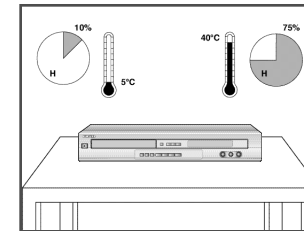

Do NOT expose the **DHR** to
extreme temperature condi-
tions (below 5°C and above
40°C) or to extreme humidity
conditions (less than 10% and
more than 75%).

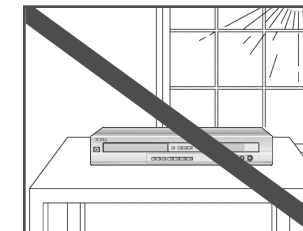

Do NOT expose the **DHR** to
direct sunlight.

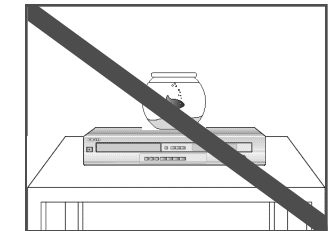

Do NOT expose the **DHR** to
any liquids.

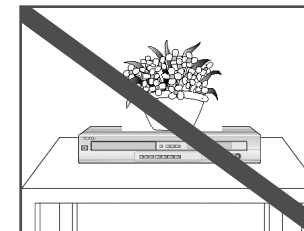

Do NOT place any objects on
the **DHR** or remote control.

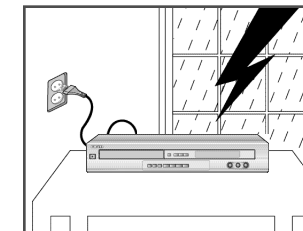

During a storm and/or light-
ning, unplug the **DHR** from the
mains jack and aerial.

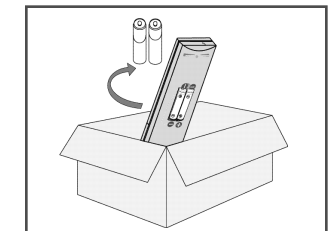

If the remote control is not
used for a long period of time,
remove the batteries and store
it in a cool, dry place.

THIS DEVICE IS NOT FOR USE IN INDUSTRIAL
ENVIRONMENTS

Key features of DVD-H40A

1. Digital Video Recording.
2. Recorded Program List.
3. Highlight Play.
4. Editing Recorded Video.
5. DVD, CD, VCD, MP3, Photo CD Play.
6. Digital Audio Juke Box.
7. Family Photo Album.
8. Connection with DVC, VCR or STB.

1. Digital Video Recording

“Instant recording” of TV program by pushing one button. Unlike VCR, it provides consumer to record TV program instantly by touching record button on the remote.

“Live TV Pause” guarantees consumer not to miss a single TV scene. This function allows consumer who is watching TV program to work on other stuffs without missing a single scene.

“High Quality Video recording” from TV DVD (VCD), DVC and STB to HDD.

It supports 3 video recording modes at the different bit rates such as SQ (2Mbps / 40h), HQ (4Mbps / 20h) and SHQ (6Mbps / 13 hours). It can be stored up to 500 Clips.

“Live TV Control” allows you to go back in time axes and experience what you missed on the live TV broadcasting. Simply press the Pause button (▶||) when you leave and when you return, DVD-H40 will instantly replay what you missed while you were away.

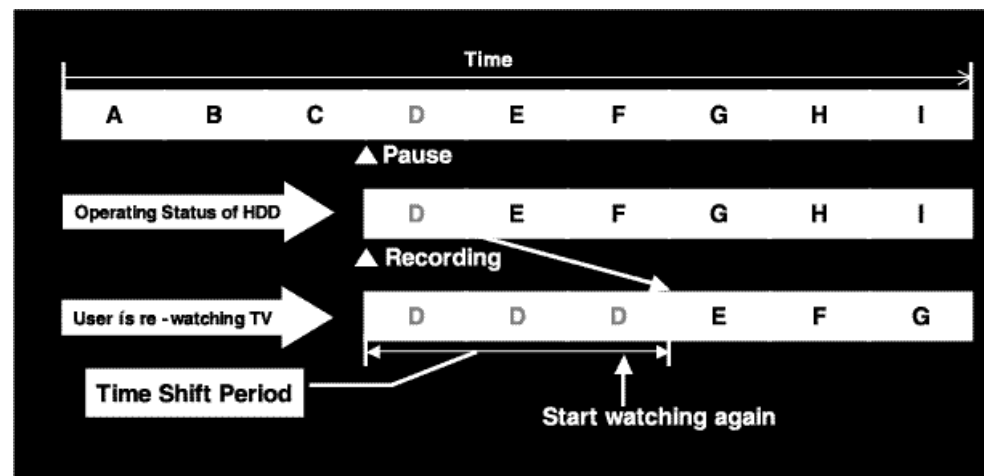

Key features of DVD-H40A (cont.)

2. Recorded Program List

- If customer record the video program, “Program List” will be generated automatically for easy understanding of the recorded program.
- This program list includes “Title Name”, “Date” and “Length”. Title name can be changed by the “Title Insert Function”.

Thumbnail picture of the first clip will be displayed.

Every necessary keys for operating the current menu screen are also arranged in this bottom area with icons and instructions.

| Program List | | | |
|--------------|--------------|----------------|--------|
| | Title | Date | Length |
| 001 | Ant | 02.05.04 11:13 | 00:30 |
| 002 | Top-gun | 02.05.06 10:17 | 01:53 |
| 003 | Pretty woman | 02.05.10 08:55 | 43 sec |
| 004 | Beach | 02.05.01 12:11 | 00:12 |

Instructions: ◀▶ Move, [Enter] Enter, [Return] Return, [Menu] Menu, [Exit] Exit, [P-List] Highlight Play

3. Highlight Play

- At the program list, if you push “P – List” button on the remote, you can preview the highlight of selected video program like as you can see in the start part of the movie for introducing the next coming movie.

| Program List | | | |
|--------------|--------------|----------------|--------|
| | Title | Date | Length |
| 001 | Ant | 02.05.04 11:13 | 00:30 |
| 002 | Top-gun | 02.05.06 10:17 | 01:53 |
| 003 | Pretty woman | 02.05.10 08:55 | 43 sec |
| 004 | Beach | 02.05.01 12:11 | 00:12 |

Instructions: ◀▶ Move, [Enter] Enter, [Return] Return, [Menu] Menu, [Exit] Exit, [P-List] Highlight Play

4. Editing the Recorded Video Program

- Samsung DVD-H40 will offer the fun to generate his own video program by himself.
- User can combine 2 or more video programs as a one video program.

Combine

Play list

Name : Ant Date : 02.05.07 05:07

Combine Execute

Instructions: ◀▶ Move, [Enter] Enter, [Return] Return, [Menu] Menu, [Exit] Exit, ◀▶ Prev/Next Page

Key features of DVD-H40A (cont.)

4. Editing the Recorded Video Program

- DVD-H40 can divide selected video program as 2 or more programs.

< start position >
 1. Pressing enter button, then division will start
 2. Color will be changed. (White -> Blue)

< end position >
 1. Pressing enter button, then division will start
 2. Color will be changed. (Blue->White)
 3. Create sub-picture

1. playing picture (1 frame)
 2. FPS, RPS, pause keys can be used

divided File Current position White bar File length

- DVD-H40 can delete unnecessary video programs.
- Even partial deletion of selected video program is possible.

Selected file enter key, then display pop-up menu for delete option

5. DVD, CD, VCD, MP3, Photo CD Play

- DVD-H40 can play many kinds of discs like as DVD, Audio CD, Video CD, MP3 (CD-R/RW), Photo CD (Kodak), CD-G, etc.

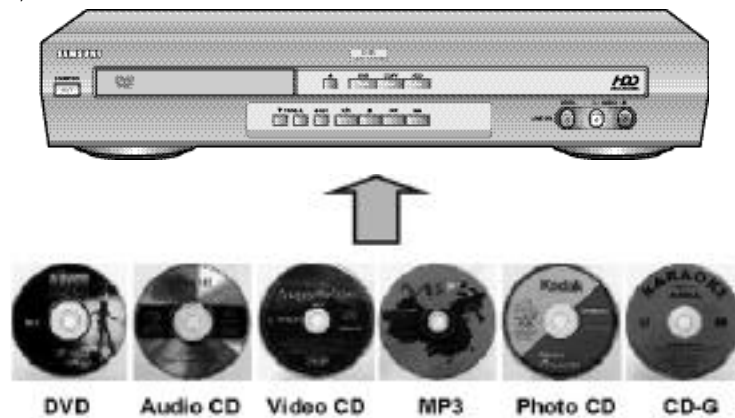

Key features of DVD-H40A (cont.)

6. Digital Audio Jukebox

- “Juke box” enables consumer to enjoy thousands of music in HDD without replacing Audio CD every time. DVD-H40 allows MP3 music from CD to be downloaded into HDD as many as consumer wants. (Max. capacity of HDD for MP3 : 10GB)

Indicates selected file

- If user include his/her favorite photos in the same music folder, then user can enjoy the music slide show also.

- At the edit mode, user can generate his/her own music folder like as “CLASSIC”, “JAZZ”, “POP SONG” and so on.

Key features of DVD-H40A (cont.)

7. Family Photo Album

- Enjoy JPEG Images from CD or HDD with easy & user friendly GUI.

Up to 10,000 JPEG images (Standard file size 100kbyte) can be saved and edited in HDD.
It supports Kodak Photo CD format.

8 Thumbnails per page
Navigate between thumbnails using remote control directional buttons

Limited to 20 string

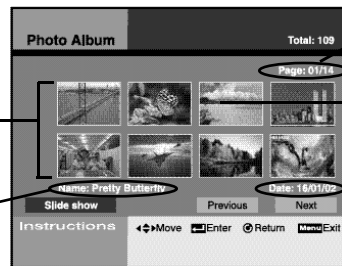

Page indicates number of pages of thumbnails

Selected photo is highlighted for enlargement.
"Enter" on remote control enlarges photo to full screen

Date show when the selected photo was taken

- "Viewing Individual Photo"

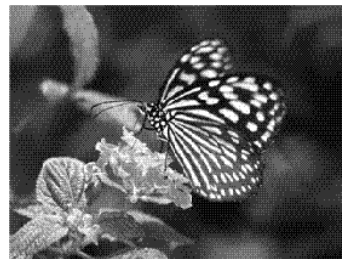

- "Slide Show"



Time setting range
3 sec ~ 10 sec

Pushed "enter" key, then pop-up menu will be display.
After delay time setting, started slide show.

Key features of DVD-H40A (cont.)

- Editing function enables you to select, clear, delete, move or rename your favorite images or photo and make your own directory.

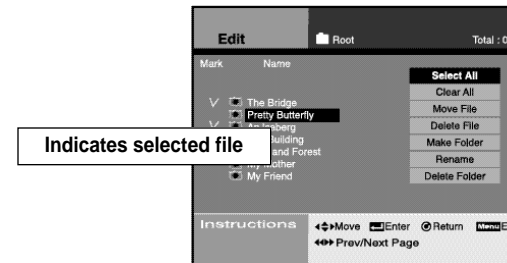

Indicates selected file

- User can easily select the photos what he wants to copy from CD to HDD at the below GUI screen.

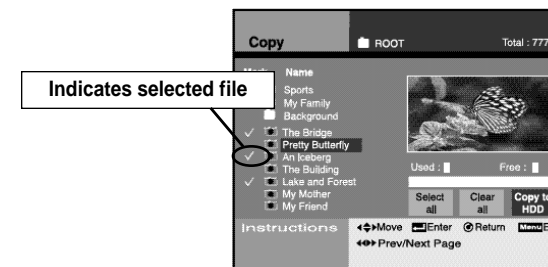

Indicates selected file

8. Connection to DVC or DSC

- Connecting DSC or DVC through A/V Input port enables to enjoy and edit those video programs simply through TV screen.

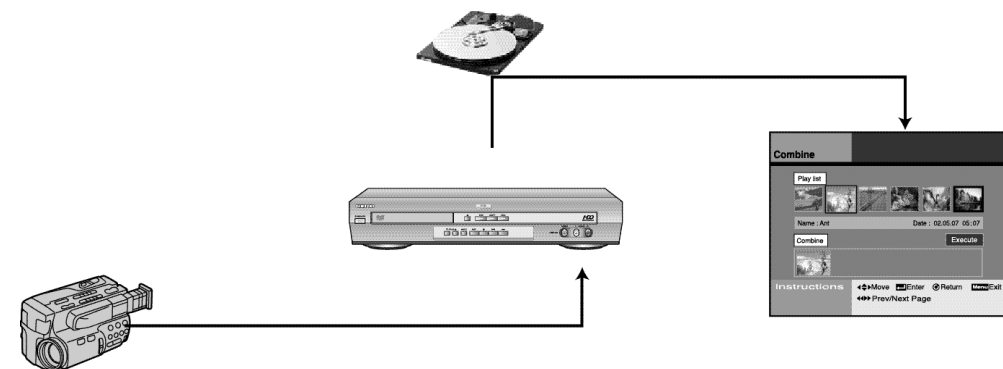

This product incorporates copyright protection technology that is protected by method claims of certain U.S. patents and other intellectual property rights owned by Macrovision Corporation and other rights owners. Use of this copyright protection technology must be authorized by Macrovision Corporation, and is intended for home and other limited viewing uses only unless otherwise authorized by Macrovision Corporation. Reverse engineering or disassembly is prohibited.

INTRODUCTION

Disc Type and Characteristics ----- 12
 MP3 Play (CD-R MP3 disc requirements) ----- 13
 Front View of the DHR(DVD HDD Recorder) ----- 14
 Rear View of the DHR(DVD HDD Recorder) ----- 14
 Display Indicators ----- 15
 Accessories ----- 15
 Infrared Remote Control ----- 16
 Inserting Batteries in the Remote Control ----- 17
 Deciding How to Connect DHR(DVD HDD Recorder) ----- 18
 Connecting DHR(DVD HDD Recorder) to the TV using the Coaxial Cable ----- 19
 Connecting DHR(DVD HDD Recorder) to the TV using the RCA Cable ----- 19
 Connecting Other Equipment to Your DHR ----- 20
 Using the TV Button on the Remote Control ----- 21
 Basic Connections/Auto Setup ----- 22
 DVD/HDD View ----- 23
 Basic DVD Playback ----- 23
 Basic TV Tuner Operations ----- 24
 Playing a Disc ----- 25

SET-UP

Change set language ----- 27
 Set the TV channel ----- 28
 Set the clock ----- 29
 Set the time-shift buffering time ----- 29
 Set the output audio options ----- 30
 Set the display options ----- 31
 HDD Format ----- 32

SETUP DHR(DVD HDD Recorder)

Digital Recorder
 Watch the recorded program in HDD ----- 34
 Set the parental lock ----- 35
 Change the lock password ----- 36
 Edit the recorded program in HDD(Combine) ----- 37
 Edit the recorded program in HDD(Divide) ----- 38
 Edit the recorded program in HDD(Delete) ----- 39
 Edit the recorded program in HDD(Partial Delete) ----- 40
 Record TV program(Timer program setting) ----- 41
 Recording Television Broadcast ----- 42
 Record TV program (One Touch Recording) ----- 43

DVD player
 Disc Copy ----- 45
 Preset of DVD language ----- 46
 Set the parental lock ----- 47
 Change the lock password ----- 48
 Using the Disc/Title Menu ----- 49
 3D Sound Function ----- 49
 Selecting the Audio Language ----- 50
 Selecting the Subtitle Language ----- 50
 Using the Display Function ----- 51
 Special Playback Features ----- 52
 A-B Repeat ----- 53
 Using the Zoom (DVD/VCD) ----- 54
 Changing the Camera Angle ----- 54
 Using the Bookmark Function (DVD/VCD) ----- 55

Juke Box
 View the MP3 file list in HDD/CD ----- 57
 Edit the MP3 file in HDD ----- 58
 Copy MP3 file from CD to HDD ----- 59





Photo Album
 View the JPEG file list in HDD/CD ----- 61
 Edit the JPEG file in HDD ----- 62
 Copy JPEG file from CD to HDD ----- 63

OTHERS

Technical Specifications ----- 64
 Problems and Solutions ----- 65

Disc Type and Characteristics

This DHR player is capable of playing the following types of discs with the corresponding logos :

| Disc Types (Logos) | Recording Types | Disc Size | Max. Playing Time(files) | Characteristics |
|---|-----------------|-----------|--|--|
| DVD  | Audio + Video | 12 Cm | Single-sided 240 min. Double-sided 480 min. | <ul style="list-style-type: none"> DVD contains excellent sound and video due to Dolby Digital and MPEG-2 system. Various screen and audio functions can be easily selected through the on-screen menu. |
| | | 8 Cm | Single-sided 80 min. Double-sided 160 min. | |
| VIDEO-CD  | Audio + Video | 12 Cm | 74 min. | <ul style="list-style-type: none"> Video with CD sound, VHS quality & MPEG-1 compression technology. |
| | | 8 Cm | 20 min. | |
| AUDIO-CD  | Audio | 12 Cm | 74 min. | <ul style="list-style-type: none"> An LP is recorded as an analog signal with more distortion. CD is recorded as a Digital Signal with better audio quality, less distortion and less deterioration of audio quality over time. |
| | | 8 Cm | 20 min. | |
| CD-R  | Audio + Video | 12 Cm | WAV: 74min MP3: about 150 JPG: up to file size | <ul style="list-style-type: none"> Permanent data storage - cannot be erased or over written. Storing music, images, photos. |
| | | 8 Cm | WAV: 20min MP3: about 60 JPG: up to file size | |
| CD-RW  | Audio + Video | 12 Cm | WAV: 74min MP3: about 150 JPG: up to file size | <ul style="list-style-type: none"> Record and rewrite up to 1000 times and can be read indefinitely |
| | | 8 Cm | WAV: 20min MP3: about 60 JPG: up to file size | |

- * Discs which cannot be played with this player:
- DVD-ROM
 - CD-ROM
 - CDI
 - HD layer of super Audio CD
 - CDGs play audio only, not graphics.
 - DVD-RAM
 - CDV

- * Ability to play back may depend on recording conditions:
- DVD-R, +R
 - DVD+RW, -RW
 - CD-RW
 - Photo CD : JPG file

MP3 Play (CD-R MP3 disc requirements)

When playing CD-R/RW discs, please follow the recommendations below:

- Your MP3 files should be ISO 9660 or JOLIET format.**
ISO 9660 format and JOLIET MP3 files are compatible with Microsoft's DOS and Windows, and with Apple's Mac. These two formats are the most widely used.
- When naming your MP3 files do not exceed 15 characters, and place ".mp3" as the file extension.**
General name format of: Title.mp3. When composing your title, make sure that you use 15 characters or less.
- Use a decompression transfer rate of at least 128 Kbps when recording MP3 files.**
Sound quality with MP3 files basically depends on the rate of compression/decompression you choose. Getting audio CD quality sound requires an analog/digital sampling rate (conversion to MP3 format) of at least 128 Kbps and up to 160 Kbps. However, choosing higher rates, like 192 Kbps or more, only rarely give better sound quality. Conversely, files with sampling rates below 128 Kbps will not be played properly.
- Do not try recording copyright protected MP3 files.**
Certain "secured" files are encrypted and code protected to prevent illegal copying. These files are of the following types: Windows Media™ (registered trade mark of Microsoft Inc) and SDMI™ (registered trade mark of The SDMI Foundation). You cannot copy such files.

Disc Markings



- Playback Region Number**
Both the DHR player and the discs are coded by region. These regional codes must match in order for the disc to play. If the codes do not match, the disk will not be played.

The Region Number for this player is described on the rear panel of the player.



- PAL** • PAL colour system in U.K, France, Germany, Australia, etc.



- NTSC** • NTSC broadcast system in USA, Canada, Japan, South Korea, etc.



- DOLBY DIGITAL** • Dolby Digital disc



- STEREO** • Stereo disc



- DIGITAL SOUND** • Digital Audio disc



- DTS** • DTS disc

Front View of the DHR(DVD HDD Recorder)

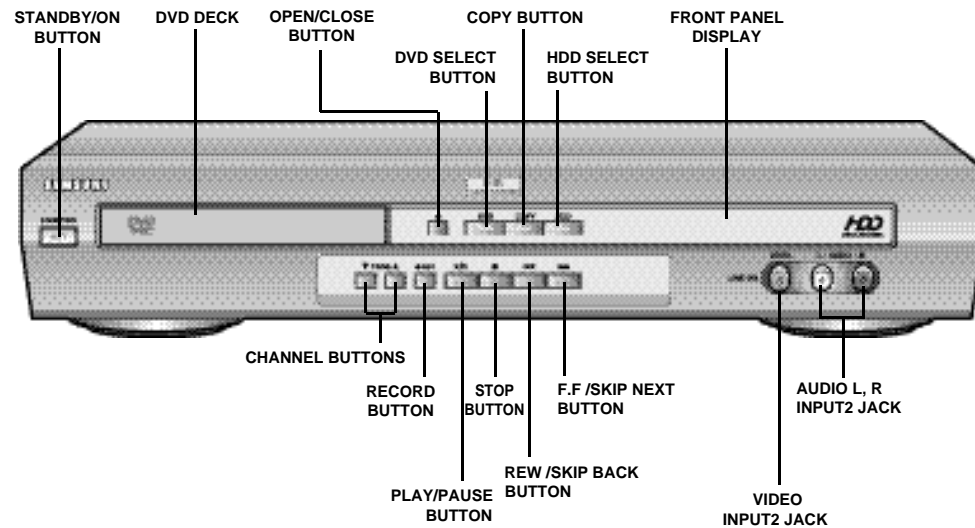

Rear View of the DHR(DVD HDD Recorder)

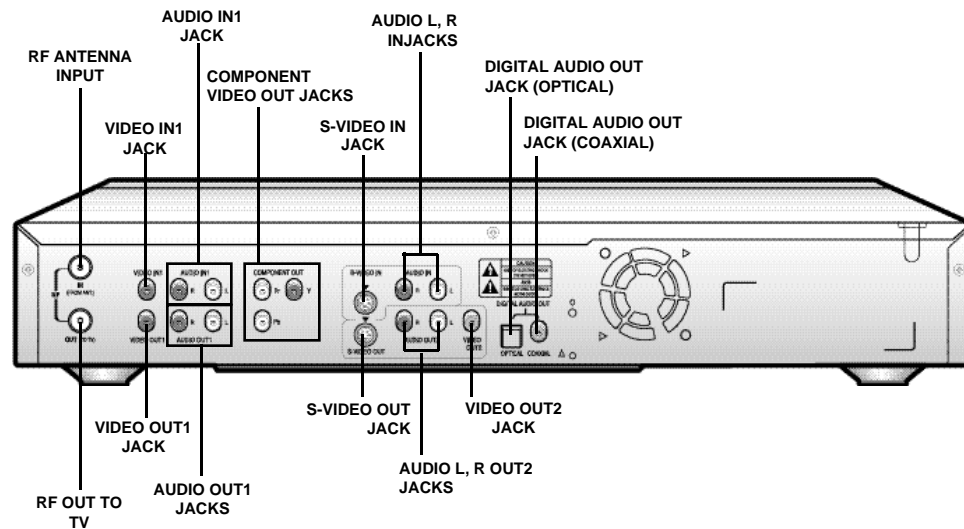

Display Indicators

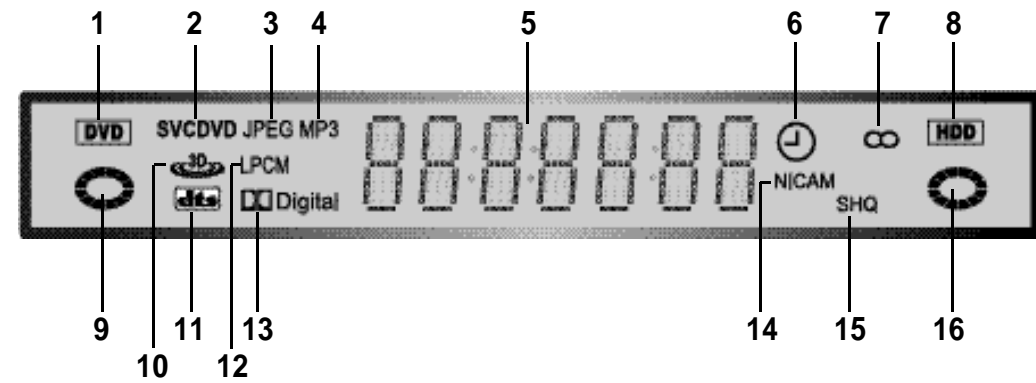

- | | |
|---|--|
| 1 DVD Deck mode indicator | 9 DVD disc is active |
| 2 Disc type indicator | 10 3D Sound is active |
| 3 JPEG file indicator | 11 A DVD with a DTS soundtrack is loaded |
| 4 MP3 file indicator | 12 LPCM type indicator |
| 5 The time, current position, time remaining or current status is displayed | 13 Dolby digital indicator |
| 6 A Timer Recording is programmed or in progress. | 14 NICAM is active |
| 7 STEREO indicator | 15 Recording Quality indicator |
| 8 HDD mode indicator | 16 HDD is active |

Accessories

You have just purchased a **SAMSUNG DHR**. Together with your DHR, you will find the following accessories in the box.

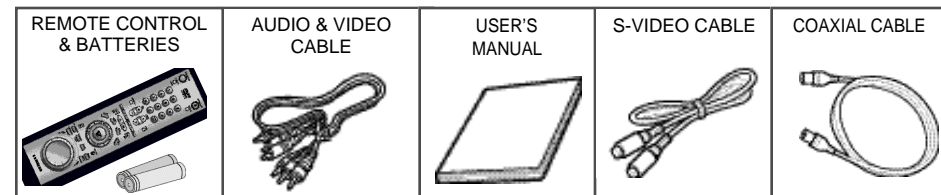

Infrared Remote Control

- 1 STANDBY/ON button
- 2 ZOOM/TV MUTE button
- 3 0-9 button
- 4 3D button
- 5 VOLUME +/- button
- 6 INPUT SELECT button
- 7 DVD button
- 8 REVERSE PICTURE SEARCH/SKIP PREVIOUS button
- 9 STOP button
- 10 MENU button
- 11 CLEAR button
- 12 ENTER/DIRECTION button
- 13 RECORD button
- 14 TITLE/SPEED button
- 15 DISC MENU button
- 16 SUBTITLE/TIMER button
- 17 OPEN/CLOSE button
- 18 TV/DHR button (not used)
- 19 REPEAT A-B button
- 20 PROGRAM button
- 21 TEXT button
- 22 TV button
- 23 HDD button
- 24 FORWARD PICTURE SEARCH/SKIP NEXT button
- 25 PLAY/PAUSE button
- 26 DISPLAY button
- 27 PLAY LIST button
- 28 RETURN button
- 29 MARK button
- 30 ANGLE button
- 31 AUDIO button
- 32 JOG/SHUTTLE

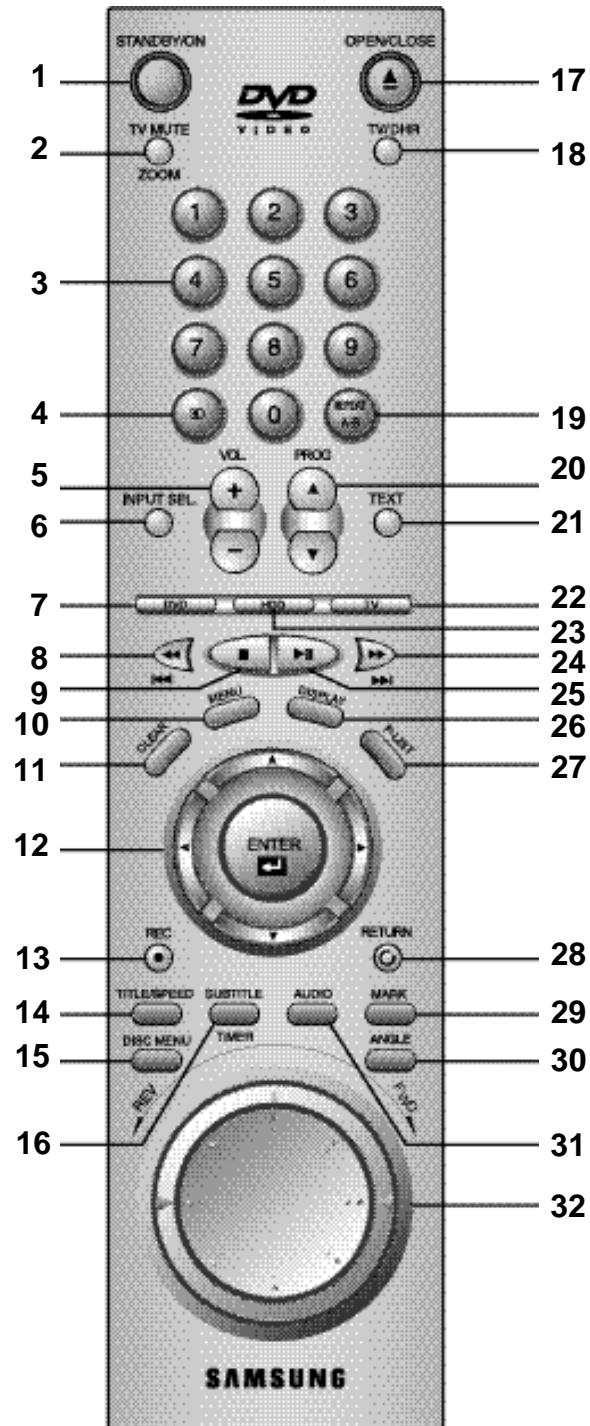

Inserting Batteries in the Remote Control

You must insert or replace the batteries in the remote control when you:

- ◆ Purchase the DHR
- ◆ Find that the remote control is no longer working correctly

- 1 Push the tab in the direction of the arrow to release the battery compartment cover on the rear of the remote control.
- 2 Insert two AA, R6 or equivalent batteries, taking care to respect the polarities:
 - ◆ + on the battery with + on the remote control
 - ◆ - on the battery with - on the remote control
- 3 Replace the cover by aligning it with the base of the remote control and pushing it back into place.

➤ Do not mix different battery types (manganese and alkaline for example).

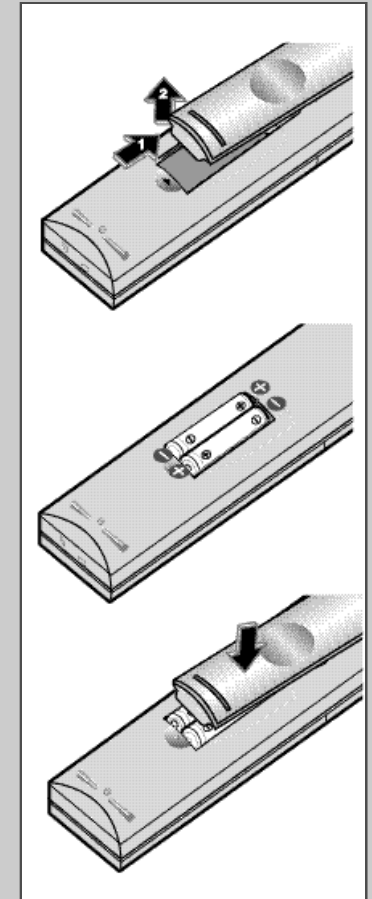















Deciding How to Connect DHR(DVD HDD Recorder)

You must take into account various factors when connecting audio or video systems:

- ◆ Types of connectors available on your systems
- ◆ Systems connected permanently to the DHR (satellite receiver for example) or temporarily (camcorder for example)

Your DHR is equipped with the following connectors.

| Connector | Location | Type | Direction | Recommended Use |
|----------------------|---|-----------------|---|--|
| LINE | Rear/Front  | Audio/Video RCA | In/Out  | <ul style="list-style-type: none"> ◆ Television ◆ Other VCR/DVD ◆ Satellite receiver |
| AUDIO input | Rear  | Audio RCA | In  | ◆ Audio In for S-VIDEO |
| COMPONENT output | Rear  | RCA | Out  | ◆ COMPONENT out |
| S-VIDEO input/output | Rear  | S-JACK | In/Out  | ◆ S-Video in/out |
| Digital AUDIO output | Rear  | Optical coaxial | Out  | ◆ Digital Audio out |
| OUT TO TV | Rear  | 75 Coaxial | Out  | ◆ Television |
| IN FROM ANT. | Rear  | 75 Coaxial | In  | <ul style="list-style-type: none"> ◆ Aerial ◆ Cable television network ◆ Satellite receiver |

 Whenever you connect an audio or video system to your DHR, ensure that all elements are switched off. Refer to the documentation supplied with your equipment for detailed connection instructions and associated safety precautions.

Connecting DHR(DVD HDD Recorder) to the TV using the Coaxial Cable

To receive television programs a signal must be received from one of the following sources:

- ◆ An outdoor aerial
- ◆ An indoor aerial
- ◆ A cable television network
- ◆ A satellite receiver

 Make sure that both the television and the DHR are switched off before connecting the cables.

- 1 Remove the aerial or network input cable from the television.
- 2 Connect this cable to the 75 coaxial socket marked IN (PROM ANT.) on the rear of your DHR.
- 3 Plug the coaxial cable supplied into the socket marked OUT (TO TV) on your DHR.
- 4 Plug the other end of the coaxial cable into the connector previously used for the aerial on the television.
- 5 To obtain better quality pictures and sound on your television, you can also connect your DHR to the television via the RCA cable (see section below) if your television is equipped with this type of connection.

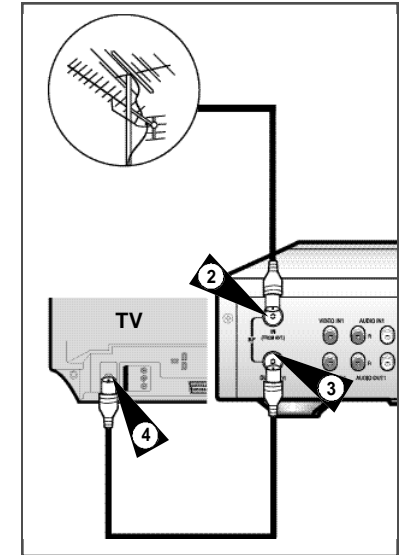

Connecting DHR(DVD HDD Recorder) to the TV using the RCA Cable

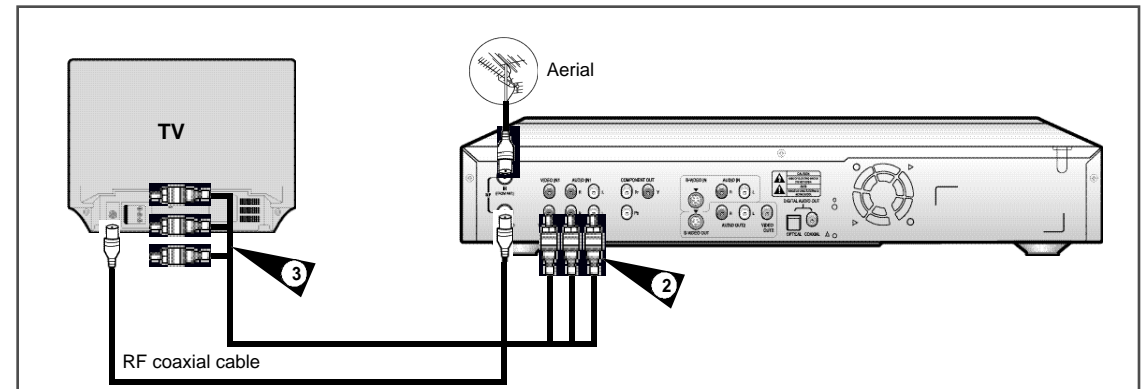

You can connect your DHR to the television using the RCA cable if the appropriate input is available on the television. You thus:

- ◆ Obtain better quality sound and pictures
- ◆ Simplify the setting up procedure of your DHR

 Regardless of the type of connection chosen, you must always connect the coaxial cable supplied. Otherwise, no picture will be visible on the screen when the DHR is switched off.

◆ Make sure that both the television and the DHR are switched off before connecting the cables.

- 1 Connect the coaxial cable as indicated in the above section.
- 2 Connect one end of the RCA Audio/Video cable to the Video output and Audio L, R output socket on the rear of the DHR.
- 3 Plug the other end into the appropriate connector on the television.

Connecting Other Equipment to Your DHR

You can connect other audio and/or video equipment to your DHR in different ways. The following illustrations give a few examples of the connection possibilities.

- The RCA input/output connectors on the rear of the DHR are used for equipment, such as camcorders, VCRs or sound systems.

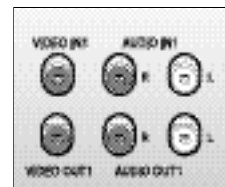

REAR OF THE DHR

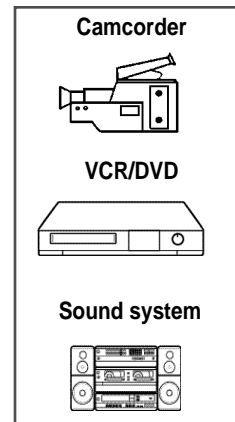
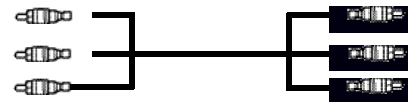

Using the TV Button on the Remote Control

Your DHR remote control will work with Samsung televisions and compatible brands.

To determine whether your television is compatible, follow the instructions below.

- 1 Switch your television on.
- 2 Point the remote control towards the television.
- 3 Hold down the TV button and enter the two-figure code corresponding to the brand of your television, by pressing the appropriate numeric buttons.

| Brand | Codes | Brand | Codes |
|-----------|--------------|---------|------------------|
| SAMSUNG | 01 to 06 | PHILIPS | 02, 20, 22 |
| AKAI | 09, 23 | SABA | 13, 14, 22 to 24 |
| GRUNDIG | 09, 17, 21 | SONY | 15, 16 |
| LOEWE | 02 | THOMSON | 13, 14, 24 |
| PANASONIC | 08, 23 to 27 | TOSHIBA | 07, 16 to 19, 21 |

- If your television is compatible with the remote control, it will be switched off. It is now programmed to operate with the remote control.

- *If several codes are indicated for your television brand, try each one in turn until you find one that works.*
- ◆ *When you change the batteries in the remote control, you must reprogram the code, following the same procedure.*

You can control the television using the following buttons.

| Button | Function |
|------------------|--|
| STANDBY/ON | Used to switch the television on and off. |
| INPUT SEL. | Used to select an external source. |
| VOL. + or - | Used to adjust the volume of the television. |
| PROG. Up or Down | Used to select the required channel. |
| TV MUTE | Used to toggle the sound on and off. |

- *The various functions will not necessarily work on all televisions. If you encounter problems, operate the television directly.*

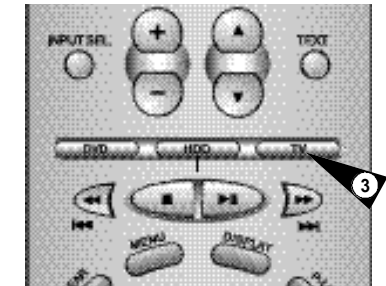

Basic Connections/Auto Setup

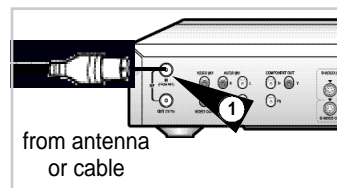

from antenna
or cable

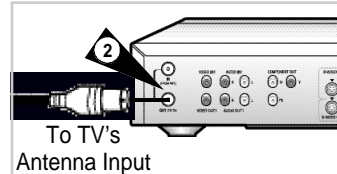

To TV's
Antenna Input

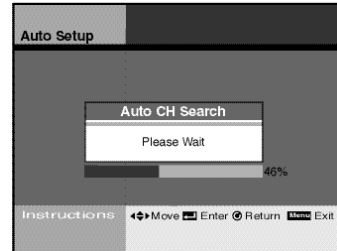
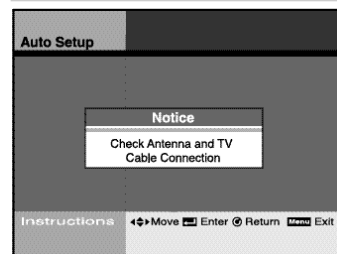
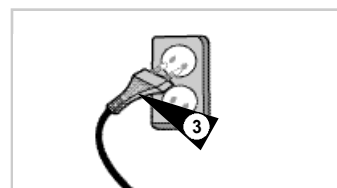

In this section, you will connect the DHR to your television and run Auto Setup, which automatically searches for channels and sets the player's internal clock.

- 1 Connect the RF antenna cable from your indoor/outdoor antenna or cable wall outlet to the IN(FROM ANT.) jack on the rear panel of the DHR.

- 2 Choose one of the following methods to connect the DHR to your TV:

RF Connection:

Connect the supplied RF antenna cable from the OUT(TO TV) jack on the rear panel of the DHR to your television's Antenna Input.

Line Connection:

Connect an RCA-type audio/video cable (red, white, yellow) from the LINE OUT jacks on the rear panel of the DHR to your television's Line In jacks. Use red for right audio, white for left audio, and yellow for video.

➤ It is recommended that you use the Line Connection if your TV is equipped with RCA jacks.

- 3 Connect the DHR power cord to a standard 220~240V/50Hz wall outlet. Then power is automatically turned on.
 - Don't press any buttons on the DHR or remote during auto setup. "AUTO" blinks while the DHR runs an auto setup procedure, where it will automatically search for all active channels.

- 4 Press the STANDBY/ON button on your TV.

- 5 Set TV to Channel 21~69 or AV. Be sure to use the same channel you selected.

➤ ◆ Even if you plan to use the S-Video Output, you MUST connect the DHR to your television with either the standard RF or the AV Out connection. This enables you to operate the DHR setup menu.

DVD/HDD View

The DHR uses one set of controls to operate DVD & HDD. The following buttons are helpful in successfully controlling each one.

- 1 Press the STANDBY/ON button on the remote control or the front panel to turn on the DHR.
- 2 Press the DVD button on the remote control or on the front panel when you want to control the DVD deck.
 - The DVD indicator will light on the Front Panel Display to show that the DVD deck is selected.
- 3 Press again the HDD button on the remote control or on the front panel when you want to control the HDD.
 - The HDD indicator will light on the Front Panel Display to show that the HDD is selected.

DVD INITIAL SCREEN



HDD INITIAL SCREEN

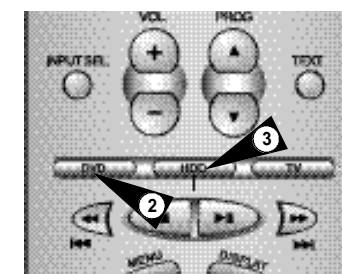

Basic DVD Playback

Follow these instructions to playback a DVD.

- 1 Open disc drawer.
 - Press the Open/Close button on the remote control or front panel.
- 2 Insert disc.
 - Place the disc in the drawer with the label side of the disc facing up. If the disc has two sides, orient the disc with the desired label facing up.
- 3 Close disc drawer.
 - Press the Open/Close button on the remote control or front panel to close the disc drawer.
- 4 Press the ►II(Play/Pause) button on the remote control or front panel.
 - Many discs will begin playback automatically when the disc drawer closes.
 - If the DVD has a disc menu, or more than one title, the disc menu may appear.
- 5 Additional DVD options.

- See pages 44~55.

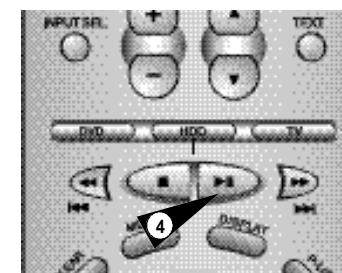
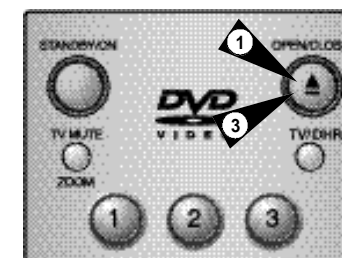

Basic TV Tuner Operations

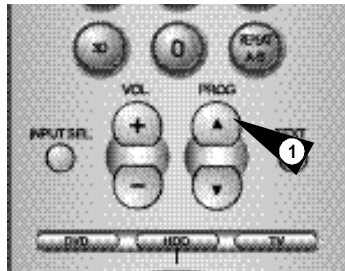

- 1 Press the **PROG. ▲▼** buttons.
 - Press to change to the next or previous channel.

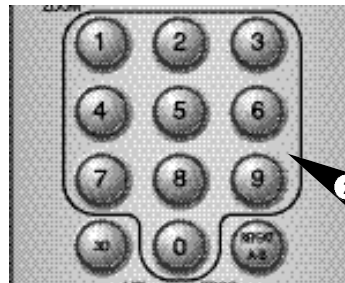

- 2 Press the **0-9** buttons.
 - Press to select channels directly.

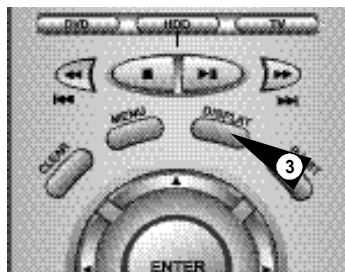

- 3 Press the **DISPLAY** button.
 - Display the channel's information you are watching.

➤ ◆ When you press the **TV/DHR** button, you will be taken directly to the screen of the AV device connected to the **LINE2**.

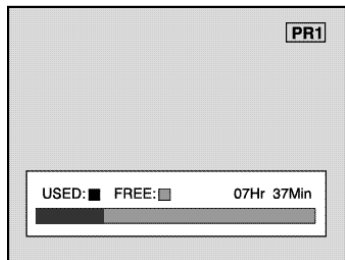

Playing a Disc

- 1 Press the **OPEN/CLOSE** button.
 - The **STANDBY** indicator light is on and the tray opens.
- 2 Place a disc gently into the tray with the disc's label facing up.
- 3 Press the **PLAY/PAUSE** button to start play.
 - When a conventional Audio CD (CDDA) is inserted, it is automatically played back as the File List is displayed on the screen. For MP3 or Photo CDs, a desired file must be selected for playback once the File List is displayed on the screen.



- 4 Press the **STOP** button to stop play.

➤ ◆ When you stop disc play, the player remembers where you stopped, so when you press **PLAY** again, it will pick up where you left off (unless the disc is removed, the **STOP** button is pressed twice or the player is unplugged.). This function works only when playing **DVD video**.

◆ To listen to the next song, press and briefly hold down the **Forward (▶▶)** button.

◆ If there are more than 8 files on the disc, press the **◀◀ Previous** or **▶▶ Next** button to view additional pages in units of 8 contiguous files.

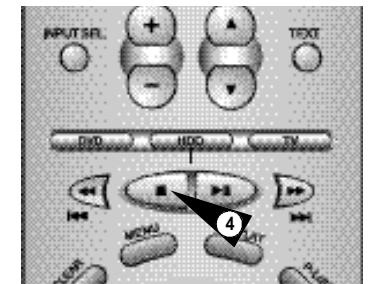
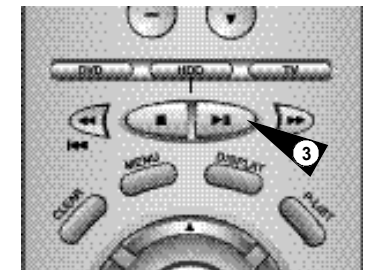

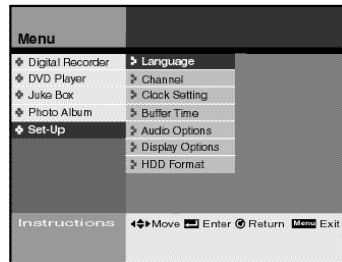

You can setup about special functions of **DHR**.

Change set language

You can select set language.
see page 27

Set the TV channel

You can set air/cable TV channel in manual or automatically.
see page 28

Set the clock

You can adjust clock on front panel display.
see page 29

Set the time-shift buffering time

You can select buffer time for time shift feature
see page 29

Set the output audio option

You can select audio option depends on audio system you have.
see page 30

Set the display option

You can select display option fit to your taste.
see page 31

HDD Format

You can erase all data or change system format in HDD.
see page 32

- !** Turn the power off and on again when the DHR works abnormal by sudden power off, plug off or not supported files, broken files in HDD.
- Abnormal working case : no key input except Standby/On button, flickering display panel.
 - Supported files in DHR : MP3, JPG.

You can select set language.

- 1 Press the MENU button.
- 2 Select Set-Up using ▲▼ buttons, then press the ENTER or ► buttons.
- 3 Select Language using ▲▼ buttons, then press the ENTER or ► buttons.
- 4 Select language you want to change using ▲▼ buttons, then press the ENTER or ► buttons.
 - Set language would be changed to selected language.

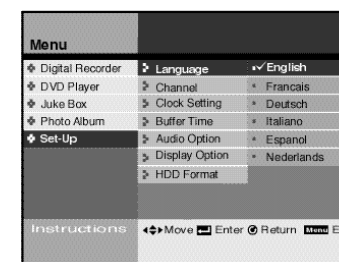
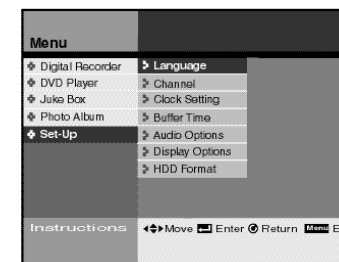
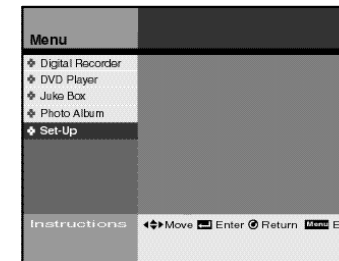

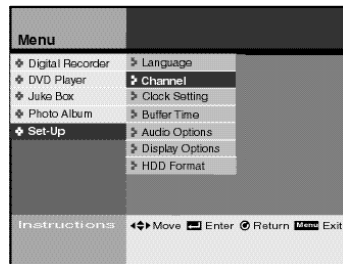
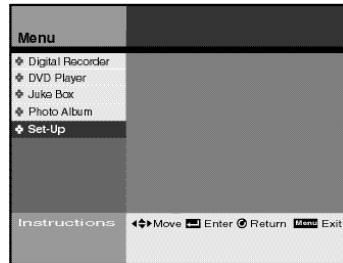

You can set air/cable TV channel in manual or automatically.
Also you can add or remove channels.

- 1 Press the MENU button.
- 2 Select Set-Up using ▲▼ buttons, then press the ENTER or ► buttons.
- 3 Select Channel using ▲▼ buttons, then press the ENTER or ► buttons.
- 4 See below submenu setup.
Select mode using ▲▼ buttons, then press the ENTER or ► buttons.

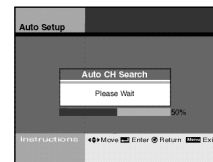

Auto Set-up

- The DHR will automatically search for all available channels in the selected Tuner Band. This procedure may take a few minutes to complete.
- When finished, the lowest channel found will be displayed.

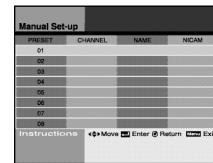

Manual Set-up

- Search & setup individual channel option in manual
- Set channels using ▲▼◀▶ or 0-9 buttons, then press the ENTER button to save.

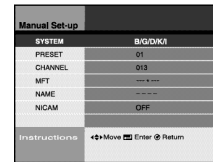

Output CH

- Select output channel to TV tuner. (21 ~ 69CH)
- Set out channel to TV using ▲▼ buttons, then press the ENTER button.
- Make sure connect RF coaxial cable between DHR and TV.

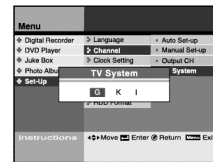
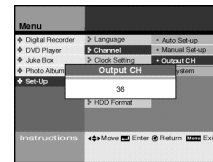

TV System

- Select system to TV out
- Set TV system using ◀▶ buttons, then press the ENTER button.

You can adjust present time and see it thru front panel display.
To use timer recording, you have to set the clock.

- 1 Press the MENU button.
- 2 Select Set-Up using ▲▼ buttons, then press the ENTER or ► buttons.
- 3 Select Clock Setting using ▲▼ buttons, then press the ENTER or ► buttons.
- 4 Adjust present time using ▲▼◀▶ buttons, then press the ENTER button.

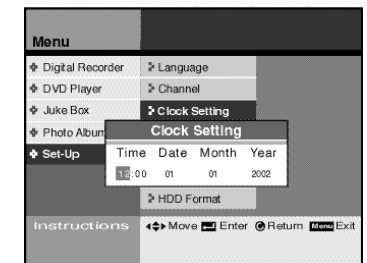

You never miss live TV programs. DHR memorizes live TV programs for 30 min up to 2 hours.

- 1 Press the MENU button.
- 2 Select Set-Up using ▲▼ buttons, then press the ENTER or ► buttons.
- 3 Select Buffer Time using ▲▼ buttons, then press the ENTER or ► buttons.
- 4 Select hours using ▲▼ buttons, then press the ENTER or ► buttons.
 - Over the selected buffer time, erased from starting scene of buffer.
 - The shorter buffer time will be helpful to save HDD's recording space
 - The default buffer time is 1 hour.

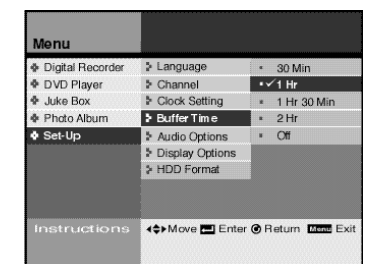
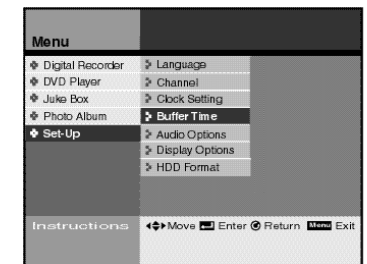

➤ Press the Return button to move to the start buffered position.

⚠ It can be taken a few seconds when the buffer time is changed.

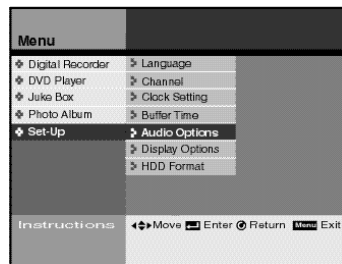
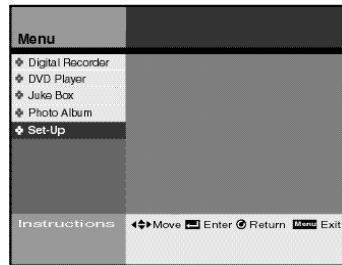

You can optimize audio status depends on your audio system.

- 1 Press the MENU button.
- 2 Select Set-Up using ▲▼ buttons, then press the ENTER or ► buttons.
- 3 Select Audio Options using ▲▼ buttons, then press the ENTER or ► buttons.
- 4 See below audio output setup. Select mode using ▲▼ buttons, then press the ENTER or ► buttons.

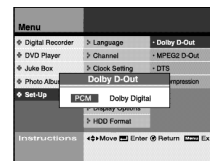

Dolby D-out

- PCM : Converts to PCM(2CH) audio. Select PCM when using the analog audio outputs.
- Dolby Digital : Converts to Dolby Digital Bitstream(5.1CH). Select Bitstream when using the digital audio output.
- Be sure to select the correct digital output or no audio will be heard.

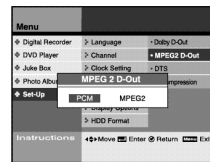

MPEG 2 D-out

- This feature supports only disc encoding to MPEG Audio.
- PCM : Converts to PCM(2CH) audio. Select PCM when using the analog audio outputs.
- MPEG 2 : Converts to Dolby Digital Bitstream(5.1CH). Select Bitstream when using the digital audio output.

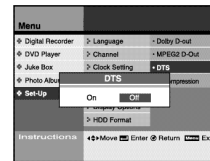

DTS

- Off : Does not output digital signal.
- On : Outputs DTS bitstream via digital output only.
- Select DTS when connecting to a DTS Decoder.

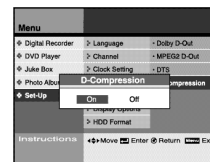

D-Compression

- This feature compresses the dynamic range (quietest sound to loudest sound) of a disc's soundtrack. For example, action scenes might be loud, while whispered dialog is quiet. The Dynamic Compression feature evens out the range of the volume by making loud sounds quieter and soft sounds louder.
- Off : To select normal dynamic range.
- On : To select compressed dynamic range.

You can adjust TV display status.

- 1 Press the MENU button.
- 2 Select Set-Up using ▲▼ buttons, then press the ENTER or ► buttons.
- 3 Select Display Options using ▲▼ buttons, then press the ENTER or ► buttons.
- 4 Select option to change using ▲▼ or ► buttons, then press the ENTER.

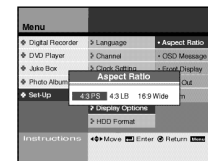
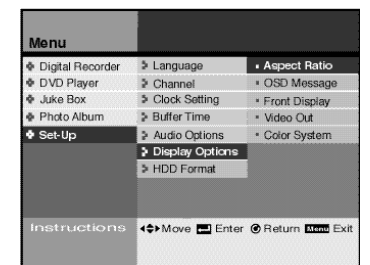
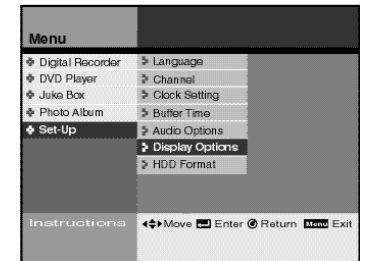
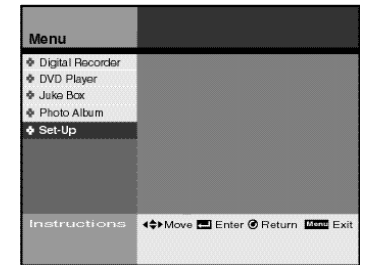

Aspect ratio

- 4:3 PS (Pan-Scan) : Select this for conventional size TVs when you want to see the central portion of the 16:9 screen.(Extreme left and right side of movie picture will be cut off.)
- 4:3 LB (Letter Box) : Select when you want to see total 16:9 ratio screen DVD supplies, even though you have a TV with 4:3 ratio screen. Black bars will appear at the top and bottom of the screen.
- 16:9 Wide :You can view the full 16:9 picture on your widescreen TV.



OSD Message

- On : Displays playing status icon or message on screen.
- Off : Not displays playing status icon or message on screen.

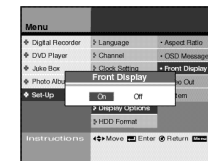

Front Display

- On : Turn on display panel all the time.
- Off : Turn off display panel all the time.

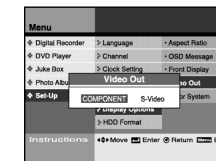

Video Out

- COMPONENT
- S-Video

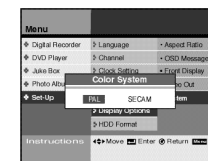

Color System

- PAL : Make sure select PAL when you watch PAL program.
- SECAM : Make sure select SECAM when you watch SECAM program.

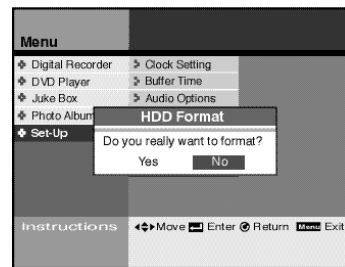
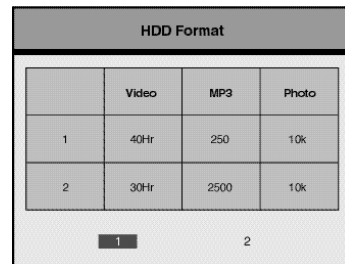
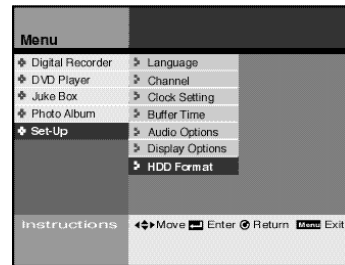

You can erase all data in HDD.

- 1 Press the MENU button.
- 2 Select Set-Up using ▲▼ buttons, then press the ENTER or ► buttons.
- 3 Select HDD Format using ▲▼ buttons, then press the ENTER or ► buttons.
- 4 Select Format option using ◀▶ buttons, then press the ENTER button.
 - Option 1 : 40Hours recording (SQ Standard)
250 MP3 Songs Store (128Kbps, 4min Standard)
10,000 JPG Images Store
 - Option 2 : 30Hours recording (SQ Standard)
2500 MP3 Songs Store (128Kbps, 4min Standard)
10,000 JPG Images Store
- 5 Select Yes, then press the ENTER button.
 - Some options you already setup can be initialized.
- 6 The power will be turned off automatically after formatting the HDD.

It has a 40Giga Byte large quantity HDD(Hard Disk Drive).
So you can edit saved programs and record in digital format(MPEG2).

Watch the recorded program in HDD

It shows you recorded program list.
see page 34

Set the parental lock

You can lock adult or violent programs for children.
see page 35~36

Edit the recorded program in HDD

You can combine, divide, delete or partial delete saved programs.
see page 37~40

Record TV program

You can record TV programs by timer recording function.
see page 41~43

- ! Turn the power off and on again when the DHR works abnormal by sudden power off, plug off or not supported files, broken files in HDD.
 - Abnormal working case : no key input except Standby/On button, flickering display panel.
 - Supported files in DHR : MP3, JPG.

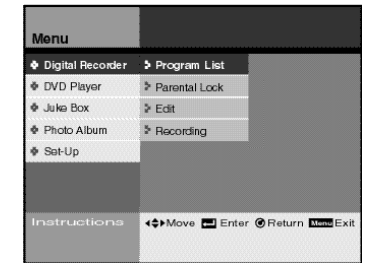

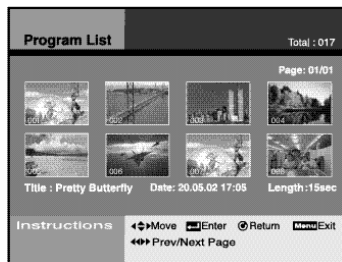
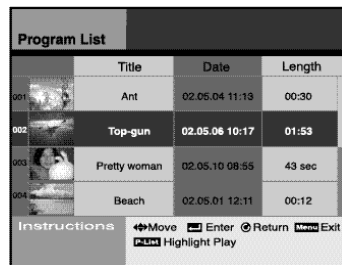
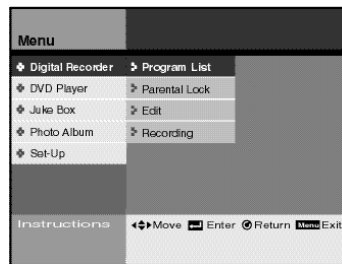
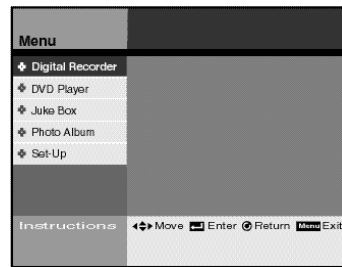

It shows recorded data and you can make it play.

- 1 Press the MENU button.
- 2 Select Digital Recorder, then press the ENTER or ► buttons.
- 3 Select Program List, then press the ENTER or ► buttons.
- 4 Select program to see using ▲▼ buttons, then press the ENTER button.
 - The Selected program starts to play, then go back to the Program list after end of playback.
 - Press the Stop button during playback, then go back to the Program list.
 - **Highlight play**
Select program, then press the P-LIST button. The selected program will be played for 5 seconds in every 5 minutes length.
- 5 Press Text button to change title.

- Press the RETURN button to go back to the previous menu.
- Press the MENU button to close menu mode.
- Press the P-LIST button to see program list in direct digest mode. (See the key-Feature part page 5)

- **Virtual keyboard**
 - Select character using ▲▼◀▶ buttons, then press the ENTER button.
 - Move cursor to the bottom right corner, then select OK and press the ENTER or RETURN button to save.

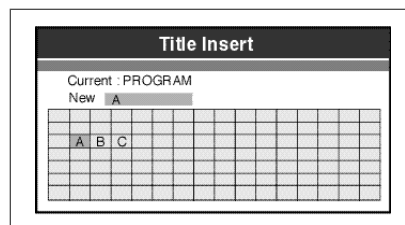

- This is the picture that appears in the program list when the TEXT key is pressed.

It prevents children from watching adult or violent programs.

- 1 Press the MENU button.
- 2 Select Digital Recorder, then press the ENTER or ► buttons.
- 3 Select Parental Lock using ▲▼ buttons, then press the ENTER or ► buttons.
- 4 Enter a 4-digit password using the 0-9 buttons on the remote control.
 - Write your password down, and keep it in safe place in case you need it to change your setting later.
 - Initial password is set as 1111.
- 5 Select Lock Setting, then press the ENTER button.
- 6 Select programs to lock using ▲▼ buttons, then press ◀ or ▶ button.
 - Lock icon is displayed.
 - The locked program is not displayed in Program list.
 - You must release the locked program first to watch it again.
- 7 Press Return or Menu button to save lock setting.

- Press the RETURN button to go back to the previous menu.
- Press the MENU button to close menu mode.
- This password is for HDD only and is different from the DVD password setting.
- See the page 65 when you forget the password.

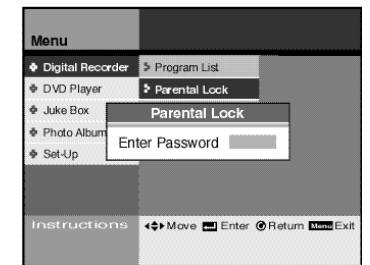
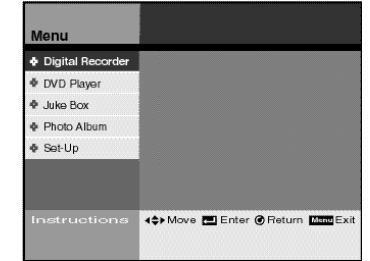

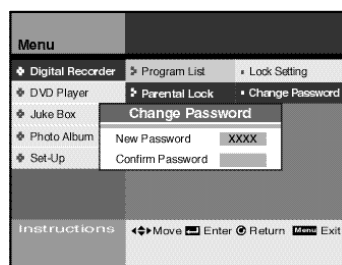
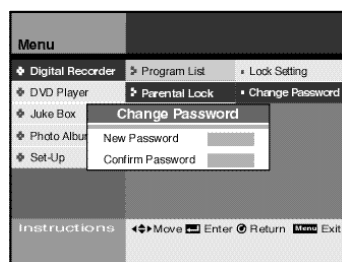
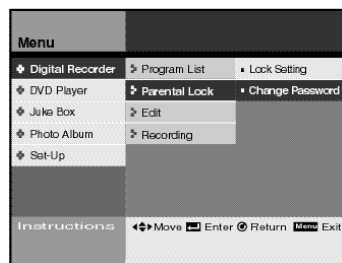

You can change password in Parental Lock menu.

- 1 Press the MENU button.
- 2 Select Digital Recorder, then press the ENTER or ► buttons.
- 3 Select Parental Lock using ▲▼ buttons, then press the ENTER or ► buttons.
- 4 Enter a 4-digit password using the 0-9 buttons on remote control.
 - Write your password down, and keep it in a safe place in case you need it to change your setting later.
 - Initial password is set as 1111.
- 5 Select Change Password using ▲▼ buttons, then press the ENTER or ► buttons.
- 6 Enter new 4-digit password using the 0-9 buttons on the remote control.
- 7 Enter the new password again to confirm.

➤ If you press RETURN button, then change password procedure is cancelled.

You can combine several programs to one, so play programs continuously.

- 1 Press the MENU button.
- 2 Select Digital Recorder, then press the ENTER or ► buttons.
- 3 Select Edit using ▲▼ buttons, then press the ENTER or ► buttons.
- 4 Select Combine, then press the ENTER or ► buttons.
- 5 Select a program to combine using ◀▶ buttons, then press the ENTER button.
 - Selected programs are displayed at below window.
 - Up to 6 programs can be selected.
 - The same program can not be selected.
- 6 Select Execute using ▼ button.
- 7 Press the ENTER button.
 - If you would like to combine selected programs, select Yes and press the ENTER button.
 - Selected programs combine to one program.
 - The combined program's initial name is "New".

➤ If you would like to cancel the Combine, select No using ◀▶ buttons and press the ENTER button.

◆ If you would like to erase the selected scene, press clear button, then the last selected scene will be erased

◆ Only final combined file is saved & displayed in program list. The original files will be erased.

Original file A B C

After combine A B C



- ◆ Live TV control will be stopped at the Edit mode.
- ◆ The combine operation cannot be performed between files whose recording qualities (SQ, HQ, or SHQ) are not the same.
- ◆ The program can be broken or erased in case of sudden power off or plug off during Edit mode (Combine, divide, delete, partial delete) using.

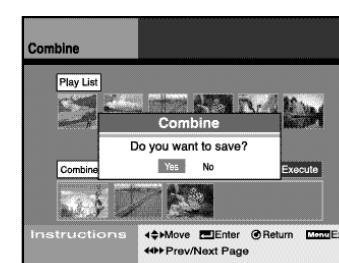
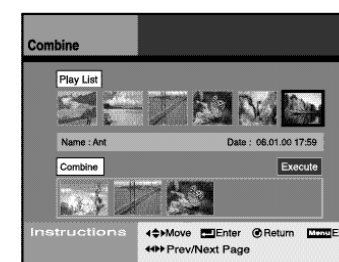
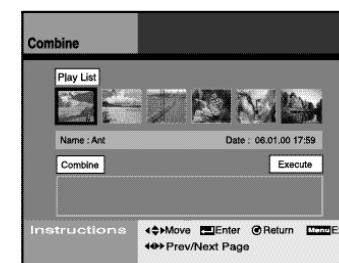
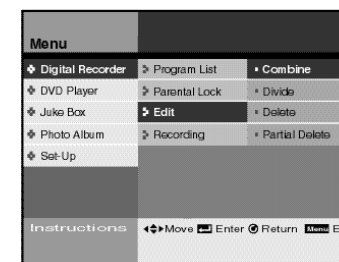

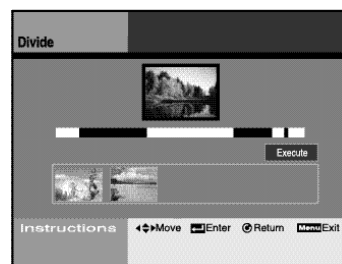
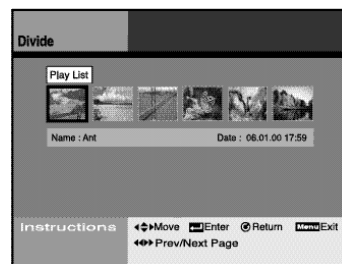
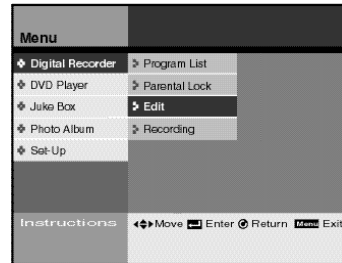

White : Unselected part
 Blue : Selected part
 Red : Current playback position

You can divide a program to several parts and save.

- 1 Press the MENU button.
- 2 Select Digital Recorder, then press the ENTER or ► buttons.
- 3 Select Edit using ▲▼ buttons, then press the ENTER or ► buttons.
- 4 Select Divide using ▲▼ buttons, then press the ENTER or ► buttons.
- 5 Select a program to divide using ◀▶ buttons, then press the ENTER button.
 - Selected program is played and playback progress bar is displayed at below.
- 6 Search parts you want to divide using ◀◀(REW), ▶▶(FF), ▶II (Play/Pause) buttons.
- 7 Press the ENTER button at start & end position to divide.
 - Press ▶II (Play/Pause) button to search in normal speed.
 - Press ◀◀ (REW), ▶▶(FF) buttons to search in fast.
 - Press ▶II (Play/Pause) button at start or end position, then press the ENTER button in pause mode.
 - The selected part would be changed from white to blue color, and the first scene of part is displayed at bottom.
- 8 You can divide a program to several parts by repeat step 7.
 - Up to 6 parts can be selected.
 - The divided program's initial name is "New".

- ◆ After divided, A'. B. C file will be saved and displayed in Program list.
- ◆ A' means a program combined with the remainder except selected parts in original file.
- ◆ The file name of A' is assigned to the original file name(the name of program A), B and C are placed its name as "New", respectively.

Original file

Divide to parts

After divided, New A', B, C files will be existed

- ⚠ ◆ Live TV control will be stopped at the Edit mode.
- ◆ The program can be broken or erased in case of sudden power off or plug off during Edit mode (Combine, divide, delete, partial delete) using.
- ◆ Make sure select the END point before move down to the Execute.

You can delete recorded programs.

This is used to delete unwanted files to free up more space.

- 1 Press the MENU button.
- 2 Select Digital Recorder, then press the ENTER or ► buttons.
- 3 Select Edit using ▲▼ buttons, then press the ENTER or ► buttons.
- 4 Select Delete using ▲▼ buttons, then press the ENTER or ► buttons.
- 5 Select a program to delete using ◀▶ buttons, then press the ENTER or ► buttons.
- 6 Select Yes to delete the program using ▲▼ buttons.
- 7 Selected program is deleted.

- ◆ Press the RETURN button to go back to the previous menu.
- ◆ Press the MENU button to close menu scene.

- ⚠ ◆ Live TV control will be stopped at the Edit mode.
- ◆ The program can be broken or erased in case of sudden power off or plug off during Edit mode (Combine, divide, delete, partial delete) using.



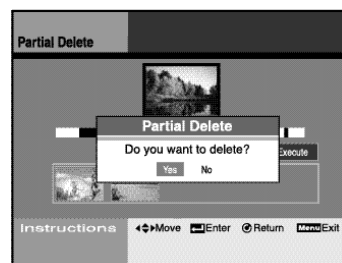
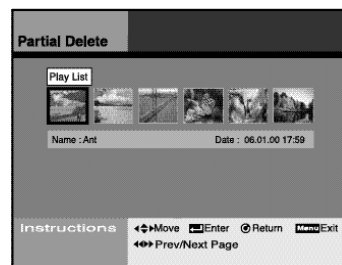
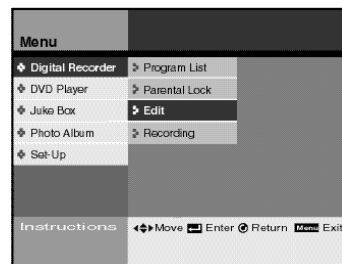

White : Unselected part
 Blue : Selected part
 Red : Current playback position

You can delete parts you want to skip like commercial.

- 1 Press the MENU button.
- 2 Select Digital Recorder, then press the ENTER or ► buttons.
- 3 Select Edit using ▲▼ buttons, then press the ENTER or ► buttons.
- 4 Select Partial Delete using ▲▼ buttons, then press the ENTER or ► buttons.
- 5 Select a program to delete using ◀▶ buttons, then press the ENTER or ► buttons.
- 6 Search parts you want to delete using ◀◀(REW), ▶▶(FF), ▶II (Play /Pause) buttons.
- 7 Press the ENTER button at start & end position to delete.
 - The selected part would be changed from white to blue color, and the first scene of blue part is displayed at bottom.
- 8 You can delete part of program by repeat step 7.
 - Up to 6 parts can be selected.

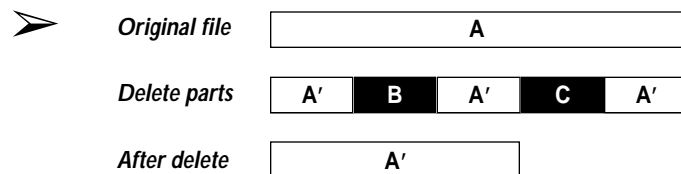

- ⚠
- ◆ Live TV control will be stopped at the Edit mode.
 - ◆ The program can be broken or erased in case of sudden power off or plug off during Edit mode (Combine, divide, delete, partial delete) using.
 - ◆ Make sure select the END point before move down to the Execute.

You can record TV programs in the HDD.

Make sure present time is set.

- 1 Press the MENU button.
- 2 Select Digital Recorder, then press the ENTER or ► buttons.
- 3 Select Recording using ▲▼ buttons, then press the ENTER or ► buttons.
- 4 Select Timer Recording, then press the ENTER button.
 - If clock was not set, then the popup menu is displayed. Set the present time using ▲▼◀▶ buttons, then it goes back to Timer recording menu automatically.

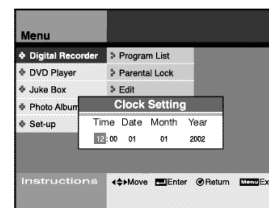

- 5 ENTER specific data to record using ▲▼◀▶ buttons.
 - Press the ENTER button to change or enter data.
 - Press clear button to delete programmed schedule.
- 6 Turn off the power after finishing the timer recording.

-
- ◆ See to page 42 to select recording quality(Speed).
 - ◆ If the current time is set, you can directly move the Timer Program mode by pressing the TIMER button on the remote control.

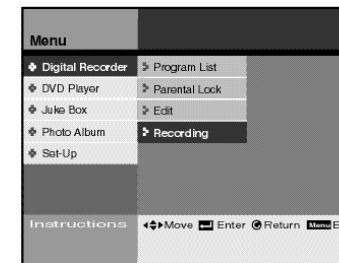
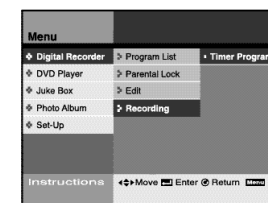

| Timer Prog | | | | | | |
|------------|-------|-------|-------|-------|-------|--------|
| No | Prog | Date | Start | End | Speed | Type |
| 01 | Super | 01/02 | 12:00 | 14:00 | SQ | Daily |
| 02 | PR01 | 02/05 | 10:00 | 02:00 | HQ | Weekly |
| 03 | PR02 | 11/10 | 05:00 | 10:00 | SHQ | Once |
| 04 | PR03 | 07/02 | 02:00 | 08:00 | SQ | Once |
| 05 | --- | --- | --- | --- | --- | --- |
| 06 | --- | --- | --- | --- | --- | --- |
| 07 | --- | --- | --- | --- | --- | --- |
| 08 | --- | --- | --- | --- | --- | --- |

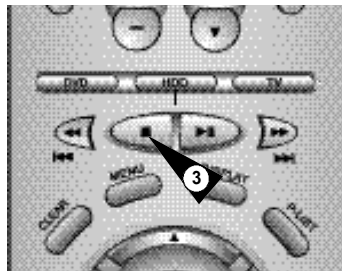
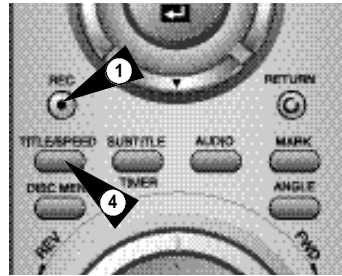

You can save watching TV program or DVD title in HDD.

- 1 Press the REC button to save current watching TV program or DVD title.
- 2 REC mark is displayed on the screen.
 - Recording contents will be saved automatically.
 - You can check saved programs in program list.
- 3 Press the ■ (STOP) button to finish recording.
- 4 Press Speed button to adjust recording quality. The higher quality is needed more space in HDD.
 - Change the recording quality before recording.
 - After starting record, you can not change quality.
 - SQ : Standard Quality (2Mbps/40Hr)
 - HQ : High Quality (4Mbps/20Hr)
 - SHQ : Super High Quality (6Mbps/13Hr)

Your DHR stops automatically after the requested length of time.

- 1 Switch on the television.
- 2 To monitor the programme being recorded, select the television channel reserved for use with your DHR (or the LINE input if used).
- 3 Select:
 - The station to be recorded using the PROG (▲ or ▼) buttons or
 - The LINE1, LINE2 source using the INPUT SEL. button for a satellite tuner or external video source
 - Result: The channel number is displayed and the programme can be seen on the television.
- 4 Hold the REC button (●) down for a while to start recording. Result: The record mark appears on the television screen.
- 5 Press the REC button (●) several times to increase the recording time:
 - From 30 min. to 8 hours
- 6 If you wish to cancel the recording before the end, press STANDBY/ON.

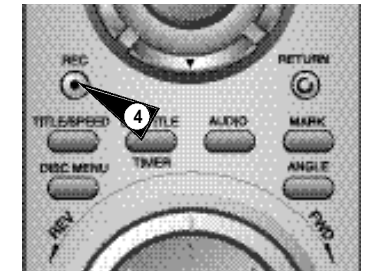
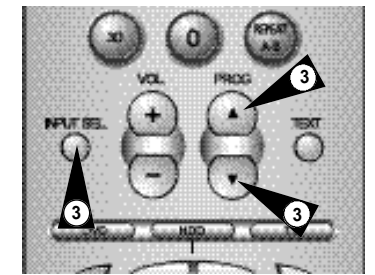

OTR 00:30

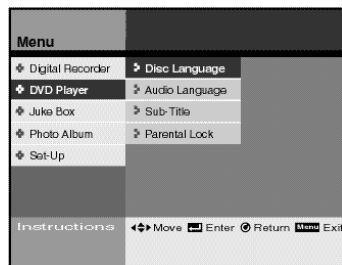

You can setup DVD title's language and rate.

Disc Language

You can select DVD title's menu language.
see page 46

Audio Language

You can select DVD title's audio language.
see page 46

Subtitle

You can select DVD title's subtitle language.
see page 46

Parental Lock

You can lock adult or violent DVD titles for children.
see page 47-48

➤ *The language change functions support only to multi-language menu included DVD titles.*

- ⚠ *Turn the power off and on again when the DHR works abnormal by sudden power off, plug off or not supported files, broken files in HDD.*
 - Abnormal working case : no key input except Standby/On button, flickering display panel.
 - Supported files in DHR : MP3, JPG.

You can copy DVD title to HDD.

Copy protected DVD titles will not be copied.

- 1 Insert DVD title to copy and change to DVD mode using DVD button on the remote control or on the front panel.
- 2 Press the Copy button on the front panel or the REC button on the remote control.
- 3 Press the ■ (STOP) button to finish copy.

- ♦ *After end of copy, "program"(file name) is created automatically.*
- ♦ *Copy protected titles can not be copied.*

⚠ *After 2 hours and 30 minutes copying, it stops automatically.*

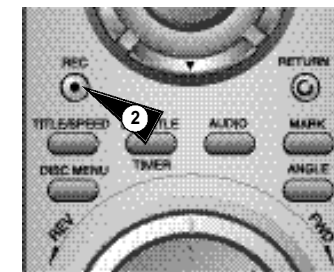
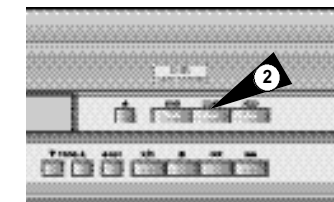

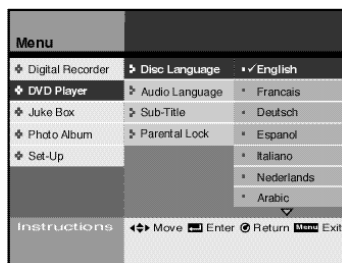
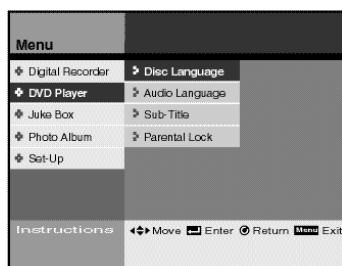
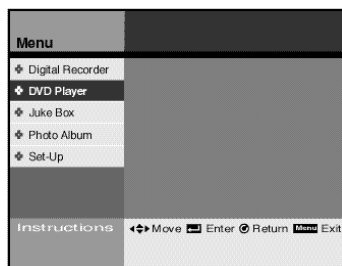

You can select language of DVD title's menu, audio, subtitle.

- 1 Press the MENU button.
- 2 Select DVD Player using ▲▼ buttons, then press the ENTER or ► buttons.
- 3 Select submenu you want to change using ▲▼ buttons, then press the ENTER or ► buttons.

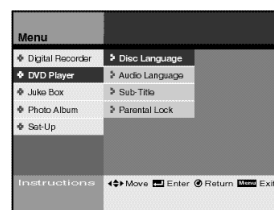

Disc language

DVD title's menu language selection.

Audio language

DVD title's audio language selection.

Sub-Title

DVD title's subtitle language selection.

- 4 Select language using ▲▼ buttons, then press the ENTER button.



- ◆ Press the RETURN button to go back the previous menu.
- ◆ Press the MENU button to close menu scene.

You can adjust DVD title's rating for children.

- 1 Press the MENU button.
- 2 Select DVD Player using ▲▼ buttons, then press the ENTER or ► buttons.
- 3 Select Parental Lock using ▲▼ buttons, then press the ENTER or ► buttons.
- 4 Enter a 4-digit password using the 0-9 buttons on remote control, then press the ENTER button.
 - Write your password down, and keep it in safe place in case you need it to change your setting later.
 - Initial password is set as 1111.
- 5 Select Lock setting using ▲▼ buttons, then press the ENTER or ► buttons.
- 6 Adjust rate using ▲▼ buttons, then press the ENTER button.
 - If you adjust rating up to 6 level, upper 7, 8 level titles are not played.
 - The higher level is the closer to adult or violent titles.

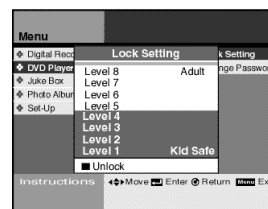

- ◆ This function supports only to DVD title's included rating information.
- ◆ This password is for DVD only and is different from the HDD password setting.
- ◆ See the page 65 when you forget the password.

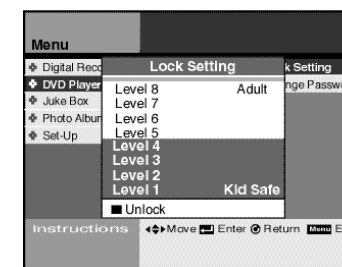
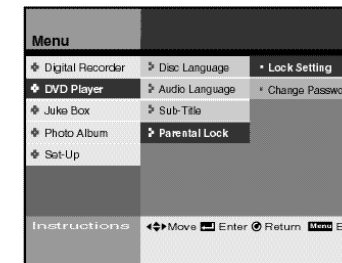
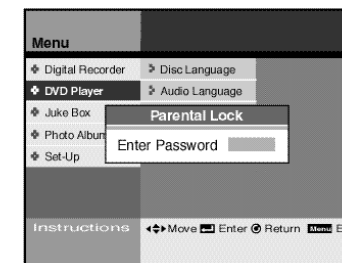
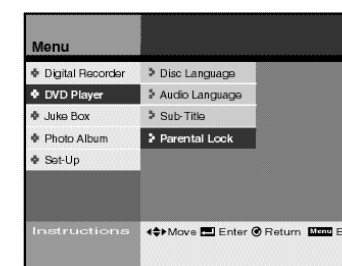
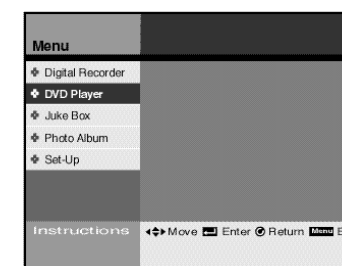

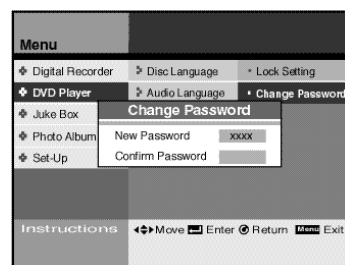
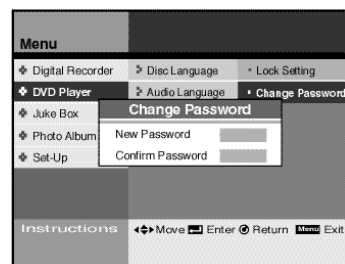
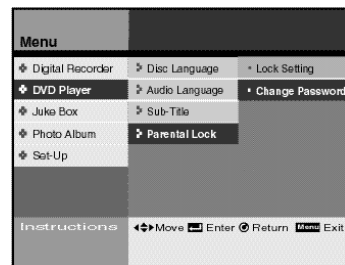

You can change password in Parental Lock menu.

- 1 Press the MENU button.
- 2 Select DVD Player, then press the ENTER or ► buttons.
- 3 Select Parental Lock using ▲▼ buttons, then press the ENTER button.
- 4 Enter a 4-digit password using the 0-9 buttons on remote control.
 - Write your password down, and keep it in a safe place in case you need it to change your setting later.
 - Initial password is set to 1111.
- 5 Select Change Password using ▲▼ buttons, then press the ENTER or ► buttons.
- 6 Enter new 4-digit password using the 0-9 buttons on the remote control.
- 7 Enter the new password again to confirm.

- ◆ If you press RETURN button, then change password procedure is cancelled.
- ◆ This password is for DVD only and is different from the HDD password setting.

Many DVDs feature their own menu system, where you can select Titles, Chapters, Audio Tracks, Subtitles, and special disc features, such as movie trailers, and information on the cast. Use these buttons to make selections in the Disc menus.

- 1 Press the DISC MENU button to access DVD's disc menu.
 - Move to DVD's disc menu.
- 2 Press the TITLE button to access DVD's title menu.
 - Move to DVD's title menu.

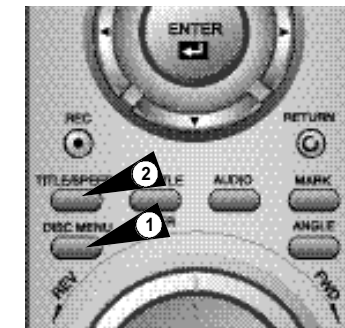

3D Audio is an enhanced audio mode that creates the illusion of Surround Sound with only two speakers.

- 1 During playback of a Disc, press the 3D button on the remote control.
- 2 Press the 3D button to set 3D SOUND On/Off.

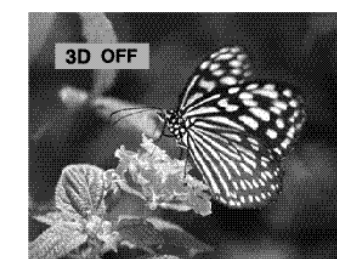
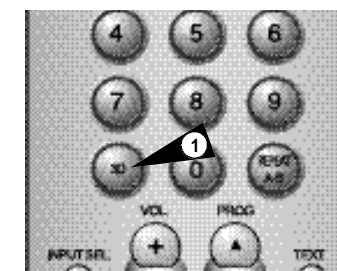

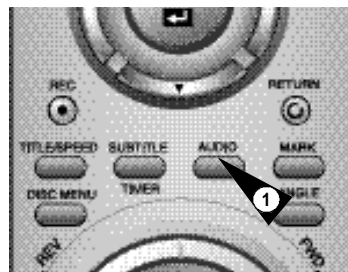

You can select a desired language quickly and easily with the AUDIO button.

- 1 Press the AUDIO button.
- 2 Select the desired language on DVD using ▲▼ buttons.
- 3 Select audio output mode(Stereo, Right, Left) on VCD/CD using ▲▼ buttons.

- This function depends on what languages are encoded on the disc and may not work with all DVDs.
- How to have the same audio language comes up whenever you play DVD titles ; See "Disc Language/Audio Language /Sub-Title" on page 46.

DVD

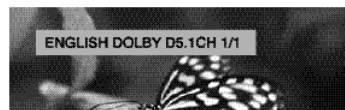

VCD/CD



You can select a desired subtitle quickly and easily with the subtitle button.

- 1 Press the SUBTITLE button.
- 2 Select the desired subtitle language using ▲▼ buttons.
- 3 Select subtitle On/Off using ◀▶ buttons.

- This function depends on what languages are encoded on the disc and may not work with all DVDs.
- How to make the same audio language comes up whenever you play DVD titles ;See "Disc Language/Audio Language/Sub-Title" on page 46.
- * If DVD titles have own languages, default disc's language comes out.



You check DVD title's status or select options.

- 1 Press the Display button during DVD playing.
- 2 Select submenu to change using ▲▼ buttons, then change option using ◀▶ buttons.

- If you would like to save changes or escape menu, press the Return or Display buttons again.
- The display submenu can be changed if you use VCD using.

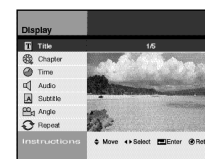
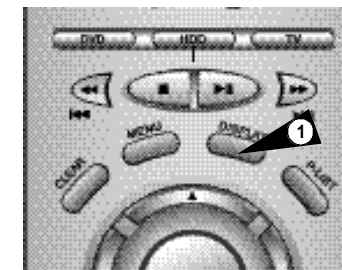

Title
Display current playback title's status and move to a title

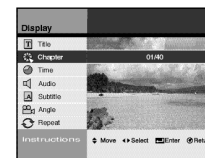

Chapter
Display current playback chapter's status and move to a chapter



Time
Display current playback time
Enter time using 0-9 buttons to more the scene, then press the ENTER button.

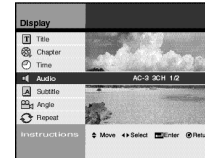

Audio
Display current audio language and change another

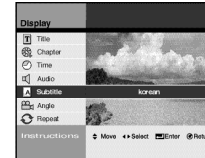

Subtitle
Display current subtitle language and change another



Angle
Change scene angles
This function supports only multi-angle scene included DVD titles.

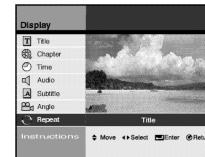

Repeat
Repeat title or chapter

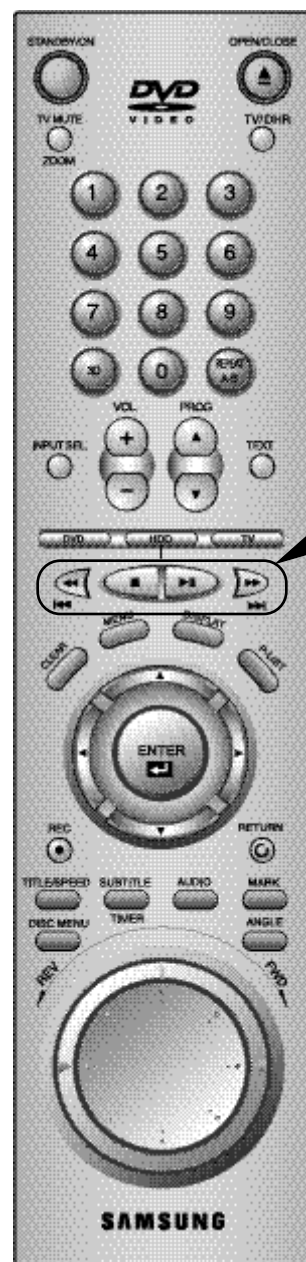

During DVD/CD playback you can select from the following special playback options. To resume normal playback, press the ►|| (PLAY/PAUSE) button.

Pause

Press the ►|| (PLAY/PAUSE) button on the remote control during playback.

- The picture will Pause and the audio will mute.
- To resume playback, press the ►|| (PLAY/PAUSE) button.
- If the player is left in Pause mode for 5 minutes, it will play automatically.

Frame Search (Step)

While in Pause mode, roll the jog on the remote control to forward/backward one frame at a time.

- Audio is muted during Frame search mode.
- Press ►|| (PLAY/PAUSE) to resume normal playback.

Forward/Backward Chapter Search

While a CD or DVD disc is in Play mode, press and hold the Skip Forward/Backward (►► / ◀◀) buttons on the remote control or front panel to jump forward and backward through disc chapters/tracks.

- Skip Forward will jump to the next chapter/track.
- Skip Back will jump to the beginning of the current chapter/track.
- Press the Skip Back button again to jump to the beginning of the previous chapter/track.

Forward/Backward Picture Search

While a disc is in Play mode, press and the Forward/Backward (►► / ◀◀) buttons on the remote control or front panel to visually search forward/backward at 2X - 4X - 8X - 16X - 32X - 64X - 128X speed. Press ►|| (PLAY/PAUSE) button to resume normal speed.

Slow Motion

During playback, press the ►|| (PLAY/PAUSE) button to Pause the image. Then use the Search Forward (►►) to play in slow motion at variable speeds.

- Each press increases the slow motion speed playback to 1/8, 1/4 or 1/2 of normal speed.
- Audio is muted during slow motion playback.
- Press the ►|| (PLAY/PAUSE) button to resume normal playback.

Stop/Resume

- Press the ■ (Stop) button ONCE to stop playback. Press ►|| (PLAY/PAUSE) button to resume the current stop position.
- Press the ■ (Stop) button TWICE to completely stop playback. The next time you press the ►|| (PLAY/PAUSE) button, the disc will start from the beginning.

The A-B Repeat function allows you to repeat any segment of a DVD or CD. Simply mark the beginning point (A) and the ending point (B) of the segment you want to review.

- 1 Press the REPEAT A-B button at starting position.
 - "A" will be selected when A-B repeat is selected.
 - "B" will be selected after pressing the REPEAT A-B button.
- 2 Repeat from "A" to "B".
- 3 Press the REPEAT A-B button again to cancel A-B repeat.

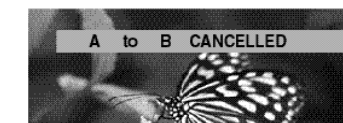

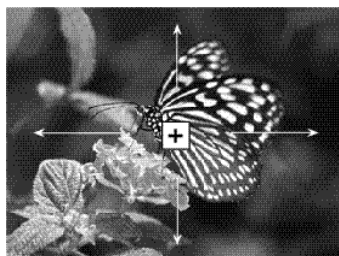

Zooms the scene to see more specific.

- 1 Press the Zoom button during playback or Pause mode.
- 2 Select part of screen to zoom using ▲▼◀▶ buttons, then press the ENTER button.
 - DVD : Normal/1.5X/2X/4X
 - VCD : Normal/1.5X/2X/4X
- 3 Press the ENTER button.
 - During DVD play : press ENTER to zoom in 1.5X/2X/4X/2X/1.5X/Normal in order.
 - During VCD play, press ENTER to zoom in 1.5X/2X/1.5X/Normal in order.



When a DVD contains multiple angles of a particular scene, you can use the Angle function.

Press the ANGLE button to see if an ANGLE (📷) mark is present at the upper right hand corner of the screen.

- 1 Press the Angle button when an angle icon is shown at the upper right hand corner, then angle selection icon will be appeared at the upper left hand corner.
- 2 Select desired screen angle using ◀▶ buttons.
- 3 To turn off the display, press the ANGLE button again.

The Bookmark function lets you select parts of a DVD or VCD (MENU OFF mode) so that you can quickly find the section at a later time.

- 1 Press the Mark button during playback.
- 2 Mark desired scene using the Enter button.
 - You can mark up to 3 scenes.
- 3 Press the Mark button again to turn off menu.
- 4 Press the Mark button to recall marked scenes, then select a scene(1, 2, or 3) using ◀▶, ▶|| buttons.
 - The marked scene will be played.
- 5 Delete Mark Number Select a mark number to delete using ◀▶ buttons, then press the Clear button.

-
- ◆ When in VCD 2.0 mode(Menu On mode), this function does not work.
 - ◆ The Bookmark function may not work depends on disc.

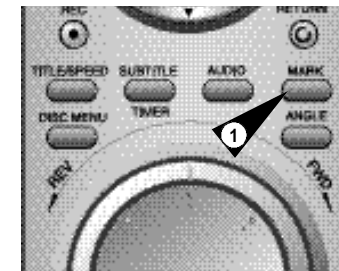

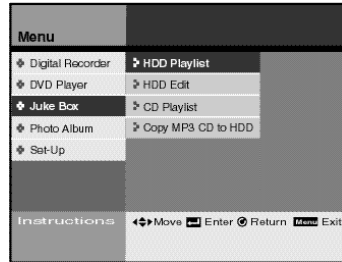

You can play MP3 files in HDD.
You also make your own play-list or edit MP3 files easily.

View the MP3 file list in HDD

You can display saved MP3 files list in HDD and play.
 see page 57

Edit the MP3 file in HDD

You can move, copy, save, or delete files and also change file name in HDD.
 see page 58

View the MP3 file list in CD

You can display MP3 files list in CD and play.
 see page 57

Copy MP3 file from CD to HDD

You can copy MP3 files from CD to HDD.
 see page 59



Turn the power off and on again when the DHR works abnormal by sudden power off, plug off or not supported files, broken files in HDD.

- Abnormal working case : no key input except Standby/On button, flickering display panel.
- Supported files in DHR : MP3, JPG.

You can display files on screen and play.

• HDD playlist is exactly same to CD Playlist in menu operation. Below step is an example of HDD Playlist.

- 1 Press the MENU button.
- 2 Select Juke Box using ▲▼ buttons, then press the ENTER or ► buttons.
- 3 Select HDD Playlist using ▲▼ buttons, then press the ENTER or ► buttons.
- 4 Select Folder or file using ▲▼ buttons, then press the ENTER button.
 - Press the ENTER button again to cancel file selection.



If you select folder, then it shows you included files in folder.

- 5 Press the P-LIST button.
 - The selected files are displayed in selected order and play the first file.
 - All files in the folder are selected when you press the P-LIST button after selecting a folder.

- 6 Select Repeat All using ◀▶ buttons, then press the ENTER button.
 - The selected MP3 files will be played continuously.

Select Slide Show using ◀▶ buttons, then press the ENTER button.

- The JPEG files will be displayed as a slide show during MP3 playing if JPEG files are in the same folder.
- Press the DISPLAY button to make full screen slideshow.



Press ■ button to Stop or to select other file.

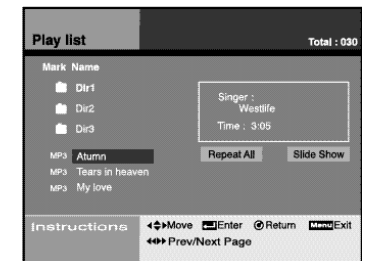
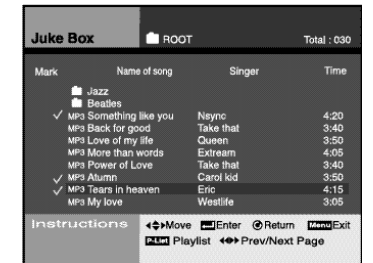
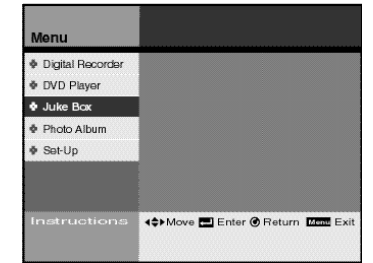

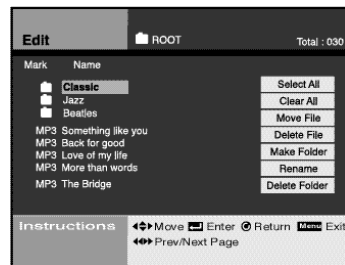
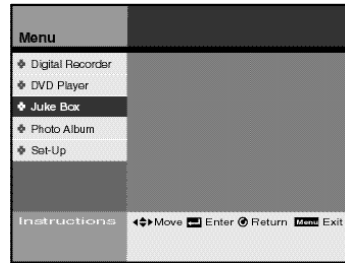

You can move, save, or delete files and also change file name in HDD.

- 1 Press the MENU button.
- 2 Select Juke Box using ▲▼ buttons, then press the ENTER or ► buttons.
- 3 Select HDD Edit using ▲▼ buttons, then press the ENTER or ► buttons.
- 4 Select folder or file using ▲▼ buttons, then press the ENTER button.
 - If you select files, then Check icon is displayed.
 - Press the ENTER button to cancel file selection.
 - If you select folder, then it shows you included files in the folder.
- 5 Move to the right side edit menu using ◀▶ buttons, then edit selected files using ▲▼◀▶, ENTER buttons.
- 6 In case of move :
Select folder to move using ▲▼ buttons, then press the ENTER button.
Select **Execute** using ◀▶ buttons, then press the ENTER button.

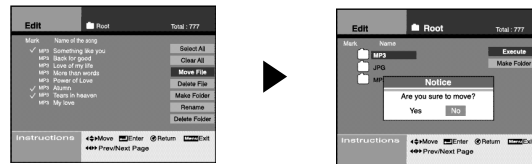

In case of making new folder :

1. Select **Make New Folder** using ▲▼ buttons, then press the ENTER button.
2. Enter a new folder name using ▲▼◀▶, ENTER buttons.
3. Press the RETURN button to cancel.
4. Select OK to save folder name on the virtual keyboard, then press the ENTER or RETURN button.
5. Press the CLEAR button to delete previous character.

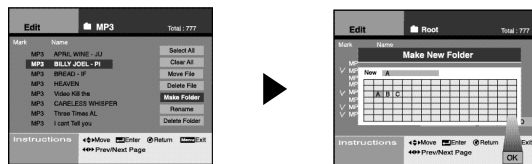

➤ You can make new folder only in the Root.

Select All

Select all files

Clear All

Unselect all files

Move file

Move files to another folder
And after move, existed file would be deleted.

Delete file

Delete files

Make Folder

Make new folder

Rename

Change file or folder name
Enter the new file or folder using ▲▼◀▶, ENTER buttons.

Delete Folder

Delete folder

You can copy MP3 files from CD to HDD.

- 1 Press the MENU button.
- 2 Select Juke Box using ▲▼ buttons, then press the ENTER or ► buttons.
- 3 Select Copy MP3 CD to HDD using ▲▼ buttons, then press the ENTER or ► buttons.
- 4 Select folder or files to copy from CD to HDD using ▲▼ buttons, then press the ENTER button.
 - Press the ENTER button again to cancel file selection.
- - If you would like to choose all files in folder, move to **Select All** using ◀▶ buttons, then press the ENTER button.
 - All files in the folder are selected when you press the P-LIST button after selecting a folder.
- 5 Select Copy to HDD using ◀▶ buttons, then press the ENTER button.

⚠ Up to 200 files can be copied at once.

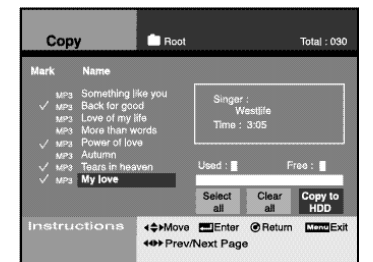
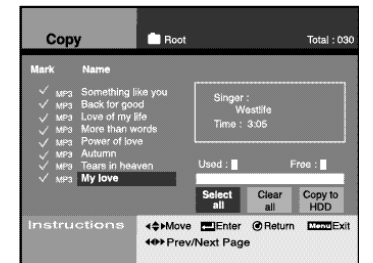
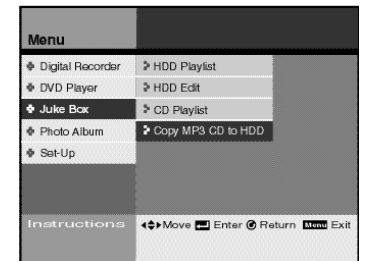
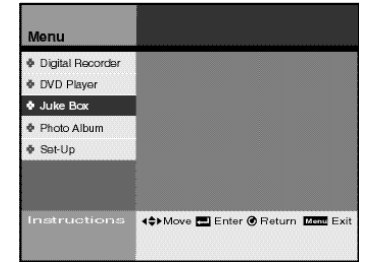



You can display JPEG files in CD or HDD and make your own Photo Album or edit JPEG files easily.

View the JPEG file list in HDD

You can display up to 8 JPEG files on a screen with thumbnail size or one JPEG file on a screen with full size. Also you can display JPEG files continuously thru slideshow function.

see page 61

Edit the JPEG file in HDD

You can move, copy, save, or delete files and also change file name in HDD.

see page 62

View the JPEG file list in CD

You can display JPEG files list in CD and display on screen.

see page 61

Copy JPEG file from CD to HDD

You can copy JPEG files from CD to HDD.

see page 63

! Turn the power off and on again when the DHR works abnormal by sudden power off, plug off or not supported files, broken files in HDD.

- Abnormal working case : no key input except Standby/On button, flickering display panel.

- Supported files in DHR : MP3, JPG.

You can display files on screen and play.

HDD playlist is exactly same to CD Playlist in menu operation. Below step is an example of HDD playlist.

- 1 Press the MENU button.
- 2 Select Photo Album using ▲▼ buttons, then press the ENTER or ► buttons.
- 3 Select HDD Playlist using ▲▼ buttons, then press the ENTER or ► buttons.
- 4 Select Folder or file using ▲▼ buttons, then press the ENTER button.
 - You can preview the selected file at the right side window.
 - Press the ENTER button again to cancel file selection.

➤ If you select folder, then it shows you included file's folder.

- 5 Press the P-LIST button.
 - 8 files are display.
-
- ◆ Select Next using ▲▼◀▶ buttons, then press the Enter button to see the next 8 files.
 - ◆ Select Previous using ▲▼◀▶ buttons, then press the Enter button to see the previous 8 files.

- 6 Select file to see using ◀▶ buttons, then press the ENTER button.
 - You can enlarge it to full screen size.
- 7 Select Slideshow using ▲▼◀▶ buttons, then press the ENTER button.
- 8 Select interval using ◀▶ buttons, then press the ENTER button.
 - Interval is from 3 sec to 10 sec.
- 9 Slide Show will be started for all JPEG files in playlist on the screen with full size.

-
- ◆ Press ▲▼◀▶ buttons to rotate pictures.
 - ◆ Press the ZOOM button to change picture scale. (Scale : 25%, 50%, 100%, 150%, 200%) Press the ENTER button to change scale.

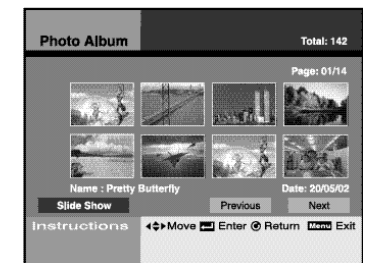
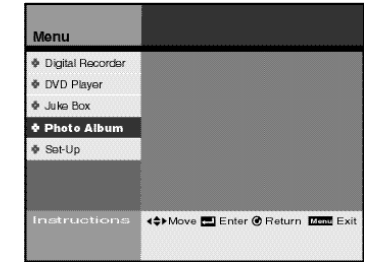

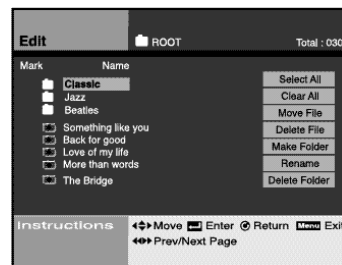
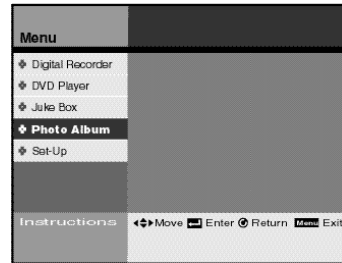

You can edit saved JPEG files in HDD.

- 1 Press the MENU button.
 - 2 Select Photo Album using ▲▼ buttons, then press the ENTER or ► buttons.
 - 3 Select HDD Edit using ▲▼ buttons, then press the ENTER or ► buttons.
 - 4 Select folder or file using ▲▼ buttons, then press the ENTER button.
 - If you select files, then Check icon is displayed.
 - Press the ENTER button to cancel file selection.
- If you select folder, then it shows you included files in the folder.
- 5 Move to the right side edit menu using ◀▶ buttons, then edit selected files using ▲▼◀▶, ENTER buttons.
 - 6 In case of move :
Select **Execute** using ▲▼ buttons, then press the ENTER button.

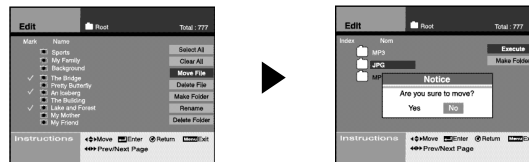

In case of making new folder :

1. Select **Make New Folder** using ▲▼ buttons, then press the ENTER button.
2. Enter a new folder name using ▲▼◀▶, ENTER buttons.
3. Press the RETURN button to cancel.
4. Select OK to save folder name on the virtual keyboard, then press the ENTER or RETURN button.
5. Press the CLEAR button to delete previous character.

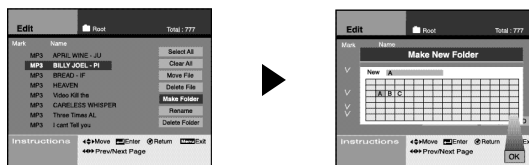

➤ You can make new folder only in the Root.

Select All

Select all files

Clear All

Unselect all files

Move file

Move files to another folder
And after move, existed file would be deleted.

Delete file

Delete files

Make Folder

Make new folder

Rename

Change file or folder name
Enter the new file or folder using ▲▼◀▶, ENTER buttons.

Delete Folder

Delete folder

You can copy JPEG files from CD to HDD.

- 1 Press the MENU button.
 - 2 Select Photo Album using ▲▼ buttons, then press the ENTER or ► buttons.
 - 3 Select Copy Photo CD to HDD using ▲▼ buttons, then press the ENTER or ► buttons.
 - 4 Select files to copy from CD to HDD using ▲▼ buttons, then press the ENTER button.
 - Press ENTER button to cancel file selection.
-
- If you would like to choose all files in folder, move to **Select All** using ◀▶ buttons, then press the ENTER button.
 - All files in the folder are selected when you press the P-LIST button after selecting a folder.
- 5 Select **Copy to HDD** using ◀▶ buttons, then press the ENTER button.

⚠ Up to 200 files can be copied at once.

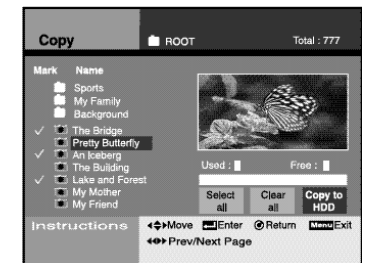
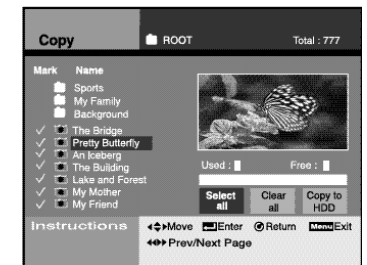
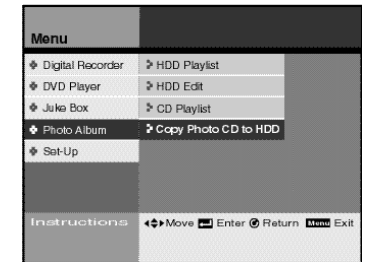
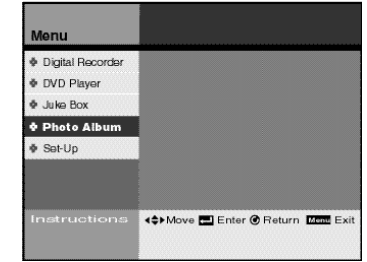

Technical Specifications

| | | |
|---------------------------------|-------------------------------|--|
| General | Rated voltage | 220 - 240V~, 50Hz |
| | Power consumption | 33 Watts |
| | Weight | 4.5 Kg |
| | Size | 430mm X 360mm X 70mm |
| | Operating ambient temperature | +5°C ~ +35°C |
| | Installation conditions | Operation position : Horizontal, Relative humidity : Below 75% |
| Input | Video (Rear) | RCA Jack 1 : 1.0Vp-p (unbalanced) 75 |
| | Audio (Rear) | RCA Jack 1 : -8dBm, 47K unbalanced |
| | Video (Front) | RCA Jack 2 : 1.0Vp-p (unbalanced) 75 |
| | Audio (Front) | RCA Jack 2 : -8dBm, 47K unbalanced |
| | Video (Rear) | S-Video |
| | Audio (Rear) | for S-Video using |
| Output | RF out | UHF 21-69 (Initial CH36) |
| | Audio | RCA Jack |
| | Audio | Digital audio out (OPTICAL, COAXIAL) |
| | Video | RCA Jack |
| | Video | S-Video COMPONENT : RCA Jack |
| HDD | CODEC Format | MPEG II |
| | REC Speed | SQ(2Mbps), HQ(4Mbps), SHQ(6Mbps) |
| | Color system | PAL for Video signal output |
| | Tuning system | B/G, D/K, I |
| | Video S/N | Above 43dB (standard recording) |
| | Resolution | Above 350 lines (standard recording) |
| | Audio S/N | Above 70dB (standard recording) |
| Audio frequency characteristics | 20Hz - 20KHz | |
| DVD | Disc | DVD, CD (12cm), CD (8cm), VIDEO-CD (12cm) CD-R (12cm), CD-RW (12cm) |
| | Audio S/N | 95dB |
| | Audio dynamic range | 105dB |

Problems and Solutions

1. No power

- Check that the power plug is connected to a wall outlet.
- Have you pressed the STANDBY/ON button?

2. When the power is turned on, the logo is displayed for some time before the picture appears.

- The DHR has a built-in hard disk drive (HDD). Because of the time required to initialize the hard disk drive, the logo will be displayed on the screen for about 15 seconds after power-on.

3. The television programme was not recorded

- Check the DHR aerial connections.
- Is the DHR tuner properly set?
- Check the HDD's free space.

4. Timer recording was unsuccessful

- Was the STANDBY/ON button pressed to activate the timer?
- Re-check the recording start/stop time setting.
- If there was a power failure or interruption during timer recording, the recording will have been cancelled.

5. The picture is paused or an earlier broadcast than the current time is showing.

- The DHR has the Time Shift function (see page 29) so that you can pause the incoming broadcast signal and resume watching the program later.
- Press the PLAY/PAUSE (▶||) button while watching a TV broadcast to pause the picture. To resume viewing the broadcast, press the ▶|| button again.
- If you press the ▶▶ button to watch the broadcast in real-time, the picture will be fast forwarded until incoming live broadcast is reached and played back at normal speed again.

6. The picture is played back at 2X speed in the reverse direction while watching a broadcast.

- The DHR has the Time-Shift function that allows you to instantly replay certain scenes from the current television programming. You can watch the program starting from as far back into the program as the time set in the Setup.
- Press the ◀◀ button to play back at 2X speed in the reverse direction during the reception of a TV program.

7. The Copy key is pressed, but does not respond.

- The copy function will only work with DVDs, but if they contain a copy-protection signal the copy operation cannot be performed.
- Discs other than DVDs, such as VCDs and CDs, cannot be copied.

8. The recorded video signals cannot be combined.

- The Combine operation is possible only on the files with the same record speed. That is, it doesn't work if one file is in SHQ mode and the other is in HQ mode.

9. I have forgotten the password.

- In the DVD mode, while "NO DISC" is displayed, press and hold down both the ■ and ▶|| buttons on the front panel at the same time for over 5 seconds to initialize the password to "1111".
- The password will be initialized to default, but the user setup will remain the same.

10. Disc does not play

- Ensure that the disc is installed with label side facing up.
- Check the region number of the DVD.
- This player cannot play some kinds of discs. (See page 12)

11. The ∅ icon appear or screen.

- The features or action cannot be completed at this because;
 - (1) The DVD's software restricts it.
 - (2) The DVD's software doesn't support the feature (e.g., angles).
 - (3) The feature is not available at the moment.
 - (4) You're requested a title or chapter number or search time that is out of range.

12. Playback mode differs from the Setup menu selection.

- Some of the function selected in the Setup Menu may not work properly if the disc is not encoded with the corresponding function.

13. The screen ratio cannot be changed.

- The screen ratio is fixed on your DVDs. (See page 31)

14. No audio.

- Make sure you have selected the correct Digital Output in the Audio Option Menu. (See page 30)

15. If you experience other problems.

- Go the contents and find the section of the instruction book that contains the explanations regarding the current problem, and follow the procedure once again.
- Turn the power off and on again.
- If the problem still cannot be solved, please contact your nearest authorized service center.