

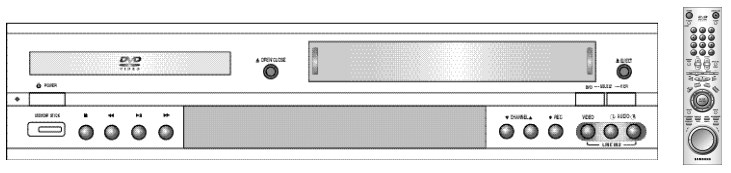

DVD-V2500

Instruction Manual



AK68-00006A



WARNING:

TO PREVENT DAMAGE WHICH MAY RESULT IN FIRE OR ELECTRIC SHOCK HAZARD, DO NOT EXPOSE THIS APPLIANCE TO RAIN OR MOISTURE.

WARNING:

TO AVOID HAZARDOUS EXPOSURE TO INVISIBLE LASER RADIATION, DO NOT OPEN OR REMOVE/DEFEAT LASER TRANSPORT PROTECTIVE HOUSING.

USER/INSTALLER CAUTION:

Your authority to operate this FCC certified equipment could be voided if you make changes or modifications not expressly approved by the manufacturer, who is responsible for compliance with Part 15 FCC rules.

NOTE TO CATV SYSTEM INSTALLER:

This reminder is provided to call the CATV system installer's attention to Article 820-40 of the National Electronic Code that provides guidelines for proper grounding and, in particular, specifies that the cable ground shall be connected to the grounding system of the building, as close to the point of cable entry as practical.



This symbol is intended to alert the user to the presence of uninsulated dangerous voltage within the product's enclosure that may be of sufficient magnitude to constitute risk of fire or electric shock.



This symbol is intended to alert the user to the presence of important operating and maintenance instructions in the literature accompanying this product.

Copy Notification

Federal law provides severe civil and criminal penalties for the unauthorized reproduction, distribution, or exhibition of copyrighted motion pictures and videotapes. (Title 17, United States Code, Sections 501 and 506).

Macrovision Notification

This product incorporates copyright protection technology that is protected by method claims of certain U.S. patents and other intellectual property rights owned by Macrovision Corporation and other rights owners. Use of this copyright protection technology must be authorized by Macrovision Corporation, and is intended for home and other limited viewing uses only unless otherwise authorized by Macrovision Corporation. Reverse engineering or disassembly is prohibited.

CAUTION:

To prevent fire, shock hazard, or annoying interference, use only the recommended accessories. To prevent electric shock, do not use this (polarized) plug with an extension cord, receptacle, or other outlet unless the blades can be fully inserted to prevent blade exposure. To reduce the risk of electric shock, do not remove the unit cover or back. There are no serviceable parts inside. Refer servicing to qualified personnel only.

CUIDADO:

Para prevenir incendio, riesgo de choque, o interferencia enfadosa, use solamente los accesorios recomendados. Para prevenir electrochoque, no use este enchufe (polarizado) con un cordón de extensión, toma de corriente, o cualquier otra toma a menos que los dientes puedan ser completamente insertados para prevenir exposición de los dientes. Para reducir el riesgo de descarga eléctrica, no remueva la cubierta o la parte posterior del equipo. Dentro del equipo no hay partes que requieran servicio. Dirijase solamente a personal calificado cuando requiera servicio.

ATTENTION:

Pour éviter les incendis, risque de chocs, ou interférences fâcheuses, employer seulement les accessoires recommandés. Pour éviter les chocs électriques, ne pas employer cette prise (polarisée) avec une rallonge, une prise de courant ou une autre sortie de courant à moins que les lames peuvent être insérées à fond pour l'exposition des lames. Pour réduire les risques de chocs électriques, ne pas retirer le couvercle ou l'arrière du module. Il n'y a pas de pièce utilisable à l'intérieur. Ne faire effectuer l'entretien que par un personnel qualifié.

Important Safety Instructions

1. Read these instructions.
2. Keep these instructions.
3. Heed all warnings.
4. Follow all instructions.
5. Do not use this apparatus near water.
6. Clean only with dry cloth.
7. Do not block any ventilation openings. Install in accordance with the manufacturer's instructions.
8. Do not install near any heat sources such as radiators, heat registers, or other apparatus (including amplifiers) that produce heat.
9. Do not defeat the safety purpose of the polarized or grounding-type plug. A polarized plug has two blades with one wider than the other. A grounding type plug has two blades and a third grounding prong. The wide blade or the third prong are provided for your safety. If the provided plug does not fit into your outlet, consult an electrician for replacement of the obsolete outlet.
10. Protect the power cord from being from being walked on or pinched particularly at plugs, convenience receptacles, and the point where they exit from the apparatus.
11. Only use attachments/accessories specified by the manufacturer.
12. Use only with cart, stand, tripod, bracket, or table specified by the manufacturer, or sold with the apparatus. When a used, caution when moving the cart/apparatus combination to avoid injury from tip-over.
13. Unplug this apparatus. When a cart is used, use caution when moving the cart/apparatus combination to avoid injury from tip-over.
14. Refer all servicing to qualified service personnel. Servicing is required when the apparatus has been damaged in any way, such as power-supply cord or plug is damaged, liquid has been spilled or objects have fallen into the apparatus, the apparatus has been exposed to rain or moisture, does not operate normally, or been dropped.

Table of Contents

◆ Safety	
■ Important Safety Instructions	3
◆ Feature Summary	
■ Feature Summary	7
■ Unpack	7
■ Disc Type and Characteristics	8
◆ 1 - System Overview	
■ Front Panel Overview	9
■ Rear Panel	10
■ Front Panel Display	10
■ Remote Control Overview	11
■ Insert Batteries into Remote	11
■ Using the TV Buttons on the Remote Control	12
◆ 2 - Getting Started	
■ Basic Connections/Auto Setup	13
◆ 3 - Basic Operation	
■ Deck Control Buttons	14
■ Basic DVD Operation	14
■ Basic VCR Operation	15
■ Basic TV Tuner Operations	16
◆ 4 - System Setup	
■ On-Screen Menu Navigation	16
■ Menu Language	17
■ Manual Clock Set	18
■ Tuner Band Setting	19
■ Auto Channel Memory	20
■ Channel Add/Delete	21
■ Auto Power Off	22
■ Front Panel Dimmer	23
■ RF Output Channel	23

Table of Contents

◆ 5 - DVD Setup	
■ Player Menu Language	24
■ Disc Menu Language	24
■ Audio Language	25
■ Subtitle Language	25
■ Parental	26
■ Digital Output	27
■ DTS	28
■ Dynamic Compression	29
■ 2X Scan Audio	30
■ TV Aspect Ratio	31
◆ 6 - DVD Sound Setup	
■ AV Receiver Connections	32
◆ 7 - DVD Operations	
■ Special Playback Features	33
■ Disc Menu Navigation	34
■ Screen Fit Playback	34
■ Title/Chapter/Time Selection	35
■ Zoom	36
■ Angle View	36
■ Subtitle	37
■ Audio	38
■ 3D Sound	38
■ Repeat Chapter/Title	39
■ Bookmarks	40
■ Programmed Playback	41
■ Random Playback	41
■ MP3 Playback	42
◆ 8 - Memory Stick	
■ Memory Stick	43
■ DAM (Digital Audio Manager) Playback	47
■ Memory Stick Pull out	48
■ DPM (Digital Photo Manager) Playback	49
■ Slide Show	50
■ Slide Show Order	51
■ Photo View	52
■ Edit Photo	53

Table of Contents

◆ 9 - VCR Playback	
■ Special VCR Playback Features	54
■ Tracking	54
■ Auto Play	55
■ S-VHS Playback	55
■ Variable Search System	56
◆ 10 - VCR Recording	
■ Basic Recording	57
■ Special Recording Features	58
■ One-Touch Recording (OTR)	59
■ Record Speed	59
◆ 11 - Timer Recording	
■ How to Set a Timer Recording	60
◆ Appendix A - Advanced Connections	
■ S-Video/Component Video Connections (for DVD)	61
■ Stereo Connections	62
■ Monitor TV Connections	63
■ Connecting Other Video Equipment	64
◆ Appendix B - Help	
■ Technical Specifications	65

Feature Summary

DVD+VCR Features

- Perfect compatibility to play back DVDs, VCDs, audio CDs, MP3 discs or VHS Tapes.
- Enjoy a DVD movie while recording a TV show to the VCR.
- Auto Setup instantly finds the time and runs channel search.
- RF inputs and outputs for all kinds of TVs available.
- Composite, S-Video, and Component video outputs..
- Universal remote provides the full operation on DVD+VCR.
- On-Screen Program (English/French/Spanish).

DVD Features

- 10-bit video digital to analog converter and 27MHz advanced digital filter.
- Playback of 96KHz/24-bit sources.
- DTS digital output for DTS-enhanced DVDs.
- Playback MP3 files from CD-ROM.
- Continued audio during 2x speed playback.

VCR Features

- Hi-Fi Stereo VCR.
- 4 heads for superior slow motion and stop action.
- Playback of S-VHS tapes at better than standard resolution.
- VISS Scan, Zero Return, Blank Search.
- 8-event/1 month timer recording.
- Time remaining counter, real time counter.

Note

*Discs which cannot be played with this player.

- DVD-ROM
- DVD-RAM
- CD-ROM
- CDV
- CDI
- SVC, CVD
- HD layer of super Audio CD
- CDGs play audio only, not graphics.

*Ability to play back may depend on recording conditions.

- DVD-R
- CD-RW
- DVD+RW, -RW
- Photo CD

Unpack

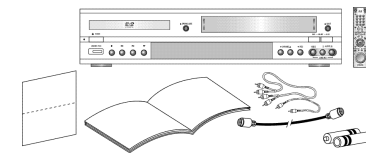

When you unpack the DVD+VCR, please check the following list of items is included in the packing case.

- DVD-VCR
- User's Guide
- RCA cable for Audio/Video connection
- RF (Radio Frequency) Antenna Cable
- Remote Control
- 1.5V "AA" Batteries - 2EA



Disc Type and Characteristics

This DVD player is capable of playing the following types of discs with the corresponding logos:

Disc Types (Logos)	Recording Types	Disc Size	Max. Playing Time	Characteristics
	Audio + Video	5"	Single-sided 240 min. Double-sided 480 min.	<ul style="list-style-type: none"> DVD contains excellent sound and video due to Dolby Digital and MPEG-2 system. Various screen and audio functions can be easily selected through the on-screen menu.
		3 1/2"	Single-sided 80 min. Double-sided 160 min.	
	Audio + Video	5"	74 min.	<ul style="list-style-type: none"> Video with CD sound, VHS quality & MPEG-1 compression technology.
		3 1/2"	20 min.	
	Audio	5"	74 min.	<ul style="list-style-type: none"> CD is recorded as a Digital Signal with better audio quality, less distortion and less deterioration of audio quality over time.
		3 1/2"	20 min.	

Disc Markings



Play Region Number

Both the DVD player and the discs are coded by region. These regional codes must match in order for the disc to play. If the codes do not match, the disc will not play.

The Region Number for this player is described on the rear panel of the player.

Front Panel Overview

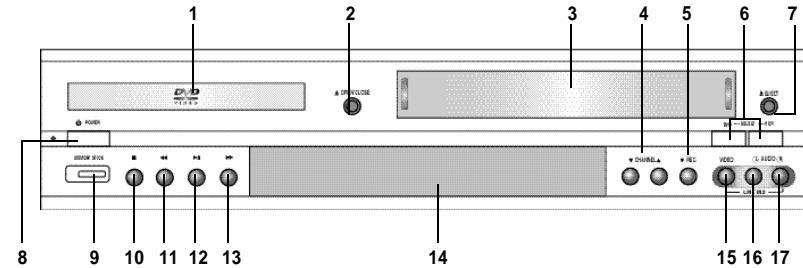

- | | |
|--------------------------|-----------------------------------|
| 1 DVD DECK (p.14) | 12 PLAY/PAUSE (p.14, 15, 33, 58) |
| 2 DVD OPEN/CLOSE (p.14) | 13 FAST-FORWARD/FWD (p.33, 54) |
| 3 VCR DECK (p.15) | 14 FRONT PANEL DISPLAY (p.10) |
| 4 CHANNEL ▲/▼ (p.16) | 15 LINE IN 2 COMPOSITE VIDEO JACK |
| 5 RECORD (p.57) | 16 LINE IN 2 LEFT AUDIO JACK |
| 6 DVD-VCR SELECT (p.14) | 17 LINE IN 2 RIGHT AUDIO JACK |
| 7 VCR EJECT (p.15) | |
| 8 POWER (p.14) | |
| 9 MEMORY STICK (p.43) | |
| 10 STOP (p.33) | |
| 11 REWIND/REV (p.33, 54) | |

Rear Panel

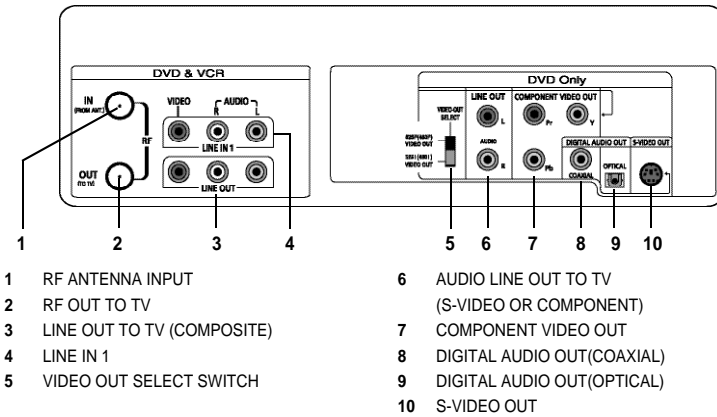

- | | |
|------------------------------|---|
| 1 RF ANTENNA INPUT | 6 AUDIO LINE OUT TO TV (S-VIDEO OR COMPONENT) |
| 2 RF OUT TO TV | 7 COMPONENT VIDEO OUT |
| 3 LINE OUT TO TV (COMPOSITE) | 8 DIGITAL AUDIO OUT(COAXIAL) |
| 4 LINE IN 1 | 9 DIGITAL AUDIO OUT(OPTICAL) |
| 5 VIDEO OUT SELECT SWITCH | 10 S-VIDEO OUT |

Front Panel Display

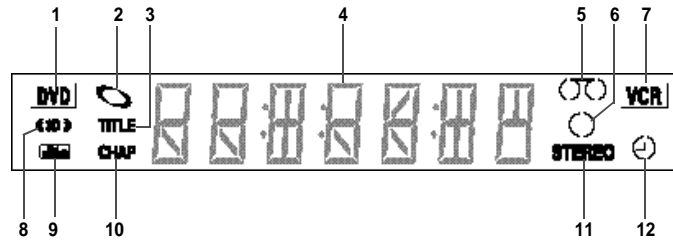

- | | |
|--|---|
| 1 When the light is on, DVD is operating | 8 3D Sound is active |
| 2 DVD, SVCD, VCD, or CD is loaded | 9 A DVD with a DTS soundtrack is loaded |
| 3 The number to the right of the "TITLE" symbol is the current title number | 10 The number displayed next to "CHAP" is the current chapter |
| 4 The time, counter position, time remaining or current deck status is displayed | 11 The Hi-Fi track of a VHS tape is playing (The current TV show or video is broadcast in Stereo) |
| 5 VHS is loaded | 12 Timer Recording is in progress. It also blinks when you pause VCR |
| 6 Clock hands is on when Timer Recording is in progress | |
| 7 VCR is working | |

10

Remote Control Overview

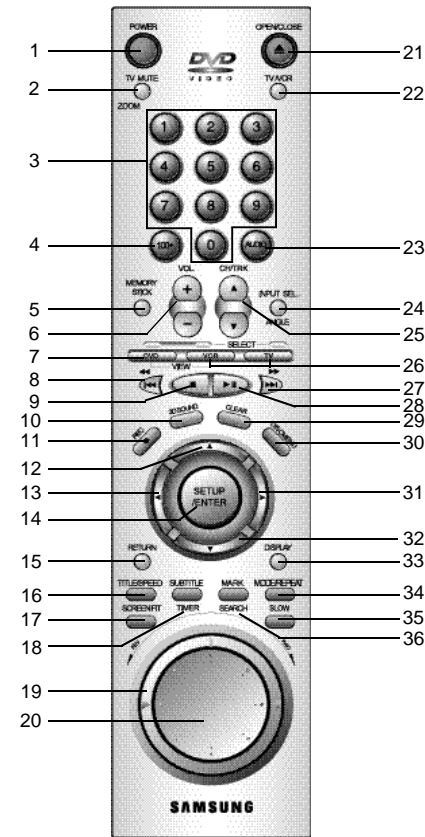

- | | |
|-------------------------------|---------------|
| 1 POWER (p.14) | 21 OPEN/CLOSE |
| 2 ZOOM (p.36), TV MUTE (p.12) | 22 TV/MOR |
| 3 0-9 (p.16) | |
| 4 100+(p.16) | |
| 5 MEMORY STICK (p.43) | |
| 6 VOLUME +/- (p.12) | |
| 7 DVD (p.14) | |
| 8 REWIND (p.33, 54) | |
| 9 SKIP BACK (p.33, 54) | |
| 10 STOP (p.33) | |
| 11 3D SOUND (p.38) | |
| 12 RECORD (p.57) | |
| 13 UP (p.16) | |
| 14 LEFT (p.16) | |
| 15 SETUP (p.16) | |
| 16 ENTER (p.16) | |
| 17 RETURN (p.16) | |
| 18 TITLE (p.35) | |
| 19 SPEED (p.59) | |
| 20 SCREEN FIT (p. 34) | |
| 21 SUBTITLE (p.37) | |
| 22 TIMER (p.60) | |
| 23 SHUTTLE DIAL (p.33) | |
| 24 JOG DIAL (p.33) | |
| 25 OPEN/CLOSE (p.14, 15) | |
| 26 TV/VCR (p.16) | |
| 27 AUDIO (p.38) | |
| 28 INPUT SEL. (p.57) | |
| 29 ANGLE (p.36) | |
| 30 CHANNEL ▲/▼ (p.12, 16) | |
| 31 TRACKING ▲/▼ (p.54) | |
| 32 VCR, TV SELECT (p.14) | |
| 33 FAST-FORWARD (p.33, 54) | |
| 34 SKIP NEXT (p.33, 54) | |
| 35 PLAY/PAUSE (p.14, 15) | |
| 36 CLEAR (p.40, 41) | |
| 37 DISC MENU (p.34) | |
| 38 RIGHT (p.16) | |
| 39 DOWN (p.16) | |
| 40 DISPLAY (p.35) | |
| 41 MODE (p.41) | |
| 42 REPEAT (p.39,54) | |
| 43 SLOW | |
| 44 MARK (p.40) | |
| 45 SEARCH (p.56) | |

Insert Batteries into Remote

- Remove the batter cover on the remote
- Insert two 1.5V "AA" batteries as shown, making sure of the correct polarities(+/-)
- Slide the cover back onto remote.

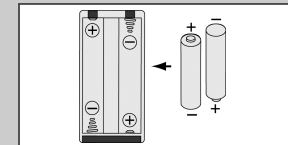

11

Using the TV Buttons on the Remote Control

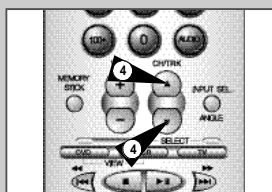
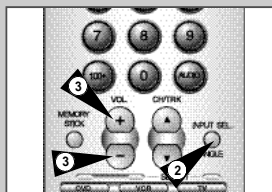

Your VCR remote control will work with Samsung televisions and compatible brands.

To determine whether your television is compatible, follow the instructions below.

- 1 Switch your television on.
- 2 Point the remote control towards the television.
- 3 Hold down the TV button and enter the two-figure code corresponding to the brand of your television, by pressing the appropriate numeric buttons.

Brand	Codes	Brand	Codes
SAMSUNG	01, 14, 15, 23	LOEWE	28
SHARP	02, 16, 22	ZENITH	17
SONY	03	LG	06, 08, 18
RCA	07, 29	MAGNAVOX	04
TOSHIBA	09	EMERSON	21
PANASONIC	12, 24	SANYO	05, 20
JVC	11	DAEWOO	19
HITACHI	10	NOBLEX	25
MITSUBISHI	13	TELEFUNKEN	26
NEWSAN	27		

Result: If your television is compatible with the remote control, it will switch off. It is now programmed to operate with the remote control.

- If several codes are indicated for your television brand, try each one in turn until you find one that works.

✎ When you change the batteries in the remote control, you must reprogram the code, following the same procedure.

You can then control the television using the following buttons.

Button	Function
POWER ①	Used to switch the television on and off.
INPUT SEL. ②	Used to select an external source.
VOL + or - ③	Used to adjust the volume of the television.
CH (▲ or ▼) ④	Used to select the required channel.
MUTE ⑤	Used to toggle the sound on and off.

- The various functions will not necessarily work on all televisions. If you encounter problems, operate the television directly.

Basic Connections/Auto Setup

In this section, you will connect the DVD-VCR to your television and run Auto Setup, which automatically searches for channels and sets the player's internal clock.

NOTES:

- See Appendix A for Advanced Connections.
- Standard RF or Line connection between DVD-V2500 & your TV are required to run DVD+VCR setup menu, even if you connect S-Video or Component Video Output for a better picture quality.

1 Connect Antenna/Cable to DVD+VCR

Connect an external indoor/outdoor antenna or wall outlet antenna cable to the Ant-In jack on the rear panel of DVD-V2500.

2 Connect DVD+VCR to TV

Choose one of the following methods to connect the DVD-VCR to your TV:
RF Connection
 Connect the supplied RF antenna cable from the OUT (TO TV) jack on the back panel of the DVD-VCR to your television's Antenna Input.

Line Connection

Connect an RCA-type audio/video cable (red, white, yellow) from the LINE OUT jacks on the back panel of the DVD-VCR to your television's Line In jacks. Use red for right audio, white for left audio, and yellow for video.

NOTE: It is recommended that you use the Line Connection if your TV is equipped with RCA jacks.

3 Plug In

Connect the DVD-VCR power cord to a standard 120V/60Hz wall outlet. Don't press any buttons on the DVD-VCR or remote during auto setup. "AUTO" blinks while the DVD-VCR runs an auto setup procedure, where it will automatically search for all active channels and set the clock. When Auto setting has been completed, the front panel displays the current time. If Auto Clock set is unable to find a channel to set the clock, you can set the clock manually; See page 18.

4 Turn On DVD+VCR

Press the POWER button on the remote control or on the DVD-VCR's front panel.

5 Turn On TV

Press the POWER button on your TV.

6 Set TV to Channel 3, 4 or Line

Be sure to use the same channel you selected in Step 2. If you used the Line Connection, set your TV to its Line Input.

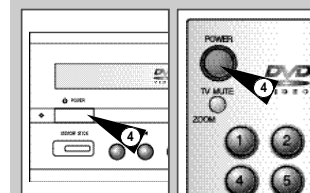
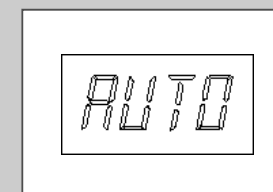
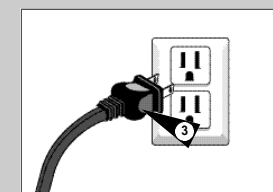
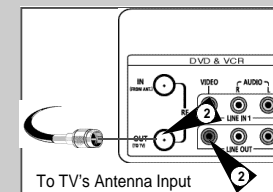
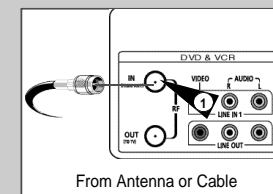

Deck Control Buttons

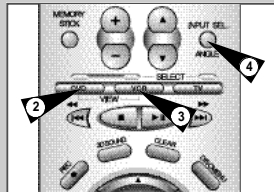

The DVD-VCR uses one set of controls to operate both decks. The following buttons are helpful in successfully controlling each deck.

- 1 POWER Button**
Press the POWER button on the remote control or front panel to turn on the DVD-VCR.
- 2 DVD Button**
Press the DVD button on the remote control or front panel when you want to control the DVD deck.
 - The DVD indicator will light on the Front Panel Display to show that the DVD deck is selected.
- 3 VCR Button**
Press the VCR button on the remote control or front panel when you want to control the VCR deck.
 - The VCR indicator will light on the Front Panel Display to show that the VHS deck is selected.
- 4 INPUT SEL. Button**
Press the INPUT SEL. button repeatedly to cycle through all of your input sources, including the Tuner (Ch##), Line 1 (rear AV input), and Line 2 (front AV input).
 - Input Select is only available when the VCR deck is selected.

Basic DVD Operation

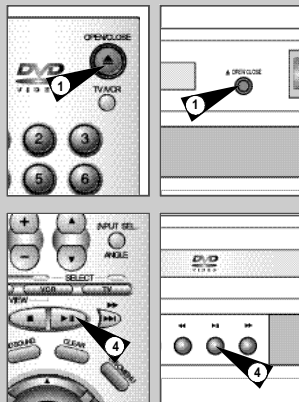

Follow the instructions below to playback a DVD.

- 1 Open the Disc Tray**
Press the Open/Close button on your remote or front panel to both power-on and open the tray.
- 2 Insert a Disc**
Put a disc in the center of the tray, with the label-printed side facing up.
- 3 Close the Disc Tray**
Press the Open/Close button on your remote or front panel to close the tray.
- 4 Play a DVD**
Press the Play/Pause button on your remote or front panel.
 - Most discs will start to playback as soon as the tray closes.
 - If a DVD has a disc menu, the menu may pop up on TV screen.
- 5 Additional DVD Options**
 - For advanced DVD Setup options, see pages 24-31.
 - For special DVD Playback features, see pages 33-42.

Basic VCR Operation

To play a videotape, simply insert it in the VHS deck and press the Play button. Tapes without Record Safety Tabs can be set to play automatically when inserted; see page 56.

- 1 Insert VHS Tape**
Insert a standard VHS videotape into the VHS Deck.
 - Power will turn on automatically when you insert a videotape.
- 2 Play Tape**
Press the ►|| (Play/Pause) button on the remote control or front panel. If the tape is missing the Record Safety Tab and Auto Play is turned on, the tape will begin to play automatically, see page 56.
- 3 Stop Playback**
Press the ■ (Stop) button on the remote control or front panel.
- 4 Eject Tape**
Press the OPEN/CLOSE button on the remote control or the EJECT button on the front panel.
- 5 Additional VCR Options**
 - For special VCR Playback features, see pages 54-56.
 - For VCR Recording features, see pages 57-60.
 - For Timer Recording features, see page 60.

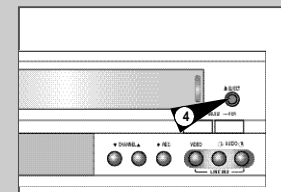
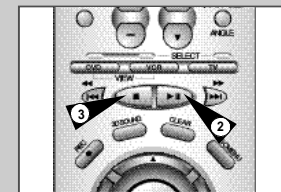
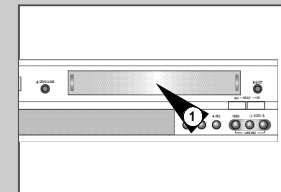
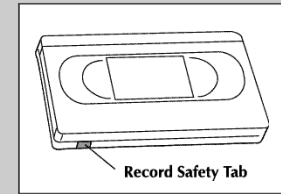

Basic TV Tuner Operations

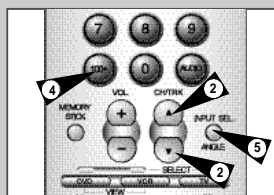
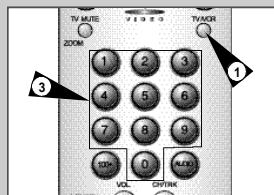

The following buttons are used when watching television via the DVD-VCR's built-in TV tuner.

- 1 TV/VCR**
Press to switch between your TV's tuner and the VCR's internal tuner.
- 2 Channel Up/Down**
Press to change to the next or previous channel.
- 3 0-9 Buttons**
Press to select channels directly.
- 4 100+ Button**
Press to select channels 100 and higher. First, press the 100+ button, then press the remaining digits using the 0-9 buttons.
- 5 Display**
Press to display the channel you are watching.
 - Also works in DVD and VCR mode.

On-Screen Menu Navigation

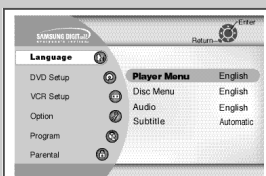

The Setup Menu is the opening screen of the on-screen menu system

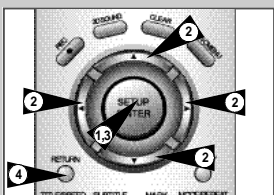

The on-screen menu system allows you to set all functions for your DVD-VCR. The following buttons are used to open and navigate through the on-screen menu system.

- 1 SETUP Button**
With the DVD in stop mode, press to access the DVD-VCR on-screen menu system.
- 2 Up/Down and Left/Right**
Moves menu selection cursor up, down, left and right to cycle through menu options
- 3 ENTER Button**
Press to confirm settings in certain menus.
- 4 RETURN Button**
Returns to the last menu viewed or exits the menu system.

Menu Language

Follow these steps to change the on-screen menu language to English, French or Spanish.

- 1 Open "SETUP MENU"**
With the DVD in stop mode, press the SETUP button.
- 2 Set "Language"**
Using the Up and Down buttons, move the selection arrow to "Language/Idioma/Langue," then press the ENTER button.
- 3 Set menu Language**
Move the selection bar to your desired Language, then press the ENTER button.

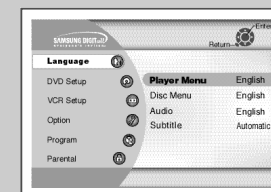
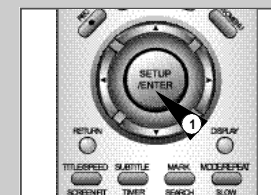

Manual Clock Set

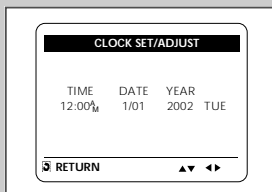
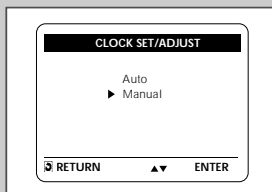
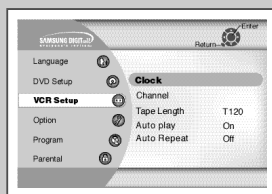
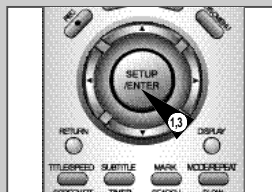

If Auto Setup was unable to find a local TV station to set the DVD-VCR's internal clock, follow these instructions to set the date/time manually.

NOTE: It is important to set the clock for accurate Timer Recording.

- Open "SETUP MENU"**
With the DVD in stop mode, press the SETUP button.
- Select "VCR Setup"**
Using the up and down buttons, move the selection cursor to "VCR Setup," then press ENTER to select.
- Select "Clock"**
Using the up and down buttons, move the selection cursor to "Clock Set/Adjust," then press ENTER to select.
- Select "MANUAL"**
Move the selection arrow to "MANUAL", then press ENTER to turn this feature "On."
 - The "Set Clock Menu" will change as shown.
- Set the Clock**
Press LEFT/RIGHT to select each of the following options, then press UP/DOWN to set each option:
 - Set Hour** – Set the hour using the up and down buttons.
 - Set Minute** – Set the minute using the up and down buttons.
 - Set Month** – Set the month using the up and down buttons.
 - Set Day** – Set the day using the up and down buttons.
 - Set Year** – Set the year using the up and down buttons.
- Confirm Settings**
Press the RETURN button to save your clock settings and return to the Setup menu.
 - Press Return again to exit.

Tuner Band Setting

This feature allows you to manually set the DVD-VCR's tuner band to Antenna or Cable, whichever you connected to the Antenna In jack during initial setup.

• Use this setting only if Auto Setup detected the incorrect tuner band, i.e. channels are coming in on the wrong channel numbers.

- Open "SETUP MENU"**
With the DVD in stop mode, press the SETUP button.
- Select "VCR Setup"**
Using the up and down buttons, move the selection cursor to "VCR Setup," then press ENTER to select.
- Select "Channel"**
Using the up and down buttons, move the selection cursor to "Channel", then press ENTER to select.
- Select "Ant/Cable"**
Move the selection arrow to "Ant/Cable" then press right to select from the following options:
 - Antenna - Indicates that the DVD-VCR is connected to an indoor or outdoor VHF/UHF antenna.
 - Cable TV - Indicates that the DVD-VCR is connected to Cable TV.

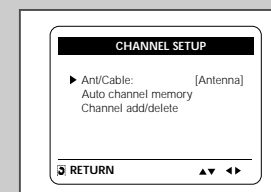
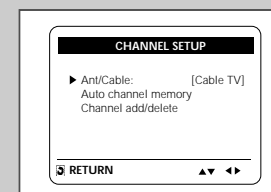
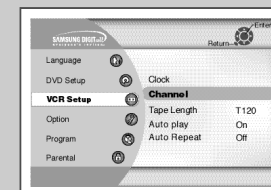
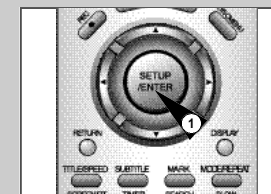

Auto Channel Memory

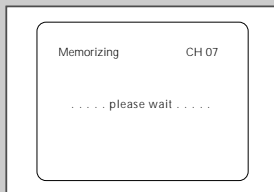
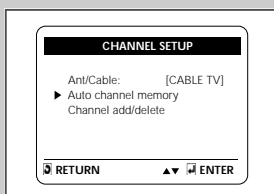
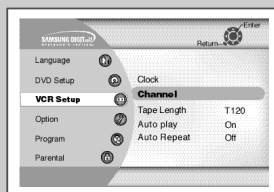
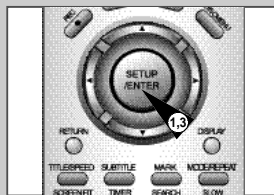

Auto Channel Memory will automatically seek and store all active channels in your area.

- 1 Open "SETUP MENU"**
With the DVD in stop mode, press the SETUP button.
- 2 Select "VCR Setup"**
Using the up and down buttons, move the selection cursor to "VCR Setup," then press ENTER to select.
- 3 Select "Channel"**
Using the up and down buttons, move the selection cursor to "Channel", then press ENTER to select.
- 4 Run "Auto channel memory"**
Move the selection arrow to "Auto channel memory," then press ENTER to select.
 - The DVD-VCR will automatically search for all available channels in the selected Tuner Band. This procedure may take a few minutes to complete.
 - When finished, the lowest channel found will be displayed.

Channel Add/Delete

Use this feature if Auto Channel Search missed a channel that you would like to add, or added a channel you wish to remove.

- 1 Open "SETUP MENU"**
With the DVD in stop mode, press the SETUP button.
- 2 Select "VCR Setup"**
Using the up and down buttons, move the selection cursor to "VCR Setup," then press ENTER to select.
- 3 Select "Channel"**
Using the up and down buttons, move the selection cursor to "Channel", then press ENTER to select.
- 4 Select "Channel add/delete"**
Move the selection bar to "Channel add/delete," then press ENTER to select.
- 5 Select Channel to add/delete**
Use the CH ▲/▼ buttons to tune in the channel number you wish to add or remove.
 - Repeat steps 4 and 5 to add or remove additional channels.
- 6 Select "CHANNEL ADD/DELETE"**
Press right to add or press left to remove the channel from your channel list.

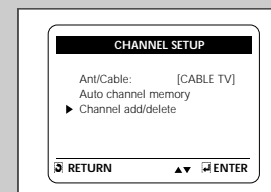
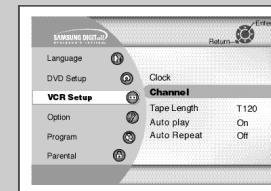
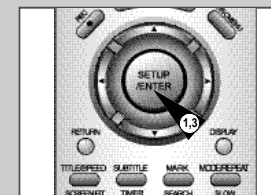

Auto Power Off

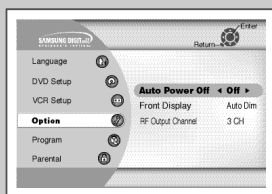
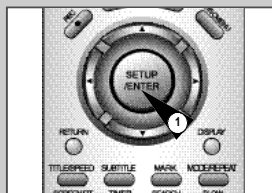

- 1 Open "SETUP MENU"**
With the DVD in stop mode, press the SETUP button.
- 2 Select "Option"**
Using the up and down buttons, move the selection cursor to "Option," then press ENTER to select.
- 3 Select "Auto Power Off"**
Move the selection bar to "Option Setup," then press right to select from following options:
 - Off – Auto power off is disabled.
 - 1Hr – DVD-VCR will auto shut off 1 hour after the last button is pressed.
 - 2Hr – DVD-VCR will auto shut off 2 hours after the last button is pressed.

Front Panel Dimmer

You can set the Front Panel Display to be bright all the time, dim all the time, dim during power off.

- 1 Open "SETUP MENU"**
With the DVD in stop mode, press the SETUP button.
- 2 Select "Option"**
Using the up and down buttons, move the selection cursor to "Option," then press ENTER to select.
- 3 Set "Panel Display"**
Move the selection bar to "Panel Display," then press right to select from the following options:
 - Auto dim– Front Panel Display will dim automatically during power off.
 - Dim – Front Panel Display will be dim all the time.
 - Bright – Front Panel Display will be bright all the time.

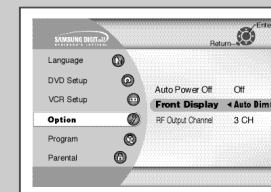

RF Output Channel

- 1 Open "SETUP MENU"**
With the DVD in stop mode, press the SETUP button.
- 2 Select "Option"**
Using the up and down buttons, move the selection cursor to "Option" then press ENTER to select.
- 3 Select "RF Output Channel"**
Move the selection bar to "RF Output Channel", then press right to change.
- 4 Change "RF Output Channel"**
Press Return to change. A message will appear on your TV. Then press ENTER to change.
- 5 Change "TV Channel"**
A message will appear on your TV. When the message disappears, change your TV to channel 3 or 4 to match the RF output channel of the player.

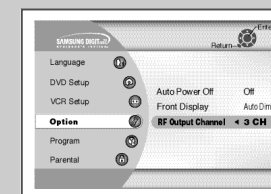
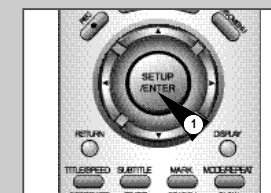

Player Menu Language

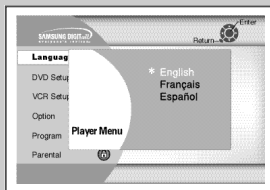
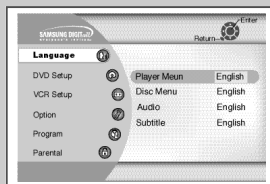

Follow these steps to choose preferred language for player menus. The DVD-VCR will automatically default to the language you choose if it is available on a given DVD.

- 1 Open "SETUP MENU"**
With the DVD in stop mode, press the SETUP button.
- 2 Select "Language"**
Using the up and down buttons, move the selection cursor to "Language," then press ENTER to select.
- 3 Select "Player Menu"**
Move the selection bar to "Player Menu," then press ENTER to select.
- 4 Set "Player Menu Language" Preference**
Move the Selection bar to your preferred language for "DVD Player Menu" disc menus, then press ENTER to select.

Disc Menu Language

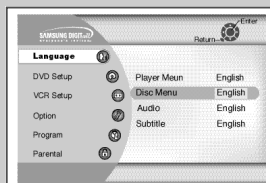

Follow these steps to choose your preferred language for DVD disc menus. The DVD-VCR will automatically default to the language you choose if it is available on a given DVD.

- 1 Open "SETUP MENU"**
With the DVD in stop mode, press the SETUP button.
- 2 Select "Language"**
Using the up and down buttons, move the selection cursor to "Language," then press ENTER to select.
- 3 Select "Disc Menu"**
Move the selection bar to "Disc Menu," then press ENTER to select.
- 4 Set "Disc Menu Language" Preference**
Move the selection bar to your preferred language for DVD disc menus, then press ENTER to select.

Audio Language

Follow these steps to choose your preferred language for DVD audio soundtracks. The DVD-VCR will automatically default to the language you choose if it is available on a given DVD.

- 1 Open "SETUP MENU"**
With the DVD in stop mode, press the SETUP button.
- 2 Select "Language"**
Using the up and down buttons, move the selection cursor to "Language," then press ENTER to select.
- 3 Select "Audio"**
Move the selection bar to "Audio," then press ENTER to select.
- 4 Set "Audio Language" Preference**
Move the selection bar to your preferred language for DVD audio soundtracks, then press ENTER to select.

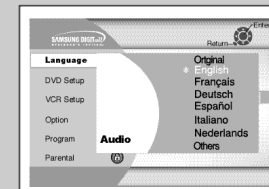
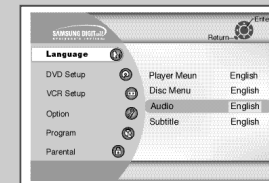

Subtitle Language

Follow these steps to choose your preferred language for DVD subtitles. The DVD-VCR will automatically default to the language you choose if it is available on a given DVD.

- 1 Open "SETUP MENU"**
With the DVD in stop mode, press the SETUP button.
- 2 Select "Language"**
Using the up and down buttons, move the selection cursor to "Language," then press ENTER to select.
- 3 Select "Subtitle"**
Move the selection bar to "Subtitle," then press ENTER to select.
- 4 Set "Subtitle Language" Preference**
Move the selection bar to your preferred language for DVD subtitles, then press ENTER to select.

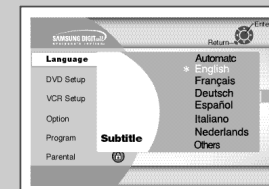
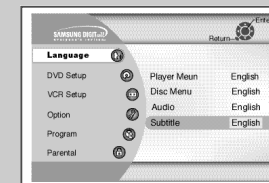

Parental

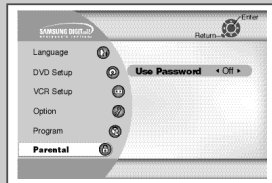

Rating Control is a password protected system that allows you to block playback of DVDs based on their content. The system uses an eight level rating system.

- If you try to play a DVD that exceeds the selected rating, an error message will appear.
- Not all discs are rated.

1 Open "SETUP MENU"

With the DVD in stop mode, press the SETUP button.

2 Select "Parental"

Using the up and down buttons, move the selection cursor to "Parental," then press ENTER to select.

3 Select "Use Password"

Move the selection arrow to "Use Password," then press the right/left button to select from the following options:

- Off - Indicates that no password is required to view any DVD disc or to change Rating Control options. No additional Rating Control settings are necessary.
- On - Indicates that a password is required to view some DVD discs and to view Rating Control options. The menu will change as shown.

NOTES:

- The first time "Enter Password" is set to "On," you will be prompted to enter a new password.
- If the "Enter Password" screen appears, then "Re-enter Password" has already been set to "Yes." Please skip to Step 5.

4 Enter Password

Enter a 4-digit password using the 0-9 buttons on the remote control.

- Write your password down, and keep it in a safe place in case you need it to change your settings later.

5 Select "Rating Level"

Move the selection bar to "Rating Level," then press ENTER to select.

6 Change Rating Level

Use the up/down buttons to select one of the following ratings:

- Level 8 Adult
- Level 7
- Level 6
- Level 5
- Level 4
- Level 3
- Level 2
- Level 1 Kids Safe

All ratings above the level you select will also be blocked, e.g., if you block Level 6, then Levels 7 and 8 will also be blocked. Press ENTER to confirm your selection.

- If you forgot your password, press power on from a cold start with no disc in the unit. Press the REW and F.F buttons simultaneously on the front panel for 5 seconds.

Digital Output

If your A/V receiver is equipped with a Dolby Digital decoder, your DVD-VCR can output Dolby Digital 5.1 sound, but you MUST enable this feature in the menu system to prevent damage to your speakers.

NOTE: Select "Bitstream" ONLY if you have connected a Dolby Digital-equipped A/V receiver to the Digital Output (optical or coaxial) on the DVD-VCR back panel.

1 Open "SETUP MENU"

With the DVD in stop mode, press the SETUP button.

2 Select "DVD Setup"

Using the up and down buttons, move the selection cursor to "DVD Setup," then press ENTER to select.

3 Set "Digital Output"

Move the selection bar to "Digital Output" then press the right/left button to select from the following options:

- PCM - To use your DVD/TV with an A/V receiver NOT equipped with a Dolby Digital decoder.
- Bitstream - To use your DVD/TV with an A/V receiver equipped with a Dolby Digital decoder.

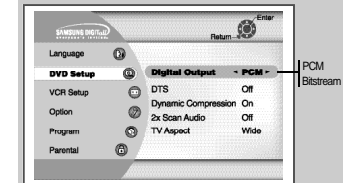

PCM
Bitstream

DTS

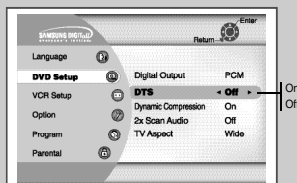

If your A/V receiver is equipped with a DTS decoder, your DVD-VCR can output DTS digital sound, but you **MUST** enable this feature in the menu system.

NOTE: Select "On" **ONLY** if you have connected a DTS-equipped A/V receiver to the DIGITAL AUDIO OUT (optical or coaxial) on the DVD-VCR back panel.

- 1 **Open "SETUP MENU"**
With the DVD in stop mode, press the SETUP button.
- 2 **Select "DVD Setup"**
Using the up and down buttons, move the selection cursor to "DVD Setup," then press ENTER to select.
- 3 **Set "DTS"**
Move the selection bar to "DTS," then press right or left to select from the following options:
 - Off - To use your DVD/TV with an A/V receiver NOT equipped with a DTS decoder.
 - On - To use your DVD/TV with an A/V receiver equipped with a DTS decoder.

Dynamic Compression

Dynamic Compression restrains the dynamic range of sound, i.e. the difference between the calm and noisy passage of a DVD audio track.

- 1 **Open "SETUP MENU"**
With the DVD in stop mode, press the SETUP button.
- 2 **Select "DVD Setup"**
Using the up/down and left/right buttons, move the selection cursor to "DVD Setup," then press ENTER to select.
- 3 **Set "Dynamic Compression"**
Move the selection bar to "Dynamic Compression," then press right or left to select from the following options:
 - On - The total dynamic range of the DVD soundtrack will be compressed, so quiet passages will be louder and loud passages will be softer.
 - Off - The original dynamic range will be preserved.

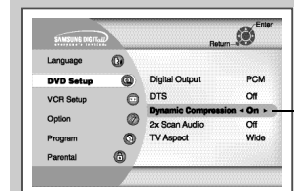

2X Scan Audio

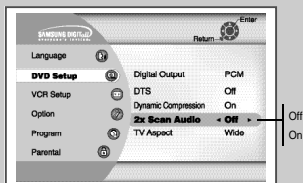

When you play DVD Disc at 2x play mode you can turn Audio on or off.

1 Open "SETUP MENU"

With the DVD in stop mode, press the SETUP button.

2 Select "DVD Setup"

Using the up and down buttons, move the selection cursor to "DVD Setup," then press ENTER to select.

3 Set "2x Scan Audio"

Move the selection bar to "2x Scan Audio," then press right or left button to select from the following options:

- Off - Turns 2x audio off.
Though 2x Scan Audio is ON in the SETUP MENU, no sound will be heard on discs which are recorded with LPCM, DTS or MPEG-2 Audio.
- On - Turns 2x audio on.

TV Aspect Ratio

Set the aspect ratio (length x width) of your TV screen so the DVD player will display movies at the appropriate size for your television. Choose from standard, letterbox, or widescreen format.

1 Open "SETUP MENU"

With the DVD in stop mode, press the SETUP button.

2 Select "DVD Setup"

Using the up and down buttons, move the selection cursor to "DVD Setup," then press ENTER to select.

3 Set "TV Aspect"

Move the selection bar to "TV Aspect", then press the left or right button to select from the following options:

- Letterbox – This method displays the full width of the widescreen movie on a standard 4:3 television. As a result, black bars will appear at the top and bottom of the screen.
- Pan-Scan – The familiar way of watching DVD and VHS movies, this method selectively crops (by panning and scanning) to keep the most important part of the picture (visible) wide screen movies to fit a standard 4:3 television screen.
- Widescreen – This method allows you to view the full 16:9 picture on a widescreen television.

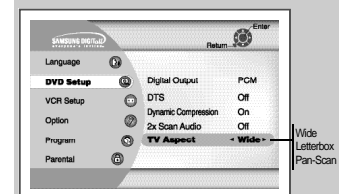

Wide
Letterbox
Pan-Scan

A/V Receiver Connections

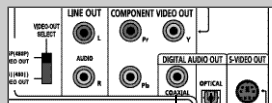

OR
To Digital Audio Input of an A/V Receiver with a Dolby Digital Decoder

To take full advantage of the movie theater experience that DVD offers, you may want to connect your DVD-VCR to a complete Surround Sound system, including an A/V Receiver and six Surround Sound speakers.

Before You Begin...

- If your A/V receiver is equipped with a Dolby Digital Decoder, you have the option to bypass the DVD-VCR's built-in Dolby Digital Decoder. Use the DIGITAL AUDIO OUT connection below.

1 Digital Audio Out

Connect EITHER an optical cable OR a digital coaxial cable from the DIGITAL AUDIO OUTjacks on the back panel of the DVD-VCR to their corresponding Digital Audio Input jacks on your A/V Receiver:

- Optical
- Coaxial
- Use whichever connection is available on your A/V Receiver.

Special Playback Features

During DVD/CD playback you can select from the following special playback options. To resume normal playback, press the ►|| (Play/Pause) button.

1 Pause

Press the ►|| (Play/Pause) button on the remote control during playback.

- The picture will pause and the audio will mute.
- To resume playback, press the ►|| (Play/Pause) button.
- If the player is left in Pause mode for 5 minutes, it will stop automatically.

2 Frame Advance (Step)

While in Still or Play mode, rotate JOG DIAL on the remote control to advance one frame at a time.

- Audio is muted during Frame Advance mode.
- Press ►|| (Play/Pause) to resume normal playback.

NOTE: Frame Advance operates only in the forward direction.

3 Skip Forward/Back

While a CD or DVD disc is in Play mode, press the Skip Forward/Back (►|/|◄◄) buttons on the remote control or front panel to jump forward and backward through disc chapters/tracks.

- Skip Forward will jump to the next chapter/track.
- Skip Back will jump to the beginning of the current chapter/track.
- Press Skip Back again to jump to the beginning of the previous chapter/track.

Search Forward/Back

While a disc is in Play mode, rotate shuttle ring on the remote control and, press the Forward/Back (►|/|◄◄) buttons on the remote control or front panel to visually search forward/backward at 2X - 4X - 8X - 16X - 32X - 128X speed. Press ►|| (Play/Pause) button to resume normal speed.

4 Slow Motion

During playback, press the ►|| (Play/Pause) button to Still the image. Press and hold Forward/Back buttons on the Remote control.

- Press and hold the Forward button (►|) on the remote and front panel to increase or decrease the speed from normal playback to 1/8, 1/4, or 1/2 speed.
 - Audio is muted during slow motion playback.
 - Shuttle ring on the remote control rotates the shuttle ring on the remote control to activate slow motion playback.
- Press the ►|| (Play/Pause) button to resume normal playback.

5 Stop/Resume

- Press the Stop button once to stop playback. To resume the DVD/CD from the point where the disc stopped, press the ►|| (Play/Pause) button.
- Press the ■ (Stop) button twice to completely stop playback. The next time you press ►|| (Play/Pause), the disc will start over from the beginning.

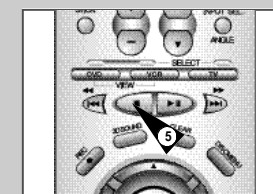
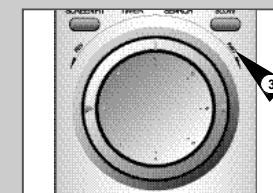
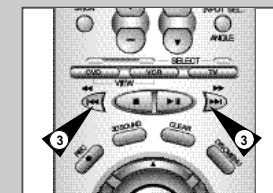
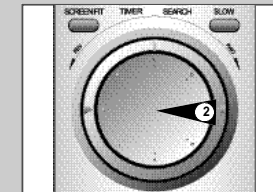
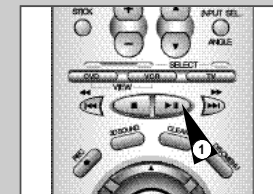

Disc Menu Navigation

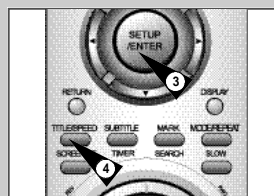
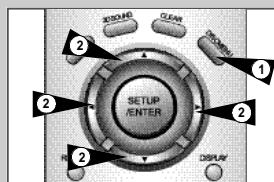

Many DVDs feature their own menu systems, where you can select Titles, Chapters, Audio Tracks, Subtitles, and special disc features, such as movie trailers, and information on the cast. Use these buttons to make selections in the Disc menus.

- 1 **DISC MENU** Button
Press to access the DVD's Disc menu, if applicable.
- 2 Press ▲, ▼ or ◀, ▶ to navigate through DVD's Disc menu options.
 - Press up, down, left and right to highlight menu choices.
- 3 **ENTER** Button
Press to make your selections in the Disc menu.
- 4 **TITLE** Button
Press to access the DVD's Title menu, if applicable.

Screen Fit Playback



- 1 **SCREEN FIT** Button
During play, press SCREEN FIT button on the remote control.
 - Allows you to eliminate the black bars in the top and bottom of the screen when a DVD movie is playing.
 - Screen Fit will work when the Zoom mode is active. (you can not remove the black bars on the screen) However, Zoom mode will work when Screen Fit is active.
-
- Various aspect ratios are available only in multiple screen format discs.
 - This function does not work when a DVD has been recorded in a multi-camera angle format.
 - On some DVDs, the black bars cannot be eliminated due to their aspect ratio.

Title/Chapter/Time Selection

If you press the DISPLAY button during DVD playback, you can view the current Title, Chapter/Track, and counter position. You can also use the Display screen as a fast way to choose a title, chapter/track, or playing time.

- 1 **View the Display**
Press the DISPLAY button on the remote control during DVD/CD playback.
- 2 **Select Title**
Press the up/down and left/right buttons to select Title, then press ENTER to change among all available titles on the disc.
 - The "TITLE" icon light will appear on the Front Panel Display.
- 3 **Select Chapter or Track**
Press the up/down and left/right buttons to select Chapter or Track, then press ENTER to change among all available Chapters/Tracks on the disc.
 - The "CHAP" icon light will appear on the Front Panel Display, followed by the current title number, hours, minutes, and seconds.
- 4 **Select Counter Position**
Press the up/down and left/right buttons to select the counter position indicator, then use the number buttons (0-9) to enter the desired counter position in the format HH:MM:SS (H = Hours, M = Minutes, S = Seconds). Then press ENTER to enter the desired counter position.

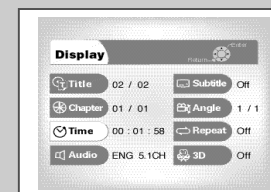
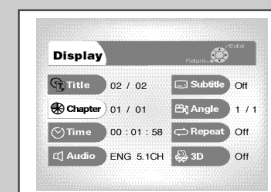

Zoom

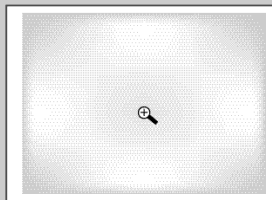

2 or 4 times magnification is available while you watch a DVD.

- 1 Open Zoom Magnifying Glass**
During Playback or STILL mode, press the ZOOM button to display the "Magnifying Glass icon" on the screen.
- 2 Position Magnifying Glass**
Use the ▲, ▼, ◀, ▶ buttons to move the magnifying glass to any position on the screen you want to zoom.
- 3 Zoom In**
Press the ENTER button repeatedly to zoom in at 2X - 4X - 2X - and normal magnification.

Angle View

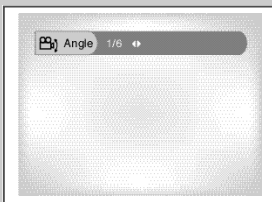
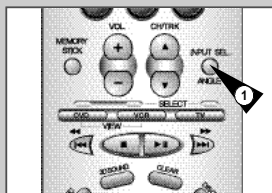

Some DVD Movies provide you with various camera angle views on the same scene while they are playing. To activate the feature press the Angle Button.

- 1 Check for Angle Icon**
Press the Angle button, you'll see the Angle Icon when watching a DVD with multi Angles available.
- 2 View Angle Menu Options**
When the Angle Icon comes up on the screen press the Angle button to see the Angle menu.
- 3 Select an Angle option**
Press the up/down buttons to select a camera angle you wish to see.

Subtitle

Many DVDs provide subtitles in one or more languages. The SUBTITLE button provides a shortcut to view and select these options.

- 1 Open Subtitle Menu**
During playback, press the SUBTITLE button.
- 2 Set Subtitle Language**
Press the left/right buttons to select among all available subtitle languages.
 - Subtitle languages are often represented by abbreviations.
- 3 Activate Subtitles**
Press the up/down buttons to turn subtitles On or Off.
 - The default subtitle setting is Off.

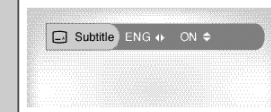
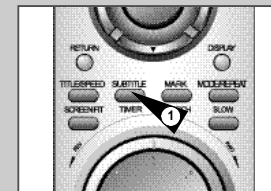

Audio

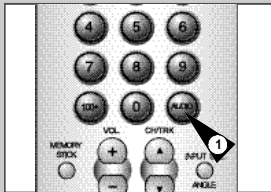

Many DVDs provide multiple language and audio setup options, such as Dolby Digital 5.1, Dolby Pro Logic, or LPCM 2 Channel audio. The AUDIO button provides a shortcut to view and select among all available options for a given disc.

1 Open the Audio Menu

During playback, press the AUDIO button on the remote control.

2 Select DVD Audio Track

Press the left/right buttons to select the desired language/audio setup on the DVD.

- Languages are represented by abbreviations; i.e. "ESP" for "español."



3D Sound

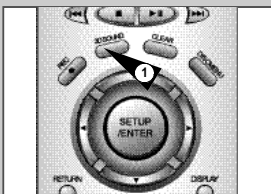

3D Audio is an enhanced audio mode that creates the illusion of Surround Sound with only two speakers.

1 Open 3D Sound Menu

During playback of a DVD, press the 3D SOUND button on the remote control.

2 Set 3D Sound

Press the up/down buttons to set "3D Sound" On or Off, then press the 3D SOUND button to confirm your selection.

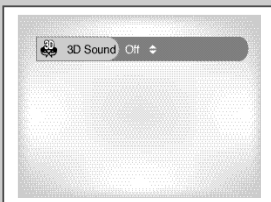

Repeat Chapter/Title

You can repeat a single chapter, or repeat a complete title.

1 Open Repeat Menu

In Play mode, press the REPEAT button to open the Repeat menu.

- The current Repeat Mode will be highlighted.

2 Select "Chapter"

Press the left/right buttons to select "Chapter".

- "Chapter" will highlight when Chapter Repeat is selected.

3 Repeat Chapter

Press the ENTER button to repeat the current chapter/track.

4 Select "Title"

Press the left/right buttons to select "Title".

- "Title" will highlight when Title Repeat is selected.

5 Repeat Title

Press the ENTER button to repeat the title.

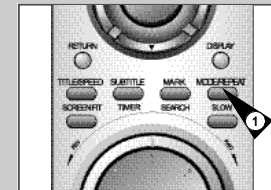

Bookmarks

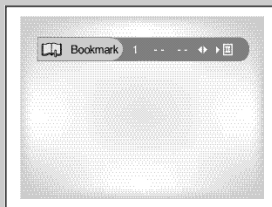
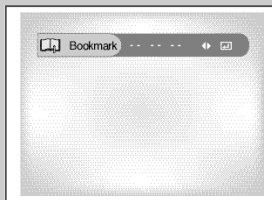

You can insert up to three Bookmarks on your DVDs, so you can jump quickly to your favorite scene or song.

1 Open Bookmark Menu

During playback, press the MARK button on the remote control. The "Mark" header will appear on the screen.

2 Select Bookmark Placeholder

Press the left/right buttons to move to one of the three bookmark placeholders (- - -).

- The selected placeholder will be highlighted.

3 Set the Bookmark

Play the DVD to the scene you want to bookmark, then press the ENTER button. The placeholder will change to a number (1, 2 or 3).

- You can continue setting up to three bookmarks.
- When finished, press the MARK button to exit.
- Depending on the disc, the bookmark function may not work.

4 Play Bookmark

- During playback, press the MARK button on the remote control.
- Press the left/right buttons to move to a previously set bookmark.
- Press the Play/Pause button to play the bookmark.
- Press the CLEAR button to cancel the bookmark.
- Press the MARK button again to exit the Bookmark menu.

Programmed Playback

Programmed Playback lets you set a custom order for playback of chapters/tracks on a DVD or CD.

1 Open Playback Mode Menu

While in Stop mode, press the MODE button.

2 Select "PROGRAM"

Using the left/right buttons, move the selection bar to "PROGRAM" then press ENTER to select.

3 Select Chapter/Track

Press the up/down and left/right buttons to select the first chapter/track in your revised playback list, then press the ENTER button.

4 Program Playback Order

Use the up/down and left/right buttons to select the remaining chapters/tracks, pressing Enter after each.

- Press the CLEAR button to change selections.

5 Play Revised Order

Press the ►|| (Play/Pause) button. The disc will play back in the custom programmed order.

- While in playback mode, press the CLEAR button on the remote control to cancel Programmed Play.

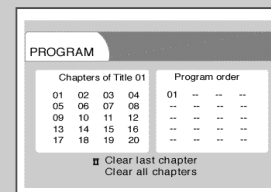
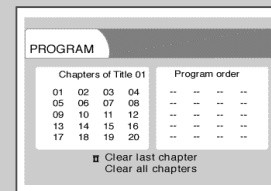

Random Playback

DVD Random Playback lets the DVD-VCR set a random order for playback of chapters/tracks on a DVD or CD.

1 Open Playback Mode Menu

In Stop mode, press the MODE button.

2 Select "RANDOM"

Using the left/right buttons, move the selection arrow to "Random On," then press ENTER to select.

- Press the "Play" button
The disc will playback automatically in random order.

3 Cancel Random Play

Press the CLEAR button on the remote control to cancel Random Play.

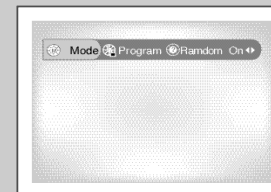

MP3 Playback



MP3 is a popular music format which allows you to compress music files up to 1/12 of their original size while retaining near CD quality sound. Your DVD-VCR can playback MP3 files burned onto a CD-R disc.

1 Insert Disc

Insert a CD-R with MP3 files into the DVD deck.

- The MP3 main menu will appear after a few seconds and the first song on the disc will begin playing.

2 Select Folder

Press the up/down buttons to select the folder which contains the MP3 files you want to hear, then press Enter to select.

- If there are more than 8 folders on the disc, press RETURN to view additional folders.
- If there are no folders on the CD-R, skip to Step 3.

3 Select MP3 File

Press the up/down buttons to select the desired MP3 file.

- If there are more than 10 MP3 files in the selected folder, press the left/right buttons to view additional MP3 files.
- Press the Return button to back up and select another folder.

4 Play MP3 File

Press the ENTER button on the remote control to play the selected song.

- While the song is playing, you can use the up/down buttons to browse through other folders.

5 Stop MP3 Selection

Press the ■ (Stop) button on the remote control to stop playback.

* To ensure proper playback of discs burned from MP3 files, make sure the files have been recorded at a bit rate of at least 128 kbps.

* If there are any gaps (blank data) on multi-session discs, you may experience playback problems.

* On discs that are recorded with a Variable Bit Rate(VBR), e.g. from 32 to 320 kbps, the sound may cut in and out.

Memory Stick

What is a Memory Stick?

"Memory Stick" is a new compact, portable and versatile IC (Integrated Circuit) recording medium with a data capacity that exceeds a floppy disk.

"Memory Stick" is specially designed for digital data exchange among "Memory Stick" compatible devices.

Because it is removable, the "Memory Stick" can also be used for external data storage.

There are two types of "Memory Sticks".

One is the regular "Memory Stick" and the other is the "MagicGate Memory Stick" equipped with "MagicGate" copyright protection technology.

"MagicGate" is a copyright protection technology that uses encryption.

1 MagicGate Memory Stick

Can be used for both copyright-protected and regular data.

2 Memory Stick

Can be used for regular data only.



- ◆ MagicGate Memory Sticks with copyright-protected data cannot be used in this unit.

Memory Stick

Precautions on handling the "Memory Stick"

- 1 Data can become corrupted in the following instances:
 - When the "Memory Stick" is taken out or the power is turned off while using the DPM (Digital Photo Manager) or DAM (Digital Audio Manager) function.
 - When using the "Memory Stick" in a location subject to static electricity or electric noise.
- 2 Memory sticks can only be read in this unit, not written.
- 3 Do not attach any other material than the supplied label on the label space.
- 4 Attach the label so that it does not stick out from the proper attachment location.
- 5 When moving or storing the "Memory Stick", use the storage case.
- 6 Do not touch the "Memory Stick" connector with your finger or metallic objects.
- 7 Do not bend, drop or apply strong shock to the "Memory Stick."
- 8 Do not disassemble or modify the "Memory Stick."
- 9 Do not allow the "Memory Stick" to get wet.

Memory Stick

Precautions on attaching/removing the "Memory Stick"

- 1 If it is not fully inserted, until you hear an audible "click", the "Memory Stick" will not work.
- 2 If you inadvertently remove the "Memory Stick" or turn off the power while using the DPM (Digital Photo Manager) or DAM (Digital Audio Manager) function, the recorded data may become corrupted.
- 3 To remove the "Memory Stick" during operation, see page 48 .

To format the "Memory Stick"

- 1 Do not format the "Memory Stick" using your computer. If you format the "Memory Stick" using the computer, you cannot use it with "Memory Stick" compatible devices.
- 2 If you need to format the "Memory Stick," use a "Memory Stick" compatible device (If formatted, all data previously recorded on the "Memory Stick" will be erased.)
- 3 If you use a "Memory Stick" that has been initialized using a computer or initialize a "Memory Stick" attached to a camera using USB connection, further operation is not guaranteed.
- 4 Be careful not to optimize the "Memory Stick" from a computer running a Windows operating system. The life of the "Memory Stick" will be shortened.
- 5 Do not compress the data recorded on the "Memory Stick." A compressed file cannot be played back on this unit.

Software Compatibility

- 1 Depending on the type of application software used, the file size of a still image may become larger when it is opened.
- 2 Depending on the type of application software used, only the first frame (thumbnail) of the clip motion file may be displayed.
- 3 An image file that has been modified using an image processing software may not open if it is converted into a different file format to play back with this product.

Memory Stick

Memory Stick functions applicable to DPM and DAM

Item	DPM (Digital Photo Manager)	DAM (Digital Audio Manager)
File Format	JPEG Image (*.jpg)	MP3 Music File (*.mp3)
File Size	<ol style="list-style-type: none"> All files in JPEG format that have less than 1600 x 1200 resolution can be played back with DPM. (JPEG files smaller than 1.5MB can be viewed with Photo View.) For JPEG data without thumbnail information, "Thumbnail not available" will be displayed in The Thumbnail View, however, they can still be played back in Photo View. 	- No limit to file size
Compatibility	<ol style="list-style-type: none"> Still image files with ".jpg" extension that have been recorded with a digital camcorder or digital still camera equipped with Memory Stick functions JPEG image files stored in Memory Stick using a Memory Stick adaptor for PC JPEG image files stored in CD-R/RW using CD Writer on PC, have to be stored using one of directory formats as follows (Capitalize all letters of directory name): <ol style="list-style-type: none"> 1) \DCIM\<dir>*.jpg 2) \PREVIEWS\<dir>*.jpg 3) \IMAGES\<dir>*.jpg 4) *.jpg <ul style="list-style-type: none"> The size of each <dir> cannot be over 50MB. [case 1), 2), 3)] When storing files in root directory [case 4)], the size of root directory also cannot be over 50MB. 	All files in MP3 format that have been downloaded from a PC or PDA to Memory Stick (*.mp3)
Main Functions	Directories Supported <ul style="list-style-type: none"> Memory Stick DPM -DCIM\<dir>*.jpg Picture CD DPM (Compatible with Picture CD of Kodak, Fuji, Qss (Noritus), and Konica) 	MP3 music files recorded on Memory Stick can be played back. However, although non-MP3 files are also displayed on DAM, they cannot be played back.

DAM (Digital Audio Manager) Playback

MP3 Playback

- Press Stop if in play mode.
- Press the M.STICK button on the remote and the screen to the right will appear.
- Insert the Memory Stick encoded with MP3 files into the Memory Stick Slot.
- Press the UP/DOWN buttons on the remote control to select Digital Audio Manager, and then press the ENTER button.
 - Your selection is highlighted with yellow borders.
- Use the UP/DOWN buttons to select the desired song.
- Press the ENTER button to start play.
 - Press the MENU button to return to the Start menu.
 - If the PLAY button is pressed during the playback of an MP3 file, the song will start from the beginning again.
 - If the SKIP button is pressed during the playback of an MP3 file, the next song will be played.

Screen Configuration

- FOLDER UP:** Use to move "up" a folder when you have multiple folders.
- PLAYLIST:** Shows the playlist.
- INFO:** Shows information about the Selected song being played.
- EXIT:** Takes you to the Start menu.
- Shows brief information about the selected song.
- The title of the song currently playing
- Shows a list of MP3 files and folders found in the memory stick.
- Shows the title and playback time of the currently playing song in the scroll box.
 - If the REPEAT button is pressed, the following displays will appear:
 - If the REPEAT button is pressed, all MP3 files in a given folder will be played back repeatedly in the order they are listed under that folder.
 - If the REPEAT button is pressed once again, the Shuffle function is activated. (All MP3 songs in a list are played once in random order.)
 - If the REPEAT button is pressed yet once again, the Continuous Shuffle function is activated. (All MP3 songs in a list are played in random order.)
 - If the REPEAT button is pressed still yet once again, the Repeat function is deactivated.

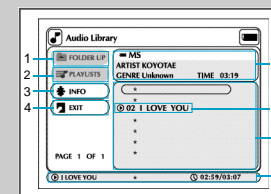
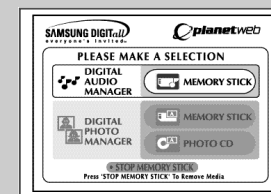

Memory Stick Pull out

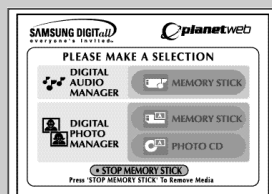
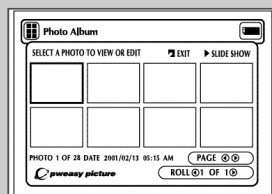

- 1 If using DPM (Digital Photo Manager) or DAM (Digital Audio Manager), move to Exit, and then press the ENTER button to exit to Disc Menu.
- 2 Move to the "STOP MEMORY STICK" function at the bottom of the menu and then press the ENTER button.
- 3 When the "PLEASE REMOVE MEMORY STICK" message appears on the top of the menu, remove the Memory Stick.
- 4 If the above sequence is not followed and the Memory Stick is inadvertently removed or the power is turned off, the data recorded on the Memory Stick may become corrupted.

DPM (Digital Photo Manager) Playback

View Photo Album (Memory Stick/Photo CD)

- 1 Press Stop if in play mode.
- 2 Press the M.STICK button on the remote and the screen to the right will appear.
- 3 Insert the Memory Stick/Photo CD containing JPEG files into the Memory Stick Slot.
- 4 Press the UP/DOWN buttons on the remote control to select DIGITAL PHOTO MANAGER, and then press the ENTER button.
 - Your selection is highlighted with yellow borders.
- 5 JPEG files in the Memory Stick/Photo CD will be displayed on the screen in the order of their recording.
- 6 Use the UP/DOWN/LEFT/RIGHT buttons to select the image you want, and then press the ENTER button to display it in full view on the TV screen, or use the UP/DOWN/LEFT/RIGHT buttons to select SLIDE SHOW press ENTER, and the slide show will begin. Slides will be displayed in order for a few seconds at a time.

- The Auto Power Off function does not work while any DPM function is active.

Screen Configuration

- 1 **EXIT:** Takes you to the Start menu.
- 2 **SLIDE SHOW :** Begins the slide show.
- 3 **PAGE :** Highlight the PAGE menu item and use LEFT/RIGHT buttons to move to the next page of thumbnails.
- 4 **ROLL:** Allows navigation when there are multiple directories below '/DCIM' of Memory Stick. (See page 46)
- 5 Photo Information.

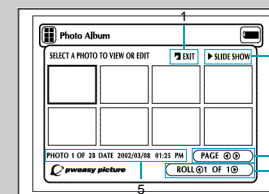
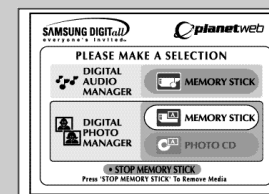

Slide Show

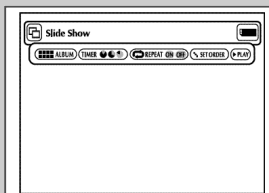

- 1 Use the LEFT/RIGHT buttons on the remote control to select Slide Show.
 - Your selection is highlighted with yellow borders.
- 2 Press the ENTER button and the Slide Show will begin.
 - To execute any function or option, be sure to press the ENTER button after selecting the menu item you want.
 - If there is no input for 5 seconds, the Slide Show menu will disappear, and the slide show will begin.
 - To view the Slide Show menu, press the UP/DOWN/LEFT/RIGHT button on the remote control. The slide show will stop and the menu will be displayed.
 - Select the PLAY menu item to resume.

Menu Description

- **ALBUM** : Takes you back to the Photo Album.
- **TIMER**: Indicates the delay between images in a slide show.
- **REPEAT** : If ON is selected, the slide show will repeat indefinitely.
- **SET ORDER**: Use to change the order of images in a slide show.
- **PLAY**: Begins the slide show.

Slide Show Order

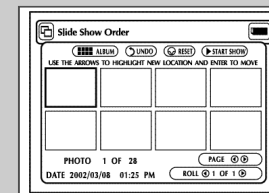

- 1 Use the LEFT/RIGHT buttons to select Slide Show and press ENTER.
 - Your selection is highlighted with yellow borders.
- 2 Use the LEFT/RIGHT buttons to select Set Order and press ENTER.
- 3 Use the UP/DOWN/LEFT/RIGHT buttons on the remote control to select the image you want to move, and then press the ENTER button.
 - Your selection is highlighted with yellow borders.
- 4 Use the UP/DOWN/LEFT/RIGHT buttons on the remote control to select the location you want to move the image to, and then press the ENTER button.
 - Source location is indicated with yellow borders.
 - Destination location is indicated with green borders.
- 5 After moving the images to another location, you can begin the slide show by choosing START SHOW.
 - For those images you don't want to include in the slide show, select the image from the Slide Show Order screen, and then press the CLEAR button.

- ◆ Slide Show order will reset when you turn player off.

Menu Description

- **ALBUM**: Takes you to Photo Album.
- **UNDO**: Restores the image you moved most recently to its original location.
- **RESET**: Restores all the images to their original locations.
- **START SHOW**: Begins the slide show.

Photo View

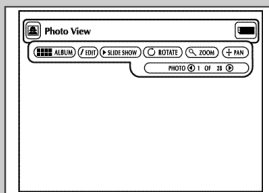

- 1 Use the UP/DOWN/LEFT/RIGHT buttons on the remote control to select the desired image from the Photo Album screen, and then press the ENTER button.
 - The selected image will appear on the TV screen.
- 2 Use the UP/DOWN/LEFT/RIGHT buttons on the remote control to move to the menu item you want, and then press the ENTER button.
 - If there is no input for 5 seconds, the Photo View menu will disappear. To view the menu again, press the UP/DOWN/LEFT/RIGHT button.

Menu Description

- **ALBUM:** Takes you to Photo Album.
- **EDIT:** You can apply various effects to the selected image. This is only for viewing, the edited image cannot be saved.
- **SLIDE SHOW:** Begins the slide show.
- **ROTATE:** Each time the ENTER button is pressed, the image will rotate clockwise 90 degrees.
- **ZOOM:** Each time the ENTER button is pressed, the image will enlarge up to 6X Normal --> 2X --> 4X --> 6X --> Normal
- **PAN:** Press the ENTER button followed by the UP/ DOWN/ LEFT or RIGHT button to move the image in the direction of the arrow.
- **PHOTO 1 OF 11:** When the Photo menu item is highlighted, the LEFT/RIGHT button move to the next previous images.

Edit Photo

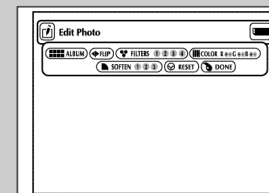

- 1 From the Photo View screen, use the UP/DOWN/LEFT/RIGHT buttons to select EDIT, and then press the ENTER button.
 - The Edit Photo menu appears.
- 2 Use the UP/DOWN/LEFT/RIGHT buttons on the remote control to move to the menu item you want, and then press the ENTER button.
 - If there is no input for 5 seconds, the Edit Photo menu will disappear. To view the menu again, press the UP/DOWN/LEFT/RIGHT button.

Menu Description

- **ALBUM :** Takes you back to the Photo Album.
- **FLIP:** Shows the mirror image.
- **FILTERS 1234:** You can apply various effects to the selected image.
 1. Black and white filter.
 2. Sepia (brown) filter.
 3. Image negative filter.
 4. Color negative filter.

- To restore the image to its original state, select RESET from the menu, and then press the ENTER button.
- **COLOR R +- G +- B +-:** Adjust Red, Green and Blue color balances each time ENTER is pressed.
- **SOFTEN 123:** Highlight 1 of 3 desired effects: 1) softens edges, 2) blurs the image and 3) creates an impressionist painting effect.
- **RESET:** Restores the image to its original state before the change was made.
- **DONE:** Returns you to the Photo View screen.

Special VCR Playback Features

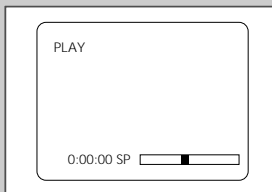

Press the DISPLAY button to see the current status of the VCR deck, as well as the tape counter position and record speed.

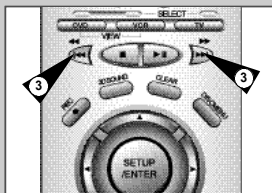

While a videotape is playing, you can enjoy a variety of special playback features, including Still, Frame Advance, Skip, Repeat, and more. Press the Play button again to resume normal playback.

- 1 Still**
From Play mode, press Play/Pause to still a single frame.
- 2 Frame Advance**
From still mode, press JOG DIAL to advance to the next frame.
- 3 Cue/Review**
From Play mode, press F.Forward (▶▶) or Rewind (◀◀) to cue/review at two speeds:
 - Picture Search — Press and release to advance the tape forward or backward at 5 times normal speed.
 - Jet Search — Press and hold to advance the tape forward or backward at 7 times normal speed.
- 4 Repeat**
From Play mode, press Repeat to review the last 5 seconds of tape (SP mode).
- 5 Shuttle**
From Play mode, Shuttle >> gradually increases the cue speed from Double-Speed playback to Picture Search to Jet Search. Shuttle << gradually slows down the tape, then goes into Slow mode, Still mode, Reverse Picture Search and Reverse Jet Search.

Tracking

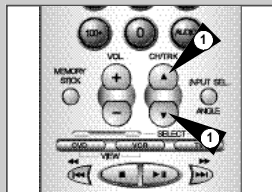

The Tracking adjustment removes the white lines that sometimes appear during playback because of slight differences in recording decks. The TRK button will automatically align the recorded tracks with the playback heads to solve this problem. You may also set tracking manually.

- 1 Adjust Tracking Manually**
During playback, press the TRK ▲ or TRK ▼ buttons to remove the white lines from the picture.

Auto Play

If you want your videotapes to play automatically when you insert them, turn on Auto Play.

NOTE: Only tapes that are missing the Record Safety Tab will play automatically when inserted.

- 1 Open the "SETUP MENU"**
With the DVD in stop mode, press the SETUP button.
- 2 Select "VCR Setup"**
Using the up/down and left/right buttons, move the selection arrow to "VCR Setup," then press ENTER to select.
- 3 Select "Auto Play"**
Move the selection arrow to "Auto Play," then press right to select from the following options:
 - On - The VCR will automatically begin playing a video tape when it is inserted, as long as the safety tab of the cassette has been removed.
 - Off - Auto play is disabled.
- 4 Tape Length**
Press the left button to select the video cassette length. This information is usually printed on the tape box. The menu cycles through: T120, T160 or T180. Once the type of cassette is set, the VCR can display the amount of time remaining on the tape when you press the DISPLAY button.
- 5 Auto Repeat**
In the VCR Setup "Auto Repeat" sets the VCR to play a tape repeatedly [unless a tape control is activated (stop, fast forward or rewind)].

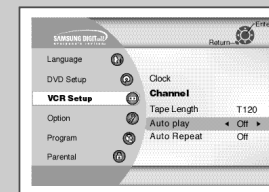
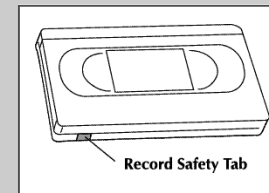

S-VHS Playback

The DVD-VCR allows you to playback high quality S-VHS tapes.

- 1 Insert a S-VHS Tape**
Insert an S-VHS tape into the VCR deck.
- 2 Start Playback**
Press Play/Pause on the remote control to begin playback of the S-VHS tape.

Variable Search System

Scan and play:
press [◀] or [▶]
Go to [0:00:00]:
Press [▲]
End search:
Press [▼]

0:00:00 SP 

Press the **SEARCH** button to display the search screen in the stop mode. When a program is recorded, the starting point is given an Index mark for easy location. However, the VHS Index Search System (VISS) cannot recognize index marks made by old VCRs. If the VCR has trouble finding a mark, it is probably because the cassette was recorded on a VCR without VISS. If you want to index two programs in a row, set your VCR to stop, then start recording each program. Pause has no effect on index marks.

1 Scan and play

Use scan and play when you don't know exactly where a program is located on a cassette tape.

- Press right arrow for forward scan or left arrow for reverse scan.
- The display will show "Scan and Play".
- When an index mark is found, the VCR plays for about five seconds.
- Press the **PLAY** button to view that program.

If you don't press **PLAY**, the VCR automatically searches for the next index, or until the end of the tape is reached.

2 Go to 0:00:00 stop

Use this feature when you want to search for the 0:00:00 counter position on a cassette. Press the **CLEAR** button at the point on the tape where you want to set the counter to 0:00:00. Later, while a cassette is stopped, press the up arrow button. The VCR will rewind or fast forward, searching for the 0:00:00 counter position, and then automatically stop at that position.

3 End search

Use this feature when you want to search for a blank position to record a program on a cassette. While a cassette is stopped, press down arrow button. The VCR will fast forward, searching for a blank position, and then automatically stop at that position. If the VCR reaches the end of the tape during end search, the tape will be ejected.

Basic Recording

You can record a TV show in progress by inserting a blank tape and pressing the **REC** button. You can even add time in 30-minute increments up to 4 hours by pressing the **REC** button repeatedly; see page 49.

NOTE: Be sure your videotape has a Record Safety Tab. If the tab is missing, you can cover the opening with a small piece of tape. **Warning:** Do not cover this opening unless you are sure you want to record over the tape.

Before You Begin...

- **Power on the DVD-VCR**
- **Power on the TV**
- **Set the TV to channel 3 or 4 .**

1 Insert Tape

Insert a blank VHS tape into the VCR deck.

- Make sure the tape is long enough to record the entire program. To change the Recording Speed, see page 49.

2 Select a Channel to Record

Use the 0-9 buttons or the Channel Up/Down arrow buttons to select the desired channel, or press the **INPUT SEL.** button to select Line 1 or 2 if recording from an external device connected to the front or rear Line inputs, respectively.

3 Start Recording

Press the **REC** button on the remote control or front panel. For options while recording is in progress, see "Special Recording Features" on the next page.

- Recording from the DVD player to the VCR is not possible.

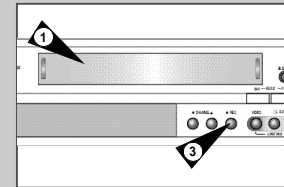
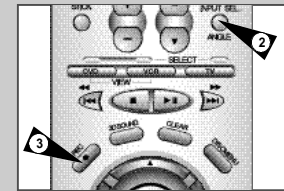
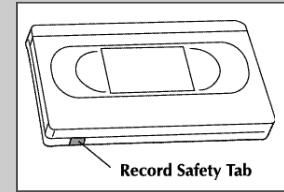

Special Recording Features

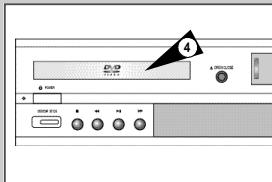
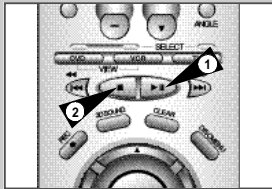

While a recording is in progress, you can watch a different channel, watch a DVD, or add recording time in 30-minute increments.

1 Pause/Resume Recording

Press the ►|| (Play/Pause) button. Press REC again to resume.

2 Stop Recording

Press the STOP button.

3 Watch a Different Channel

Press the TV/VCR button on the remote to switch to your TV tuner, then select a different channel on your television.

4 To Watch a DVD

Insert a DVD in the DVD deck and press Play. The output will automatically change to the DVD.

5 Add Recording Time

See One-Touch Recording (OTR) on the next page.

One-Touch Recording (OTR)

One-Touch Recording (OTR) allows you to add recording time in 30-minute increments up to 4 hours at the touch of a button.

1 Start Recording

Follow the instructions on page 57 to begin recording.

2 Activate OTR

While in Record mode, press the REC button again to activate One-Touch Recording (OTR).

- Record length 0:30 appears on the On-Screen Display and the DVD-VCR will record for exactly 30 minutes.

3 Add Recording Time

Continue pressing REC to add recording time in 30 minute increments up to 4 hours.

- The DVD-VCR stops recording automatically when the time has elapsed.

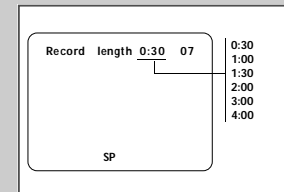

Record Speed

You can slow down the recording speed from SP to SLP in order to fit six hours of programming on a T-120 tape.

1 Start Recording

Follow the Basic Recording instructions on page 57.

2 Set Record Speed

Press the SPEED button on the remote control to set the Record Speed to one of the following options:

- SP – Standard Play, for best quality.
- SLP – Super Long Play, for maximum recording time (3 times SP).

NOTE: The selected Record Speed will appear on the front panel display and on-screen display.

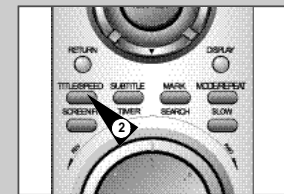

Maximum Recording Time - SP vs. SLP

Tape Length	SP (Standard Play)	SLP (Super Long Play)
T-120	2 hrs	6 hrs
T-160	2hrs 40 mins	8 hrs
T-180	3 hrs	9 hrs

Stereo Connections

You can enjoy stereo sound when watching movies and TV shows by connecting your DVD-VCR to your home stereo system or stereo TV.

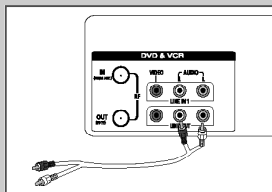

1 Connect DVD-VCR to Stereo

Connect RCA cables from the Line Out Left & Right Audio jacks on the back panel of the DVD-VCR to the Auxiliary Inputs on your stereo receiver. If you are using a stereo television, connect the Video Output as well.

2 Set Stereo to Auxiliary Mode

Set your stereo receiver or television to "Aux" or "Tape," whichever selects the line input for your particular device.

3 Play a Tape

Insert a DVD or Hi-Fi stereo videotape in your system and adjust the volume on your stereo receiver or television. You should hear the audio through your stereo speakers.

- If you still do not hear stereo sound after inserting Hi-Fi stereo video tape, press the Audio button until "Hi-Fi" appears on the on-screen display.

Monitor TV Connections

Monitor-style televisions offer improved sound and picture over regular televisions because they receive the audio and video signals directly from the DVD-VCR through the line inputs.

NOTE: A monitor television is not the same as a computer monitor.

1 Connect VCR to Monitor TV

Connect RCA cables from the Audio/Video Line Out jacks on the back panel of the DVD-VCR to the Audio/Video Line Inputs of your monitor TV.

2 Set TV to Auxiliary Mode

Set your monitor TV to "Aux," "Video," or "Line." Refer to your monitor television owner's manual for the correct setting.

3 Connection is Complete

NOTE: With this connection, the TV/VCR button has no effect. It is as if the TV/VCR button were always set to VCR.

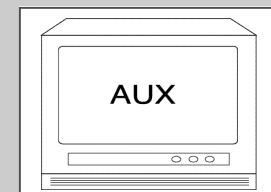
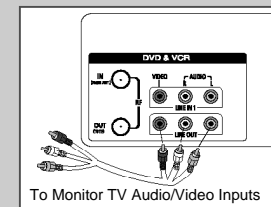

Connecting Other Video Equipment

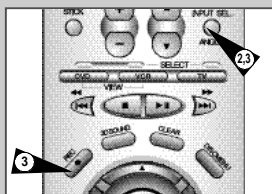
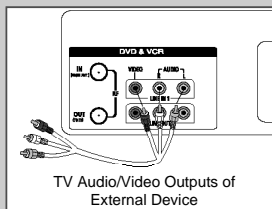

You can connect a wide variety of audio/video equipment to your DVD-VCR, including:

- An additional VCR
- Laser Disc Player
- DVD Player
- Camcorder
- Satellite Receiver
- Video Game

Since all of these devices use essentially the same connections, they will be described together.

1 Connect Device to DVD-VCR

Connect RCA cables from the Audio and Video Line Outputs of your external device to the Audio and Video Line Inputs on the front or back panel of the DVD-VCR.

2 Watch Device

Play your external device, then press the Input Sel. button until the playback from LINE1 (rear panel inputs) or LINE2 (front panel inputs) appears on your TV screen.

3 Record Device

First, play your external device. Next, press the Input Sel. button until the playback from LINE1 (rear panel inputs) or LINE2 (front panel inputs) appears on your TV screen. Then press Record on the VCR deck.

4 Timer Record From Device

Select LINE1 (L1) or LINE2 (L2) as your record source in the Timer Record menu. All other Timer Record settings should be set in the usual manner.

Technical Specifications

Inputs	AUDIO	2 Stereo audio inputs, RCA Connector, -8dbm, 47K , front and rear
	VIDEO	2 Composite video inputs, RCA Connector, 75 , 1Vp-p
	RF	Antenna or CATV Input, F-Connector, 75
Outputs	AUDIO	1 Stereo audio outputs, RCA Connector, -8dbm, 1.5K
	AUDIO (DVD only)	2 Digital audio outputs (1 optical, 1 coaxial) 1 Stereo audio outputs
	VIDEO	1 Composite video output, RCA Connector, 75 , 1Vp-p
	VIDEO (DVD only)	1 S-Video output, S-Connector, 75 , Y=1.0Vp-p, C=0.286Vp-p 1 Component video output, 75 , Y=1.0Vp-p, Pb=0.7Vp-p, Pr=0.7Vp-p
VCR	RF	Channel 3 or 4
	VIDEO SYSTEM	1/2-inch VHS system, 4 rotary head helical scanning; FM azimuth luminance;chrominance: converted sub system phase shift
	AUDIO TRACK	Normal: 1 track; Hi-Fi: 2 track
	PLAY/RECORD TIME	T-180 tape: SP 3 hours, SLP 9 hours
	FF/REW TIME	T-120 tape: <2 minutes
	HEADS	Video: DA 4 rotary
		Audio: 2 rotary heads (Hi-Fi); 1 stationary head (Linear)
		Control:1 stationary head
		Erase: 1 full track, 1 audio track
	WOW & FLUTTER	Less than 0.005% (Hi-Fi)
FREQ. RESPONSE	20-20,000 Hz (Hi-Fi)	
DVD	DISC COMPATIBILITY	CD, CD-R, CD-R/W DVD-Video, CD-Digital Audio (5" and 3.5"), CD-Video, MP3 files on CD-ROM
	FREQ. RESPONSE	96/48 kHz Sampling: 4 Hz-22kHz
	S/N RATIO	110 dB
	DYNAMIC RANGE	96 dB
	THD	0.003 %
SYSTEM	POWER REQUIREMENT	120V AC, 60 Hz, 25 watts
	ENVIRONMENT	41-104 F (5-40 C); 10%-75% humidity
	WEIGHT	13.8 lbs.



Samsung Limited Warranty

Samsung Electronics Canada Inc. (SECA), warrants that this product is free from defective material and workmanship.

SECA further warrants that if this product fails to operate properly within the specified warranty period and the failure is due to improper workmanship or defective material SECA will repair or replace the product at its option.

All warranty repairs must be performed by a SECA authorized service centre. (The name and address of the location nearest you can be obtained by calling toll free **1-800-268-1620** or visiting our web site at **www.samsung.ca**)

Labour
one (1) year (carry-in)

Parts
one (1) year

On carry-in models, transportation to and from the service centre is the customer's responsibility.

The original dated sales receipt must be retained by the customer and is the only acceptable proof of purchase. It must be presented to the authorized service centre at the time service is requested.

Exclusions

This warranty does not cover damage due to accident, fire flood and/or other acts of God; misuse, incorrect line voltage, improper installation, improper or unauthorized repairs, commercial use, or damage that occurs in shipping. Exterior and interior finish, lamps and glass are not covered under this warranty. Customer adjustments which are explained in the instruction manual are not covered under the terms of this warranty. This warranty will automatically be voided for any unit found with a missing or altered serial number. This warranty is valid only on products purchased and used in Canada.

SAMSUNG ELECTRONICS CANADA, INC.

HEADQUARTERS

SAMSUNG ELECTRONICS CANADA, INC.
7037 FINANCIAL DRIVE MISSISSAUGA, ONTARIO L5N 6R3 CANADA
MADE IN KOREA
TEL: 1-905-542-3535
www.samsung.ca

CUSTOMER SERVICE

7037 Financial Drive Mississauga, Ontario L5N 6R3 Canada
1-800-SAMSUNG (1-800-726-7864)

