



# DVD Player

## DVD-HD746



## Precautions

### 1. Setting up

- \* Refer to the identification label located on the back panel of your player for its proper operating voltage.
- \* Install your player in a cabinet with adequate ventilation holes. (7~10cm) Do not block ventilation holes on any of the components for circulation of air.
- \* Do not push the disc tray by the hand.
- \* Do not stack components.
- \* Be sure to turn all components off before moving the player.
- \* Before connecting other components to this player, be sure to turn them off.
- \* Be sure to remove the disc and turn off the player after use, especially if you don't use it for a long time.

### 2. For your safety

- \* This product utilizes a laser. Use of controls or adjustments or performance of procedures other than those specified herein may result in hazardous radiation exposure.
- \* Do not open covers and do not repair yourself. Refer servicing to qualified personal.

### 3. Caution

- \* Your player is not intended for industrial use but for domestic purposes. Use of this product is for personal use only.
- \* Do not put any container filled with liquid or any small metal objects on the player.
- \* Exterior influences such as lightning and static electricity can affect normal operation of this player. If this occurs, turn the player off and on again with the POWER button, or disconnect and then reconnect the AC power cord to the AC power outlet. The player will operate normally.
- \* When condensation forms inside the player due to sharp changes in temperature, the player may not operate correctly. If this occurs, leave the player at room temperature until the inside of the player becomes dry and operational.

### 4. Disc

- \* Do not clean record-cleaning sprays, benzene, thinner, or other volatile solvents that may cause damage to the disc surface.
- \* Do not touch the disc's signal surface. Hold by the edges or by one edge and the hole in the center.
- \* Wipe the dirt away gently; never wipe a cloth back and forth over the disc.

### 5. Environmental info

- \* The battery used in this product contains chemicals that are harmful to the environment.
- \* So, dispose of batteries in the proper manner, according to federal, state, and local regulations.

CAUTION : USE OF ANY CONTROLS, ADJUSTMENTS, OR PROCEDURES OTHER THAN SPECIFIED HEREIN MAY RESULT IN HAZARDOUS RADIATION EXPOSURE.

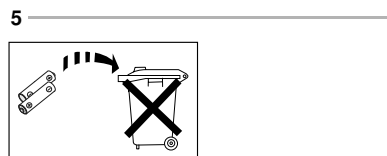
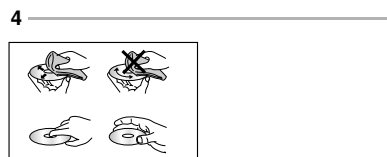
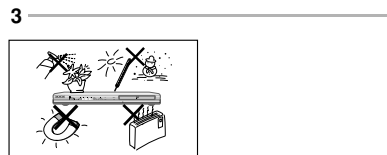
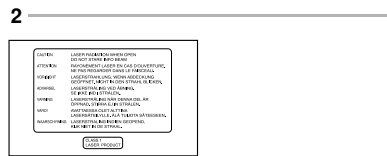
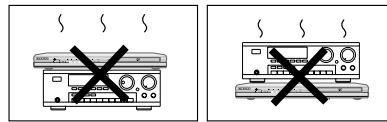
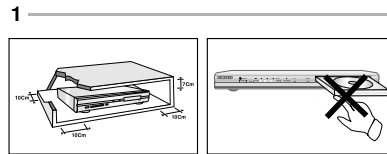

## Before you start

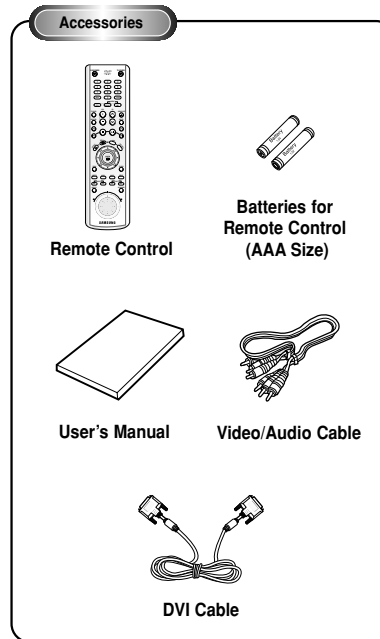

### Install Batteries in the Remote

1. Open the battery cover on the back of the remote.
2. Insert two AAA batteries. Make sure that the polarities (+ and -) are aligned correctly.
3. Replace the battery cover.

### If remote doesn't operate properly

- Check the polarity + - of the batteries (Dry-Cell)
- Check if the batteries are drained.
- Check if remote sensor is blocked by obstacles.
- Check if there is any fluorescent lighting nearby.

## Table of Contents

### Setup

Precautions	2
Before you start	3
General Features	4
Disc Type and Characteristics	5
Description-Front Panel	6
Description-Rear Panel	7
Tour of the Remote Control	8

### Connections

Choosing a Connection	9
-----------------------	---

### Basic Functions

Playing a Disc	13
Using the Search & Skip Functions	14
Using the Display Function	14
Using the Disc and Title Menu	15
Using the Function Menu	16
Repeat Play	16
Slow Repeat Play	17
Program Play & Random Play	17

### Advanced Functions

Adjusting the Aspect Ratio (EZ View)	18
Selecting the Audio Language	19
Selecting the Subtitle Language	19
Changing the Camera Angle	20
Using the Instant Replay/Skip Function	20
Using the Bookmark Function	21
Using the Zoom Function	22
SACD Playback	22
DVD AUDIO Playback	24
Clips Menu for MP3/WMA/JPEG/MPEG4	25
Folder Selection	26
MP3/WMA Playback	26
MPEG4 Playback	27
Picture CD Playback	29

### Changing Setup menu

Using the Setup Menu	30
Setting Up the Language Features	30
Setting Up the Audio Options	32
Surround Sound Speaker Setup	33
Setting Up the Display Options	34
Setting Up the Parental Control	36

### Reference

Controlling a TV with the Remote	38
Firmware upgrade	39
Troubleshooting	40
Specifications	42

## General Features

### Excellent Sound

Dolby Digital, a technology developed by Dolby Laboratories, provides crystal clear sound reproduction.

### Screen

Video with MPEG-2 compression technology. Both regular and widescreen(16:9) pictures can be viewed.

### Slow Motion

An important scene can be viewed in slow motion.

### Programmed Play (CD)

You can program tracks to play in desired order.

### Parental Control (DVD)

The parental control allows users to set the level necessary to prohibit children from viewing harmful movies such as those with violence, adult subject matter, etc.

### Various On-Screen Menu Functions

You can select various languages (Audio/Subtitle) and screen angles while enjoying movies.

### EZ VIEW (DVD)

Easy View can convert Letter Box images to full screen viewing on your conventional TV.

### Digital Photo Viewer (JPEG)

You can view Digital Photos on your TV.

### Repeat

You can repeat a song or movie simply by pressing the REPEAT button.

### MP3/WMA

This unit can play discs created from MP3/WMA files.

### Instant Replay (DVD)

This function is used to replay the previous 10 seconds of a movie from the current position.

### Instant Skip (DVD)

This function skips playback ahead 10 seconds.

### SACD (Super Audio CD)

SACD is a high quality audio format with higher sampling rates and fuller, richer sound as compared to regular CD.

### MPEG4

This unit can play MPEG4 formats within an avi file.

### DVD AUDIO

DVD AUDIO is a format specifically designed to provide the highest possible audio fidelity capable on DVD.

### DVI (Digital Visual Interface)

DVI reduces picture noise by allowing a pure digital video signal path from the player to your TV.

### Note

\* Discs which cannot be played with this player.

- DVD-ROM
- DVD-RAM
- CD-ROM
- CDV
- CDI
- CVD
- CDGs play audio only, not graphics.

\* Ability to play back may depend on recording conditions.

- DVD-R, +R
- CD-RW
- DVD+RW, -RW

\* The unit may not play certain CD-R, CD-RW and DVD-R due to the disc type or recording conditions.





### COPY PROTECTION

Many DVD discs are encoded with copy protection. Because of this, you should only connect your DVD player directly to your TV, not to a VCR. Connecting to a VCR results in a distorted picture from copy-protected DVD discs.









This product incorporates copyright protection technology that is protected by methods claims of certain U.S. patents and other intellectual property rights owned by Macrovision Corporation and other rights owners. Use of this copyright protection technology must be authorized by Macrovision Corporation, and is intended for home and other limited viewing uses only unless otherwise authorized by Macrovision Corporation. Reverse engineering or disassembly is prohibited.

## Disc Type and Characteristics

This DVD player is capable of playing the following types of discs with the corresponding logos:

Disc Types (Logos)	Recording Types	Disc Size	Max. Playing Time	Characteristics
	Audio + Video	12 Cm	Single-sided 240 min. Double-sided 480 min.	<ul style="list-style-type: none"> <li>• DVD contains excellent sound and video due to Dolby Digital and MPEG-2 system.</li> <li>• Various screen and audio functions can be easily selected through the on-screen menu.</li> </ul>
		8 Cm	Single-sided 80 min. Double-sided 160 min.	
	Audio + Video	12 Cm	74 min.	<ul style="list-style-type: none"> <li>• Video with CD sound, VHS quality &amp; MPEG-1 compression technology.</li> </ul>
		8 Cm	20 min.	
	Audio	12 Cm	74 min.	<ul style="list-style-type: none"> <li>• CD is recorded as a Digital Signal with better audio quality, less distortion and less deterioration of audio quality over time.</li> </ul>
		8 Cm	20 min.	
	Audio + Video	12 Cm	400 min.	<ul style="list-style-type: none"> <li>• DVD AUDIO is a format specifically designed to provide the highest possible audio fidelity capable on DVD.</li> </ul>
	Audio	12 Cm	74 min.	<ul style="list-style-type: none"> <li>• SACD is a high quality audio format with higher sampling rates and fuller, richer sound as compared to regular CD.</li> </ul>

### Disc Markings

	Play Region Number
	PAL broadcast system in U.K, France, Germany, etc.
	Dolby Digital disc
	Stereo disc
	Digital Audio disc
	DTS disc
	MP3 disc
	SACD disc
	DVD AUDIO disc

### Play Region Number

Both the DVD player and the discs are coded by region. These regional codes must match in order for the disc to play. If the codes do not match, the disc will not play.

**The Region Number for this player is described on the rear panel of the player.**

### DivX Certification

DivX, DivX Certified, and associated logos are trademarks of DivXNetworks, Inc and are used under license.



## Description-Front Panel

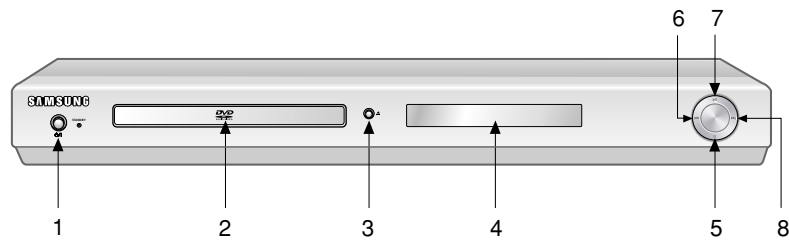

### Front Panel Controls

- 1. STANDBY/ON ( ⏻ )**
  - When the unit is first plugged in, the red indicator lights. When STANDBY/ON button is pressed on, the blue light appears and the player is turned on.
- 2. DISC TRAY**
  - Place the disc here.
- 3. OPEN/CLOSE ( ▲ )**
  - Press to open and close the disc tray.
- 4. DISPLAY**
  - Operation indicators are displayed here.
- 5. STOP ( ■ )**
  - Stops disc play.
- 6. SKIP ( ⏮ ) / SEARCH**
  - Use to reverse skip a scene or music.
- 7. PLAY/PAUSE ( ▶⏪ )**
  - Begin or pause disc play.
- 8. SKIP ( ▶▶ ) / SEARCH**
  - Use to forward skip a scene or music.

## Display Indicators

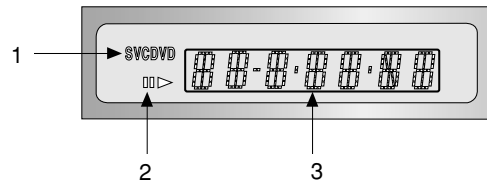

### Front Panel Display

1. Disc type indicators
2. Play / Pause / Forward play
3. Displays various messages concerning operations such as PLAY, STOP, LOAD ...
  - no DISC** : No disc loaded.
  - OPEN** : The disc tray is open.
  - LOAD** : Player is loading disc information.

## Description-Rear Panel

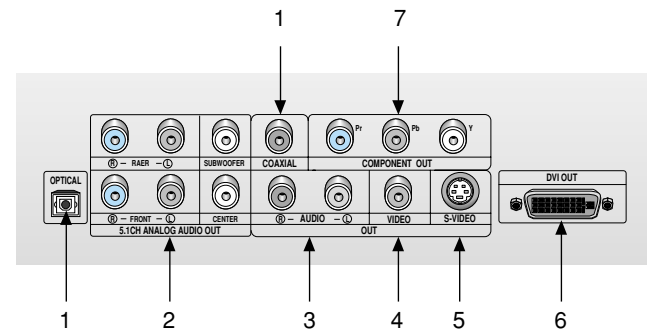

### Rear Panel

- 1. DIGITAL AUDIO OUT JACKS**
  - Use an optical or coaxial digital cable to connect to a compatible Dolby Digital receiver.
  - Use to connect to an A/V Amplifier that contains a Dolby Digital, MPEG-2 or DTS decoder.
- 2. 5.1CH ANALOG AUDIO OUT JACKS**
  - Connect to an amplifier with 5.1ch analog input jacks.
- 3. AUDIO OUT JACKS**
  - Connect to the Audio input jacks of your television, audio/video receiver.
- 4. VIDEO OUT JACK**
  - Use a video cable to connect to the Video input jack on your television.
  - The Video Output in Setup Menu must be set to Component (I-SCAN) or S-Video.
- 5. S-VIDEO OUT JACK**
  - Use the S-Video cable to connect this jack to the S-Video jack on your television for a higher quality picture.
  - The Video Output in Setup Menu must be set to S-Video.
- 6. DVI OUT JACK**
  - Use the DVI cable to connect this jack to the DVI jack on your television for the best quality picture.
  - The Video Output in Setup Menu must be set to Component (P-SCAN) & DVI.

### 7. COMPONENT OUT JACKS

- Use these jacks if you have a TV with Component Video in jacks. These jacks provide Pr, Pb and Y video.
- If Component (P-SCAN)&DVI Video Output is selected in Setup Menu, interlaced scan mode and Video, S-Video will not work.
- If Component (I-SCAN) Video Output is selected in Setup Menu, progressive scan and DVI mode will not work.

### Important Note

- Consult your TV User's Manual to find out if your TV supports Progressive Scan. If Progressive Scan is supported, follow the TV User's Manual's instructions regarding Progressive Scan settings in the TV's menu system.
- If Component(P-SCAN) & DVI Video Output is selected in Setup Menu, Video and S-Video will not work.
- See page 35 to get more information on how to use the setup menu.

## Tour of the Remote Control

This remote control can also control most TVs. See page 38.

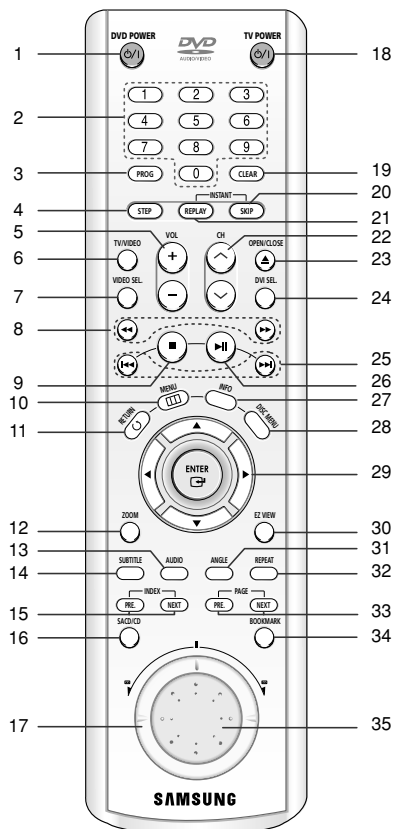

### DVD Function Buttons

1. **DVD POWER Button**
  - Turns the power on or off.
2. **NUMBER Buttons**
3. **PROG Button**
  - Allows you to program a specific order.
4. **STEP Button**
  - Advances play one frame at a time.
5. **VOL +/- Buttons**
  - Control volumes.
6. **TV/VIDEO Button**
  - Press to display all of the available video sources (i.e., TV, Cable, Video)
7. **VIDEO SEL. Button**
  - Selects Video output format.

8. **SEARCH Buttons (◀ / ▶)**
  - Allow you to search forward/backward through a disc.
9. **STOP Button (■)**
10. **MENU Button**
  - Brings up the DVD player's menu.
11. **RETURN Button**
  - Returns to a previous menu.
12. **ZOOM Button**
  - Enlarges DVD picture.
13. **AUDIO Button**
  - Use this button to access various audio functions on a disc.
14. **SUBTITLE Button**
15. **INDEX Buttons**
  - Use to skip the INDEX.
16. **SACD/CD Button**
  - Selects SACD or CD playback mode.
17. **SHUTTLE DIAL (Search mode)**
  - Performs fast motion play.
18. **TV POWER button**
  - Turns the TV's power on or off.
19. **CLEAR Button**
  - Use to remove menus or status displays from the screen.
20. **INSTANT SKIP Button**
  - This function skips playback ahead 10 seconds.
21. **INSTANT REPLAY Button**
  - This function is used to replay the previous 10 seconds of a movie from the current position.
22. **CH ^ / v buttons**
  - Channel selection.
23. **OPEN/CLOSE (▲) Button**
  - To open and close the disc tray.
24. **DVI SEL. Button**
  - DVI Output resolution setup.
25. **SKIP Buttons (◀◀ / ▶▶)**
  - Use to skip the title, chapter, or track.
26. **PLAY/PAUSE Button (▶||)**
  - Begin/Pause disc play.
27. **INFO Button**
  - Displays the current disc mode.
28. **DISC MENU Button**
  - Brings up the Disc menu.
29. **ENTER/DIRECTION Button (UP/DOWN or LEFT/RIGHT Buttons)**
  - This button functions as a toggle switch.
30. **EZ VIEW Button**
  - Easy View can convert Letter Box images to full screen viewing on your conventional TV.
31. **ANGLE Button**
  - Use to access various camera angles on a DVD.
32. **REPEAT Button**
  - Allows you to repeat play a title, chapter, track, or disc.
33. **PAGE Buttons**
  - Use to skip the PAGE.
34. **BOOKMARK Button**
35. **JOG DIAL (Step mode)**
  - Operates frame by frame play. In CD mode, performs track search.

ENG-8

## Choosing a Connection

The following shows examples of connections commonly used to connect the DVD player with a TV and other components.

### Before Connecting the DVD Player

- Always turn off the DVD player, TV, and other components before you connect or disconnect any cables.
- If you connected an external Audio System, turn on your Audio System and set it to the correct Audio Input.
- Refer to the owner's manual of the additional components you are connecting for more information on those particular components.

### Connection to an Audio System

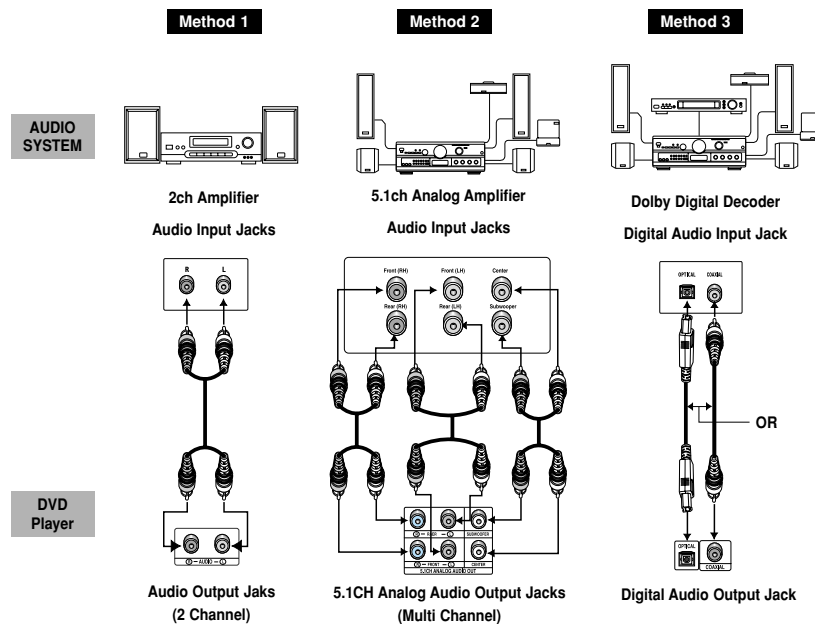

### Note

- DVD-AUDIO only plays back two channel audio through the Digital Audio out. Multi-channel DVD-Audio discs are output through the Analog outputs.
- SACD plays back only through the Analog outputs. (See page 32~33)

ENG-9

## Choosing a Connection

### Connection to a TV (For Video)

TV (Normal, Widescreen, Projection, etc..)

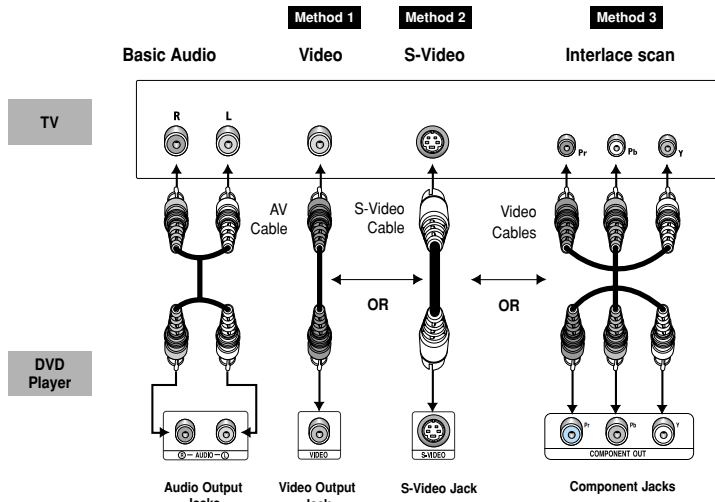

1. Connect a cable with the desired method.
2. Turn on your TV and DVD Player.
3. Set your TV the correct video input by pressing TV/VIDEO button on. (See page 38)
4. Select the video output according to the cable connection.  
If you use the VIDEO SEL. button, you can change easily video output in no disc mode.

#### Method 1

DVD Player + TV with Video Input Jack  
(The Video Output in Setup Menu must be set to S-Video or Component (I-SCAN).)

#### Method 2

DVD Player + TV with S-Video Input Jack  
(The Video Output in Setup Menu must be set to S-Video.)

#### Method 3

DVD Player + TV with Component Video Jacks  
(The Video Output in Setup Menu must be set to Component (I-SCAN).)

#### Note

- If you press the VIDEO SEL. button, Video output mode is changed in regular sequence in no disc mode. (S-Video → I-SCAN → P-SCAN & DVI)

## Choosing a Connection

### Connection to a TV (For Progressive scan, Digital Video)

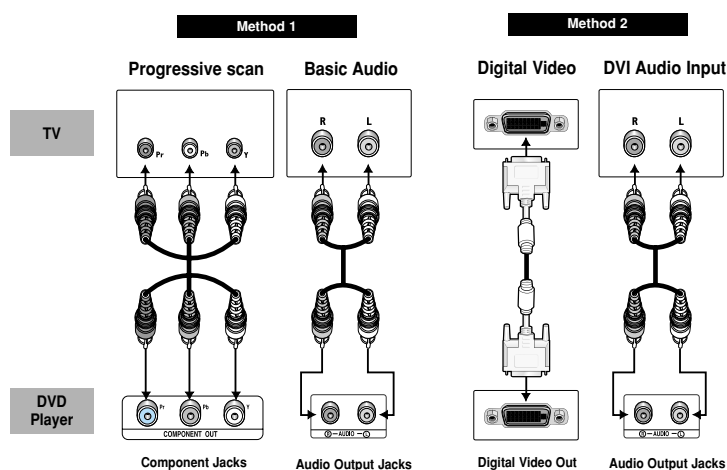

#### Method 1

DVD Player + TV with Component Video Jacks.  
(The Video Output in Setup Menu must be set to Component (P-SCAN) & DVI.)

#### Method 2

DVD Player + TV with DVI Jack.  
• Depending on your TV, your hookup for Method 2 may differ from the illustration.  
(The Video Output in Setup Menu must be set to Component (P-SCAN) & DVI.)

#### Important Note

- Consult your TV User's Manual to find out if your TV supports Progressive Scan.  
If Progressive Scan is supported, follow the TV User's Manual's instructions regarding Progressive Scan settings in the TV's menu system.
- When the Video output is Progressive Scan, Video and S-Video will not work.
- If you want to convert Video Output to Progressive Scan, select Component (P-SCAN) & DVI in SETUP menu and then select "Yes" within 10 seconds. Finally change the TV's external input to Component(576p/480p). (See Page 35)
- Use the VIDEO SEL. button to easily change the video output in no disc mode. (See page 10)
- Refer to your TV user's manual.

## Choosing a Connection

### DVI VIDEO Specifications

When you press the DVI SEL. button, in case of PAL TV system in setup menu 576p, 720p, 768p, 1080i ; [50Hz] are selected in order.

When you press the DVI SEL. button, in case of NTSC TV system in setup menu 480p, 720p, 768p, 1080i ; [60Hz] are selected in order.

The first press of the DVI SEL. button, brings up the current resolution.

The second press allows you to change the DVI output resolution.

\* The specific resolution of DVI output may not work depending on your TV.

\* Refer to the TV users manual.

### Important Note

- DVI (Digital Visual Interface)  
DVI is an interface to enable the digital transmission of video signals between various digital devices.  
Using DVI, the DVD player transmits a digital video signal and displays a vivid picture on a TV having a DVI jack.
- Description of the DVI connection  
DVI-D connector : digital signal only.  
DVI-I connector : digital and analog signal.
- Though the player uses a DVI-I cable, the player outputs only a pure digital signal to the TV.
- If TV does not support HDCP (High-bandwidth Digital content protection), snow noise or blue screen appears on the screen.
- Be careful that various connectors are similar to DVI connector, for example VESA PnD, VESA DFD and so on.
- Why does Samsung use DVI?  
Analog TVs require an analog video signal. However, when playing a DVD, the data transmitted to a TV is digital. Therefore either a digital-to-analog converter(in the dvd player) or an analog-to-digital converter (in the TV) is required. During this conversion, the picture quality is degraded due to noise and signal loss.  
DVI technology is superior because it requires no D/A conversion and is a pure digital signal from the player to your TV.
- What is the HDCP?  
HDCP(High-bandwidth Digital Content Protection) is a system for protecting DVD content outputted via DVI from being copied. It provides a secure digital link between a video source(PC, DVD, etc) and a display device(TV, projector . etc). Content is encrypted at the source device to prevent unauthorized copies from being made.

### PROGRESSIVE SCAN OUTPUT (525p/625p)

"CONSUMERS SHOULD NOTE THAT NOT ALL HIGH DEFINITION TELEVISION SETS ARE FULLY COMPATIBLE WITH THIS PRODUCT AND MAY CAUSE ARTIFACTS TO BE DISPLAYED IN THE PICTURE, IN CASE OF 525 OR 625 PROGRESSIVE SCAN PICTURE PROBLEMS, IT IS RECOMMENDED THAT THE USER SWITCH THE CONNECTION TO THE 'STANDARD DEFINITION' OUTPUT. IF THERE ARE QUESTIONS REGARDING OUR TV SET COMPATIBILITY WITH THIS MODEL 525p AND 625p DVD PLAYER, PLEASE CONTACT OUR CUSTOMER SERVICE CENTER."

## Playing a Disc

### Before Play

- Turn on your TV and set it to the correct Video Input by pressing TV/VIDEO button on the TV remote control.
- If you connected an external Audio System, turn on your Audio System and set it to the correct Audio Input.

After plugging in the player, the first time you press the DVD POWER button, this screen comes up :

If you want to select a language, press a NUMBER button. (This screen will only appear when you plug in the player for the first time.) If the language for the startup screen is not set, the settings may change whenever you turn the power on or off. Therefore, make sure that you select the language you want to use.



### Play

1. Press the OPEN/CLOSE button.  
The STANDBY indicator light goes out and the tray opens.
2. Place a disc gently into the tray with the disc's label facing up.
3. Press the PLAY/PAUSE (▶||) button or OPEN/CLOSE button to close the disc tray.
4. Stopping Play  
Press the STOP (■) button during play.
5. Removing Disc  
Press the OPEN/CLOSE button.
6. Pausing Play  
Press the PLAY/PAUSE (▶||) or STEP button on the remote during play.  
- Screen stops, no sound.  
- To resume, press the PLAY/PAUSE (▶||) button once again.

7. Step Motion Play  
(Except CD/DVD-AUDIO/SACD)  
Turn the Jog dial clockwise or press the STEP button on the remote during play.  
- Each time the button is pressed or Jog Dial is turned, a new frame will appear.  
- No sound is heard during STEP mode.  
- Press PLAY/PAUSE (▶||) button to resume normal play.  
- You can only perform step motion play in the forward direction.
8. Slow Motion Play  
(Except CD/DVD-AUDIO/SACD)  
Press the FWD SEARCH (▶▶) button on the remote during PAUSE or STEP mode.  
- By pressing the FWD SEARCH (▶▶) button, you can select slow motion play for 1/8, 1/4 or 1/2 of normal speed.  
- No sound is heard during slow mode.  
- Press PLAY/PAUSE (▶||) to resume normal play.  
- Reverse slow motion play will not work.

### RESUME function

When you stop disc play, the player remembers where you stopped, so when you press PLAY/PAUSE (▶||) button again, it will pick up where you left off. (unless the disc is removed or the player is unplugged, or if you press the STOP (■) button twice.)

### Note

- If the player is left for about 5 minutes in pause mode, it will stop.
- If the player is left in the stop mode for more than about 30 minutes, the power will automatically shut off. (Automatic Power-Off Function)
- If the player is left in the stop mode for more than one minute without any user interaction, a screen saver will be activated. Press the PLAY/PAUSE (▶||) button to resume normal play.
- This ⓪ icon indicates an invalid button press.

## Using the Search & Skip Functions

During play, you can search quickly through a chapter or track or use the skip function to jump to the next selection.

### Searching through a Chapter or Track

During play, press the SERACH (◀◀ or ▶▶) button and press again to search at a faster speed.

- You can also use the Shuttle dial on the remote by turning. (2X, 4X, 8X, 16X, 32X, 128X)
- In case of SACD, when the clips menu is off, you can use this function. (See page 23)

DVD	2X, 8X, 32X, 128X
VCD	4X, 8X
CD/SACD/DVD-AUDIO	2X, 4X, 8X

### Skipping Tracks

During play, press the ◀◀ or ▶▶ button.

- When playing a DVD if you press the ▶▶ button, it moves to the next chapter. If you press the ◀◀ button, it moves to the beginning of the chapter. One more press makes it move to the beginning of the previous chapter.
- When playing a VCD 2.0 in Menu Off mode, a VCD 1.1, SACD/ DVD-AUDIO or a CD, if you press the ▶▶ button, it moves to the next track. If you press the ◀◀ button, it moves to the beginning of the track. One more press makes it move to the beginning of the previous track.
- If a track exceeds 15 minutes when playing a VCD and you press the ▶▶ button, it moves forward 5 minutes, in menu off mode. If you press the ◀◀ button, it moves backward 5 minutes.

### Note

- When playing a VCD 2.0, you can choose Menu On or Menu Off by using the DISC MENU button.

## Using the Display Function

### When Playing a DVD/VCD/CD

- During play, press the INFO button on the remote.
- Use the UP/DOWN buttons to select the desired item.
- Use the LEFT/RIGHT buttons to make the desired setup and then press ENTER.
  - You may use the number buttons of the remote control to directly access a title, chapter or to start the playback from the desired time.
- To make the screen disappear, press the INFO button again.

#### DVD



#### VCD



#### CD



## Using the Display Function



To access the desired title when there is more than one in the disc. For example, if there is more than one movie on a DVD, each movie will be identified.



Most DVD discs are recorded in chapters so that you can quickly find a specific passage (similar to tracks on an audio CD).



Allows playback of the film from a desired time. You must enter the starting time as a reference.



Refers to the language of the film soundtrack. In the example, the soundtrack is played in English 5.1CH. A DVD disc can have up to eight different soundtracks.



Refers to the subtitle languages available in the disc. You will be able to choose the subtitle languages or, if you prefer, turn them off from the screen. A DVD disc can have up to 32 different subtitles.

### Note

- When VCD 2.0 is in Menu Off mode only, this function works. (See page 14)

## Using the Disc and Title Menu

### Using the Disc Menu

- During the playback of a DVD disc, press the MENU button on the remote.
- Select **Disc Menu** using the UP/DOWN buttons, then press the RIGHT or ENTER button.



### Using the Title Menu

- During the playback of a DVD disc, press the MENU button on the remote.
- Select **Title Menu** using the UP/DOWN buttons, then press the RIGHT or ENTER button.



### Note

- Depending on a disc, the Title and Disc Menus may not work.
- Title Menu will only be displayed if there are at least two titles in the disc.
- You can also use the Disc Menu, using the DISC MENU button on the remote.
- In VCD 2.0, the DISC MENU button is used to select Menu On or Menu Off mode.



## Using the Function Menu

### Using the Function Menu

- Press the MENU button during playback.
- Use the UP/DOWN buttons to highlight **Function**, then press the RIGHT or ENTER button.
- Function selection screen appears: Info, Zoom, Bookmark, Repeat and EZ View.
  - Info (See Page 14~15)
  - Zoom (See Page 22)
  - Bookmark (See Page 21)
  - Repeat (See Page 16)
  - EZ View (See Page 18)
- Use the UP/DOWN button to highlight one of the 5 functions. Then press the RIGHT or ENTER button to access the function.



### Note

- You can also directly select these functions using their respective buttons on the remote.

## Repeat Play

Repeat the current track, chapter, title, a chosen section (A-B), or all of the disc.

- Press the REPEAT button on the remote. Repeat screen appears.
- Select Chapter, Title or A-B using the LEFT/RIGHT buttons.
  - Chapter ( ): repeats the chapter that is playing.
  - Title ( ): repeats the title that is playing.
  - A-B : repeats a segment of the disc that you select.
- A-B REPEAT
  - Press ENTER at the point where you want the repeat play to start (A).
  - Press ENTER at the point where you want the repeat play to stop (B).
  - To terminate the function, press the 'CLEAR' button.
  - A-B REPEAT does not allow you to set point (B) until at least 5 seconds has elapsed after point (A) has been set.

### DVD



### VCD/CD



- Press ENTER.
- To return to normal play, press REPEAT again, then press the LEFT/RIGHT buttons to select Off and press ENTER.

### Note

- DVD repeats play by chapter or title, CD and VCD repeat play by disc or track.
- Depending on a disc, the Repeat function may not work.
- When VCD 2.0 is in Menu Off mode only, this function works. (See page 14)

## Slow Repeat Play

This feature allows you to slowly repeat scenes containing sports, dancing, musical instruments being played etc. so you can study them more closely.

### When playing a DVD/VCD

- During play, press the PLAY/PAUSE ( ) button.
- Press the FWD SEARCH ( ) button on the remote during PAUSE or STEP mode.
- Press the REPEAT button on the remote. Repeat screen appears.
- Select A-B using the LEFT/RIGHT buttons.
- Press ENTER at the point where you want the repeat play to start (A).
  - A-B REPEAT does not allow you to set point (B) until at least 5 seconds has elapsed after point (A) has been set.
- Press ENTER at the point where you want repeat play to stop (B).
- To return to normal play, press the CLEAR button and then press the PLAY/PAUSE ( ) button.

### Note

- The disc will play from A to B repeatedly at the speed you chose.
- When VCD 2.0 is in Menu Off mode only, this function works. (See page 14)

## Program Play & Random Play

### Program Play (CD)

- Press the PROG button.
- Use the LEFT/RIGHT buttons to select PROGRAM. Press the ENTER button.
- Use the LEFT/RIGHT/UP/DOWN buttons to select the first track to add to the program. Press the ENTER button. The selection numbers appear in the Program Order box.
- Press the PLAY/PAUSE ( ) button. The disc will be played in programmed order.

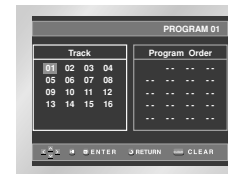

### Random Play (CD)

- Press the PROG button.
- Use the LEFT/RIGHT buttons to select RANDOM. Press the ENTER button.



### Note

- Depending on a disc, the Program and Random Play functions may not work.
- This unit can support a maximum of 20 programmed tracks.
- While in playback mode, press the CLEAR button on the remote control to cancel Programmed Play or Random Play.

## Adjusting the Aspect Ratio (EZ View)

### To play back using aspect ratio (DVD)

Press the EZ VIEW button.

- The screen size changes when the button is pressed repeatedly.
- The screen zoom mode operates differently depending on a screen setting in the initial setup menu.
- To ensure correct operation of the EZ VIEW button, you should set the correct aspect ratio in the initial setup (See page 34).

### If you are using a 16:9 TV

#### 1. For 16:9 aspect ratio discs

##### • Wide Screen

Displays the content of the DVD title in 16:9 aspect ratio.

##### • Screen Fit

The top and bottom of the screen are cut off. When playing a 2.35:1 aspect ratio disc, the black bars at the top and bottom of the screen will disappear. The picture will look vertically stretched. (Depending on a type of disc, the black bars may not disappear completely.)

##### • Zoom Fit

The top, bottom, left and right of the screen are cut off and the central portion of the screen is enlarged.

#### 2. For 4:3 aspect ratio discs

##### • Normal Wide

Displays the content of the DVD title in 16:9 aspect ratio. The picture will look horizontally stretched.

##### • Screen Fit

The top and bottom of the screen are cut off and the full screen appears. The picture will look vertically stretched.

##### • Zoom Fit

The top, bottom, left and right of the screen are cut off and the central portion of the screen is enlarged.

##### • Vertical Fit

When a 4:3 DVD is viewed on a 16:9 TV, black bars will appear at the left and right of the screen in order to prevent the picture from looking horizontally stretched.

### If you are using a 4:3 TV

#### 1. For 16:9 aspect ratio discs

##### • 4:3 Letter Box

Displays the content of the DVD title in 16:9 aspect ratio. The black bars will appear at the top and bottom of the screen.

##### • 4:3 Pan Scan

The left and right of the screen are cut off and displays the central portion of the 16:9 screen.

##### • Screen Fit

The top and bottom of the screen are cut off and the full screen appears.

The picture will look vertically stretched.

##### • Zoom Fit

The top, bottom, left and right of the screen are cut off and the central portion of the screen is enlarged.

#### 2. For 4:3 aspect ratio discs

##### • Normal Screen

Displays the content of the DVD title in 4:3 aspect ratio.

##### • Screen Fit

The top and bottom of the screen are cut off and the full screen appears.

The picture would look vertically stretched.

##### • Zoom Fit

The top, bottom, left and right of the screen are cut off and the central portion of the screen is enlarged.

### Note

- This function may behave differently depending on a type of disc.

## Selecting the Audio Language

You can select a desired audio quickly and easily with the AUDIO button.

### Using the AUDIO button

1. Press the AUDIO button.
2. The Audio changes when the button is pressed repeatedly.  
The audio languages are represented by abbreviations.

DVD



- In case of a VCD or CD, you can select among Stereo, Right or Left.

VCD/CD

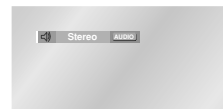

- Use the LEFT/RIGHT buttons to select the desired Audio on a MPEG4 then press the ENTER.

MPEG4



3. To remove the AUDIO icon, press the CLEAR or RETURN button.

### Note

- This function depends on what audios are encoded on the disc and may not work.
- A DVD disc can contain up to 8 audio languages.
- **How to have the same audio language come up whenever you play a DVD;**  
Refer to "Setting Up the Language Features" on page 31.

## Selecting the Subtitle Language

You can select a desired subtitle quickly and easily with the SUBTITLE button.

### Using the SUBTITLE button

1. Press the SUBTITLE button.  
- The subtitle languages are represented by abbreviations.
2. The subtitle changes when the button is pressed repeatedly.

DVD



- Use the LEFT/RIGHT buttons to select the desired subtitle language on a MPEG4 then press the ENTER.

MPEG4



3. To remove the SUBTITLE icon, press the CLEAR or RETURN button.

### Note

- This function depends on what subtitles are encoded on the disc and may not work.
- A DVD disc can contain up to 32 subtitle languages.
- **How to have the same subtitle language come up whenever you play a DVD;**  
Refer to "Setting Up the Language Features" on page 32.

## Changing the Camera Angle

When a DVD contains multiple angles of a particular scene, you can use the ANGLE function.

### Using the ANGLE button

If the disc contains multiple angles, the ANGLE mark appears on the screen.

1. Press the ANGLE button, then ANGLE icon will appear with the current angle number and the number of angles available.
2. Press the ANGLE button repeatedly to the desired angle.
3. To remove the ANGLE icon, press the CLEAR or RETURN button.

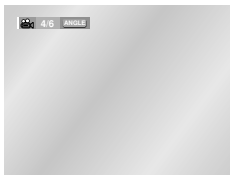

### Note

- If the disc has only one angle, this feature won't work. Currently, very few discs have this feature.

## Using the Instant Replay/Skip Function

### Using the Instant Replay function (DVD)

If you miss a scene, you can see it again using this function.

If you press the INSTANT REPLAY button, the current scene moves backward about 10 seconds, and plays back.

\* Depending on a disc, the Instant Replay function may not work.

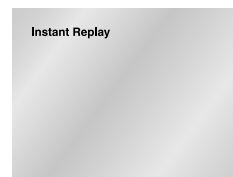

### Using the Instant Skip function (DVD)

Use this function to skip playback about 10 seconds ahead of the current scene.

Press the INSTANT SKIP button.

- Playback will skip ahead 10 seconds.
- Depending on a disc, this function may not work.

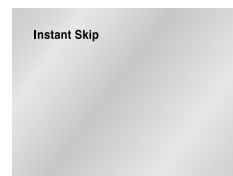

## Using the Bookmark Function

This feature lets you bookmark sections of a DVD or VCD (Menu Off mode) so you can quickly find them at a later time.

### Using the Bookmark Function (DVD/VCD)

1. During play, press the BOOKMARK button on the remote.
2. Use the LEFT/RIGHT buttons to move to the desired bookmark icon.
3. When you reach the scene you want to mark, press the ENTER button. The icon will change to a number (1, 2, or 3).
4. Press the BOOKMARK button to turn Off the display.



### Recalling a Marked Scene

1. During play, press the BOOKMARK button on the remote.
2. Use the LEFT/RIGHT buttons to select a marked scene.
3. Press the PLAY/PAUSE (▶||) buttons to skip to the marked scene.



### Clearing a Bookmark

1. During play, press the BOOKMARK button on the remote.
2. Use the LEFT/RIGHT buttons to select the bookmark number you want to delete.
3. Press the CLEAR button to delete a bookmark number. Press the BOOKMARK button to turn Off the display.

### Note

- Up to three scenes may be marked at a time.
- When VCD 2.0 is in Menu Off mode only, this function works. (See page 14)
- Depending on a disc, the Bookmark function may not work.

## Using the Zoom Function

### Using the Zoom Function (DVD/VCD)

- During play or pause mode, press the ZOOM button on the remote.  
A Zoom mark will be displayed on screen.
- Use the UP/DOWN or LEFT/RIGHT buttons to select the part of the screen you want to zoom in on.
- Press the ENTER button.  
- During DVD play, press ENTER to zoom in 2X/4X/2X/Normal in order.  
- During VCD play, press ENTER to zoom in 2X/Normal in order.

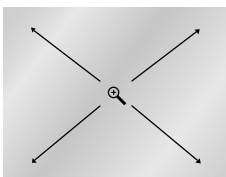

## SACD Playback

- Open the disc tray.
- Place the SACD disc on the tray.  
- Place the SACD disc with the labeled side up.
- Close the tray.  
- The tray closes and you should get a screen that looks like the one below.



### SACD Clips Menu On Play Function

- Use the UP/DOWN buttons to select a music title.
- Press the ENTER button to begin playback of the music title.  
- If you want to use the Repeat Function, press the REPEAT button to change the mode, such as Off, Track, Disc.  
\*Off : Normal Playback  
\*Track : Repeats the current music title.  
\*Disc : Repeats the music titles in the SACD.  
- If you want to see information about the Disc title and Artist, press the INFO button.  
- If you want to convert into regular CD mode, press the SACD/CD button.  
- During play or stop mode, you can change the 2CH or MULTI mode by using LEFT/RIGHT buttons.  
(You can use this function when SACD disc includes multi channel and 2 channel audio format.)

## SACD Playback

### SACD Clips Menu Off Play Function

- In Stop mode, press the DISC MENU button until the Clips menu is off.
- During playback, press the INFO button and the screen below appears.
- Use the UP/DOWN buttons to select the desired item.



- Use the LEFT/RIGHT buttons to make the desired setup and then press ENTER.  
• You may use the number buttons of the remote control to directly access a track and to start the playback from the desired time.

 **Track** To access the desired Track when there is more than one in the disc.

 **Time** Allows playback from a desired time by using the number buttons.

 **Audio** If you want to change the 2channel or multi channel in play or stop mode, press AUDIO button.  
- You can use this function when SACD disc includes multi channel and 2 channel audio format.  
• 2CH : L, R  
• MULTI : F/L, F/R, R/L, R/R, C/T, S/W

- To make the screen disappear, press the INFO button again.

### CD Layer Play Function

During SACD playback, press the SACD/CD button to playback the CD layer of a dual layer SACD disc. (Refer to the page 14 for setting CD playback Function).

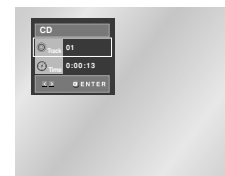

 **Track** To access the desired Track when there is more than one in the disc.

 **Time** Allows playback from a desired time. You must enter the starting time as a reference.

#### Note

- Some SACD discs do not include a CD layer.
- Depending on a disc, this function may not work.

## DVD AUDIO Playback

1. Open the disc tray.
2. Place the DVD AUDIO disc on the tray.  
- Place the DVD AUDIO disc with the labeled side up.
3. Close the tray.  
- The tray closes and disc plays.

### Using the Display Function

1. During play, press the INFO button on the remote.
2. Use the UP/DOWN buttons to select the desired item.
3. Use the LEFT/RIGHT buttons to make the desired setup and then press ENTER.  
• You may use the number buttons of the remote control to directly access a Group, Track, Page or to start the playback from the desired time.
4. To make the screen disappear, press the INFO button again.



### Note

Some DVD-AUDIO discs don't audio down-mixing. These discs always output 5.1ch analog audio regardless of audio setup.



Most DVD AUDIO discs are recorded in Group, you can change Groups with this Function.

### Note

- \* Bonus Group playback.
- Some DVD AUDIO discs have Bonus groups. If you want to play a Bonus group, you must enter the Bonus Group code. The code is usually on the DVD AUDIO disc case.



To access the desired Track when there is more than one on the DVD AUDIO disc.



If pages are included with the DVD-AUDIO, you can see this icon. To access the desired page, you can use this Function.



If a slide show is included with the DVD-AUDIO, you can see this icon. In this case you cannot use PAGE PRE./NEXT buttons.



If a video zone is included with the DVD-AUDIO, you can see this icon. In this case you cannot use PAGE PRE./NEXT buttons.



Allows playback of the music from a desired time by using the number buttons.

### Page\_Index Function

1. Use PAGE PRE./NEXT buttons to Skip the Page when there is more than one in a group.  
• Some DVD-AUDIO discs include a slide show. In the slide show mode, this function can not use.  
• PAGE is still images. You can see the still images when playback DVD-AUDIO disc.
2. Use INDEX PRE./NEXT buttons to Skip the Index when there is more than one in a track.

**Note** Depending on a disc, this function may not work.

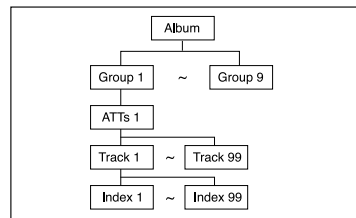

## DVD AUDIO Playback

### REPEAT Play

1. Press the REPEAT button on the remote during Playback.
2. Select Title ( ), Group ( ) using the LEFT/RIGHT button.
3. Press ENTER.



### AUDIO Format Display

During DVD AUDIO playback, press the AUDIO button to see AUDIO Format information.

- LPCM : Linear Pulse Code Modulation.  
Not compressed Audio data format.
- PPCM : Packet Pulse Code Modulation.  
Lossless compressed Audio data format.



### Note

Some DVD-AUDIO discs don't allow audio down-mixing. These discs always output 5.1ch analog audio regardless of audio setup.

## Clips Menu for MP3/WMA/JPEG/MPEG4

Discs with MP3/WMA/JPEG/MPEG4 contain individual songs, pictures or movies that can be organized into folders as shown below. They are similar to how you use your computer to put files into different folders.

1. Open the disc tray.
2. Place the disc on the tray.  
- Place the disc with the labeled side up.
3. Close the tray.  
- The tray closes and you should get a screen that looks like the one below.



Parent Folder, Current Folder and Peer Folders | Folders and Files in Current Folder

- : Name of currently playing file.
- : Current Playback Time.
- : Current Playback Mode : There are 4 modes. They can be selected in order by pressing the REPEAT button.  
- Off : Normal Playback  
- Track : Repeats the current track.  
- Folder : Repeats the current folder.  
- Random : Files in the disc will be played in random order.

**Note** When you play a MPEG4(AVI) file, refer to page 27.

- : MP3 file icon.      • : AVI file icon.
- : WMA file icon.      • : Folder icon.
- : JPEG file icon.      • : Current Folder icon.

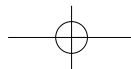

## Folder Selection

The folder can only be selected in the Stop mode.

### To select the Parent Folder

Press the RETURN button to go to parent folder, or use the UP/DOWN buttons to select “..” and press ENTER to go to the parent folder.

### To select the Peer Folder

Use the LEFT/RIGHT buttons to highlight left window. Use the UP/DOWN buttons to select the desired folder, then press ENTER.

### To select the Sub-Folder

Use the LEFT/RIGHT buttons to highlight right window. Use the UP/DOWN buttons to select the desired folder, then press ENTER.

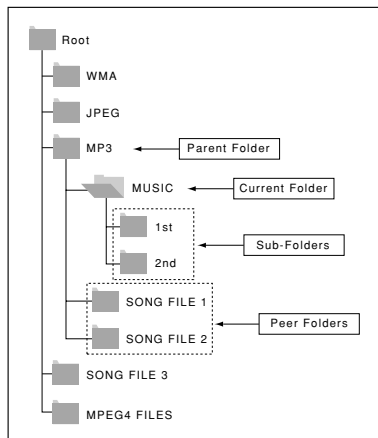

## MP3/WMA Playback

1. Open the disc tray.
2. Place the disc on the tray.  
- Place the disc with the labeled side up.
3. Close the tray.  
- The tray closes and you should get a screen that looks like the one below.

### MP3/WMA Play Function

1. Select the desired folder.
2. Use the UP/DOWN or LEFT/RIGHT buttons to select a song file.
3. Press ENTER to begin playback of the song file.



### Repeat/Random playback

Press the REPEAT button to change playback mode. There are 4 modes, such as Off, Track, Folder and Random.

- Off : Normal Playback
- Track : Repeats the current song file.
- Folder : Repeats the song files which have the same extension in the current folder.
- Random : Song files which have the same extension will be played in random order.

\* To resume normal play, press the CLEAR button.

## MP3/WMA Playback

### CD-R MP3/WMA discs

When you record MP3 or WMA files on CD-R, please refer to the following.

#### Your MP3 or WMA files should be ISO 9660 or JOLIET format.

ISO 9660 format and Joliet MP3 or WMA files are compatible with Microsoft's DOS and Windows, and with Apple's Mac. This format is the most widely used.

#### When naming your MP3 or WMA files, do not exceed 8 characters, and enter ".mp3, .wma" as the file extension.

General name format of: Title.mp3, or Title.wma. When composing your title, make sure that you use 8 characters or less, have no spaces in the name, and avoid the use of special characters including: (,/, \, =, +).

#### Use a decompression transfer rate of at least 128 Kbps when recording MP3 files.

Sound quality with MP3 files basically depends on the rate of compression/decompression you choose. Getting CD audio sound requires an analog/digital sampling rate, that is conversion to MP3 format, of at least 128 Kbps and up to 160 Kbps. However, choosing higher rates, like 192 Kbps or more, only rarely give better sound quality. Conversely, files with decompression rates below 128 Kbps will not be played properly.

#### Use a decompression transfer rate of at least 64Kbps when recording WMA files.

Sound quality with WMA files basically depends on the rate of compression/decompression you choose. Getting CD audio sound requires an analog/digital sampling rate, that is conversion to WMA format, of at least 64Kbps and up to 192Kbps. Conversely, files with decompression rates below 64Kbps or over 192Kbps will not be played properly.

#### Do not try recording copyright protected MP3 files.

Certain "secured" files are encrypted and code protected to prevent illegal copying. These files are of the following types: Windows Media™ (registered trade mark of Microsoft Inc) and SDMI™ (registered trade mark of The SDMI Foundation). You cannot copy such files.

**Important:** The above recommendations cannot be taken as a guarantee that the DVD player will play MP3 recordings, or as an assurance of sound quality. You should note that certain technologies and methods for MP3 file recording on CD-Rs prevent optimal playback of these files on your DVD player (degraded sound quality and in some cases, inability of the player to read the files).

This unit can play a maximum of 3000 files and 300 folders per disc.

## MPEG4 Playback

1. Open the disc tray.
2. Place the disc on the tray.  
- Place the disc with the labeled side up.
3. Close the tray.  
- The tray closes and you should get a screen that looks like the one below.

### MPEG4 Play Function

AVI files are used to contain the audio and video data. Only AVI format files with the ".avi" extensions can be played.

1. Select the desired folder. (See page 26 to select the folder)
2. Use the UP/DOWN or LEFT/RIGHT buttons to select an avi file (DivX/XviD) and then press the ENTER button.



### Repeat Playback

Press the REPEAT button to change playback mode. There are 4 modes, such as Off, Folder, Title and A-B (a distance between two points appointed by user).



- Folder (FD) : repeats the AVI files which have the same extension in the current folder.
- Title (01) : repeats the title that is playing.
- A-B : repeats a segment of the file that you select.

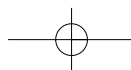
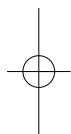

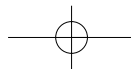

## MPEG4 Playback

### Using the Display Function

- During play, press the INFO button on the remote.
- Use the UP/DOWN buttons to select the desired item.
- Use the LEFT/RIGHT buttons to make the desired setup and then press ENTER.
  - You may use the number buttons of the remote control to directly access a title or to start the playback from the desired time.
- To make the screen disappear, press the INFO button again.



**Title** To access the desired title when there is more than one in the disc.

**Time** Allows playback of the film from a desired time. You must enter the starting time as a reference.

**Audio** To select the desired language of the title soundtrack. The MP3, AC3 and WMA are supported. You can use this function using the AUDIO button. (See page 19)

**Subtitle** You will be able to choose the subtitle languages or, if you prefer, turn them off from the screen. You can use this function using the SUBTITLE button. (See page 19)

**Size** File Size has a relationship with resolution of a title. The larger file size is, the higher resolution is displayed. If the file resolution is small, it scales up automatically. So you can see the larger screen.

### MPEG4 Function Description

Function	Description	Reference page
Skip (◀◀ or ▶▶)	During play, press the ◀◀ or ▶▶ button, it moves forward or backward 5 minutes.	-
Search (◀◀ or ▶▶)	During play, press the SERACH (◀◀ or ▶▶) button and press again to search at a faster speed. Allows you to search at a faster speed in an AVI file. (2X, 4X, 8X)	-
Slow Motion Play	Allows you to search at a slower speed in an AVI file. (1/8X, 1/4X, 1/2X)	P 13
Step Motion Play	Each time the STEP button is pressed, a new frame will appear.	P 13
ZOOM	2X/4X/2X/Normal in order	P 22

- These functions may not work depending on MPEG4 file.

### CD-R AVI file

This unit can play the following video compression formats within the AVI file format:

- DivX 3.11 contents
- DivX 4 contents (Based on MPEG-4 Simple Profile)
- DivX 5 contents (MPEG-4 simple profile plus additional features such as bi-directional frames. Qpel and GMC are also supported)
- XviD MPEG-4 compliant Contents.

This unit supports all resolutions up to maximum below.

DivX3.11 & DivX4 & XviD	DivX5
Bitrate may fluctuate: Device may skip decoding the high bitrate portions and begin decoding again when Bitrate returns to normal.	720 x 480 @30fps 720 x 576 @25fps : Maximum bitrate : 4Mbps

### Note

- Some MPEG-4 files created on a personal computer may not be play back. That is why Codec Type, Version and Higher resolution over specification is not supported.
- This unit supports CD-R/RW written in MPEG4 in accordance with the "ISO9660 format".

## Picture CD Playback

- Select the desired folder. (See page 26 to select the folder)
- Use the UP/DOWN buttons to select a Picture file in clips menu and then press the ENTER button. You should get a screen that looks like the one below.



- Use the INFO button on the remote control to select the menu you want to view and then press the ENTER button.

: Returns to the Album Screen.

To see the next 6 pictures, press the ▶▶ button.

To see the previous 6 pictures, press the ◀◀ button.

: Each time the ENTER button is pressed, the picture rotates 90 degrees clockwise.

: Each time the ENTER button is pressed, the picture is enlarged up to 4X. (Normal → 2X → 4X → 2X → Normal)

: The unit enters slide show mode.

\*Before beginning the Slide Show, the picture interval must be set.

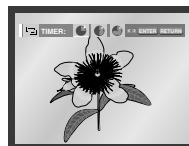

: When this icon is selected and ENTER is pressed, the pictures change automatically with about a 6 second interval.

: The pictures change automatically with about a 12 second interval.

: The pictures change automatically with about a 18 second interval.

\*Depending on a file size, the amount of time between each picture may be different from the manual.

\*If you don't press any button, the slide show will start automatically in about 10 seconds by default.

### Note

- If no buttons on the remote control pressed for 10 seconds, the menu will disappear. Press the INFO button on the remote control to display the menu again.
- Press the STOP button to return to the clips menu.
- When playing a Kodak Picture CD, the unit displays the Photo directly, not the clips menu.

### CD-R JPEG Discs

- Only files with the ".jpg" and ".JPG" extensions can be played.
- If the disc is not closed, it will take longer to start playing and not all of the recorded files may be played.
- Only CD-R discs with JPEG files in ISO 9660 or Joliet format can be played.
- The name of the JPEG file may not be longer than 8 characters and should contain no blank spaces or special characters (. / = +).
- Only a consecutively written multisession disc can be played. If there is a blank segment in the multisession disc, the disc can be played only up to the blank segment.
- A maximum of 3000 images can be stored on a single CD.
- Kodak Picture CDs are recommended.
- When playing a Kodak Picture CD, only the JPEG files in the pictures folder can be played.
- Kodak Picture CD : The JPEG files in the pictures folder can be played automatically.
- Konica Picture CD : If you want to see the Picture, select the JPEG files in the clips menu.
- Fuji Picture CD : If you want to see the Picture, select the JPEG files in the clips menu.
- QSS Picture CD : The unit cannot play QSS Picture CD.
- If the number of files in 1 Disc is over 3000, only 3000 JPEG files can be played.
- If the number of folders in 1 Disc is over 300, only JPEG files in 300 folders can be played.

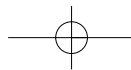

## Using the Setup Menu

The Setup menu lets you customize your DVD player by allowing you to select various language preferences, set up a parental level, even adjust the player to the type of television screen you have.

1. With the unit in Stop mode, press the MENU button on the remote. Select **Setup** using UP/DOWN buttons, then press the RIGHT or ENTER button.

❶ **Language Setup** : Setup of the Language.

❷ **Audio Setup** : Setup of the Audio Options.

❸ **Display Setup** : Setup of the Display Options. Use to select which type of screen you want to watch and several display options.

❹ **Parental Setup** : Setup of the Parental Level. Allows users to set the level necessary to prevent children from viewing unsuitable movies such as those with violence, adult subject matter, etc.

❺ **DivX(R) Registration** : Please use the Registration code to register this player with the DivX(R) Video on Demand service. This will allow you to rent and purchase videos using the DivX(R) Video On Demand format. To learn more go to [www.divx.com/vod](http://www.divx.com/vod).



2. Use the UP/DOWN buttons on the remote to access the different features.
3. Press the ENTER or RIGHT button to access the sub features.

To make the setup screen disappear after setting up, press the MENU button again.

### Note

Depending on a disc, some Setup Menu selections may not work.

## Setting Up the Language Features

If you set the player menu, disc menu, audio and subtitle language in advance, they will come up automatically every time you watch a movie.

### Using the Player Menu Language

1. With the unit in Stop mode, press the MENU button.
2. Select **Setup** using UP/DOWN buttons, then press the RIGHT or ENTER button.
3. Select **Language Setup** using UP/DOWN buttons, then press the RIGHT or ENTER button.



4. Select **Player Menu** using UP/DOWN buttons, then press the RIGHT or ENTER button.

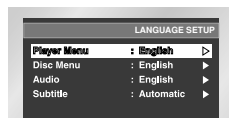

5. Use the UP/DOWN buttons to select the desired language.



6. Press the ENTER button.
  - The language is selected and the screen returns to Language Setup menu.
  - To make the SETUP menu disappear, press the RETURN or LEFT button.

## Setting Up the Language Features

### Using the Disc Menu Language

This function changes the text language only on the disc menu screens.

1. With the unit in Stop mode, press the MENU button.
2. Select **Setup** using UP/DOWN buttons, then press the RIGHT or ENTER button.
3. Select **Language Setup** using UP/DOWN buttons, then press the RIGHT or ENTER button.
4. Select **Disc Menu** using UP/DOWN buttons, then press the RIGHT or ENTER button.
5. Use the UP/DOWN buttons to select the desired language.
  - Select "Others" if the language you want is not listed.



6. Press the ENTER button.
  - The language is selected and the screen returns to Language Setup menu.

### Using the Audio Language

1. With the unit in Stop mode, press the MENU button.
2. Select **Setup** using UP/DOWN buttons, then press the RIGHT or ENTER button.
3. Select **Language Setup** using UP/DOWN buttons, then press the RIGHT or ENTER button.
4. Select **Audio** using UP/DOWN buttons, then press the RIGHT or ENTER button.
5. Use the UP/DOWN buttons to select the desired language.
  - Select "Original" if you want the default soundtrack language to be the original language the disc is recorded in.
  - Select "Others" if the language you want is not listed.



6. Press the ENTER button.
  - The language is selected and the screen returns to Language Setup menu.



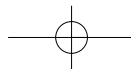

## Setting Up the Language Features

### Using the Subtitle Language

1. With the unit in Stop mode, press the MENU button.
2. Select **Setup** using UP/DOWN buttons, then press the RIGHT or ENTER button.
3. Select **Language Setup** using UP/DOWN buttons, then press the RIGHT or ENTER button.
4. Select **Subtitle** using UP/DOWN buttons, then press the RIGHT or ENTER button.
5. Use the UP/DOWN buttons to select the desired language.
  - Select "Automatic" if you want the subtitle language to be the same as the language selected as the audio preference.
  - Select "Others" if the language you want is not listed. Some discs may not contain the language you select as your initial language; in that case the disc will use its original language setting.



6. Press the ENTER button.
  - The language is selected and the screen returns to Language Setup menu.

### Note

- If the selected language is not recorded on the disc, the original pre-recorded language is selected.
- **How to make the SETUP menu disappear or return to menu screen during set up;** Press RETURN or LEFT button.

## Setting Up the Audio Options

1. With the unit in Stop mode, press the MENU button.
2. Select **Setup** using UP/DOWN buttons, then press the RIGHT or ENTER button.
3. Select **Audio Setup** using UP/DOWN buttons, then press the RIGHT or ENTER button.

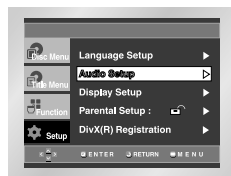

4. Use the UP/DOWN buttons to select the desired item. Then press the RIGHT or ENTER button.

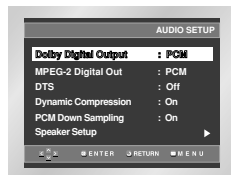

### 1 Dolby Digital Output

1. PCM : Converts to PCM(2CH) 48kHz audio. Select PCM when using the Analog Audio Outputs.
2. Bitstream : Converts to Dolby Digital Bitstream (5.1CH). Select Bitstream when using the Digital Audio Output.

### Note

- Even when PCM Down sampling is Off
- Some discs will only output down sampled audio through the digital outputs.
- High sampling rate DVD-Audio discs (192KHz or 176.4KHz) always output audio down sampled to 96KHz or 88.2KHz through the digital outputs.
- When playing LPCM or PPCM DVD protected by copyright. If digital audio source is 48KHz/16bit the Digital output is mute.

### 2 MPEG-2 Digital Out

1. PCM : Converts to PCM(2CH) audio. Select PCM when using the Analog Audio Outputs.
2. Bitstream : Converts to MPEG-2 Digital Bitstream (5.1CH or 7.1CH). Select Bitstream when using the Digital Audio Output.

## Setting Up the Audio Options

### 3 DTS

1. Off : Doesn't output digital signal.
2. On : Outputs DTS Bitstream via digital output only. Select DTS when connecting to a DTS Decoder.

**Note** There is no analog audio output when you play DTS sound disc.

### 4 Dynamic Compression

1. On : To select dynamic compression.
2. Off : To select the standard range.

### 5 PCM Down Sampling

1. On : Select this when the amplifier connected to the player is not 96KHz compatible. In this case, the 96KHz signals will be down converted to 48KHz.
2. Off : Select this when the amplifier connected to the player is 96KHz compatible. In this case, all signals will be output without any changes.

### 6 Speaker Setup (See pages 33-34)

### Note

- **How to make the SETUP menu disappear or return to menu screen during set up;** Press RETURN or LEFT button.
- Manufactured under license from Dolby Laboratories. "Dolby" and the double-D symbol are trademarks of Dolby Laboratories.
- "DTS" and "DTS Digital Out" are trademarks of Digital Theater Systems, Inc.
- DVD-AUDIO
  - Outputs 2 channel digital audio only.
  - Some DVD-AUDIO discs do not downmix, so they will not output 2 channel digital audio.
  - MULTI channel DVD-AUDIO discs play back through the analog outputs.
- SACD
  - Outputs analog signals only.

## Surround Sound Speaker Setup

1. With the unit in Stop mode, press the MENU button.
2. Select **Setup** using UP/DOWN buttons, then press the RIGHT or ENTER button.
3. Select **Audio Setup** using UP/DOWN buttons, then press the RIGHT or ENTER button.

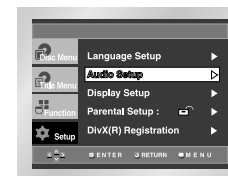

4. Use the UP/DOWN buttons to select **Speaker Setup**. Then press the RIGHT or ENTER button.

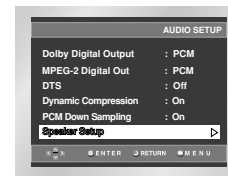

5. Use the UP/DOWN or LEFT/RIGHT buttons to select the desired item. Then press the ENTER button.

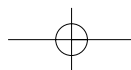

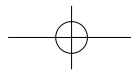

## Surround Sound Speaker Setup

The default settings : FRONT L, R (Small), CENTER (Small), SURROUND (Small).  
Select the size of the speakers to be connected.

### • Front (FL, FR)

- **Large**: Normally select this.
- **Small**: When the sound distorts or the surround sound effects are difficult to hear, select this. This activates the Dolby Digital bass redirection circuitry and outputs the bass frequencies of the speaker from the subwoofer.

### • Center

- **None**: If you do not connect a center speaker, select this.
- **Large**: Normally select this.
- **Small**: When the sound distorts, select this. This activates the Dolby Digital bass redirection circuitry and outputs the bass frequencies of the center speaker from other speakers.

### • Surround (SL, SR)

- **None**: If you do not connect a center speaker, select this.
- **Large (Rear/Side)**: Normally select either of these according to the rear speaker's position.
- **Small (Rear/Side)**: When the sound distorts or the surround sound effects are difficult to hear, select either of these according to the rear speaker's position. This activates the Dolby Digital bass redirection circuitry and outputs the bass frequencies of the rear speaker from other speakers.

## Setting up TEST

The test output signals come clockwise starting from the Front Speaker(L). Adjust Channel Balance to match to the volume of test signals memorized in the system.

FRONT(L) → CENTER → SUBWOOFER →  
FRONT(R) → SURROUND(R) → SURROUND(L)

### Note

How to make the SETUP menu disappear or return to menu screen during set up. Press RETURN or LEFT button.

- The subwoofer test output signal is lower than the other speakers.
- The MPEG Multichannel logo is a trademark registered by PHILIPS Corporation.
- If you set Front (L, R) "Small", LFE(Subwoofer) is set "On" automatically.

## Setting Up the Display Options

1. With the unit in Stop mode, press the MENU button.
2. Select **Setup** using UP/DOWN buttons, then press the RIGHT or ENTER button.
3. Select **Display Setup** using UP/DOWN buttons, then press the RIGHT or ENTER button.



4. Use the UP/DOWN buttons to select the desired item. Then press the RIGHT or ENTER button.

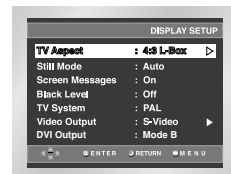

### 1 TV Aspect

Depending on the type of television you have, you may want to adjust the screen setting (aspect ratio).

1. 4:3 Letter Box : Select when you want to see the total 16:9 ratio screen DVD supplies, even though you have a TV with a 4:3 ratio screen. Black bars will appear at the top and bottom of the screen.
2. 4:3 Pan Scan : Select this for conventional size TVs when you want to see the central portion of the 16:9 screen. (Extreme left and right side of movie picture will be cut off.)
3. 16:9 Wide : You can view the full 16:9 picture on your widescreen TV.

## Setting Up the Display Options

### 2 Still Mode

These options will help prevent picture shake in still mode and display small text clearer.

1. Auto : When selecting Auto, Field/Frame mode will be automatically converted.
2. Field : Select this feature when the screen shakes in the Auto mode.
3. Frame : Select this feature when you want to see small letters more clearly in the Auto mode.

### 3 Screen Messages

Use to turn on-screen messages On or Off.

### 4 Black Level

Adjusts the brightness of the screen.(On/Off)

### 6 TV System

1. NTSC Disc : In case of using NTSC disc
  - If your TV system only has PAL-Video input, you must choose "PAL". When you choose "PAL", Interlace output format is PAL 60 Hz output.
  - If your TV system only has NTSC, input you must choose "NTSC Output".
  - If you set up the NTSC TV system, DVI output frame rate is 60 Hz.
2. PAL Disc : In case of using PAL disc
  - If your TV system only has NTSC-Video input, you must choose "NTSC Output".
  - If your TV system only has PAL input, you must choose "PAL Output".
  - If you set up the PAL TV system, DVI output frame rate is 50 Hz.

### 6 Video Output

Select Video Output.

1. S-Video : Select when you want to use Video and S-Video Out.
2. Component (I-SCAN) : Select when you want to use Video and Component 525i(Interlace) Out.
3. Component (P-SCAN) & DVI : Select when you want to use Component 525p(Progressive) Out or DVI.
  - \* If you press the VIDEO SEL. button, Video output mode is changed in regular sequence in NO disc mode.  
(S-Video → I-SCAN → P-SCAN & DVI )

\* If the Yes/No selection in the Display Setup sub Menu is not made within 10 seconds, the screen returns to the previous menu.

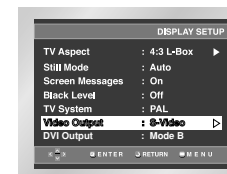

### 7 DVI Output

You can use this function to DVI output format.

- This function corrects a biased TV screen to secure a normal view.
- If DVI Output is set incorrectly, the screen can be biased.

### Important Note

- Consult your TV User's Manual to find out if your TV supports Progressive Scan. If Progressive Scan is supported, follow the TV User's Manual's instructions regarding Progressive Scan settings in the TV's menu system.
- If Video Output is set incorrectly, the screen can be blocked. (See page 40)

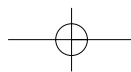
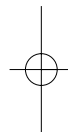

## Setting Up the Parental Control

The Parental Control function works in conjunction with DVDs that have been assigned a rating which helps you control the types of DVDs that your family watches. There are up to 8 rating levels on a disc.

1. With the unit in Stop mode, press the MENU button.
2. Select **Setup** using UP/DOWN buttons, then press the RIGHT or ENTER button.
3. Select **Parental Setup** using UP/DOWN buttons, then press the RIGHT or ENTER button.



4. Use RIGHT or ENTER to select **Yes** if you want to use a password. The **Enter Password** screen appears.

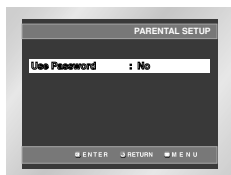

5. Enter your password. The **Re-enter Password** screen appears to confirm the password. Enter your password again. The player is locked (🔒).

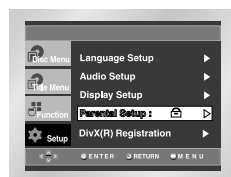
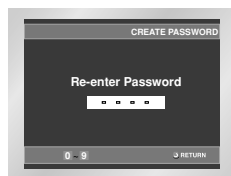
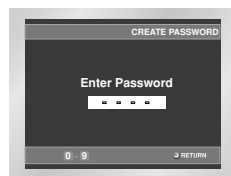

## Setting Up the Parental Control

### Setting Up the Rating Level

1. With the unit in Stop mode, press the MENU button.
2. Select **Setup** using UP/DOWN buttons, then press the RIGHT or ENTER button. The player is locked (🔒).

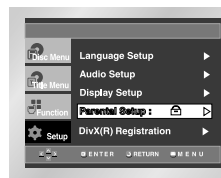

3. Select **Parental Setup** using UP/DOWN buttons, then press the RIGHT or ENTER button.

4. Enter your password. The Parental Setup screen appears.

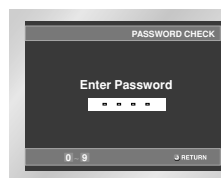

5. Select **Rating Level** using UP/DOWN buttons, and press ENTER or RIGHT button.

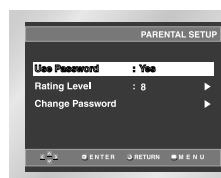

6. Select the Rating Level you want using UP/DOWN buttons.

For example, if you select up to Level 6, discs that contain Level 7, 8 will not play.

- To cancel the Rating Level, select No using RIGHT or ENTER in Use Password.

e.g) Setting up in LEVEL6.

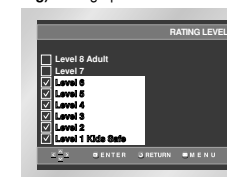

### About the Change Password

- Highlight **Change Password** using UP/DOWN buttons.
- Press ENTER button.
- The **Change Password** screen appears.
- Enter your new password. Enter the new password again.

### Note

- **How to make the SETUP menu disappear or return to menu screen during set up;** Press RETURN or LEFT button.
- If you have forgotten your password, see page 40.

## Controlling a TV with the Remote

The remote can also be set up to control most TVs. To program the remote, use the code that corresponds to your brand.

TV Codes			
BRAND	CODE	BRAND	CODE
ANAM	10, 11, 12, 13, 14, 15, 16, 17, 18	NORDMENDE	72, 73
AIWA	82	NOKIA	74
BANG&OLUFSEN	57	PANASONIC	53, 54, 74, 75
BLAUPUNKT	71	PHILIPS	06, 55, 56, 57
BRANDT	73	PHONOLA	06, 56, 57
BRIONVEGA	57	PIONEER	58, 59, 73, 74, 75
CGE	52	RADIOLA	06, 56
CONTINENTAL EDISON	75	RADIOMARELLI	57
DAEWOO	19, 20, 23, 24, 25, 26, 27, 28, 29, 30, 31, 32, 33, 34	RCA	45, 46
		REX	74
		SABA	57, 72, 73, 74, 75
EMERSON	64	SALORA	74
FERGUSON	73	SAMSUNG	01, 02, 03, 04, 05, 06, 07, 08, 09
FINLUX	06, 49, 57	SANYO	41, 42, 43, 44, 48
FORMENTI	57	SCHNEIDER	06
FUJITSU	84	SELECO	74
GRADIENTE	70	SHARP	36, 37, 38, 39, 48
GRUNDIG	49, 52, 71	SIEMENS	71
HITACHI	60, 72, 73, 75	SINGER	57
IMPERIAL	52	SINUDYNE	57
JVC	61, 79	SONY	35, 48
LG	06, 19, 20, 21, 22, 78	TELEAVA	73
LOEWE	06, 69	TELEFUNKEN	67, 73, 75, 76
LOEWE OPTA	06, 57	THOMSON	72, 73, 75
MAGNAVOX	40	THOMSON ASIA	80, 81
METZ	57	TOSHIBA	47, 48, 49, 50, 51, 52
MITSUBISHI	06, 48, 62, 65	WEGA	57
MIVAR	52, 77	YOKO	06
NEC	83	ZENITH	63
NEWSAN	68		
NOBLEX	66		

- Turn on the TV.
- Point the DVD's remote at the TV.
- While holding the TV POWER button down, enter the code for your brand.
- If the TV turns off, setup is complete. Enter other codes of the same brand if the first code does not work.
- To operate the TV, use the "TV Function Buttons" described on page 8.

### Important Note

- The remote may not be able to control every model TV of the brands listed.
- If you replace the remote control's batteries, set the brand code again.

e.g) For Samsung 2 TVs

While holding down the TV POWER button, enter 0 and then 1.

ENG-38

## Firmware upgrade

### Introduction

Samsung will often support the software upgrade to improve the performance of this unit to the latest status, through Samsung Internet Site ([www.samsung.com](http://www.samsung.com)).

Because the specially new mpeg4 codec continues and it is appearing. What improvements are made depends on the upgrade software you are using as well as the software that your DVD-player contained before the upgrade.

### How to make an upgrade disc

Write the downloaded file onto a blank CD-R or CD-RW disc, using the following settings:

- You have to download a new file through Download Center of Samsung Internet Site ([www.samsung.com](http://www.samsung.com)).
- Write the file to Disc using CD-RW of your computer.

### Note

- File System CD-ROM ISO Level
- Character set ISO 9660
- Finalized, single session
- Write speed low

### Upgrade procedure

- Press OPEN/CLOSE to open the disc tray.
- Insert the upgrade CD-R disc, label facing up.
- Press OPEN/CLOSE to close the disc tray.

### Firmware upgrade appears on the display



- Press the ENTER button.

### Firmware upgrade starts



- In the middle of the writing, the tray will open automatically. After taking out the disc, please wait for about 2 minutes.
- If the unit was successfully updated, the unit will turn off and on after closing the tray automatically. When the unit turns on, this screen will display.





- Select the desired language.

- Note**
- If the "Select Menu Language" doesn't appear, please contact to "Samsung Service Center".
  - Do not press any button and unplug the power code during upgrade.**
  - The upgrade procedure may change, refer to the web site ([www.samsung.com](http://www.samsung.com)).**

ENG-39

## Troubleshooting

Before requesting service (troubleshooting), please check the following.

Problem	Action	Page
No operations can be performed with the remote.	<ul style="list-style-type: none"> <li>Check the batteries in the remote. They may need replacing.</li> <li>Operate the remote control at a distance of no more than 20 feet.</li> <li>Remove batteries and hold down one or more buttons for several minutes to drain the microprocessor inside the remote to reset it. Reinstall batteries and try to operate the remote again.</li> </ul>	P3
Disc does not play.	<ul style="list-style-type: none"> <li>Ensure that the disc is installed with the label side facing up.</li> <li>Check the region number of the DVD.</li> </ul>	P5
5.1 channel sound is not being reproduced.	<ul style="list-style-type: none"> <li>5.1 channel sound is reproduced only when the following conditions are met. :               <ol style="list-style-type: none"> <li>The DVD player is connected with the proper amplifier</li> <li>The disc is recorded with 5.1 channel sound.</li> </ol> </li> <li>Check whether the disc being played has the "Dolby 5.1 ch" mark on the outside.</li> <li>Check if your audio system is connected and working properly.</li> <li>In a SETUP Menu, is the Audio Output set to Bitstream?</li> </ul>	P9 P32
The  icon appears on screen.	<ul style="list-style-type: none"> <li>The features or action cannot be completed at this time because:               <ol style="list-style-type: none"> <li>The DVD's software restricts it.</li> <li>The DVD's software doesn't support the feature (e.g., angles).</li> <li>The feature is not available at the moment.</li> <li>You've requested a title or chapter number or search time that is out of range.</li> </ol> </li> </ul>	P13
Disc Menu doesn't appear.	<ul style="list-style-type: none"> <li>Check if the disc has a Menu.</li> </ul>	
Play mode differs from the Setup Menu selection.	<ul style="list-style-type: none"> <li>Some of the functions selected in the Setup Menu may not work properly if the disc is not encoded with the corresponding function.</li> </ul>	P30~37
The screen ratio cannot be changed.	<ul style="list-style-type: none"> <li>The Screen Ratio is fixed on your DVDs.</li> </ul>	P34~35
No audio.	<ul style="list-style-type: none"> <li>Make sure you have selected the correct Digital Output in the Audio Options Menu.</li> </ul>	P32~34
The screen is blocked	<ul style="list-style-type: none"> <li>Press power on from a cold start with no disc in the unit. Press the  button on the front panel for 5 seconds. The SELECT MENU LANGUAGE display will appear. Select the number button of the desired language.</li> </ul>	P34~35
Forgot password	<ul style="list-style-type: none"> <li>Press power on from a cold start with no disc in the unit. Press the  button on the front panel for 5 seconds. The SELECT MENU LANGUAGE display will appear. Select the number button of the desired language. Press the MENU button, and then press DOWN button to select Setup, then press RIGHT or ENTER. Press Up or Down to select Parental Setup The Parental Setup is now unlocked as indicated on the display. You can change your password.</li> </ul>	P36~37
If you experience other problems.	<ul style="list-style-type: none"> <li>Go to the contents and find the section of the instruction book that contains the explanations regarding the current problem, and follow the procedure once again.</li> <li>If the problem still cannot be solved, please contact your nearest authorized service center.</li> </ul>	

## Troubleshooting

Problem	Action	Page
No DVI output.	<ul style="list-style-type: none"> <li>Check the Video output is DVI enabled.</li> <li>Check the connection between the TV and the DVI jack of DVD player.</li> <li>See if the TV supports this 480p/576p/720p/768p/1080i DVD player.</li> </ul>	P11~12
Abnormal DVI output screen.	<ul style="list-style-type: none"> <li>If snow noise appears on the screen, it means that TV does not support HDCP (High-bandwidth Digital Content Protection).</li> </ul>	P12
DVI output Judder	<ul style="list-style-type: none"> <li>Check your TV system set up correctly.</li> <li>The screen judder phenomenon may occur when frame rate is converted from 50Hz to 60Hz or 60Hz to 50Hz.</li> <li>Refer to your TV users manual.</li> </ul>	P35

## Specifications

General	Power Requirements	AC 110-240 V, 50/60 Hz
	Power Consumption	14 W
	Weight	1.9 Kg
	Dimensions	430mm (W) X 207mm (D) X 50mm (H)
	Operating Temperature Range	+5°C to +35°C
	Operating Humidity Range	10 % to 75 %
Disc	DVD (DIGITAL VERSATILE DISC)	Reading Speed : 3.49 ~ 4.06 m/sec. Approx. Play Time (Single Sided, Single Layer Disc) : 135 min.
	CD : 12Cm (COMPACT DISC)	Reading Speed : 4.8 ~ 5.6 m/sec. Maximum Play Time : 74 min.
	CD : 8Cm (COMPACT DISC)	Reading Speed : 4.8 ~ 5.6 m/sec. Maximum Play Time : 20 min.
	VCD : 12Cm	Reading Speed : 4.8 ~ 5.6 m/sec. Maximum Play Time : 74 min. (Video + Audio)
Video Output	Composite Video	1 channel : 1.0 Vp-p (75 Ω load)
	Component Video	Y : 1.0 Vp-p (75 Ω load) Pr : 0.70 Vp-p (75 Ω load) Pb : 0.70 Vp-p (75 Ω load)
		Luminance Signal : 1.0 Vp-p (75 Ω load) Chrominance Signal : 0.3 Vp-p (75 Ω load)
	DVI	Digital Visual Interface
Audio Output	2 Channel	L(1/L), R(2/R)
	5.1 Channel	F/L, F/R, R/L, R/R, C/T, S/W
	*Frequency Response	48 kHz Sampling : 4 Hz to 22 kHz 96 kHz Sampling : 4 Hz to 44 kHz
	*S/N Ratio	110 dB
	*Dynamic Range	100 dB
	*Total Harmonic Distortion	0.004 %

\*: Nominal specification

- Samsung Electronics Co., Ltd reserves the right to change the specifications without notice.
- Weight and dimensions are approximate.