

# ÖKO\_FAVORIT 5450 VI

Dishwasher

Operating Instructions

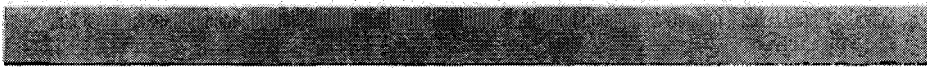

# Contents

<b>Safety instructions</b>	4
<b>Disposing of packaging and old machine</b>	6
Disposing of the packaging	6
Disposing of your old machine	6
<b>Important hints</b>	7
Operating your dishwasher economically and with regard for the environment	7
<b>Description of the appliance</b>	8
The inside of the appliance	8
<b>Use</b>	9
Control panel	9
<b>Dish-washing programmes</b>	10
Before using your dishwasher for the first time	12
Setting the water hardness range	12
Filling with special salt	14
Salt refill indicator	15
The rinse-aid	15
Setting the rinse-aid quantity to be added	16
Adding dishwashing detergent	16
BIO programmes and compact powders	18
<b>Loading your machine</b>	19
The lower basket	19
Cutlery basket	20
The upper basket	21
<b>Operating instructions</b>	23
<b>Care instructions</b>	25
Cleaning the filter group	25
<b>Servicing</b>	27
<b>Customer service</b>	29
<b>Technical data</b>	30
<b>Installing</b>	31
Positioning	31
Connecting the water supply	31
Water Outlet Connection	32
Electrical connection	34

## Safety instructions

The safety of AEG electrical appliances conforms to accepted rules of technology and the Appliance Safety Act. We as manufacturers, however, see ourselves as being obliged to familiarize you with the following safety instructions.

### Using your dishwasher for its intended purpose

- Only use your dishwasher for machine washing of household crockery. If your machine is misused or used for any purposes other than that for which it is intended, the manufacturer cannot be held liable for any damage caused.
- For safety reasons, you should not convert or modify your dishwasher in any way.

### Before using your dishwasher for the first time

- Check your dishwasher for any transport damage. Never connect a damaged machine. If your dishwasher is damaged, you should contact your supplier.
- Your dishwasher must be correctly installed and connected. Please read the section on "Installation" to make sure you know all about this.
- Before using your dishwasher for the first time, do not forget that the nominal voltage and current type indicated on the rating plate of your machine must be the same as the nominal voltage and current type at the installation site. The necessary electrical fusing is also given on the rating plate.

### Child safety

- Packaging parts (e.g. foils, styrene foam) may be dangerous for children, who could even be suffocated! You should therefore keep all packaging well away from children.
- Children may not recognize the dangers of improper use of electrical appliances. You should therefore ensure proper supervision during operation and not allow your children to play with your dishwasher.
- Detergents may have a caustic effect on eyes, mouth and throat and may even cause suffocation! Keep all detergents in a safe place out of children's reach.
- The water in your dishwasher should not be used for drinking. Detergent residues may still be present in your machine. Make sure you do not splash these caustic residues onto your skin or suffocate yourself! Keep children well away from your dishwasher when its door is open.

## **Your dishwasher in day-to-day use**

- Never operate your dishwasher if the electrical supply lead, supply or drain hose, control panel, worktop or plinth are damaged.
- If there is a fault, first turn the water tap off. Then switch off your machine and pull the plug out of the socket. If there is a fixed connection, switch off or unscrew the fuse(s).
- Never pull the plug out of the socket by the cable - always hold the plug.
- Dishwasher repairs should only be performed by trained personnel. Improper repairs may seriously endanger the user. If your dishwasher needs to be repaired, you should contact our service centre or your retailer.
- Never place any solvents in your dishwasher or you may cause an explosion!
- Do not rest or sit on the open door or the machine could tilt.
- Before using special dishwasher salt, detergent or rinse-aid, make sure that the manufacturer of these products expressly specifies their use in domestic dishwashers.
- Always turn off the water tap when your dishwasher is left unattended for any length of time, e.g. when you are away on holiday.
- Only transport the dishwasher in an upright position. Tipping it upside down during transport could cause salty water to leak into the internal compartment and lead to the formation of rust.

## Disposing of packaging and old machine

### Disposing of the packaging

Our dishwashers require effective protective packaging in transit, though we always confine ourselves to what is absolutely necessary.



**Warning!** Packaging parts (e.g. foils, styrene foam) may be dangerous for children, who could even be suffocated! You should therefore keep all packaging well away from children.

All packaging materials used are environmentally compatible and reusable. The cardboard parts are produced from recycled paper, and the wood is untreated.

The plastics are marked as follows:

>PE< for polyethylene. e.g. packaging foils

>PS< for polystyrene. e.g. padding (essentially CFC-Free)

>POM< for polyoxymethylene, e.g. plastic clamps.

By recycling and reuse of the packaging, raw materials can be saved and the volume of refuse reduced.

Give the packaging for reuse to your local recycling centre. Your municipal or local authority will give you its address.

### Disposing of your old machine

When your machine finally reaches the end of its life and you withdraw it from service, you should render it unserviceable before having it disposed of.



**Warning!** Children at play could lock themselves in your machine (and suffocate) or otherwise endanger their lives. Therefore pull out the mains plug and detach and discard the electrical supply lead. Disable the door lock so that the door no longer closes.

Marking of plastic parts for graded recycling: All plastic parts in your machine are marked with internationally standardized abbreviations (e.g. >PS< for polystyrene). When your machine is disposed of, this enables plastic waste to be sorted into individual types for environmentally conscious recycling.

Take your decommissioned machine to your local recycling centre or dealer, who will take it back from you for a small handling charge.

## Important hints

### **Operating your dishwasher economically and with regard for the environment**

Collect your dirty dishes, stack them in the dishwasher, and only wash them when both baskets are full, making sure that the latter are never overloaded. Only then can you be sure that you are machine-washing economically and with regard for the environment.

Always select the programme corresponding to the type of crockery and degree of soiling (see "Programme chart").

Never overdose detergents, special salt or rinse-aid. Follow the dosage recommendations in these operating instructions as well as the instructions given by manufacturers of these products.

Make sure that the water softener is correctly set.

### **Unsuitable crockery**

The following are unsuitable for machine washing:

- wooden boards or platters
- non-heat-resistant plastic parts
- lead crystal glass
- tin or copper items
- glued crockery or cutlery
- older types of cutlery with temperature-sensitive adhesive
- steel knives that are liable to rust
- cutlery with wood, horn, porcelain or mother-of-pearl handles.

### **Suitable crockery**

The following items have certain machine washing limitations:

- Only wash earthenware crockery in your dishwasher if the manufacturer has expressly indicated it as being suitable for that purpose.
- Some types of decoration which have been painted over the glaze may fade after frequent machine washing.
- Silver and aluminium parts tend to discolour during machine washing.
- Many food residues, such as egg white, egg yolk and mustard often cause discoloration or staining on silver. Silver crockery and cutlery should therefore always be cleaned of food residues if they are not washed immediately after a meal.
- Some types of glass may become cloudy after many washing cycles. You should therefore continue to hand-wash especially valuable glass-ware.

When buying new crockery and cutlery, confirm that they are dishwasher-safe.

# Description of the appliance

## The inside of the appliance

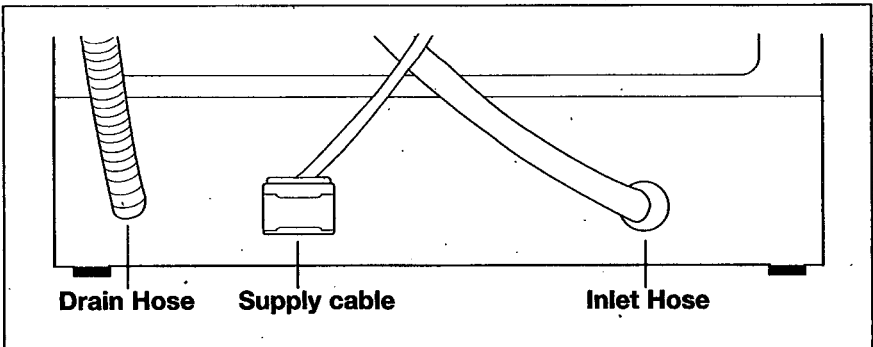
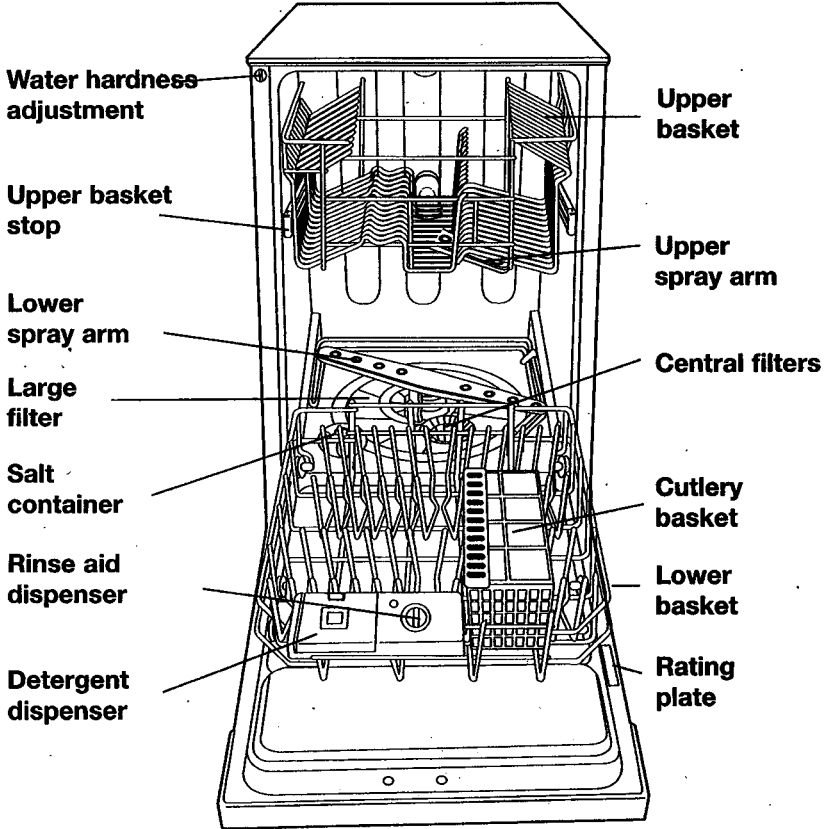



# Use

## Control panel

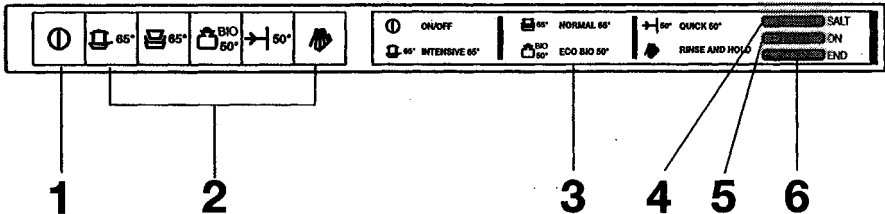

In this fully integrated appliance the controls are located on top of the door. When selecting a programme, the door needs to be partially opened.

### 1. ON/OFF Pushbutton

By depressing this pushbutton the mains-on **ON** (5) and the end of programme **END** (6) indicator lights illuminate indicating that the washing programme can be selected and started.

### 2. Programme Selector Buttons

Depress the button corresponding to the desired washing programme (see the washing programme chart).

### 3. Programme Guide

This is a summary of the washing programme chart to help you to select the correct programme. Three interchangeable programme charts are supplied extract the one mounted on the control panel and insert the English version.

### 4. Salt Refill Indicator Light **SALT**

This light illuminates when the salt container needs refilling. This light will remain on in a soft water area where salt is not required.















### 5. Mains-On Pilot Light **ON**

This illuminates when the ON/OFF button  (1) is depressed, indicating that the machine is on.

### 6. End of Programme Indicator Light **END**

This light illuminates when the programme has finished.

## Dish-washing programmes

Programmes	Quantity of food scraps Type of soil	Type of load	Required pushbuttons	
<b>INTENSIVE</b> 65°  65°	Heavily soiled, also dried up and containing starch (i.e. pasta, rice, semolina, potatoes, egg, sauces, roast).		  65°	
<b>NORMAL</b> 65°  65°	Normally to heavily soiled, also dried up and/or containing starch (i.e. pasta, rice, semolina, potatoes, egg, sauces, roast).		Pots - Pans Crockery	  65°
<b>ECO BIO</b> 50°  BIO 50°	Normally to lightly soiled, not dried up and starchless (i.e. no burnt-on meat residues, boiled or raw vegetables, milk, coffee, drinks).			  BIO 50°
<b>* QUICK WASH 50°</b>  50°	Lightly soiled, not dried up and starchless (i.e. drinks, cakes and pastry, salad, sliced ham, cheese).	Crockery Party crockery	  50°	
<b>RINSE AND HOLD</b> 	Partial load to be completed later. This programme does not require any detergent.		 	

### Testing programme according to IEC 436/DIN 44990:

- NORMAL 65°C programme with standard detergent type A and ECO BIO 50°C programme with standard detergent type B;
- Standard place settings: 8 (see Figs. 9 and 12);
- Recommended quantity of detergent: 15 g in the dispenser  
5 g on the dispenser lid.

\* This is a special programme for quick washing (approx. 36 minutes) a full load of lightly soiled dishes, glasses and crockery (except pots) so that you may re-use them promptly. Due to the shortness of this programme, no drying phase is provided.

Recommended quantity of detergent **		Cycle description	Approximate consumption values ***			
inside the dispenser	on the dispenser lid		Programme duration in minutes ****		Energy consumption in kWh	Water consumption in litres
			1	2		
1 heaped dessert spoonful (15 g)	1 level dessert spoonful (10 g)	Prewash up to 55°C Main wash up to 65°C 2 cold rinses 1 hot rinse up to 65°C Hot air drying	88	74	1.5	22
1 heaped dessert spoonful (15 g)	Half dessert spoonful (5 g)	Cold prewash Main wash up to 65°C 1 cold rinse 1 hot rinse up to 65°C Hot air drying	76	64	1.1	17
1 heaped dessert spoonful (15 g)	Half dessert spoonful (5 g)	Cold prewash Main wash up to 50°C 1 cold rinse 1 hot rinse up to 65°C Hot air drying	76	64	1.0	17
1 level dessert spoonful (10 g)	/	Main wash up to 50°C 1 cold rinse 1 hot rinse up to 55°C	42	36	0.8	16
/	/	1 cold rinse (to avoid food scraps from sticking to the dishes).	10	10	0.1	11

\*\* As some products can be more efficient than others, please also pay particular attention to the dosage instructions from the manufacturer of your brand.

If you use the modern "compact" powders containing enzymes, we recommend as a fundamental rule that you select the 50°C programme as the enzymes function at their most effectiveness at or around this temperature.

\*\*\* These specifications are indicative values and depend on the pressure and temperature of the water, and also on voltage modifications.

\*\*\*\* The duration of the programme depends on the total power absorbed. This value can be found on the rating plate on the right hand side of the door. In this way you will easily discover the column of the programme duration-relating to your appliance.

Column 1 = 230V / 2100W / 10A

Column 2 = 230V / 3000W / 16A

220-240V / 2770W / 13A

## Before using your dishwasher for the first time

When your new dishwasher is correctly set up and installed, you must first make it ready for use.

Before using your dishwasher for the first time, proceed as follows:

- set the water softener;
- fill the special salt container with special salt;
- fill the rinse-aid dispenser with rinse-aid.

The following sections give you more detailed information about the individual points.

## Setting the water hardness range

Soft (low-lime) water is necessary for machine washing to avoid lime deposits on crockery and in your dishwasher. Tap water with a hardness above 4°d (German degree) must therefore be softened for machine washing.

For this purpose, your dishwasher is fitted with a water softener. The water softener is treated (regenerated) automatically and at regular intervals with salt solution. The salt consumption needed for regeneration thus depends on the local water hardness. Your local water company will provide you with information about water hardness in your area.

To ensure optimum regeneration of the water softener:

- the water softening system must be set to the local water hardness;
- the dishwasher salt container must always be filled with special salt.

Your local Water Company will provide you with information about water hardness in your area.

To ensure minimum salt consumption with optimum washing results, your dishwasher is fitted with a hardness range setting with five possible stages.

Level	Water hardness		Use of salt	Water softener adjust-	Adjustment on the machine
	°dH German degrees	°TH French degrees			
1	0-7	0-14	**NO	-	1
*2	8-21	15-39	YES	-	1
3	22-28	40-50	YES	+	1
4	29-39	51-70	YES	-	2
5	40-50	71-90	YES	+	2

\* The water softener is factory set at level 2 as this suits most users.

\*\* If you use phosphate free detergents containing enzymes, add salt starting from 4°dH (7°TH).

For economic operation and as a contribution to environmental protection, no more salt should be used than is necessary. For this reason, set the level of water hardness which is correct for the water in your area.

### Level 1

If your water is Level 1 it is already soft and therefore there is no need to use salt. In this case do not take into account the salt light on the control panel, which illuminates when there is no salt inside the salt container.

### Level 2

If your water hardness is Level 2, only regenerating salt will be necessary. It is not necessary to set the water hardness level on the machine.

### Levels 3 and 5 (water softener adjustment)

If your water is Level 3 or 5, proceed as follows:

slide out the lower basket and unscrew the cap of the salt container; turn the two-position selector anticlockwise from position - to position + with the aid of a knife or a screwdriver.

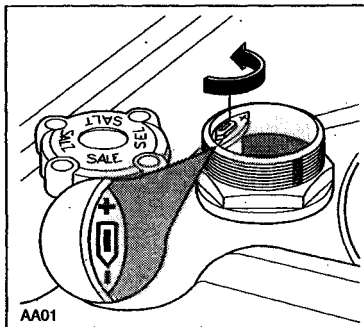

Fig. 1

### Levels 4 and 5 (adjustment on the machine)

If your water is Level 4 or 5, open the door and turn the selector on the upper left-hand corner of the machine from position 1 to position 2.

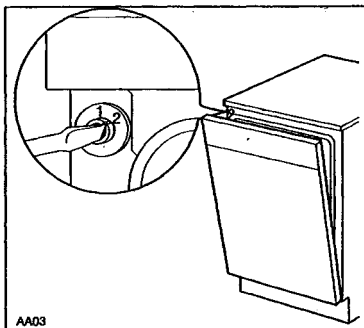

Fig. 2

With a water hardness of level 5 both adjustments must be made.

**Note:** From Level 2 upwards, regenerating salt is to be used regularly. The relevant instructions are contained in the next section.

### Filling with special salt

Only use salt designed specifically for use in dishwashers. Other types of salt i.e. table/cooking salt contain high percentages of other substances which may reduce the efficiency of the softener.

**Caution!** The packaging of dishwasher salt and detergents are often very similar. The accidental filling of the salt compartment with detergent would ruin the water softener. Each time you add salt, make sure the carton you have in your hand really is salt.

To fill with salt, unscrew the cap of the salt container. Pour about half a litre of water into the container, or until it is full (this is only necessary before filling with salt for the first time).

Pour inside the container about 1 kg of regenerating salt.

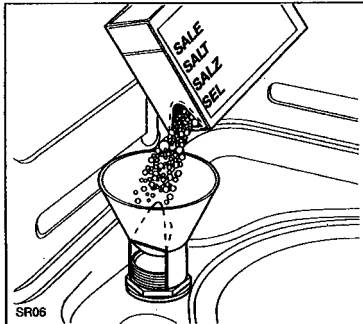

**Fig. 3**

Clean any excess salt from the screw thread and the washer and carefully close the cap.

**Caution:** Only fill with salt just before starting one of the complete washing programmes (not the PREWASH programme). This will prevent any grains of salt or salty water, which may have been spilled, remaining on the bottom of the machine for any period of time, which could cause corrosion.

## Salt refill indicator

You must refill the salt container with special salt when the salt refill indicator light **SALT** on the control panel illuminates. Depending on the grain size of the salt, it may be some hours before the light goes out again.

### Important:

At water hardness below 4°d, you need not fill your dishwasher with special salt. In this case, the control panel continuously shows the illuminated salt refill indicator light **SALT**. This implies no loss of machine function.

## The rinse-aid

The rinse-aid ensures brilliant crockery and also helps it to dry. It is automatically dosed in during the hot rinsing cycle. The storage compartment built in to the inside of the door can hold about 110 ml of rinse-aid, which will be sufficient for between 16 and 40 dish-washing programmes, according to the dosage setting.

### Filling up the rinse-aid

Open the container by turning the lid (A) anticlockwise (Fig. 4). Pour the rinse-aid into the filler opening until the indicator (B) on the side of the cover turns completely dark (i.e. until the container is full)

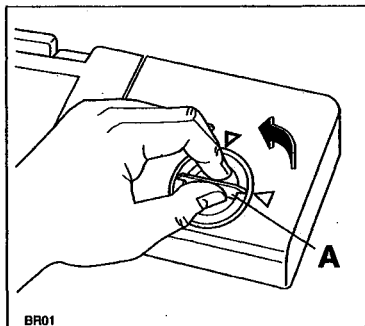

Fig 4

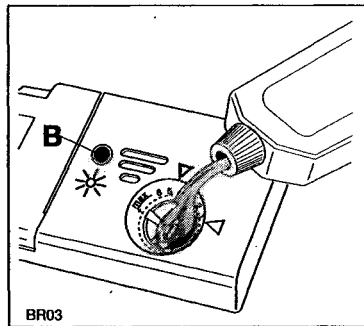

Fig. 5

### Tighten firmly the cover.

Clean up any rinse aid spilt during filling with an absorbent cloth to avoid excess foaming during the next wash.

### Rinse-aid replenishment indicator

You must top up again with rinse-aid when the display window on the rinse-aid dispenser (Fig. 5) shows a dark spot surrounded by a bright ring. When the rinse-aid dispenser is full, the indicator (B) on the rinse aid dispenser (Fig. 5) appears uniformly dark (after about 70-80 ml).

## Setting the rinse-aid quantity to be added

The correct dosage of the rinse-aid should be regulated on the basis of the shine and drying results. For this purpose, set the quantity of liquid by means of the six-position selector (C) located on the inside of the filler opening (minimum quantity is position 1, maximum quantity is position 6). Use the tip of a knife or a screwdriver to rotate the selector. If drops of water or white marks remain on the crockery after it has been washed, gradually increase the dosage. If the crockery comes out with whitish, sticky streaks, reduce the dosage.

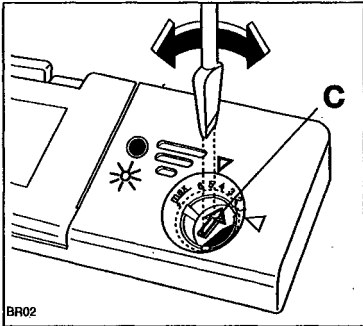

Fig. 6

## Adding dishwashing detergent

**Use only tablets, powder or liquid detergents specifically designed for domestic dishwashers.**

Before starting any of the dishwashing programmes, except for the rinse and hold programme, load the detergent in the dispenser.

To open the dispenser lid, pull the catch (D). This will open it.

To help you to correctly dose the right amount of detergent, inside the container there are two reference marks:

- MIN = 15 ml - MAX = 30 ml

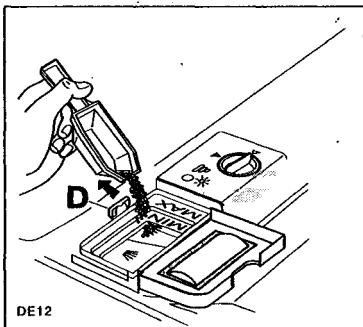

Fig. 7



The amount of detergent to be used varies depending on how soiled the dishes are and the type of dishes being washed. We recommend the amounts shown in the programme chart.

**After filling the dispenser with detergent, close the lid.**

All the programmes with prewash require a small extra amount of detergent of approximately 5 g = a coffee spoon to be poured over the lid of the dispenser, as shown on the picture.

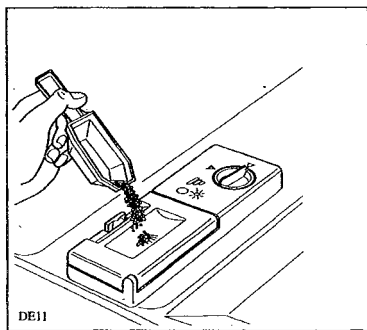

**Fig. 8**

Use double this amount (10 g) if selecting the Intensive Programme. At the end of any washing programme the lid is always open, ready for the next wash.

Since not all detergents are the same, you should also consult the instructions on the packet.

Remember that insufficient quantities of detergent will produce poor washing results whereas an excessive amount of detergent does not improve washing results and is also wasteful.

Using no more than the correct amount of detergent also contributes to reducing pollution.

## **BIO programmes and compact powders**

On the basis of their chemical composition, dishwasher detergents can be classified into two basic groups:

- conventional, alkaline detergents with caustic components:
- low-alkaline compact powders with natural enzymes.

The enzymes in low-alkaline compact powders have a dirt-dissolving effect and are also biodegradable. These enzymes deploy their full dirt-dissolving power within a temperature range of 40-50°C. In BIO washing programmes, the temperature range and duration of the heating phases are precisely matched to the dirt-dissolving properties of the enzymes.

In combination with low-alkaline compact powders, BIO washing programmes, at a temperature as low as 50°C, therefore achieve the same cleaning results that would otherwise be achievable only with 65°C programmes.

The lack of any caustic components in low-alkaline compact powders and the lower cleaning temperature of BIO washing programmes not only relieve the environment, but also care for your crockery.

## Loading your machine

Before placing dishes in the machine, remove any large scraps of food from the plates (small bones, toothpicks, fish bones, scraps of meat and vegetables, fruit skins etc.) to avoid clogging the filters and consequently reducing performance.

Open the door and slide out the baskets to load the dishes.

Before loading, remove all scraps of food and soak very heavily soiled pots and pans.

Always arrange saucepans, cups and glasses etc. upside-down.

Tilt items with convex or concave surfaces so that the water drains off easily.

Long items of cutlery such as ladles, carving knives etc. should be positioned horizontally in the upper basket.

Avoid contact between the dishes as far as possible; correct arrangement of the items will give better washing results.

Light items (plastic bowls etc.) should be loaded in the upper basket and arranged so that they do not move during washing.

### The lower basket

The lower basket is designed to take saucepans, lids, plates (up to 27 cm in diameter), salad bowls, cutlery etc.

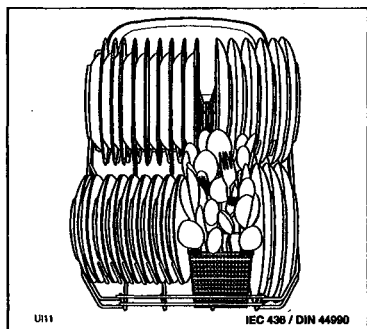

Fig.9

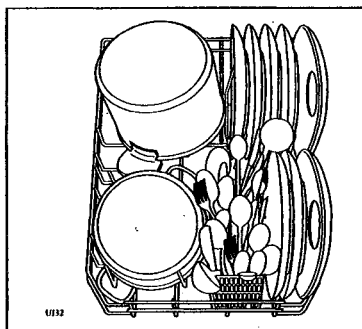

Fig.10

Serving dishes and large lids should be arranged around the edge of the basket, ensuring that the upper spray arm can turn freely.

## Cutlery basket

Cutlery should be placed in the removable cutlery basket with the handles facing downwards. If the handles protrude from the bottom of the basket, obstructing the lower spray arm, load the cutlery with the handles facing upward.

For better cleaning results, we recommend that spoons should be intermingled with other cutlery items so that they do not nestle into one another.

Arrange the spoons, dessert spoons, knives and other small items of cutlery in the rack on one side of the cutlery basket.

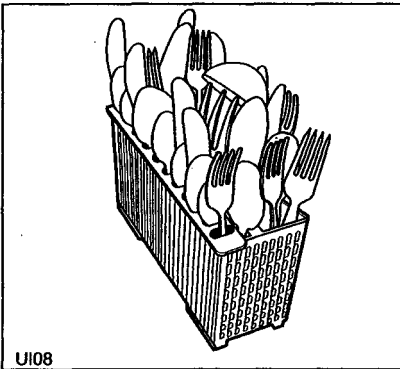

**Fig. 11**

## The upper basket

The upper basket is designed for plates (dessert plates, saucers, dinner plates up to 24 cm in diameter), salad bowls, cups and glasses; these should be arranged as shown in the pictures.

Glasses with long stems can be placed upside-down in the raised cup-racks

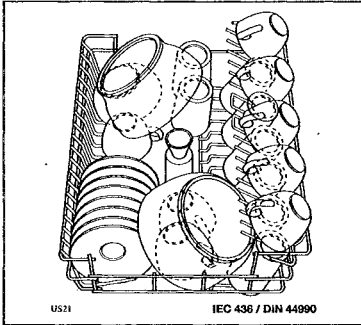

Fig.12

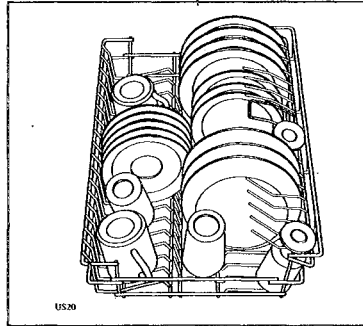

Fig.13

### Caution

When loading the dishes, ensure that you do not cover the water inlet funnel in the middle of the upper basket.

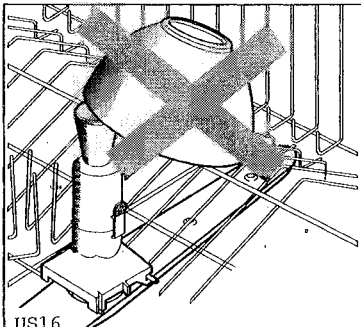

Fig. 14

**Before closing the door, ensure that the spray arms can rotate freely.**

## Adjusting the height of the upper basket

If washing very large plates (over 27 cm and up to 31 cm in diameter) you can load them in the lower basket after moving the upper basket to the higher position as follows:

Move the front runner stops (A) of the upper basket outward and slide the basket out (Fig. 15).

Refit the basket in the higher position and replace the stops (A) in their original position.

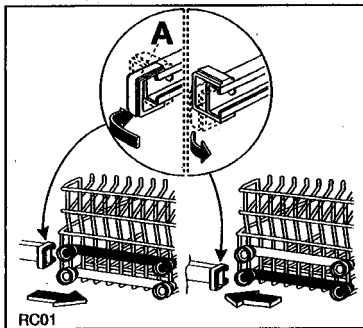

**Fig.15**

When the top basket is in the higher position it will only take plates up to 20 cm in diameter and you will not be able to use the raised cup racks.

# Operating instructions

## Set the programme

The selection of a programme occurs with the door partially opened.

Depress ON/OFF Pushbutton ; the mains-on **ON** and end of programme **END** indicator lights come on.

**Attention:** should the **END** indicator light not come on, it means that the previously selected programme hasn't finished. In this case, wait until the programme is over or cancel the programme (see "To cancel the wash programme").

Depress the programme button which corresponds to the washing programme you wish to select and keep it pressed, until the End indicator light **END** goes out.

## Start the programme

Open the water supply.

Close the door; the dishwasher starts operating.

## At the end of the washing programme

An audible signal will sound for about 2 secs. This is to tell you that the programme is finished.

### Wait until the end of the signal before opening the door.

Open the door. The mains-on **ON** and end-of programme **END** indicator lights are on.

Depress the ON/OFF Button  to switch the dishwasher off.

Turn off the water tap and switch the machine off at the plug.

**Wait a few minutes before removing the dishes; in this way they will be cooler and drying will be improved.**

Empty the lower basket first and then the upper one; this will avoid water dripping from the upper basket onto the dishes in the lower one.

## To cancel the wash programme

To cancel a wash programme in progress or to reset the dishwasher if a wrong one has been selected, proceed as follows:

Check that the appliance is on (ON/OFF Pushbutton  depressed).

Simultaneously depress the **QUICK WASH**  **50°** and **RINSE AND HOLD**  programme buttons.

Close the door. After a few mins you will hear the acoustic signal. This is to tell you that the dishwasher is reset.

**Before opening the door and selecting a new programme wait until the end of the signal (2 secs).**

### Caution

In general it is not advisable to open the door while the machine is working; if the door is opened however, a safety device ensures that the machine stops.

### Interrupting a programme

**Caution!** Opening the door could let very hot steam escape: you risk being scalded! Open the door with great care.

- A programme underway is interrupted when you open the door.
- Close the door again. The programme will start again at the point it was interrupted.



# Care instructions

## Internal and external cleaning

Clean the screen and controls of your dishwasher where necessary with a soft cloth and lukewarm water.

**Important note!** Never use commercially available furniture cleaners or aggressive detergents.

## Cleaning the filter group

Regularly check the cleanliness of the filters which are located at the bottom of the internal compartment and, if necessary, clean them.

Blocked filters will compromise the washing results.

The filter system is composed of three parts (an outer filter (B - fig. 16), a smaller filter (C - fig. 16) and a large filter (A - fig. 17)).

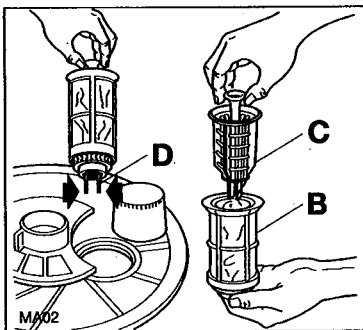

Fig. 16

Lift and remove the outer filter and the smaller filter.

Pressing the two tabs (D - fig. 16) allows the smaller filter (C - fig. 16) to be removed from the outer one (B - fig. 16).

To remove the large filter, first remove the lower rotating arm by pressing the two tabs (E - fig. 17), then turn the locking nut (F - fig. 17) anticlockwise and remove the entire system.

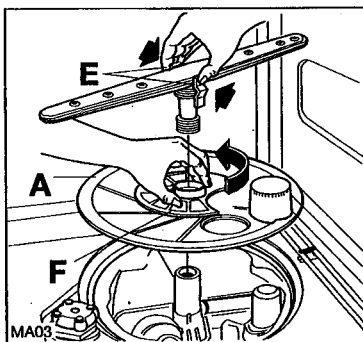
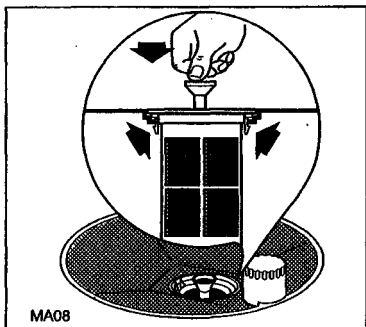

Fig. 17

After cleaning the filters, reassemble the components by proceeding in the reverse order.

Clean the filters under running tap water.

After cleaning them, insert the filters in the dishwasher by pressing them in until they click (Fig. 18).



**Fig. 18**

**Caution:**

**The dishwasher must not be used without filters.**

**Incorrect repositioning of the filters will produce poor washing results.**

**Cleaning of the filters is vital to ensure correct operation of the machine.**

## Servicing

Before calling our service centre, please check whether you can rectify the fault yourself by following the instructions given below. Should this information be of no assistance to you in a specific case, please contact our service centre.

■ The programme will not start

- Are the fuses in the fixed wiring in order? Is your machine connected to the electricity supply?
- Have you closed the door properly? Press the door shut.

■ No water flows in.

- Have you turned on the water tap?
- Is the strainer in the hose screw connection on the water tap choked? Check hose running. Clean the strainer if necessary.
- Is the water supply hose kinked? Check hose running (see the section on "Water drainage"). Is the minimum water pressure of 0,5 bar available? (see the section on "Water supply").

■ The crockery is not clean.

- Have you selected a programme that is suitable for the type and degree of soiling of your crockery? (see the "Programme chart" section).
- Have you arranged the crockery so that the sprayed water has access to all surfaces, both internal and external? The crockery baskets must not be overfilled.
- Have the spray arms been obstructed by crockery or cutlery? Please note that, for better drainage of residual water at the programme end, the upper spray arm obliquely tilts when it comes to rest. When operational, it automatically runs in the horizontal position.
- Are all strainers at the bottom of your dishwasher clean? Are the strainers inserted properly (see the section on "Cleaning the strainers").
- Have you used sufficient detergent? (see the section on "Filling with detergent"). Is the drain hose correctly run? (see the section on "Water drainage").
- Is there still salt in the salt container? Without special salt, the water will not be softened. At water hardnesses above 4°d, lime deposits will form on your dishes (see the section on "Filling with special dishwasher salt").
- Have you set the water softener to the local water hardness? (see the section on "Setting the water softening system").

■ The dishes do not dry and have no sparkle.

- Have you used a brand-named rinse-aid?
- Is there sufficient rinse-aid in the dispenser? (see the section on "Filling with rinse-aid").

■ Glasses and dishes have streaks, stripes, milky blotches, or blue-coloured blooms.

- The rinse-aid is being overdosed. Set a lower rinse-aid dosage (see the section on "Setting the rinse-aid quantity to be dosed").

■ Glasses and dishes have dried-on water drops.

- The rinse-aid is being underdosed. Set a higher rinse-aid dosage (see the section on "Setting the rinse-aid quantity to be dosed").

■ Rust marks can be seen inside your machine.

- The dishwasher interior is made of stainless steel. If rust is found inside your dishwasher, this must be from another source (rust in water, from saucepans, cutlery, etc.). Remove such marks with a commercially available stainless steel cleaner.

- Have you dosed the detergent correctly? (see the section on "Filling with detergent").

- Is there sufficient salt in the salt container? (see the section on "Filling with special dishwasher salt").

- Have you set the water softener correctly? (see the section on "Setting the water softening system").

■ The machine is noisy

- The dishes are settling against each other.

- The spray arms are knocking against the dishes.

■ The door is difficult to close

- The dishwasher is not level or is not properly built-in .

## Customer service

In the section on "If you think your dishwasher is not working properly", we have listed the most important faults which you can rectify yourself. Should you still wish to call our service centre for any of the specified faults or because the appliance is being wrongly operated, the service engineer's visit cannot be made free of charge even during the guarantee period.

Should you find no reference to a fault in the operating instructions, you should call our service centre.

When making your call, quote the E-No. (product number) and F-No. (serial number) indicated on the rating plate. It is located on the RH inside edge of the door.

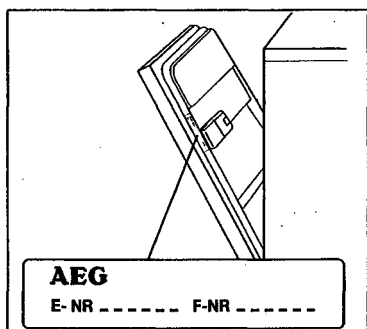

**Fig. 19**

To keep these numbers handy, we recommend you enter them here.

E-No .....

F-No .....

Your specifying these details enables the service centre to make precise identification of the spare part required so that the appliance can be repaired at the service engineer's first visit without your having to pay extra costs for repeated journeys by the service engineer.

## Technical data

### Capacity

8 standard place settings including serving utensils.

### Allowable water pressure

5-80 N/cm<sup>2</sup> (0,5-8 Bar = 0,05-0,8 MPa).

### Electrical connection

Details of the electrical connection are given on the rating plate. It is located on the RH inside edge of the door.

**CE** This appliance complies with the following E.E.C. Directives:

- 73/23 of 19.2.73 (Low Voltage Directive) and subsequent modifications;
- 89/336 of 3.5.89 (Electromagnetic Compatibility Directive) and subsequent modifications.

# Installing

## **Positioning**

Set the machine up as close as possible to a water tap and a connection for waste water.

In order to ensure the door closes and seals properly, it is necessary for the machine to stand firmly and horizontally on the floor.

Adjust the screw feet upwards and downwards until the machine stands level.

## **For built-in appliances only:**

Please consult the enclosed template with the installation instructions.

## **Please note the following before installing:**

When the door is opened after the programme has ended, steam escapes from the machine as a normal operational feature and may cause non-water-tight bonded worktops to swell and warp.

The pack provided therefore includes a metal protection. **In all cases**, this must be properly arranged to prevent subsequent damage to the worktop. The protection should be arranged according to the instructions given on the template.

The automatic dishwasher is then installed in the furniture recess

**When installing the dishwasher in the recess, please make sure that the drain hose, supply hose and electrical supply lead are arranged so that they can move freely in the rear plinth area and so that any kinking or squashing of these connection leads is prevented.**

## **Connecting the water supply**

Your dishwasher has been built in accordance with the valid regulations governing water-consuming appliances and is equipped with safety devices which prevent used water from flowing back into the drinking water mains. Your dishwasher can be connected to either a cold or hot water supply of max. 60°C.

Never connect your dishwasher to open hot water appliances and continuous flow heaters!

The supply hose is fitted with a screwed hose connection (to DIN 259) and can be connected to an outlet valve (water tap) with male thread (3/4").

Suitable washers are supplied with the machine. Do not use any washers other than these!

The nut of the screwed hose connection can be tightened by hand. If you require a supply hose which is longer than the one supplied, use only the VDE-ap-

proved complete hose kit (obtainable from our service centre) continuously and to adequate length.

Never lengthen existing hoses.

**Important note!** The supply hose must not be kinked, squashed, or twisted. Please ensure careful running.

To avoid reductions in water supply to the kitchen, we recommend you to install a separate tap. Failing this, fit a branch piece to the existing water tap. Additional installation expenditure (on the building side) can be reduced by use of conventional sink mixers with connection and shutoff valve.

Minimum water pressure:

0,5 bar (5 N/cm<sup>2</sup>, 50 kPa).

If your water pressure is under 0,5 bar, please ask our service centre for advice.

Maximum allowable water pressure:

8 bar (80 N/cm<sup>2</sup>, 0,8 MPa).

For a water pressure over 8 bar, a pressure-reducing valve (obtainable from your specialist retailer) must be fitted upstream.

## Water Outlet Connection

The end of the drain hose can be connected as follows:

to the sink outlet siphon, securing it if necessary with a clip;

to a wall outlet provided with vent-hole, minimum internal diameter 4 cm.

The waste connection must be at a height of between 30 cm (minimum) and 100 cm (maximum) from the floor.

It makes no difference which way the drain hose faces, either to the right or left of the dishwasher.

Avoid bending or kinking the hose as this could prevent or slow down the discharge of water.

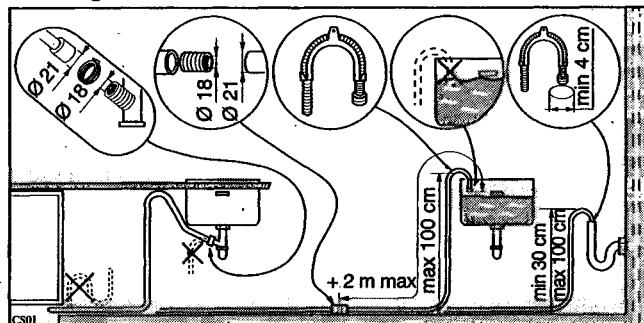



### **Extension hoses**

The necessary extension hoses can be obtained from specialist shops or from our technical assistance centres.

The extension hose must be no longer than 2 metres and its internal diameter must be no smaller than the diameter of the hose provided.

Likewise the internal diameter of the couplings used for connection to the waste outlet must be no smaller than the diameter of the drain hose.

Arrange the extension hose horizontally along the floor and allow it to rise only where it is to be connected to the drain (Fig. 20).

## Electrical connection

### **WARNING - THIS APPLIANCE MUST BE EARTHED.**

Please ensure that the voltage and current indicated in the rating plate agrees with the voltage of your electricity supply: 220/240 volts - (i.e. 220/240 V AC).

If your appliance has been equipped with a mains lead with moulded-on type plug, you must comply with the following regulations: The plug moulded on to the cord incorporates a fuse. For replacement, use a 13 amps BS 1362 fuse.

Only ASTA approved or certified fuses should be used.

The fuse cover/carrier must be replaced in the event of changing the fuse. The plug must not be used if the fuse cover/carrier is lost. A replacement cover/carrier must be obtained from an electrical goods retailer. If the socket outlets in your home are not suitable for the plug fitted to the appliance, then the plug must be cut off and an appropriate one fitted. When fitting the plug please note the following points:

### **IMPORTANT**

**THE WIRES IN THE MAINS LEAD ARE COLOURED IN ACCORDANCE WITH THE FOLLOWING CODE:**

<b>Green and Yellow</b>	<b>Earth</b>
<b>Blue</b>	<b>Neutral</b>
<b>Brown</b>	<b>Live</b>

As the colours of the wires in the mains lead of this appliance may not correspond with the coloured markings identifying the terminals in your plug, proceed as follows:

1. The wire which is coloured **GREEN** and **YELLOW** must be connected to the **EARTH** terminal in your plug, which is marked with the letter **E** or by the earth symbol  or coloured **GREEN**, or **GREEN** and **YELLOW**.
2. The wire which is coloured **BROWN** must be connected to the **LIVE** terminal which is marked with the letter **L**, or coloured **RED**.
3. The wire which is coloured **BLUE** must be connected to the neutral terminal which is marked with the letter **N** or coloured **BLACK**.

**When wiring the plug, ensure that all strands of wire are securely retained in each terminal. Do not forget to tighten the mains lead clamp on the plug.**

**Warning! A cut off plug inserted into 13 amp socket is a serious shock hazard. Ensure that the cut off plug is disposed of safely.**

Voltage	220/240 V AC
Fuse rating	13 amps.

See rating plate for further information.



AEG Hausgeräte AG  
Postfach 1036  
D-90327 Nürnberg 1  
© Copyright by AEG

152995 75/0

0/0996

**AEG Domestic Appliances Ltd**  
Customer Care Department  
55-77 High Street  
Slough  
Berkshire SL1 1DZ

Telephone: 08705 350350