

INSTRUCTION BOOK



Your New Appliance

Thank you for purchasing an AEG appliance.

To enable you to use your new appliance efficiently and safely, please read this instruction book carefully before installing or using the appliance, and retain for future reference. Should the appliance be transferred to a new owner please ensure this instruction book is left with the appliance in order that the new owner can get to know the functions of the appliance and the relevant warnings.

If you require further assistance or advice, please contact our Customer Care Department either by letter or telephone:

Customer Care Department
AEG Domestic Appliances
55-77 High Street
Slough
SL1 1DZ

Tel: 08705 350350*

* calls to this number may be recorded for training purposes

For the User

Your New Appliance	2
Safety Information	5
Product Description	7
Ceramic Hob	8
Induction.....	8
Before use	10
Protect the ceramic hob	10
How to Use	11
Ceramic Hob	11
Touch Controls.....	12
Cooking Zones	12
Residual Heat Indicator	13
Power	14
AUTOMAX	15
Safety Switch-off	17
Autostop	17
Activating the Child Safety Device	18
Minute Minder	20
Timer	21
Suitable pans	23
Advise and Tips for Using the Cooking Zones	24
Cleaning and Maintenance of	25
Aluminium	25
Ceramic Hob	25
What to do if	36
Service and Spare Parts	38
Guarantee conditions	39

For the Installer

Unpacking 26
Technical Specifications 27
Installation..... 28
Mounting 29

How to read the operating instructions

1... 2...Step by step



Hints and tips



Safety information



Environmental information

The products are continuously being developed and it may occur that some product specifications are changed after this instruction book was printed. We therefore have to make reservation for any changes or printing errors.



Safety Information

The hob is intended for domestic use only. If it is used in any other way there is a risk of accidents.

Children

Keep an eye on children when the hob is in use. Pans get very hot when used and remain warm for some time after the hob has been turned off. Never let children touch or play with the controls.

Use

Never leave the hob unattended when deep fat frying, or heating fat and oils. In the event of fire turn off all controls and if you have a cooker hood this must be turned off as well. Never leave paper, dish cloths, aluminium foil or any other easily ignited materials close to the hob. A hot hob can cause foil, plastic or paper to melt or burn.

Put out flames with a lid, and never use water.

Check that the hob is turned off when not in use.
Persons with pacemakers should keep their upper body at a minimum distance of 30 cm from the zones when turned on.
Never place any magnetically charged objects (e.g. credit cards, cassettes etc.) on the vitroceramic

hob while the zones are turned on. Never place metal objects (spoons, pan lids etc.) on an induction zone.

Cleaning and Maintenance

For reasons of hygiene and safety the cooking zones must be kept clean. Grease and spilt food liberate smoke when heated and could cause a fire.

Service

Service and repair must be performed by our service organisation or an organisation approved by us. Only spare parts supplied by our service organisation may be used.

Unpacking

Make sure the packaging is disposed of in such a manner that children cannot access the used packaging.

Installation

The product may only be installed by an authorised electrician or a person authorised by the manufacturer.

Work performed by unqualified persons could lead to injuries or damage to property, and spoil the hob itself. During installation make sure the electricity cable is not pinched.

Disposal

Help prevent accidents when disposing of the product. Remove the cable from the wall plug and cut off the cable close to the product.

Product Description

1. Cooking zone Ø 140 mm, 1400 W.
2. Cooking zone Ø 210 mm, 2200 W, 3000 W power.
3. Control panel

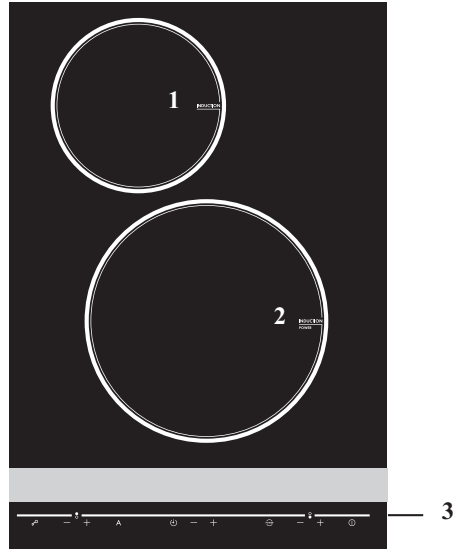

Control Panel

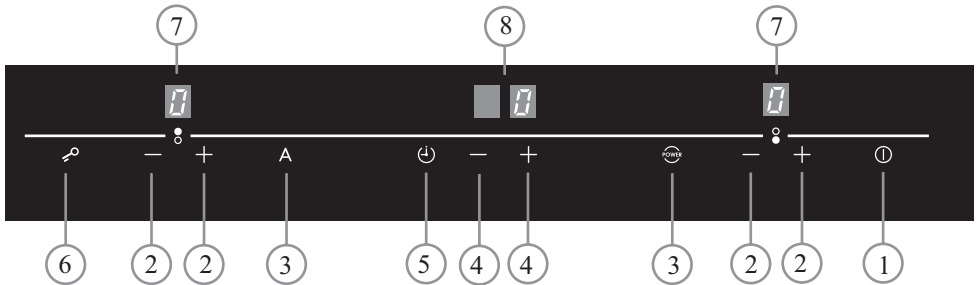

1. On / off
2. Heat setting selectors
3. AUTOMAX/Power
4. Timer
5. Minute minder
6. Child safety
7. Display for setting cooking zones
8. Minute display/timer display

Ceramic hob

Ceramic glass is insensitive to temperature shock and very robust: however it is not unbreakable. Especially sharp and hard objects that fall on the cooking surface can damage it.

Induction

When you switch on a zone, a high-frequency magnetic field is formed between the induction coil and the magnetic base of the pan. This magnetic field contains induction currents. The base of the pan slows down the induction currents, thus forming heat which first heats the pan base and then the food in the pan.

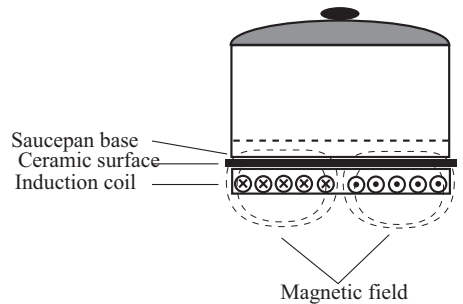

Quicker cooking

With induction, your pans become hot immediately. This means you save time and energy when cooking by induction. As the necessary heat for cooking the food is formed in the base of the pan, the hob hardly gets hot. However, it does absorb the surplus heat from the pan base.

High safety levels

The individual zones will only get hot when a pan with a magnetic base is placed on them. It is impossible to turn on an empty zone. When you remove the pan from a lighted zone, the zone will turn off even if you do not switch it off. Remember that there will still be residual heat in the ceramic hob. The zone will remember the last setting for about 20 seconds.

Overheating protection

When a pan is placed on a zone, the pan will heat up. A sensor under each zone measures the temperature of the zone and the pan. If the temperature gets too high, the zone will automatically switch off.

Quick adjustment

When you turn on a zone, the pan will become hot very quickly. When you turn the heat down, the heat quickly dissipates.

Easy cleaning

Any spills will not burn onto the ceramic hob as the area to the side of the pan is not hot. This makes cleaning the hob much easier.

Power

The front zone has a facility for switching in extra heat to give an even quicker boiling time. When using Power on the front zone the rear zone cannot be set at the highest setting. Information on how to use Power is given in the Section “How to use....Power”.

Cooling fan

A fan protects the electronics from overheating. When you have finished using the zones, the fan will continue to run until the electronics have cooled down.

Electronic control system

The hob has an electronic control system to ensure precise heat control of the zones. The electronics have the following functions:

- Power, extra heat
- AUTOMAX, automatic boiling
- Safety switch-off
- Autostop. Automatic turning off of zones
- Child safety
- Minute minder and timer

Before Use

Protect the ceramic hob

Before using the hob for the first time, clean off any manufacturing residues such as dust, dirt etc.

Apply a protective coating on the ceramic hob before you use it. This way it becomes easier to clean the glass and you prevent any spillage from burning.

This is what you do:

1. Pour a few drops of the cleaning agent supplied with the hob on paper towel and rub it on to the entire surface.
2. Polish the surface with a clean cloth until it is dry.

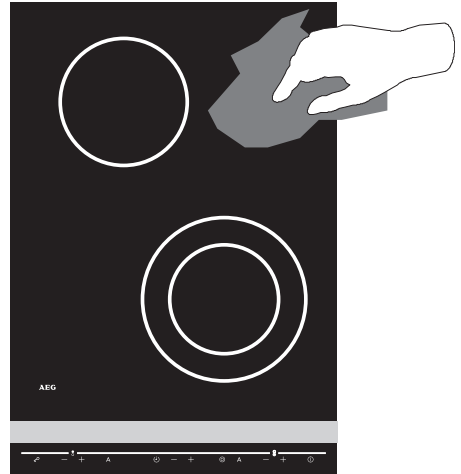

How to use

Ceramic hob



Never use a cracked vitreoceramic hob.

Water could boil over and/or cleaning agents penetrate into the live electrical parts. Switch off the power to the appliance and contact Service.

Never place aluminium foil, paper, plastic or similar on the hob. A hot heating zone could cause foil, plastic or paper to melt or burn.

Never leave the hob unattended when deep frying or melting fat, paraffin wax or other easily ignited substances. In case of fire, turn off all knobs and switch off any cooker hood.

Put out the fire with a lid, and never use water.

Scrape any spills from the hob straight away with a razor. Spills of sugar and sugar-rich foods (jam, fruit syrup etc.), melted plastic and aluminium foil may damage the hob. Never place wet saucepans on the hob.

Make sure there is no sand, sugar or salt on the base of the pan. Sand can cause scratches and sugar and salt can damage the hob.

Always dry pans before placing them on the hob. The coloured decoration on the hob may wear away or suffer scratches depending on use.

Do not use the ceramic hob without the aluminium strip in place.



Do not use the ceramic hob as a work surface as this could damage the hob.

Touch Controls

The sensor fields must be touched for minimum 1 sec. before activation.

Cooking Zones

The cooking zones can be adjusted from 0-9, where 9 is the highest setting.



1. Press the  button.
2. Press  or the  button to set the desired zone.



Adjustment of the zones must take less than 10 seconds, otherwise the cooking section will turn off again.





Press the  button to set the zone level by level from 0-9.

Press the  button to set the zone level by level from 9-0.

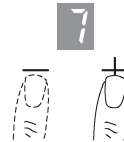
If you keep pressing the  or  button, the adjustment will be quicker - the hob will run through the adjustment levels 1-9 and stop when you reach "0".

If there is no pan on the zone or if the pan is not magnetic, "F" will show on the display for max. 10 sec, after which the appliance will turn off.



Turn off a single zone by pressing the  or  buttons until the display shows “0”. You can turn off a zone quickly by pressing the  and  buttons simultaneously.

Turn off all zones by pressing the  button.

Residual Heat Indicator

Each cooking zone has a residual heat indicator. When the cooking zone is turned off the “H” is lit up in the display until the cooking zone has cooled. “H” is a warning that the cooking zone is still hot.







Power

Switching on power

You can switch the front cooking zone to extra heat for a maximum of 10 minutes .



1. Press the  knob.
2. Set the cooking zone to level “9” by pressing the  or  button.
3. Press the  button.

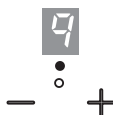

When Power is switched on, the Power control lamp will light and the cooking zone will output 3000 W. Meanwhile the rear right-hand cooking zone will provide a maximum 600 W output, corresponding to level 7. If you attempt to turn the rear right-hand cooking zone to a level higher than level 7 while the front right-hand zone is set to Power, Power will automatically be turned off. The front cooking zone will then continue operation at level 9.



Deactivating Power

1. Press .



Changing from Power to a different level

1. Press .
2. Press  or  until the desired level shows on the display.

Automax

With AUTOMAX you do not need to turn down the temperature. When using AUTOMAX the zone gets full heat for a certain amount of time where after the cooking zone automatically adjusts to the setting you have chosen.

To adjust AUTOMAX you have to do the following:

1. Turn on the hob, push .
2. Adjust the desired cooking zone at the setting you wish to use.
3. Push .



When AUTOMAX is coded the control lamp for “A” will light up.

To turn off AUTOMAX, you have to push .



The “AUTOMAX” chart on the following page gives guidelines for suitable heat settings for different types of cooking.

AUTOMAX Settings

Food types	Cooking process		Time to automatic cutout	Notes
Steaks	Quick frying	A7-A8	2½ mins	Fry 3-4 min per side depending on thickness.
Schnitzels Meat balls Fried eggs Sausages	Frying	A6-A7	1½-2 mins	Turn regularly
Pancakes Fritters	Gentle frying	A6-A7	1½-2 mins	
Potatoes Vegetables	Boiling/ steaming	A6	1½ mins	Use little water: Max 2 dl water to 1 kg potatoes
Omelette, Scrambled eggs	Thickening	A6	1½ mins	
Chocolate Butter Gelatine	Melting	A2	16 secs	Without water bath. Stir frequently

Safety Switch-off

If one of the keys are activated for more than 10 seconds (e.g. by a child, pot spillage etc.) the hob is automatically switched off.

Autostop

If by mistake one or more cooking zones have not been switched off Autostop will automatically switch off the hob after a certain amount of time. The time depends on the heat setting selected. See below table. When Autostop has been activated the indicator light for  flashes.

Push  to reset Autostop.



Setting	Max hours before auto turn-off
1-2	6
3-4	5
5	4
6-9	1,5



Activating the Child Safety Device

With the child safety function children can be prevented from turning on the hob unintentionally.





When the child safety is activated you can still use the  key and the minute minder.

Activating the Child Safety Device

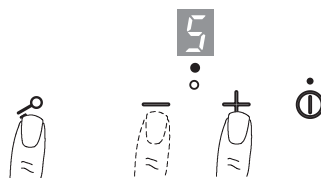

1. Turn on the hob, push the  key
2. Push the  key for 3 seconds.
The control lamp for child safety lights up.



If you try to turn on the hob when the child safety is activated  and  will illuminate.



Push again on  to turn off.

To use the hob when the child safety is activated do the following:

1. Push the  key.
2. Push the  key and the key you wish to use simultaneously.

The child safety is cancelled while the hob is in use. When the hob is turned off the child safety is automatically activated.

Cancelling the Child Safety





1. Push the  key.
2. Push the  key for 3 seconds.

The control lamp for child safety turns off.

Minute Minder

Setting the Minute Minder

The minute minder can only be used when the timer is not in use.

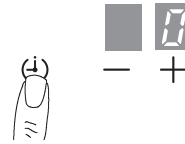

1. Turn on the hob, push .
2. Push once on .
3. Push the  or  key till the desired time is shown in the display.



When the time has run out you will hear an acoustic signal.

De-activating the Minute Minder

If you wish to de-activate the minute minder before the time is up you have to do the following.

Push simultaneously on the   keys for 3 seconds.

In the display it will say "0". After a few seconds the display is turned off.

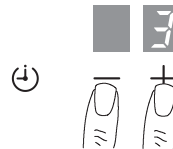



Timer

This function can automatically turn off a cooking zone at any given time.

When this function has not been chosen the clock can be used as a minute minder (see the section “Minute minder”)

Timer and minute minder cannot be used simultaneously.

Setting the Timer

1. Turn on a cooking zone.
2. Push the  key 2 or 3 times to select the cooking zone you wish the timer to control. The control lamp for the actual zone lights up. The display shows “0”.
3. Push the  or  key to set the time. The time is shown in minutes. If the two keys are held down for more than 3 seconds the timer can be set faster with 5 minutes intervals (5-10-15.....minutes) The last minute is shown in seconds.

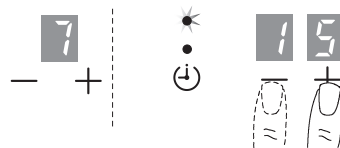
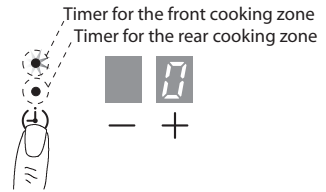

Both cooking zones can be set simultaneously with two different timings. When both cooking zones have a setting the time for the individual cooking zone is read in the following way:

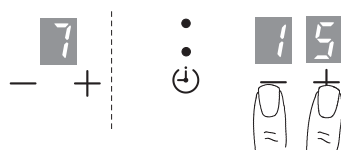



The time in the display belongs to the cooking zone for which the control lamp is lit. Push  to see the time for the other cooking zone.

When the set time has passed you will hear an acoustic signal. The timer and the cooking zones are automatically turned off.



The control lamp for the other cooking zone will flash while the first timer is activated. When the time for the first zone expires the remaining time for the other cooking zone is shown in the display.

Cancelling the Timer

If you wish to cancel the timer before the time is up you have to do the following. Push the   keys for 3 seconds. The display will show "0". After a few seconds the display will turn off.

Suitable pans



When using non-stick pans, do not use level 9 or Power, as the non-stick coating may be damaged by the high induction heat.

- The induction hob can only be turned on when a cooking utensil with a magnetic base is placed on one of the zones. You can use the following utensils:
- Pans marked as suitable for induction.
- Cast iron pans. Make sure the base is smooth. A rough base could scratch the ceramic hob.
- Enamelled steel pans. Make sure the enamel is suitable for use on ceramic surfaces. Some enamels can scratch the ceramic hob.

You can test whether your pans are suitable by placing a magnet on their base. If the magnet sticks, the pan is suitable.

Unsuitable pans

Pans made of aluminium, copper, brass, glass, porcelain and steel and which do not have a magnetic base.

Size of pans

The zones automatically adapt their size to the base of the cooking utensil, within certain limits. The pans must have a definite minimum size, which will depend on the diameter of the zone, otherwise the zone will not turn on.

Small zone: Ø 14 cm.

Base of cooking utensil min: Ø 10 cm.

Large zone: Ø 21 cm.

Base of cooking utensil min: Ø 18 cm.



Check the base diameter when buying, as pan manufacturers often give the diameter of the top edge of the pan.

Advise and Tips for Using the Cooking Zones



By using the advise below you can save energy and ease cleaning.

▲ Use close-fitting lids on the pans.

Failure to use a lid on a pan uses over three times as much electricity.

▲ Save water: Boil in as little water as possible. Cook potatoes and vegetables in 1, 2 or 3 dl water.

Use 1 dl water for the 14 cm zone.

Use 3 dl water for the 21 cm zone.

Cover the pan with a close-fitting lid. Bring to the boil at the highest heat and then turn down to the lowest possible heat when steam starts emerging strongly from the lid. Calculate the cooking time from when you turn down the heat. Avoid looking at potatoes/vegetables until the cooking time is complete.

▲ **Turn down immediately the pan starts to boil.** Choose the correct heat setting. Start at the highest setting and turn down as far as possible without the food going off the boil.

▲ Use the hot zone for the next pan.

▲ Defrost food in the refrigerator.

▲ It saves energy to cook in a pan on a zone rather than in the oven.

Cleaning and Maintenance

Aluminium

Carry out daily cleaning with a well wrung-out cloth. For more stubborn soiling, use a cloth or a soft plastic sponge together with washing-up liquid or all-purpose cleaner.

Never use metal cleaning pads, metal wool, hard plastic sponges, scouring powder, soft soap or other abrasive or caustic cleaning agents.

Ceramic hob

Immediately scrape off any sugar or sugary food stains (jam, juice etc.), melted plastic and aluminium foil from the hot hob. If the hob cools before these materials have been removed it may become damaged. A stained hob reduces the heat transfer between cooking zone and pan. Dry off cooking zones with a damp cloth with washing-up liquid. When heavily stained you can do the following:

1. Remove stains etc. using the ceramic hob scraper.
2. Make sure the ceramic hob has cooled down. Use the cleaning liquid supplied with the hob. Follow the instructions on the cleaning liquid.

3. Wipe the hob with a damp cloth or kitchen paper. Stubborn stains are removed by rubbing hard on the stain with a cleaning liquid on paper towel.
4. Using a damp cloth wipe off any excess cleaning liquid
5. Wipe with a dry cloth.

Make sure that the ceramic hob is dry when heated. A damp surface can develop rainbow-like stripes when heated.

Unpacking

Check that the appliance has no faults and is undamaged on delivery.

Transport Damages

Any damages resulting from a transport which you have not performed yourself must be communicated to the dealer within one week of receipt of the product.

On the rating plate which is placed on the back of the product you will find the CE marking and the product's serial number. Write the serial number on the front of this instruction book so it is easily accessible in the event of service.

Removal of Packaging

All packaging can be recycled. Contact your local authority if you do not know where to dispose of the packaging.

Technical Data

Model FM 4803K-an:

Product measurements:

Width:	360 mm
Depth:	520 mm
Height:	49 mm

Build-in measurements:

Width:	340 mm
Depth:	490 mm
Height:	38 mm

Measurements / power

Front cooking zone: 210 mm	2200W , 3000 W Power
Rear cooking zone: 140 mm	1400 W

This unit is  labelled to indicate conformity with the lowvoltage directive (73/23/EEC) and the EMC directive (89/336/EEC).

Installation

Electrical Installation



Installation may only be performed by a qualified electrician or a person authorised by the manufacturer. Work performed by an unqualified person may cause injury or damages to property and deteriorate the hob.

Connecting the Appliance

Single phase

Type of cable: 2,5 mm² twin and earth.

Installation must comply with any special requirements laid down by the local energy provider. The product must be connected via an external switch with a contact gap of at least 3 mm. (May be the main switch).

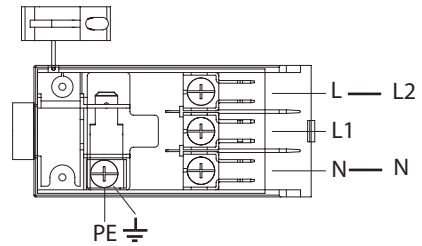

Mounting

The unit may be mounted in any type of kitchen worktop with a thickness of 28 to 40 mm.

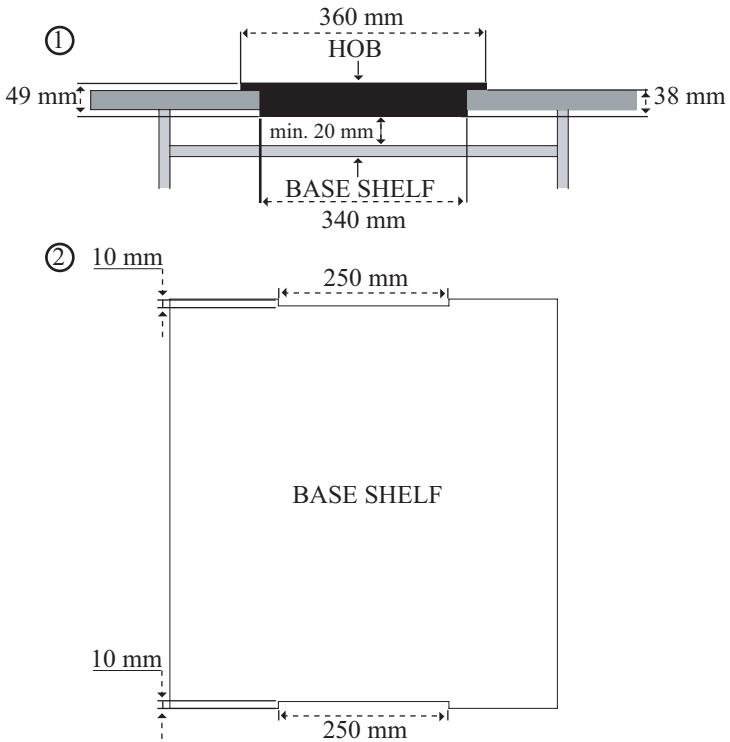

Installation in cupboard WITHOUT oven

To ensure the necessary air supply to the appliance, the top of any floor cupboard must be removed. If this is not done, the air supply will be correspondingly reduced and the guarantee will be invalid.

The distance between the lower surface of the appliance and shelves/drawers must be min. 20 mm.

If the appliance is installed with a base shelf underneath, two cutouts must be created in the shelf - one at the front and one at the rear - to provide sufficient ventilation to the electrical components.

The cutouts must be min. 10x250 mm.

Installation in cupboard WITH oven

If the appliance is installed with an oven located below it, there must be no intervening shelf/panel.

The distance between the top of the worktop and the top of the oven must be min. 60 mm (thus ensuring that the distance between the top of the oven and the lower surface of the appliance is greater than 20 mm).

Cutting Out

When mounting this unit: Read the instructions on this page. When mounting the hob together with other units: Read the instructions on the next page.

For mounting the hob you need a Philips screwdriver and the 4 clamping fittings supplied with this product (see fig.).

Distance to Wall:

Minimum 150 mm to flammable material. Minimum 50 mm to non-flammable material.

1. Cut a hole in the table top according to the measures stated. See “Technical data”, “built-in measurement”.
2. Place the unit upside down on a mat. Take care that the top side is not scratched.
3. Mount the clamping fittings in the holes in the side of the base panel (see fig.)
4. Place the unit in the hole and tighten the clamping fittings to the table top using a screwdriver.

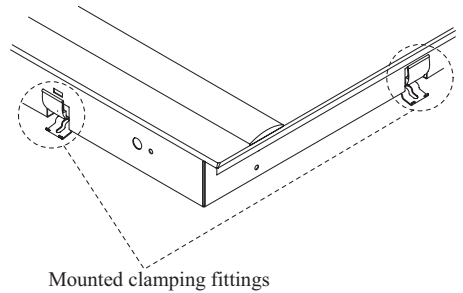
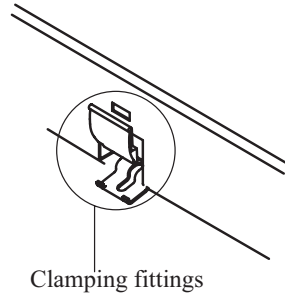

Mounting more than one hob

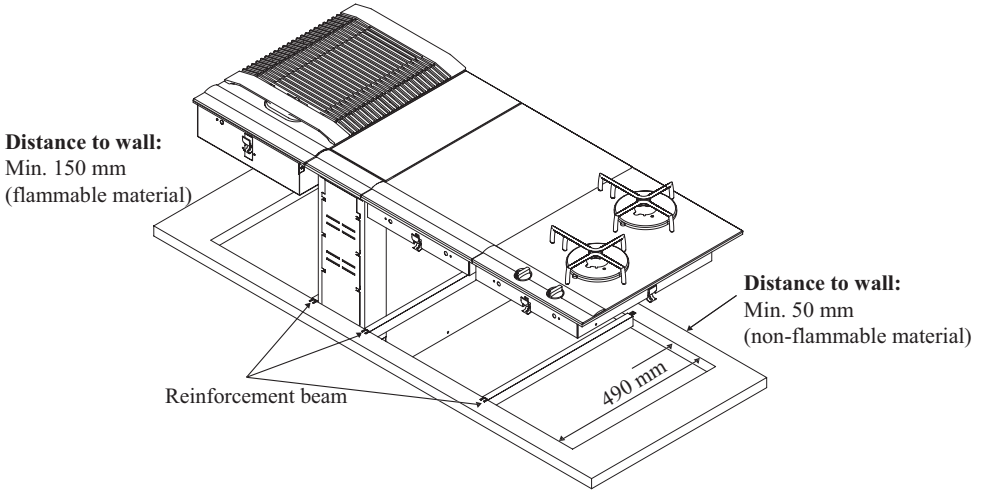

Cutting out

The measurement of the selected combination is calculated in the following way:

Depth: 490 mm

Width:

1. Calculate the sum of all units' width.
2. Subtract 20 mm from the total width.

Example:

A hob of 720 mm + a downdraft of 180 mm + a gas hob of 360 mm.

1. $720+180+360= 1260$ mm
2. Width of the hole: $1260-20=1240$ mm

Distance to Wall:

Min. 150 mm to flammable material.

Min. 50 mm to non-flammable material

Mounting:

When mounting several hobs together you must use a reinforcement beam between each hob as well as the silicone supplied with the hobs (see fig.)

1. Cut a hole of the calculated size in the table top
2. Place the individual hobs upside down on a mat. Take care that the top side is not scratched.
3. Mount the clamping fittings in the holes in the side of the base panels (see fig.)
4. Place the first hob in the hole.
5. Apply silicone to the two corners joining the next hob (see fig.)
Use only the silicone supplied with the hobs as this is intended to tolerate the high temperatures of the appliance.
6. Push a reinforcement beam up against the hob. Apply silicone on the reinforcement beam (see fig.)
7. Tighten the clamping fittings to the table top using a screwdriver.
8. Repeat the process for the other hobs.

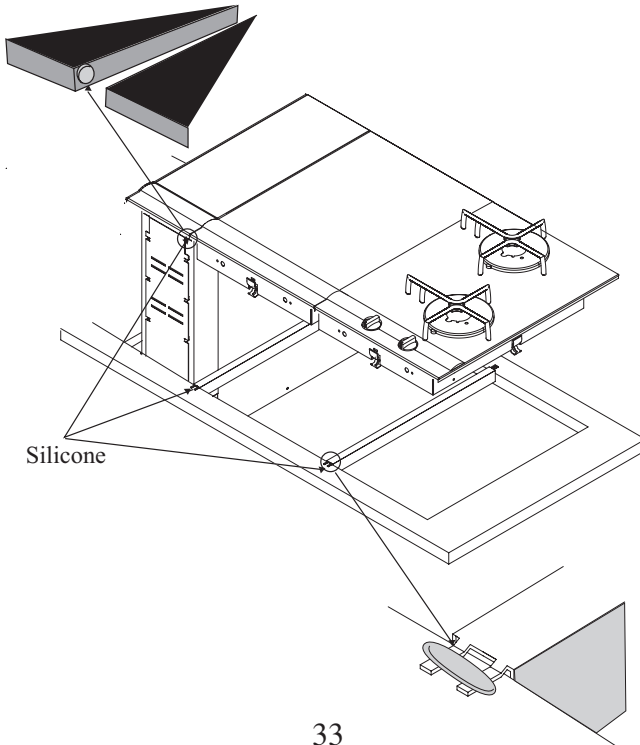

To optimise joints between the installed hobs, the gap between the ceramic hob may be grouted with silicone:

1. Remove the aluminium panels from the hobs.
2. Apply a stripe of silicone to the gap between the two ceramic hob. Use only the silicone supplied, as it is designed to tolerate the appliance's high temperature. (Fig. 1)
3. Splash a little soapy water (washing-up liquid) on the silicone stripe
4. Press the rubber block hard against the ceramic hob and pull it slowly from back to front (Fig. 2)
5. Leave the silicone to harden until the next day.
6. Remove surplus silicone coating from the ceramic hob with the razorblade supplied. Be careful not to damage the silicone in the gap. Run tools only along the joint, never across it.
7. Polish the ceramic hob with the supplied cleaning product for ceramic hobs.

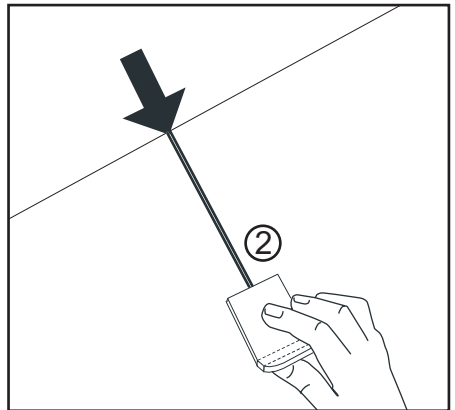
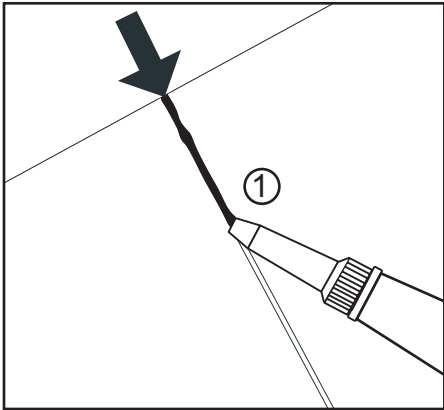

Overview of the outside width of the units

180 mm

Downdraft

360 mm

Glass ceramic hob with 2 cooking zones

Gas hob with 2 burners

Induction hob with 2 cooking zones

Grill

Grill / Fryer

Wok

580 mm

Glass ceramic hob with 4 cooking zones

Gas hob with 4 burners

720 mm

Glass ceramic hob with 4 cooking zones

Gas hob with 4 burners





Induction hob with 4 cooking zones

What to do if...

If the appliance is not working correctly, please carry out the following checks before contacting your local AEG Service Force Centre.

IMPORTANT: If you call out an engineer to a fault caused by incorrect use or installation, a charge will be made even if the appliance is under guarantee.

Problems	Remedy
The hob doesn't work.....	Check that the hob is switched on. Check the HPFI/HFI relay in the main fuse box. Check the fuses for the hob.
The hob gets hot.....	The hob may get as hot as 60°C.
The fuses are constantly blowing.....	Possibly, you have too many electrical appliance in use at one go. If your hob is connected to a 10 Amp fuse group, there is a high risk of overload.
The zones make clicking and other noises	<p>During use there will be noise from the induction coil and the fan. This is completely normal and has no effect on cooking performance.</p> <p>However, some pans can increase the noise. If the noise becomes a nuisance, one option could be to use a different pan.</p> <p>At the low heat settings, clicks will be heard. These occur when the heat is being switched on and off. This is completely normal and has no effect on cooking performance.</p>

Problems	Remedy
<p>The zones won't turn on. The display shows:</p> 	<p>Child safety has been activated. You can either press the  button at the same time as you make a selection, or you can cancel the child safety device, see Section "How to use .. Child safety".</p>
<p>The zones won't turn on and the display shows:</p> 	<p>Autostop has been activated. Touch the  button. The hob is now ready for use.</p>
<p>The display is flashing "F".</p> <p>If the rear zone is set to levels 8 or 9 while the front zone is set to Power, the front zone will revert to level 9.</p>	<p>Check whether the zones are sufficiently covered by the pan. See the section "How to use...Suitable pans"</p> <p>Check that the pans are suitable for induction. See the section: "How to use...Suitable pans" If "F" still flashes, contact service. See section "Service and spare parts".</p> <p>The front and rear zones are connected. If you wish to use setting 8 or 9 on the rear zone, the front zone cannot be set higher than level 9. Power will automatically be turned off.</p>

In-guarantee customers should ensure that the above checks have been made as the engineer will make a charge if the fault is not a mechanical or electrical breakdown.

Please note that it will be necessary to provide proof of purchase for any in-guarantee service calls.

Service and Spare Parts

In the event of your appliance requiring service, or if you wish to purchase spare parts, contact your local AEG Service Force Centre by telephoning:

08705 929 929

Your call will automatically be routed to the Service Centre covering your post code area.

For the address of your local Service Force Centre and further information about Service Force, please visit the website at www.serviceforce.co.uk

In-guarantee customers should ensure that the recommended checks under the heading “What to do if..” have been made as the engineer will make a charge if the fault is not a mechanical or electrical breakdown.

Please note that proof of purchase is required for in-guarantee service calls.

Help us to help you

Please determine your type of enquiry before writing or telephoning. When you contact us we need to know:

1. Your name, address, post code and telephone number
2. Clear and concise details of the fault.
3. Date of purchase
4. The model and serial number

This information can be found on the rating plate.

Customer Care

For general enquires concerning your AEG appliance or for further information on AEG products, please contact our Customer Care Department at the address below or visit our website at www.aeg.co.uk

Customer Care Department
AEG Domestic Appliances
55-77 High Street
Slough, Berkshire
SL1 1DZ
Tel 08705 350350*

***calls to this number may be recorded for training purposes**

GUARANTEE CONDITIONS

Standard guarantee conditions

We, AEG, undertake that if within 12 months of the date of the purchase this AEG appliance or any part thereof is proved to be defective by reason only of faulty workmanship or materials, we will, at our discretion repair or replace the same **FREE OF CHARGE** for labour, materials or carriage on condition that:

- The appliance has been correctly installed and used only on the electricity or gas supply stated on the rating plate.
- The appliance has been used for normal domestic purposes only, and in accordance with the manufacturer's operating and maintenance instructions.
- The appliance has not been serviced, maintained, repaired, taken apart or tampered with by any person not authorised by us.
- All service work under this guarantee must be undertaken by a Service Force Centre. Any appliance or defective part replaced shall become the Company's property.
- This guarantee is in addition to your statutory and other legal rights.
- Home visits are made between 8.30am and 5.30pm Monday to Friday. Visits may be available outside these hours in which case a premium will be charged.

Exclusions

This guarantee does not cover:

- Damage or calls resulting from transportation, improper use or neglect, the replacement of any light bulbs or removable parts of glass or plastic.
- Costs incurred for calls to put right an appliance which is improperly installed or calls to appliances outside the United Kingdom.
- Appliances found to be in use within a commercial environment, plus those which are subject to rental agreements.
- Products of AEG manufacture which are not marketed by AEG.

European Guarantee

If you should move to another country within Europe then your guarantee moves with you to your new home subject to the following qualifications:

- The guarantee starts from the date you first purchased your product.
- The guarantee is for the same period and to the same extent for labour and parts as exists in the new country of use for this brand or range of products.
- This guarantee relates to you and cannot be transferred to another user.
- Your new home is within the European Community (EC) or European Free Trade Area.
- The product is installed and used in accordance with our instructions and is only used domestically, i.e. a normal household.
- The product is installed taking into account regulations in your new country.

Before you move please contact your nearest Customer Care centre, listed below, to give them details of your new home. They will then ensure that the local Service Organisation is aware of your move and able to look after you and your appliances.

France	Senlis	+33 (0)3 44 62 29 29
Germany	Nürnberg	+49 (0)800 234 7378
Italy	Pordenone	+39 (0)800 117511
Sweden	Stockholm	+46 (0)8 672 53 60
UK	Slough	+44 (0)1753 219899

 **From the Electrolux Group.** *The world's No.1 choice.*

Electrolux is the world's largest producer of powered appliances for kitchen, cleaning and outdoor use. More than 55 million Electrolux Group products (such as refrigerators, cookers, vacuum cleaners, chain saws and lawn mowers), are sold each to a value of approx. 14 billion USD in more than 150 countries around the world.