

Freestanding Electric Cooker

FV 64.1 GL

Operating Instructions

Please read and follow the instructions in this booklet

For details on installation see page 22—26

Contents	page
Figures (unfold pages for easy reference)	3—6
Features	7
Before using the cooker for the first time	7
To comply with safety regulations we have to draw your attention to the following	8
Further Technical Advice	8
Important note concerning enamelled parts	8
Using the cooking areas	9—10
Getting to know your oven	11/12
How to select the different cooking methods	13—14
Defrosting with Ventitherm	15
Preserving with Ventitherm	16
Electronic clock, minute minder, time controlled cooking	17/19
Using the Warming drawer	20
Cleaning and maintenance	21—24
Optional extras	25
Installation	26
If you think your cooker is not working properly	27
Service	28



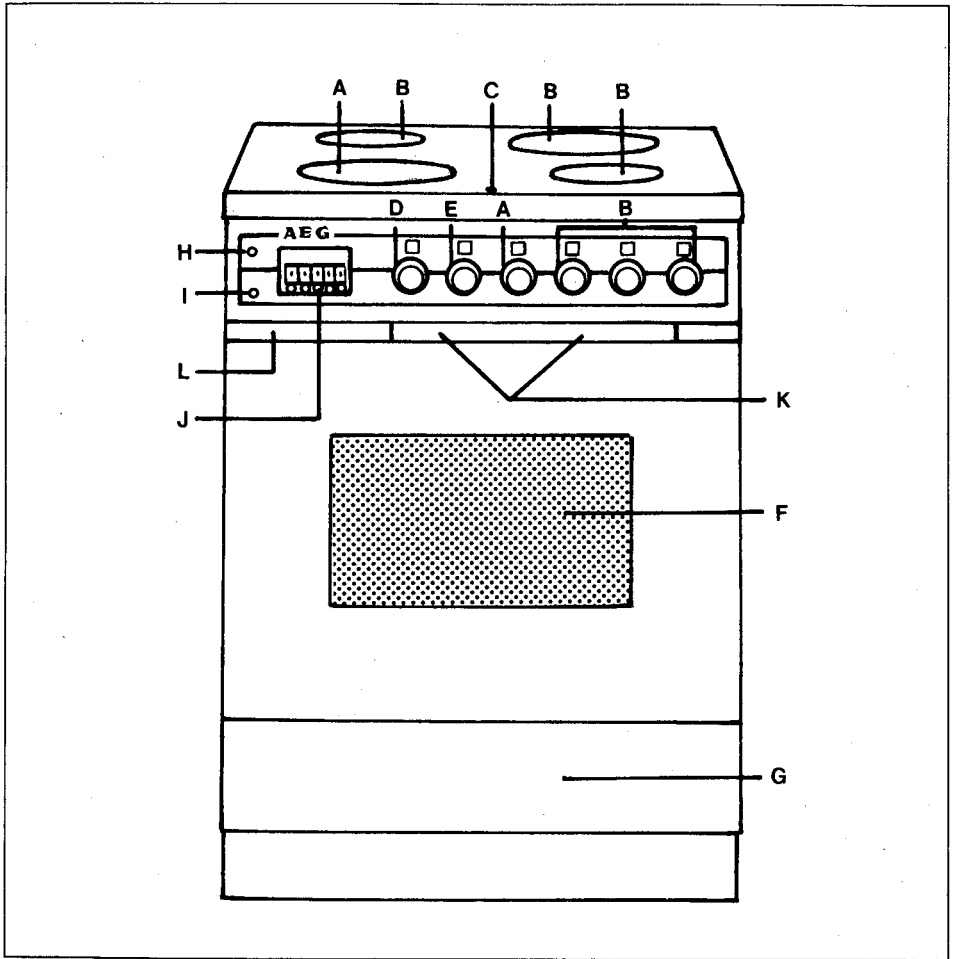

1

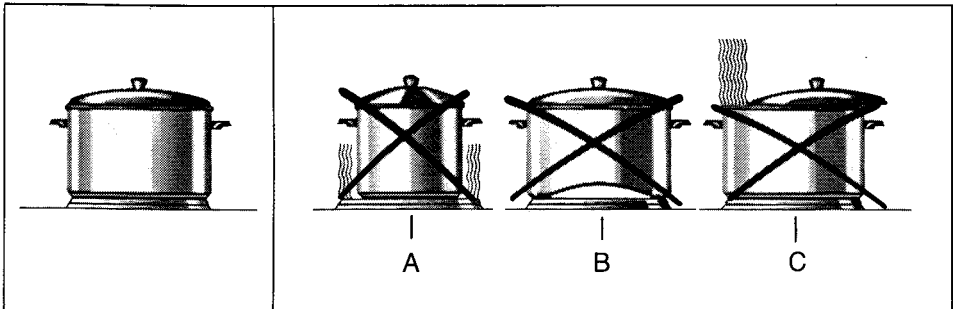

2

3

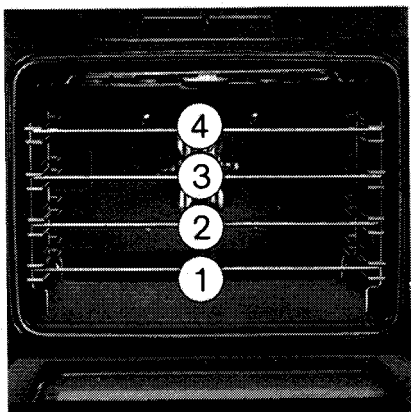

4

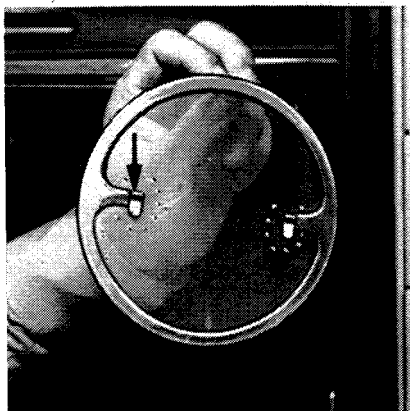

5

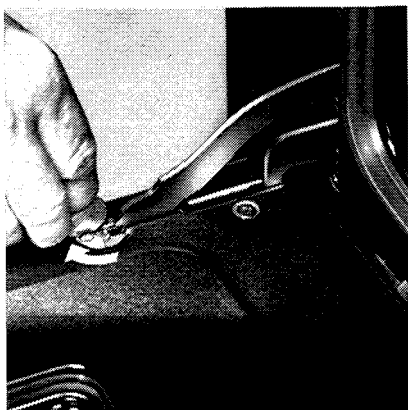

6



7

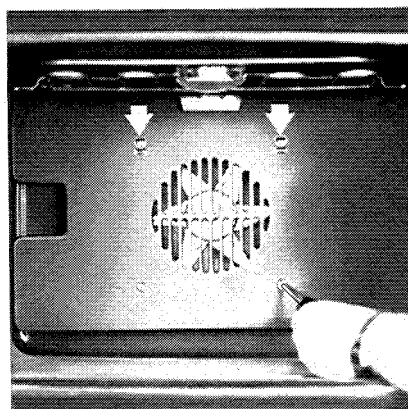

8

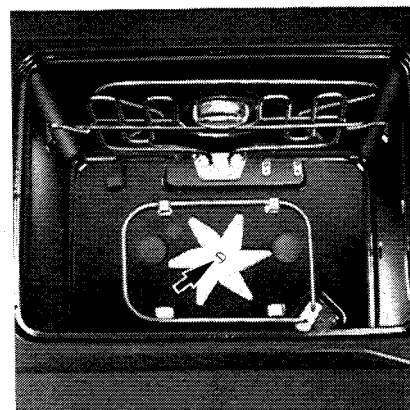

9

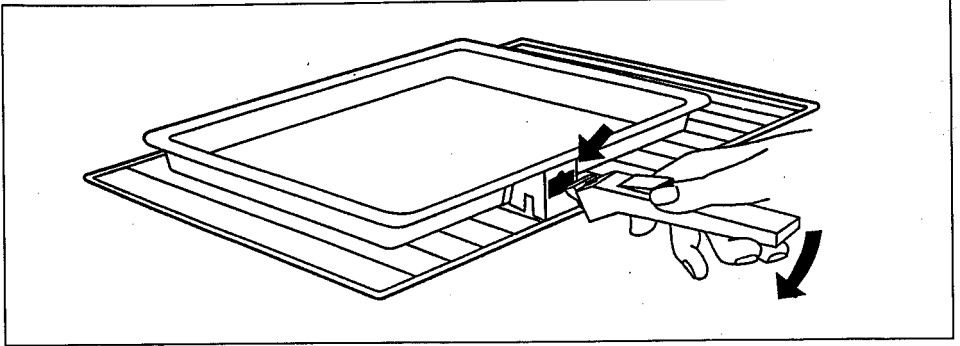

10

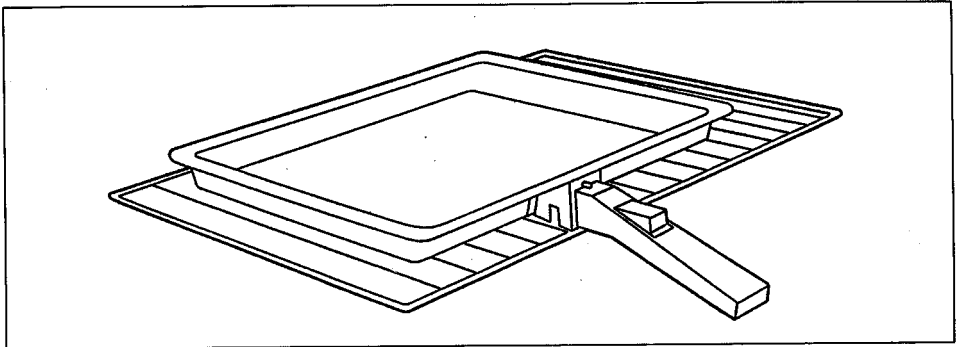

11

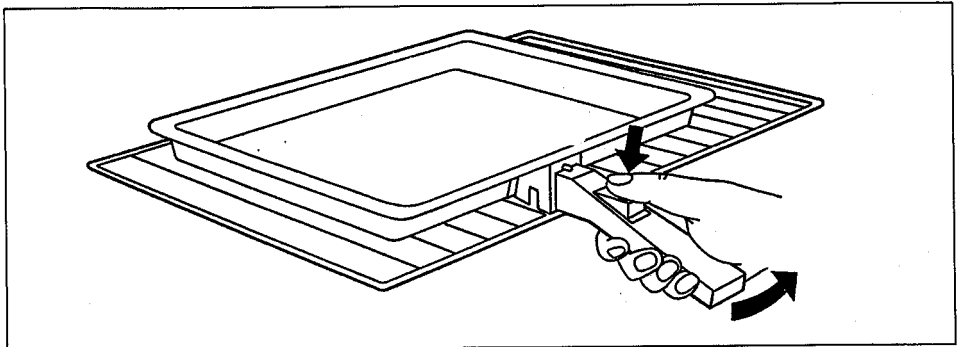

12

Features

Figure 1

- A Automatic cooking area and relevant control knob
 - B Fast cooking areas and relevant control knobs
 - C Residual heat indicator
 - D Cooking method selector for: Ventitherm, Conventional Cooking, Grilling, Infra-therm roasting/grilling
 - E Temperature control knob
 - F Oven with interior light and grill element
 - G Warming drawer
 - H Red thermostat light for the oven
 - I Yellow pilot light
 - J 24 hour electronic clock with automatic STOP and START/STOP cooking and minute minder
 - K Handle
 - L Vapour vent (becomes hot when in use)
-

Before using the cooker for the first time

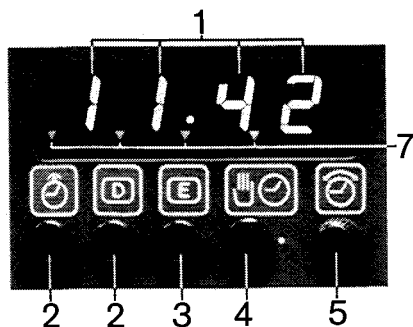

First set the time of day on the clock

After installation of the appliance (and also after a power cut) the display on the electronic clock flashes "00.00".

Now press the two input buttons "2" simultaneously and set the time of day by turning the knob 5.

As soon as the correct time of day appears in the display 1 release the buttons. The time is now set. The oven is ready for use.

To switch on the oven

Remove all oven accessories and clean with hot water and washing-up liquid. Switch on the empty oven by selecting symbol  on the Cooking Method Selector (fig. 1/D) and 250°C on the Temperature Control (fig. 1/E) and leave for 30 minutes to burn off the

bonding agent incorporated in the oven insulation. During this time there will be an unpleasant odour which is unavoidable. When the oven has cooled down clean it with hot water and washing-up liquid.

To comply with safety regulations we have to draw your attention to the following

- In all cases the appliance may only be connected to the electricity supply by an approved electrician. This will ensure that the legal requirements and the conditions of connection of your local electricity supply authority are observed.
- The appliance should be connected to the mains via a standard cooker control unit.
- The surface of cooking appliances get hot during operation. Take care and always keep small children away from cooking appliances.
- Overheated fat and cooking oil may ignite. Prepare foods requiring fat or oil (chips) only under constant supervision.
- Please ensure that leads from other electrical appliances (e.g. small appliances) do not touch the hot cooking areas or the oven door.
- Never allow children near a cooker when you use the grill.
- **Warning:** electrical appliances should only be repaired by qualified AEG engineers or AEG appointed service agents, repairs carried out by unauthorised personnel could lead to considerable damage.

Further Technical Advice

Cleaning Advice

Do not use oven cleaning materials on painted, lacquered, anodized, zinc coated or aluminium parts. If you do, damages and discolourations can occur.

Warning:

The appliance must not be used for heating purposes.

Please note that any adhesive used to fix plastic coverings or veneer to the furniture housing must be heat resistant (150°C).

Unsuitable plastic coverings and adhesives which are not heat resistant are the reason for the plastic covering deforming or separating particularly along the narrow sides.

Important note concerning enamelled parts

- Vitreous enamel is a hard glass-like material and very susceptible to damage. Take care when using sharp or heavy utensils.

Vitreous enamel can chip when knocked or a heavy article drops on to it.

Do not line the oven or any part thereof with aluminium foil. Do not place any cooking containers on the base of the oven. This tends to trap heat resulting in poor cooking performance and damage to the enamelled interior. This invalidates the warranty.

Using the cooking areas

The correct cooking utensils

Good quality utensils and pans with level bases require less energy and therefore a lower setting.

Perfectly flat and thick bases are more important than the material of which the utensil is made. (saucepans with sandwich bases are best).

To check your pans place a ruler across the base or hold the base against the edge of your worktop.

Even if the base is only slightly distorted, the base of the utensil will not make good contact with the cooking area and the pan is unsuitable.

How to save energy

Fig. 2

Pan has a thick and flat base which covers the cooking area completely ensuring very good heat conduction.

How energy is wasted during cooking

Fig. 3/A Pan is too small for cooking area.

Fig. 3/B Pan base is uneven.

Fig. 3/C Saucepan lid is not fully on.

Vitramic hob (fig. 1)

- Only use pans suitable for electric hobs with flat and smooth bases. Do not use cast-iron pans or pans with rough, damaged or uneven bases as they will damage and discolour the cooking areas. To check whether the pan base is perfectly flat, place a ruler across the base. Even if the base is only slightly distorted the base of the pan will not make good contact with the cooking area and is unsuitable.
- Dry pan bases before use to prevent damage to the hob.
- Choose the right cooking area for your pan; pan base to be of the same size as the cooking area.
- Make sure the pan is placed in the centre of the outlined cooking area.
- Make sure that the cooking areas and the pan bases are clean before use. Grit for instance from vegetable peelings will scratch and damage the hob surface. Residual cleaning material but also food residues, particularly those containing sugar, will burn into the hob surface and

cause damage. We would recommend that you read our advice on cleaning and maintenance page 16 before you start using the hob.

- The hob is very durable but under certain circumstances it can break e.g. heavy or pointed objects dropping on to the surface.

Important: In case of breakage or cracks do not use the hob. The electrical supply to the hob must be switched off. Contact AEG Service department as soon as possible.

Do not use the ceramic hob as a table top.

Do not use the ceramic hob to cook food in aluminium foil or plastic containers.

- As soon as you switch on a cooking area you will hear a faint hum caused by the radiant heating elements. This will cease after a little while.
 - The hob incorporates a residual heat indicator (**fig. 1/C**) which glows to warn you that the cooking areas are still hot. When the cooking areas have cooled down the indicator light goes out.
-

Using the cooking areas

General

Your cooker has 1 automatic cooking area (fig. 1/A) and 3 fast cooking areas (fig. 1/B).

The symbols above the control knobs indicate which cooking area is operated by the individual switch. The cooking area is

switched off when the "0" on the control knob is under the vertical line (fig. 1/A/B). The control knobs may be turned clockwise or anti-clockwise. The yellow pilot light (fig. 1/I) will glow as soon as a cooking area is switched on.

Using the fast cooking areas

The fast cooking areas have a higher connected load than a standard cooking area.

Cooking

To bring food to the boil select setting 3, continue cooking on setting 1. Depending on the quantity of food cooked, a higher or lower setting may be used.

Frying

Select setting 3 until the fat in the frying pan is hot. Put in food and turn to setting 2. Depending on how fast the food should be fried a higher or lower setting may be selected.

Settings	Suggested uses for cooking
3	Bringing food to the boil before switching to simmering. Heating of frying pan
2—3	Quick frying, sealing of meat
2	Frying of foods requiring lower temperatures
1—2	Simmer for large quantities of food
1	Simmer for average quantities
0—1	Keeping food hot
0	Residual heat, "0" position

Using the automatic cooking area

The automatic cooking area enables you to cook with the least amount of supervision. This means the cooking area operates on an increased amount of electricity initially between settings 1—7 to heat the area, pan and contents and then switches automatically to a lower output to complete cooking at a slower rate. The chart below will give you some recommendations for use of the various settings relating to quantities for four persons. These recommended settings are guidelines only and may have to be altered depending on quantities of food cooked and type of cooking utensil used.

How to switch on the automatic cooking area

- Place pan on the cooking area required.

- Turn control knob to the required setting, e.g. 5—7 for potatoes, give the control knob a slight pull to activate the boost. The cooking area will switch down automatically to a slower rate of cooking.

To switch on the cooking areas without using the automatic system

The automatic cooking area can also be used as a fast cooking area. To bring food to the boil select setting 12, then select a setting between 3—6 for the remaining cooking time.

To alter a setting

Switch from the wrongly selected setting to the new setting required. The heat boost is automatically adjusted to suit the new setting.

Using the automatic cooking area

Guidelines for automatic cooking areas

Switch settings	Suggested uses
12	Fast frying, deep fat frying, to bring large quantities of liquid to the boil
11	Deep fat frying or sealing of meat
10—11	Fast frying of meat, pancakes
9—10	Frying of meat, fish, sausages and pancakes, hamburgers
8—9	Slow frying, eggs, liver, preparing roux
5—7	Cooking larger quantities of food, stews and soups, potatoes
4—6	Boiling potatoes, soups
3—5	Steaming vegetables or fish in own juice, pot roasting
2—4	Re-heating food, cooking rice, small amounts of potatoes, vegetables, simmering
1—2	To keep food hot, to prepare egg or cream sauces. To melt butter, chocolate, gelatine
0	Residual heat, "0" position

Getting to know your oven

General

Your oven incorporates five cooking methods from which you can choose:

1. Ventitherm fan cooking
2. Conventional cooking
3. Traditional grilling
4. Infra-therm roasting/grilling
5. Hot air grilling

For roasting, stewing and baking choose either the fan or the conventional cooking method depending on your personal preference.

Consult your AEG recipe book for details.

For batch baking and complete meal cooking choose the Ventitherm cooking method as you can cook on several levels simultaneously. This will save time and energy.

Important

- The vitreous enamel in your oven is very durable. However vitreous enamel is adversely affected by fruit acids (rhubarb, lemon etc.) and tea which will discolour and dull the enamel. The performance of the oven is not affected. To prevent spillage of the above coming in contact with the enamel, place the cooking container on a baking sheet.
 - Clean the oven after every use to prevent a build-up of soilage. To aid cleaning of the oven a 3-piece catalytic liner set is available as an optional extra, (see page 23 "optional extras").
 - It is quite normal for some steam or condensation to develop when cooking foods with high moisture content or large quantities of food.
 - **Do not place the grill/meat pan on the cooking plate to make gravy.** The direct heat will weaken the pan base resulting in warping and twisting of the pan when next used as a meat or grill pan.
Pans which have warped or twisted due to direct heat of a cooking plate will not be exchanged free of charge.
-

Getting to know your oven

Shelf positions

Fig. 2

Your oven has 4 shelf positions. Consult your AEG recipe book for details.

Insert the fat filter

Fig. 3

The fat filter is used for **open roasting** and **grilling** of any kind. The fat filter absorbs airborne fat preventing it from reaching the fan.

How to insert the fat filter

Hold the fat filter by the small handle (**fig. 5**) and insert the 2 clips into the slots in the back panel over the fan. Make sure that the fat filter covers the fan opening completely.

How to select the different cooking methods

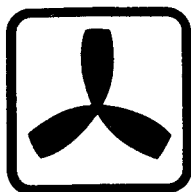

1. Ventitherm fan cooking

Select  on the selector switch (**fig. 1/D**) and the required temperature on the oven temperature control (**fig. 1/E**) if you want to use the oven as a Ventitherm. For detailed information on the Ventitherm cooking method consult your AEG recipe book.

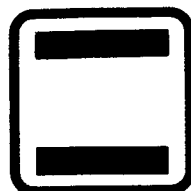

2. Conventional electric cooking

If you want to use the oven as a conventional electric oven select  on the selector switch (**fig. 1/D**) and the required temperature on the oven temperature control (**fig. 1/E**). For further information consult your AEG recipe book.

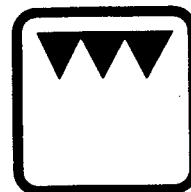

3. Grilling

Traditional grilling

Your oven features an advanced grilling method, allowing you to grill with the oven door CLOSED — substantially reducing energy consumption.

How to use the Grill

1. **Insert the fat filter**
2. Select the grill symbol  on the selector knob (**fig. 1/D**) and the highest setting on the variable control (**fig. 1/E**).
3. Pre-heat grill for 3—5 minutes if you wish to seal the food quickly.
4. Place the food **on the reversible wire shelf in the enamelled pan**.
5. Position the pan on the shelf position required.
6. **Close the oven door.**
7. To reduce the heat select a lower setting.
8. To use the grill pan handle see **fig. 10, 11 and 12**. The handle must be removed during grilling to prevent heat damage.

How to select the different cooking methods

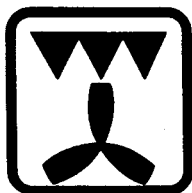

4. Infra-therm roasting/grilling

This replaces the rotisserie in your oven and is suitable for joints and poultry, weighing 1 kg (2 lb) or more.

Insert the fat filter

Select  on the cooking method selector (fig. 1/D) and the required temperature on the oven temperature control (fig. 1/E).

This is an excellent way of roasting meat if you prefer to let the fat and juices drip away from the joint. The Infratherm roasting method gives an all-over brown and crispy finish to the joint similar to grilling.

The joint is placed on the wire shelf and the shelf is positioned on the second or third runner from the bottom depending on the size of joint. For small joints (1½ Kg) use the third, for large joints use the second.

The enamelled pan is positioned on the first runner from the bottom and potatoes can be roasted in the pan at the same time allowing 1¼—1½ hours cooking time.

For cooking times and temperatures consult your AEG recipe book.

The oven door is closed during infra-therm roasting/grilling.

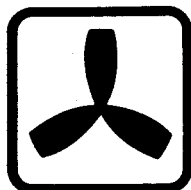

5. Hot air grilling

This method is ideal for grilling toasted snacks, chicken portions, chops, steaks, kebabs etc. without turning the food.

Insert the fat filter.

Select  on the cooking method selector (fig. 1/D) and between 200—250 °C on the oven temperature control (fig. 1/E).

Food is placed directly in the enamelled pan.

The baking sheets available as an optional extra are also well suited for this type of grilling if you want to grill on 2 or 3 levels simultaneously.

For easy cleaning the baking sheets and the enamelled pan can be lined with non-stick parchment.

For further details consult your AEG recipe book.

The oven door is closed during hot air grilling.

To switch off the oven

Turn the cooking method selector (fig. 1/D) and the oven temperature control (fig. 1/E) anti-clockwise to the "off" position.

Defrosting with Ventitherm

Containers

Use ovenproof containers covered with a lid or foil.

Shelf position

Use 2nd from bottom and place containers either in the enamelled pan or on a wire shelf.

Temperatures and times

Ready-made meals are thawed and heated through on 200 °C.

Ready-to-cook frozen foods are thawed and cooked between 170—200 °C depending on the type of food.

Times depend on the type of food to be thawed and the temperature selected.

The values given in the chart are guidelines only and may have to be adjusted accordingly.

To switch on the oven

Turn the cooking method selector (**fig. 1/D**) to symbol  and the oven temperature control (**fig. 1/E**) to the required temperature.

Food	Temperature °C	Time hours/mins.	
Ready-made meals (1—4 portions)	200	0.40—0.50	thawing and heating ready to serve
Small cakes without cream fillings or toppings (in foil)	200	0.15—0.20	ready to serve
Large cakes without cream fillings or topping (in foil)	200	0.30—0.45	ready to serve
Un sliced bread in foil (approx. 450 g/1 lb)	200	0.15 + 0.30 at room temperature	ready to serve
Bread rolls	200	0.15 + 0.30 at room temperature	ready to serve
Fruit, e.g. 300 g strawberries, raspberries (in covered container)	200	0.15 + 0.15 at room temperature	ready to serve
Ready-to-cook foods (e.g. pizza, pies)	200	0.45—1.00	ready to serve
Uncooked joints (e.g. 1½ kg)	180—200	2.00—3.00 depending on type of meat	thawed and cooked

Preserving with Ventitherm

Important

Use only bottling jars with rubber seals and glass lids.

Do not use jars with screw tops, bayonet clips or tins. For best results hygienic handling and good quality fresh foods are essential.

Up to six 1—1½ litre jars can be placed in the oven.

Shelf position

Slide the enamelled pan onto the 2nd runner from the bottom and place jars, leaving a space between each, onto it.

The jars should be of the same size and should be filled with the same amount and contents. Make sure that the tops are firmly clipped to the jars. Stand a cup of hot water in the pan to maintain the necessary moisture in the oven.

Close the oven door.

To switch on the oven

Select symbol  on the cooking method selector (fig. 1/D) and 160°C on the oven temperature control (fig. 1/E).

Fruit

Watch the contents of the jars until bubbles form in the first jar (approx. 35—45 minutes for 1 litre jars, approx. 45—60 minutes for 1½ litre jars).

Switch off the oven and leave the jars in the closed oven for a further 30 minutes. For soft fruit, e.g. strawberries, allow only 15 minutes.

Getting to know the electronic clock

The 24-hour electronic clock features a minute minder, automatic STOP and START/STOP facilities which can be used for the automatic cooking area and the oven either individually or together at the same time.

Before selecting an automatic STOP or START/STOP on the clock, the oven and/or cooking area has to be switched on.

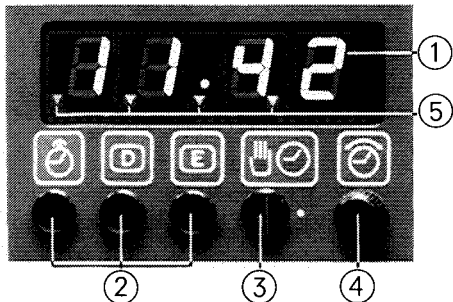



The times are set by pressing the relevant button 2 while at the same time turning control knob 4.

While you are making your selection the display 1 gives you a constant read-out of your selection.

After you have made your selection the display reverts to the time of day.

What the symbols mean



Push buttons with symbols 2



-  To set the minute minder
-  To set the cooking time (duration)
-  To set the cooking end

Symbols on change-over switch 3

The change-over switch is used:





To switch from manual operation to time controlled cooking:

Switch position for **manual** operation:   

Switch position for **time controlled cooking**:   

Symbols on display 1

The indicator symbols "▼" 5 enable you to check your selections:

-   = Automatic indicator flashes: you can make your selections for time controlled cooking
-   = Time controlled cooking selected: red triangle is illuminated
-  = Indicator symbol 5 is illuminated when one of the buttons is pressed and time is being selected and for as long as time controlled cooking is in progress.

To correct or cancel an entry

The time selected can be altered at any time by pressing the relevant button and turning control knob 4.

To cancel the minute minder press the relevant button while at the same time turning control knob 4 until 0.00 is shown on the display.

To cancel an automatic STOP or a selection with a delayed START simply return the cooking Duration to 0.00.

How to use the electronic clock



To re-set the clock

After a power cut the display flashes "00.00" and the cooker cannot be used until the time of day has been set on the clock. How to do this see page 7 "Before using the cooker for the first time".

How to use the minute minder

The minute minder operates independently from the automatic timer control facility. It incorporates an audible signal to remind you that a selected time has elapsed without influencing any selection made on the oven. You can select from 1 minute to 5 hours and 59 minutes.

The minute minder is set as follows:

1. Press button  .
The display will show "0.00" and indicator symbol "▼".
2. At the same time turn control knob 4 until the required time is shown on the display (e.g. 5 minutes). Release button  . The display will revert to the time of day and indicator symbol "▼" is illuminated.

When the selected time has elapsed the indicator symbol "▼" goes out and you will hear an audible signal which will switch off automatically after approx. 3 minutes. To switch this off manually press any of the buttons.

To check on remaining time:

Press button  . The remaining time is shown on the display. Release the button and the display reverts to the time of day.

How to select automatic STOP and START/STOP

General

The oven and/or automatic cooking area can be programmed to switch "off" or "on and off" automatically.

You can select a cooking Duration of 5 hours and 59 minutes within a 23 hour and 59 minute period.

To select an automatic STOP

1. Switch on the oven and/or automatic cooking area.
2. **Set the change-over switch 3 to time controlled cooking.**
The automatic indicator "▼" starts to flash.
3. **Select Duration.**

Press button  at the same time turning control knob 4 to select the required cooking time.

Release button  . The display reverts to the time of day. The indicator symbols "▼" are illuminated.

How to use the electronic clock

To select an automatic START/STOP

1. Switch on the oven and/or automatic cooking area.
2. **Set the change-over switch to time controlled cooking.**
The automatic indicator "▼" begins to flash.
3. **Select Duration.**
Press button **D** at the same time turning control knob 4 to set the required cooking time. Release button **D** and the display reverts to the time of day. The indicator symbol "▼" above **D** is illuminated.
4. **Select Cooking End**
Press button **E** and the display will show the cooking end. The indicator symbol "▼" is illuminated.

Example

It is 9.00 hours. You have selected a cooking time of 45 minutes. If you press button **E** the display will show 9.45. You can now alter the cooking end by turning control knob 4 to any time you wish the food to be ready (e.g. 12.00 hours). As soon as the required cooking end appears on the display release button **E** and the display reverts to the time of day. Symbols above **E** and **D** are illuminated.

According to our example the oven and/or automatic cooking area would switch on at 11.15 and switch off at 12.00 hours.

To check remaining Cooking Duration

During time controlled cooking you can check the remaining cooking time by pressing button **D**. The display will show you the remaining cooking time.

To check the Cooking End

By pressing button **E** the display will show you the time the oven and/or automatic cooking area are going to switch off.

Switch off

At the end of the elapsed duration the oven and/or automatic cooking area will switch off automatically and you can hear an audible signal which will switch off after approx. 3 minutes. To switch the signal off manually, press any of the buttons. The indicator symbols for **D** and **E** go out.

Important

After time-controlled cooking return the cooker control knobs to the "off" position and set the change-over switch to the hand symbol. The automatic indicator stops flashing and the cooker is ready for manual use.

Using the warming drawer

Drawer slides

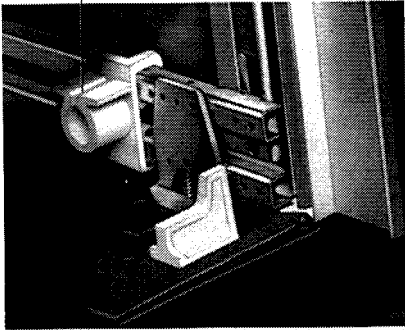

To switch on, open the drawer and press the button on the left-hand side in the drawer frame.

The yellow pilot light glows whilst the warming drawer is in operation. To switch off, release the depressed button.

Removing the warming drawer

- Pull the drawer forward as far as possible.
- Lift up the drawer slightly and remove from the drawer slides at an angle.
- When replacing the drawer make sure the 2 plastic drawer slides are at the front.
- Hold the drawer at an angle and locate the 2 holding pins on either side of the drawer into the slots of the drawer slides (see illustration above).
- Lower drawer to horizontal position, check correct positioning of pins in plastic drawer slides and push to close.

Cleaning and maintenance

General

Always switch off the cooking areas and the oven and let them cool down before cleaning. Never use abrasive cleaners or scouring powders, bleach and stain removers.

Never place aluminium foil over the cooking areas.

Vitramic Hob

Ceramic surfaces require regular care and cleaning although they are easier to clean than your "old cooking areas".

To keep your hob in good condition, please follow the instructions below:

1. For normal to heavy soilage, clean the hob after **each** use with a clean damp cloth or kitchen roll and the AEG cleaner "Stahl-fix". Rub over the hob well and rinse thoroughly with a clean damp cloth or kitchen roll. Polish only with a soft clean cloth.

2. After heavy use of the hob clean as above (1) and use the AEG Cleaner/Conditioner "Cera-fix" or "Collo-profi" daily. For normal use of the hob this should be conditioned at least once a week to ensure the long lasting and good looks of the hob.

Put 3 to 7 drops onto a cold hob surface. Rub and clean with soft kitchen roll and polish off all residue with a clean, damp soft kitchen roll. Polish with a dry clean cloth. This cleaner/conditioner can also be used for light soilage on the hob surface as described above. The above cleaners are available from the AEG Spare Parts department.

Soften boiled over food by leaving a damp cloth on the deposits, then remove deposits carefully using a glass scraper.

3. Mineral deposits present in hard water and food may cause discolouration in the form of grey, blue or mother of pearl stains which appear to be in the surface. Clean such discolourations while the cooking area is still warm (not hot). Use "Stahl-fix" as under point (1) and "Cera-fix" or "Collo-profi" as under point (2).

Warning

DO NOT scatter sugar or allow sugar solutions (jam, jelly etc.) to settle on the hob surface, as permanent damage may occur. If sugar or sugar solutions are accidentally spilled, **remove immediately** — while still hot, with a razor blade, in a patent holder (no detergent!). To clean the hob proceed as under (1).

DO NOT allow plastic materials to melt on the surface. Should this happen, proceed as for sugar above.

DO NOT use abrasive cleaners or scouring pads.

DO NOT slide pans across the surface as this may eventually lead to scratching, making cleaning of the hob more difficult and may even result in permanent stains.

DO NOT use the hob as a chopping board as this may scratch the surface.

DO NOT use oven cleaners or mix household detergents as they may have an adverse effect on the hob surfaces.

Recommended Cleaners "Stahl-fix" for normal or heavy soilage, "Cera-fix" or "Collo-profi" for light soilage and conditioning. These are available from AEG Spare Parts department, "Stahl-fix" E-No. 022 300 702, "Collo-profi", "Collo-profi" set consisting of "Collo-profi" glass scraper and polishing cloth E-No. 661 908 626, and "Cera-fix" 022 300 703.

A razor blade in a patent holder held at an angle of 30° can be used to remove stubborn soilage. This is also available from Spare Parts department — E-No. 298 001 273.

Cleaning and maintenance

Cleaning of the oven

Before cleaning switch off the oven and allow it to cool down. For best results the oven should be cleaned after each use as food deposits will dry or bake on when the oven is used again.

Never use an abrasive such as wire wool, or scouring powder. The following can be used depending on the degree of soilage:

1. A damp cloth and mild detergent.
2. Cream cleaners such as "Jif" and a cloth.

3. Oven cleaners such as "Ovenpad" or "Kleenoff". Do follow the manufacturers instructions on the cleaning materials you use carefully.

For cleaning of painted surfaces, glass, plastic and catalytic liners use mild detergent only. The grill element can be removed for cleaning purposes.

The following parts can be removed for cleaning: oven door, shelf supports, rear panel, grill element, fan, fat filter and vapour guard.

Removing the oven door for cleaning

For thorough cleaning the oven door should be removed. Proceed as follows:

1. Open the door and unlock safety catches on both sides of the door. Using a coin (**fig. 6**) give the locks holding the catches a quarter turn (90 degrees) in clockwise direction.
2. Close the door approximately halfway to the stop position.

3. Press the door slightly forward and lift off (**fig. 7**). **Do not lift door by the handle.**
4. To replace the door, reverse this sequence. Remember to lock the safety catches by returning them to their original position (quarter turn anti-clockwise).

Oven interior light

During cleaning, the oven interior can be illuminated. To switch on the oven light turn the cooking method selector to the symbol .

Cleaning the fat filter

The fat filter should be cleaned after **every** use. To remove filter, hold it by the handle and lift upwards. Place the fat filter in a saucepan, add approx. 2 tbsp. of automatic washing powder or dishwasher powder and cover filter with water. Bring to the boil and

leave to soak for approx. 30 mins or longer depending on the degree of soiling. Rinse filter in clear water and dry. For light soilage wash in a 65°C dishwasher programme. See page 12 for details on how to insert the fat filter.

Cleaning and maintenance

Removing the rear panel

Remove the screws and push the panel up to unhook and remove. To replace the rear panel hook it on to the brackets at the top first (fig. 8/arrows) and then replace the screws.

Removing the fan

Remove the nut (fig. 9) by turning it **clockwise** and remove the fan.
Clean the fan with hot soapy water.
Replace the fan and fasten the nut by turning it anti-clockwise.

Removing the shelf supports

The shelf supports can be removed for cleaning. They are hooked into the side of the oven. Pull the shelf supports, at the bottom, slightly away from the side of the oven and unhook first the front then the back of the shelf support.
Re-assemble in reverse order.

Catalytic liner set to help keep the oven cleaner

An optional catalytic set is available consisting of two side panels and one rear panel which replaces the existing one.

Cleaning and maintenance

These liners help to keep the oven cleaner as they clean themselves to a great extent during roasting and baking at temperatures above 200°C.

As cleaning may be improved by exposure to a higher temperature it may be necessary to run the oven at 250°C for 1 or 2 hours per week.

Before carrying out such a heat cycle remove all oven equipment and make sure that you have cleaned the unlined surfaces to prevent any soil from baking on.

For isolated stubborn stains use a soft brush and very hot soapy water. Never use abrasive cleaners or scouring powders.

Vapour vent guard

The vapour vent guard is to be fitted over the vapour vent on the left of the oven door handle as per illustration.

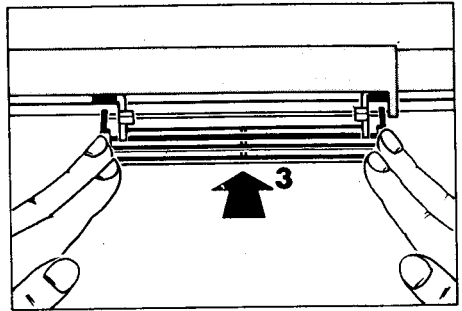
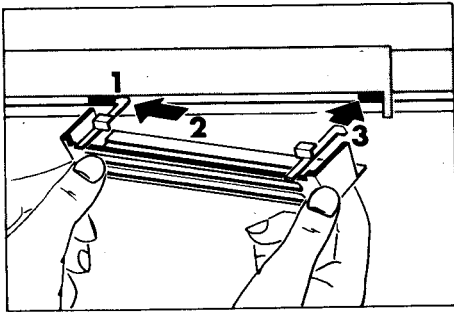

Optional extras

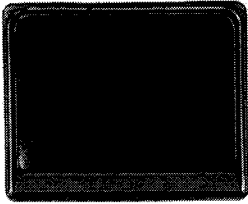

Baking sheet
E-No. 611 899 193



Reversible wire shelf
E-No. 661 238 780

Catalytic Panel Set KSF 4
E-No. 611 899 794

Important facts on installation

Electrical connection of the cooker

This is a job for a qualified and approved electrician. The appliance is rated for 240 volts single phase AC and must be permanently connected.

All instructions given by the Electricity Board must be followed carefully when connecting the cooker to the mains supply.

Make sure that the plastic laminate or the furniture veneer are processed with a heat-resistant glue (heat-resistant up to 150 °C). Unsuitable plastic laminate or glue which is not heat-resistant may cause deformation of the plastic laminate, or loosening, in particular from the corner trims of the furniture units.

Installation

The appliance must be installed in such a way that it can be easily disconnected before servicing, e.g. by removing the fuses or by operating the automatic cut-out. Sufficient cable should be left to enable the appliance to be moved for servicing whilst still connected to the mains supply.

After installation there must be no access to live parts.

The connection chart is illustrated on the back panel of the appliance.

1. Loosen screws and turn lid of terminal box sideways as illustrated.
2. Pass cable through the grommet in the back panel and the cable clamp.
3. Connect the wires to the terminals in accordance with the diagram. Ensure that links are correctly positioned between terminals (5 way terminal block). The length of the earth conductor must be adequate to ensure that in case of the cable clamp breaking, the earth wire is subject to mechanical strain only after the live wires.
4. Tighten the cable clamp screw.
5. The length of the mains cable should be adequate to enable the appliance to be removed for easy servicing (approx. 1.5 metres or 5 ft.).

6. Turn lid of terminal box back to position and re-tighten screws.
7. When pushing the cooker into its final position make sure that the mains cable is neither kinked nor trapped under the appliance.

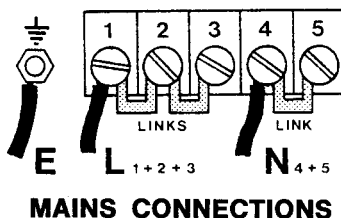

If you think your cooker is not working properly

The indicator lights do not work

- Check whether the operating sequence has been fully carried out.
- Check whether the fuses in the fuse box are in good working order.

The oven does not heat up

- Have you selected the cooking method and the temperature?

The oven or the automatic cooking area does not work.

- Did you forget to turn the change over button of the automatic timer back to the manual symbol  after time controlled cooking? See also pages 17, 18 and 19.

The oven or the automatic cooking area does not accept any selection you wish to make.

- Check whether 00:00 are flashing on the clock display. In this case set the time of day on the clock (see page 7).

- The audible signal on the clock does not switch off?
- The clock display is not illuminated but the pilot light is on?
- Wrong figures appear on the clock display?
- Did you make a mistake in your selections or was the electrical supply shut off for a short time?
- Switch off the electrical supply to the cooker, wait 30 seconds and switch on again.
- Set the clock to the time of day (see page 7).

The oven interior light has failed

1. Disconnect the fuses in the fuse box.
2. Turn protective cover for the oven light on oven roof anti-clockwise to remove.
3. Replace bulb (40 W heat-resistant to 300°C). Bulbs are not covered by warranty and are not free of charge.

Important

- Please make sure that you are not able to rectify the fault yourself prior to calling a service engineer in connection with one of the aforementioned problems, as the cost involved will have to be passed on even during the warranty period.
- Therefore, follow the instructions in this booklet and the information contained in the lead-in pages and the recipes in our cookery guide carefully.
- We are continually working on new developments and we ask for your understanding that we reserve the right to change specifications concerning technical aspects, colours and design without prior notice.

Service

Should you be unable to locate the cause of a problem in spite of the above check-list please contact your AEG Service Department quoting the E- and F-number which you will find on the right of the oven frame. For easy reference transfer the numbers to the back of this booklet.

These numbers enable the service department to prepare as far as possible any spare parts required to rectify the fault on first call.

The dishwasher complies with the radio interference requirements of the EEC Directives 82/499/EEC and the standard EN 60555 part 1—3/DIN VDE 0838 part 1—3, June 1987.

When calling our service department please quote the following numbers:

E-No.:

F-No.:

