

ÖKO-LAVAMAT 84749 update

The environmentally friendly washing machine

User information



Dear Customer,

Please read this instruction book carefully before using the appliance. Please ensure you fully understand the safety instructions on the first pages of this instruction book.

Retain the instruction book for future reference, and pass it on to any future owners.



The warning triangle and / or key words (**Warning!**, **Caution!**, **Important!**) give information that is important for your safety or the function of the appliance is highlighted. It is imperative that this information is observed.



1. This symbol guides you step by step through the operation of the appliance.

2. ...



This symbol gives you additional information and practical tips on using the appliance.



Tips and information about the economical and environmentally friendly use of the machine are marked with the clover leaf.

In the event of a malfunction, these operating instructions contain information on how to remedy these faults yourself. See the section "What to do if ..."

Printed on recycled paper.

Thinking ecologically means acting ecologically ...

Contents

Operating Instructions	6
Safety	6
Disposal	8
Environmental tips	8
Description of the Appliance	9
Front view	9
Detergent dispenser drawer	9
Control Panel	10
Programme selector	10
Programme Option Buttons	12
Programmable functions	13
Consumption Values and Programme Times	14
Wash Time Display	14
What does "UPDATE" mean?	15
Anti-flood Aqua Control + Aqua Alarm	15
Before the first wash	16
Preparing for a wash cycle	16
Sorting and preparing the washing	16
Types of washing and care symbols	17
Detergents and Conditioners	18
Which detergent and conditioner?	18
How much detergent and conditioner?	18
Water softening	18
Running a washing cycle	19
Brief instructions	19
Setting the wash programme	19
Changing Spin Speed /selecting RINSE HOLD	20
Setting the delay timer/soaking duration	21
Opening and closing the door	22
Loading the washing	22
Adding detergent/conditioners	23
Starting the wash programme	24

Washing Programme Progress	25
Washing cycle complete/Removing the washing	26
Programme Tables	27
Washing	27
Separate Rinse/Conditioning/Starching/Treating	28
Separate Spinning	28
Maintenance and Cleaning	29
Control panel	29
Detergent Dispenser Drawer	29
Washing Machine Drum	30
Main door	30
Cleaning the drain pump	31
What to do if...	32
Trouble Shooting	32
If the washing results are not satisfactory	36
Carrying out an emergency emptying	37
Emergency unlocking of the door	38
Additional rinse cycle (RINSE+)	39
Water cooling	40
Additional rinse cycle and water cooling	40
Variomatic spin	41
Programme Protection	42
Child Safety Feature	43
Installation and connection instructions	44
Installation Safety Precautions	44
Installation of the appliance	45
Transporting the appliance	45
Remove transport packaging	45
Installation-Site preparation	47
Installation on a Suspended Floor	47
Levelling the appliance	48

Electrical Connection	49
Water connection	51
Water pressure	51
Inlet Hose Connection	52
Water Drainage	53
Pump head of greater than 1m	54
Technical Data	55
Dimensions	55
Warranty conditions	56
Index	58
Service & Spare Parts	59

Operating Instructions



Safety

The safety features of AEG electrical appliances comply with accepted technical standards and the German Appliance Safety Law. However, we also consider it our obligation as a manufacturer to inform you about the following safety information.

Prior to initial start-up

- Observe the **"Installation and Connection Instructions"** in this instruction book.
- If the appliance is delivered in the winter months and temperatures are below freezing: Store the washing machine at room temperature for a few hours before putting it into operation.

Intended Use

- The washing machine is only intended for washing normal domestic washing. If the appliance is used for any other purpose or incorrectly operated, the manufacturer accepts no liability for any damages which may result.
- It is dangerous to alter the specifications or attempt to modify this product in any way.
- Only use detergents which are suitable for automatic washing machines, and follow the recommendations of the detergent manufacturer.
- Garments which have been in contact with flammable solvents should not be washed. Also bear this in mind when washing pre-cleaned washing.
- Do not use the washing machine for dry-cleaning.
- Dyes and bleaching agents may only be used if specifically permitted by the manufacturer of these products. We cannot be held liable for any damages.
- This appliance must be connected to the cold water supply only.
- Damage due to frost is not covered by the guarantee. If the washing machine is located in a room in which below freezing temperatures may occur, emergency emptying must be carried out (see "carrying out an emergency emptying").

Child Safety

- Packaging materials (e.g. films, styrofoam) can be dangerous for children. There is a risk of suffocation! Keep all packaging well away from children.
- This appliance is designed to be operated by adults. Do not allow children to tamper with the controls or play with the appliance.
- Pets and children have been known to climb into washing machines. Please check the drum before use.
- When disposing of the appliance, cut off the mains cable, and destroy the plug. Disable the door lock to prevent young children being trapped inside.

General Safety

- Repairs to the washing machine must only be carried out by qualified personnel. Repairs carried out by inexperienced persons may cause injury or serious malfunctioning. Contact your local AEG Service Force Centre.
- Never operate the washing machine if the mains cable is damaged or the control panel, work top or base area are damaged allowing internal components to be accessible.
- Switch off the appliance and isolate from the mains supply before carrying out any cleaning or maintenance work.
- Do not use the mains cable to pull the plug out of the socket.
- Adapters and extension cables must not be used. **There is a danger of overheating!**
- Do not clean the washing machine with a water jet. There is a danger of electrical shock!
- During high temperature wash programmes, the glass of the door may become hot. Do not touch!
- Allow the water to cool down before cleaning the drain pump, carrying out emergency emptying or opening the door in an emergency.
- Small animals/pets can chew on power cables and water hoses. This can cause the danger of an electrical shock to the animal and water damage to the appliance and property. Keep small animals away from the appliance.



Disposal

Packaging

Dispose of the packaging material correctly. All packaging materials used are environmentally friendly and can be disposed of without any danger to the environment.

- Plastic parts can be recycled and are identified as follows:
 - >PE< for polyethylene, e.g. the outer covering and the bags in the interior.
 - >PS< for polystyrene, e.g. padding (always CFC-free)
 - >POM< for polyoxymethylene, e.g. plastic clips
- Cardboard packaging is manufactured from recycled paper and should be deposited in the waste paper collection for recycling.

When disposing of the washing machine!

Cut off the mains cable and destroy the plug. Disable the door catch to prevent young children becoming trapped inside. Use an authorised disposal site.



Environmental tips

- It is not usually necessary to Pre-wash or Soak normally soiled washing. This will save you detergent, water and time (and protect the environment as well).
- It is more economical to wash full loads.
- When washing small loads, use half to two thirds the recommended quantity of detergent.
- Pre-treat stains, if necessary, and then wash at a lower temperature.
- It can be possible to wash without fabric softeners, if clothes are dried in a tumble dryer, as this can give soft and fluffy results.
- In hard water areas, the use of a water softening agent can reduce the amount of detergent necessary. See manufacturer's recommendations.

Description of the Appliance

Front view

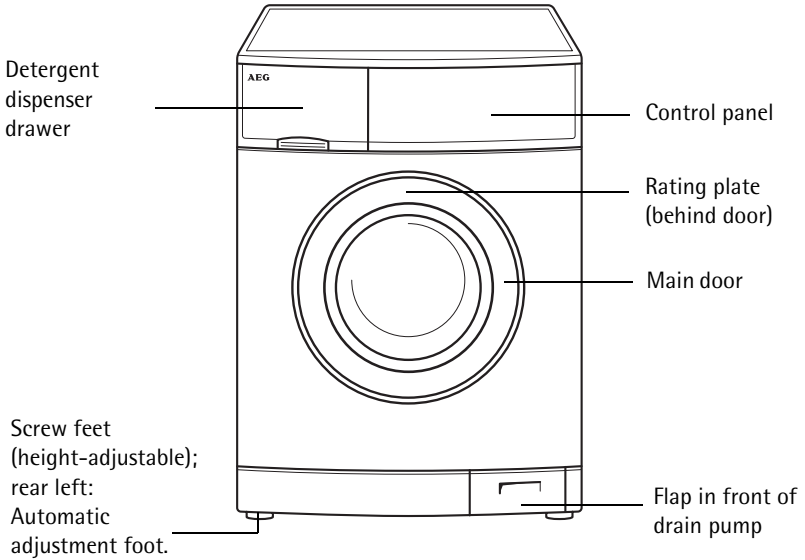

Detergent dispenser drawer

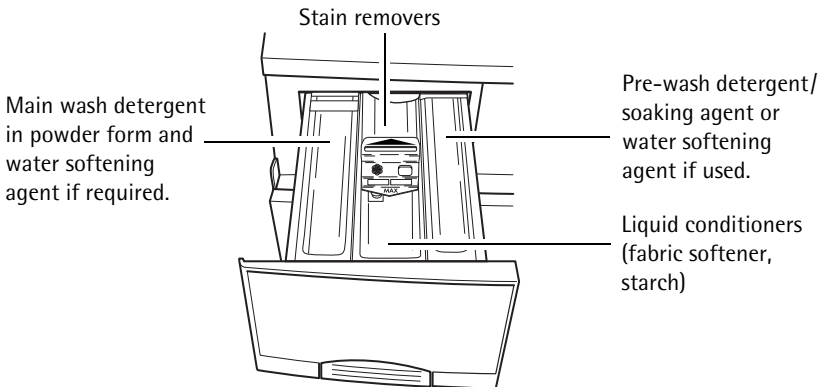

Control Panel

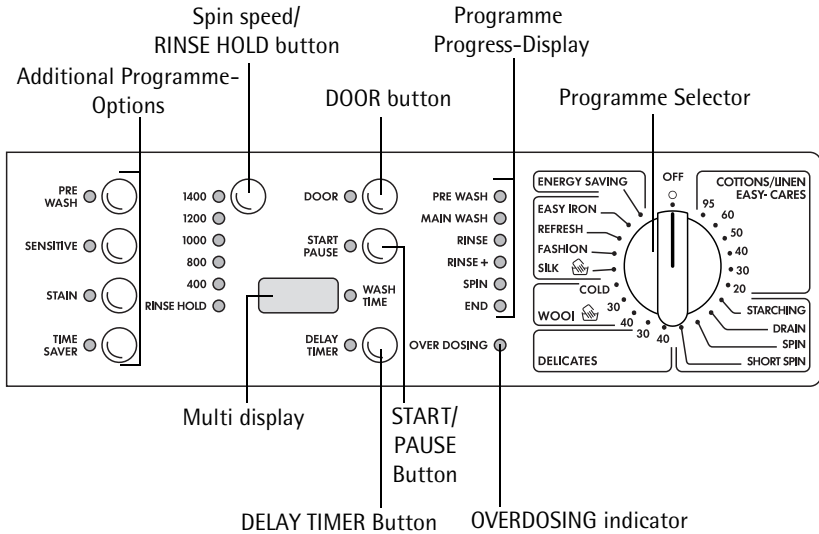

Programme selector

The programme selector is used to select the type of wash cycle (for example, water level, drum movement, number of rinses, spin speed) and the water temperature according to type of washing.

OFF

Switches the washing machine off; at all other positions the machine is ON.

To amend programme settings selected by mistake, turn the programme selector to OFF. This restores the original settings.

COTTONS/LINEN, EASY-CARES

Wash programme from 20 °C to 95 °C, generally used for all Cottons/ Coloureds (cotton/linen), Easy-Cares (mixed fibres, for example cotton/ polyester) and synthetics. The programme is suitable for different fabrics and loads. Once a temperature has been set, the machine will automatically select a COTTONS/LINEN or EASY-CARES programme as appropriate. If there are Easy-Cares only, do not exceed the load weight of 2.5 kg, to avoid excessive creasing.

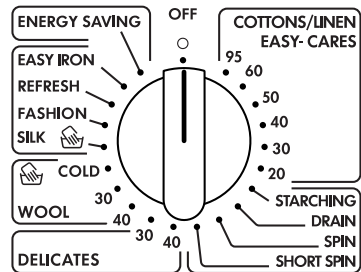

STARCHING

Separate starching, separate conditioning, separate treatment of damp clothes (1 rinse, liquid conditioner is washed in from the  compartment, spin).

This can also be selected if a separate rinse is necessary. In this case, you do not need to add anything to the compartment.

DRAIN

To drain the water after a rinse hold (without spinning).



The effect of Rinse Hold is that the washing is left to soak in the last rinse water; it is not spun.

SPIN

Draining the water after a Rinse Hold and Spin, or separate spinning of hand-washed Cottons/Coloureds and Easy-Cares.

SHORT SPIN

Draining the water after a Rinse Hold and Short Spin, or separate Short Spin of delicate fabrics (delicates, woollens) at low spin speed.

DELICATES

Wash programme for Delicates at 30 °C or 40 °C.

WOOL /  (Handwash)

Wash programme (cold, up to 40 °C) for machine-washable wool and hand-washable wool items carrying the  care symbol. (Handwash).

SILK /  (Handwash)

Wash programme at 30 °C for hand and machine-washable silk.



Since silk is a very delicate material, we recommend washing only one item at a time (if possible), and never washing together with other, rougher fabrics. An even more gentle treatment can be selected for extremely delicate silk items, using the TIME SAVER button.

FASHION

A special care programme at 40 °C, for modern textiles such as Viscose, Modal, Cupro, Lyocell, providing gentler handling than the DELICATES programme, and a stronger cleaning action than the Handwash programme.

REFRESH

A special programme of approx. 20 minutes at a maximum temperature of 30 °C for quick washing of items such as sports wear, which have been worn once and are only slightly soiled.

EASY IRON

Wash programme at 40 °C for easy-care items which, after this programme, are to be ironed only lightly or not at all.



ENERGY SAVING

Special energy and water saving programme at about 60 °C, for lightly to normally soiled Cottons/Coloureds (cotton/linen), with extended wash time.

Programme Option Buttons

The programme option buttons are used to adapt the programme to suit the degree of soiling of the wash. The additional PRE-WASH and STAIN options are not needed for normally soiled washing. The different functions can be combined together, depending on the programme.

PRE-WASH (Pre-wash/Soaking)

Cold pre-wash before the main wash cycle, which follows automatically. The DELAY TIMER button changes Pre-wash to warm soaking.

SENSITIVE

Special extra programme function that gives an extra rinse along with better fabric care (less drum movement). This is ideal when frequent washes are necessary, for example in cases of sensitive skin. RINSE+ can still be selected as well.

STAIN

For heavily soiled or stained washing. (In-wash stain treatment products (powder or tablets) are washed in at the optimum time as the programme progresses.)



With the WOOL/🧤 (Handwash) setting, the additional programme option buttons cannot be used.

TIME SAVER

Shortened wash programme for lightly soiled washing, consisting of three stages with the COTTONS/LINEN, EASY-CARES programme and two stages with the other programmes.

Programme	Length of programmes		
	Without TIME SAVER	With TIME SAVER	
		Button pressed once	Button pressed twice
COTTONS/LINEN, EASYCARES at 60 °C	119 mins.	91 mins.	63 mins.
Other programmes, for example DELICATES at 30 °C	68 mins.	52 mins.	-

Programmable functions

The programmable functions Extra Rinse (RINSE+), Water Cooling and Variomatic Spin are described in the Chapter "What to do if ...".

Consumption Values and Programme Times

The following table gives the values for selected programmes under standard conditions. Consumption values depend on the selected programme settings (optional functions), washing type and quantity, water pressure, such as water inlet temperature, water hardness, room temperature or detergent used, etc. The tables do, however, give a helpful guide for normal household use.

Programme Selector (Temperature)	Type of material	Load in kg	Water in litres	Energy in kWh	Time in minutes
ENERGY SAVER ¹⁾	Cotton	6	44	1.05	120
COTTONS/LINEN, EASY-CARES 95	Cotton	6	50	2.05	148
COTTONS/LINEN, EASY-CARES 60	Cotton	6	50	1.08	119
COTTONS/LINEN, EASY-CARES 40	Cotton	6	58	0.66	116
COTTONS/LINEN, EASY-CARES 60 TIME SAVER (press once) ¹⁾	Synthetics	3	56	0.95	91
COTTONS/LINEN, EASY-CARES 40 TIME SAVER (press once) ¹⁾	Synthetics	3	52	0.55	88
COTTONS/LINEN, EASY-CARES 40 TIME SAVER (press twice)	Synthetics	3	50	0.58	59
DELICATES 30	Synthetics	3	56	0.36	68
WOOL /  (Handwash) 30		2	42	0.18	35

1) **Note:**Programme setting for testing in accordance with or in support of Standard EN 60 456 and IEC 60 456.

Wash Time Display



The multi-display indicates the estimated duration, in minutes, of the programme. These timings are estimates and can vary. During the programme countdown, the remaining time can be recalculated due to any of the following: incoming water temperature, type and quantity of laundry, out of balance spin detection and foam detection.



What does "UPDATE" mean?

The control system of your washing machine is fully electronic. The software which determines this control system can be reprogrammed. If a further improvement to washing technology is introduced by AEG, then your machine can be updated. The cost of the UPDATE will be advised at the time of the request.

For further information regarding this, please contact the AEG Customer Care Department.

Anti-flood Aqua Control + Aqua Alarm

The inlet hose has a mechanical built in safety device. In the event of the filling hose failing, the safety device will automatically shut off the water supply.

In the event of a leak within the machine the float switch, which is mounted in the base of the appliance, will operate the drain pump and an audible signal will be heard

The system will operate as long as the appliance is connected to the mains electricity supply, even if the programme selector is in the off position.

Before the first wash

-  Run a washing programme without laundry (selecting COTTONS/LINEN, EASY-CARES 95, with half the normal amount of detergent). This removes any residues from the drum which may have been left during manufacturing.

Preparing for a wash cycle

Sorting and preparing the washing

- Sort the washing according to care symbols (see Section "Types of washing and care symbols").
- Empty out the pockets.
- Remove metal objects (such as paper clips, safety pins, etc.).
- To avoid damage and tangling: close zips, button pillow-cases and duvet covers, tie together loose tapes and strings (for example on aprons).
- Turn items with double-layered fabrics inside out (sleeping bags, anoraks, etc.).
- Knitted coloured fabrics such as woollens and other materials with decorations or jewellery should also be turned inside out.
- Wash small, delicate items (such as baby's socks, tights, bras, etc.) in a washing net, cushion cover with a zip or in large socks.
- Special care must be taken with net curtains. Remove metal or plastic rollers liable to snag or tie the curtains up in a net or bag. We cannot accept liability for any damage.
- Coloured and white washing should not be washed together in the same cycle. Otherwise, whites can discolour or turn grey.
- New coloured garments often have excess dye. It is better to wash these items separately for the first time.
- Mix large items with smaller ones. This gives more effective washing and distributes items better during the spin cycle.
- Shake out the washing before loading it into the washing machine.
- Separate items from one another before placing in the drum.
- Pay attention to care advice such as "Wash separately" or "Wash separately several times"!

Types of washing and care symbols

Care symbols help you to choose the correct wash programme. Washing should be sorted by type and according to care symbols. The temperatures indicated on the care symbols are the maximum wash temperatures.

Cottons

Cotton and linen items with this care symbol are not sensitive to machine washing or high temperatures. The COTTONS/LINEN, EASY-CARES programme is suitable for this type of washing.

Coloureds

Cotton and linen items with this care symbol are not sensitive to machine washing. The COTTONS/LINEN, EASY-CARES programme is suitable for this type of washing.

Easy-Care washing

Materials such as fine cotton, cotton-blend fabrics and synthetics with these care symbols require a gentler machine wash. The COTTONS/LINEN, EASY-CARES and EASY-IRON programmes are suitable for these types of washing.



Delicates

Materials such as layered fibres, microfibres, synthetics and net curtains with this care symbol require careful handling. The DELICATES programme is suitable for this types of washing.

Viscose

Modern fabrics such as Viscose, Cupro, Lyocell, Modal, etc. need particularly careful handling. The FASHION programme is suitable for this type of washing.

Wool, silk and especially sensitive washing

Fabrics like wool, wool blends and silk with these care symbols are particularly sensitive to machine washing. The WOOL/ (Handwash) and SILK/ (Handwash) programmes are suitable for these types of fabrics.

Important! Materials with the care symbol  (Do not wash) should not be washed in the washing machine.

Detergents and Conditioners

Which detergent and conditioner?

Use only detergents and conditioners which are suitable for use in automatic washing machines. Always follow the manufacturer's instructions.

How much detergent and conditioner?

The required quantity depends upon:

- the extent of soiling of the washing
- the hardness class of the mains water
- the amount of washing



Should the detergent manufacturer not specify the dosage quantity for less than full loads, reduce the detergent accordingly: For a half load reduce the quantity by 1/3. For a small load or an EASY IRON programme reduce the quantity by 1/2.

Observe the instructions for use and dosing provided by the detergent and conditioner manufacturer.

Water softening

For medium to high water hardness (hardness class II upwards) a water softening agent can be used. Refer to the manufacturer's instructions. Then always add the appropriate amount of detergent (underdosing) for hardness class I (soft). Your local Water Authority can advise you on the hardness of the water in your area.

Water hardness details

Hardness class	Water hardness in °dH (German hardness scale)	Water hardness in ppm (Parts Per Million)
I - soft	0 - 7	to 125
II - medium hard	7 - 14	125 - 250
III - hard	14 - 21	250 - 375
IV - very hard	greater than 21	greater than 375

Running a washing cycle

Brief instructions

A washing cycle consists of the following steps:

1. Set the appropriate washing programme:
 - Set the programme and temperature using the programme selector
 - Select any programme options if required
2. Change the Spin Speed/select RINSE HOLD as necessary.
3. Set the DELAY TIMER as required.
4. Open the door and load the washing.
5. Close the door.
6. Add detergent/conditioner.
7. Start the washing programme by pressing the START/PAUSE button.

After the washing programme has ended:

Important! If the washing cycle has ended with a Rinse Hold, select DRAIN, SPIN or SHORT SPIN before opening the door.

8. Open the door and remove the washing.
9. To switch off the washing machine, turn the programme selector to OFF.

Setting the wash programme

i See "Programme tables" for a suitable programme, correct temperature and possible options to suit the type of washing.

1. Set the programme selector to the desired wash programme with the desired temperature. The expected duration of the programme selected is displayed in the multi display in minutes.

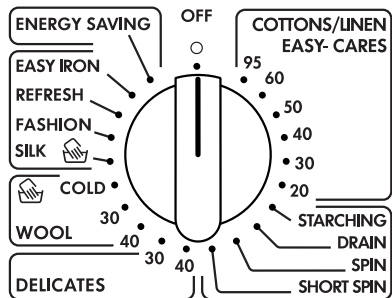

2. If required, select the programme option(s). The indicator display of the selected option lights up.
- To change the option press another button.
 - To cancel a selection, press the button again.





Changing Spin Speed /selecting RINSE HOLD

-  To change Spin Speed for the final spin (if necessary)/select RINSE HOLD:
Press the Spin Speed/RINSE HOLD button as often as necessary, until the indicator light for the desired speed (or Rinse Hold) is lit.
If RINSE HOLD is selected, the washing is left to soak in the last rinse water, without spinning.



-  If the Spin Speed is not changed, the final spin is automatically adjusted to suit the washing programme:

- COTTONS/LINEN, EASY-CARES 1400 revolutions per minute
- ENERGY SAVING 1400 revolutions per minute
- DELICATES 1200 revolutions per minute
- WOOL /  (Handwash) 1200 revolutions per minute
- SILK/  (Handwash) 1200 revolutions per minute
- FASHION 1200 revolutions per minute
- EASY IRON 1200 revolutions per minute

The speed of intermediate spins depends on the selected programme, and cannot be changed.

Setting the delay timer/soaking duration

Delay timer

The DELAY TIMER button makes it possible to delay the start of a wash programme by 1 to a maximum of 19 hours.

1. Select wash programme.
2. Press DELAY TIMER button.



When start delay has been set, the DELAY TIMER display lights up.

Depress the DELAY TIMER button until the desired start delay appears, e. g. *12h* for a 12 hour delay to the start of the programme. If *19h* is displayed and the button is pressed again, then the delay timer is cancelled. The duration of the set wash programme will now appear in the display in minutes, e. g. *120*.

The set delay timer can also be cancelled if the programme selector is set to the OFF position.

3. Press START/PAUSE button.





Soaking duration

While pressing the PRE WASH button and the DELAY TIMER button, the duration of soaking can be increased in hourly steps up to a maximum of 19 hours.

1. Press and hold the PRE WASH button.
2. Press DELAY TIMER button.
Soaking is set, the WASH TIME indicator illuminates.
The soaking time is now increased by 1 hour.
3. By repeated pressing of the DELAY TIMER button, the soaking times can be increased in steps of an hour.
The WASH TIME and DELAY TIMER displays light up.

Opening and closing the door

-  Open: Press the DOOR button. The door springs open.
-  Close: Press the door firmly closed.



When the unit is switched on, the DOOR display shows whether the door can be opened:

- green: The door can be opened (not when programming is activated, see the section "Programme protection" for details)
- off: Door cannot be opened
- red: Door is open

Loading the washing

-  For maximum loads, see "Programme Tables".
For hints on how to prepare washing correctly, see "Sorting and preparing the washing".

-  **1.** Sort and prepare the washing by type and colour.
- 2.** Open the door: press the DOOR button. The door springs open.
- 3.** Load the washing.

Important! Do not trap washing when closing the door. The fabrics and the machine could be damaged.

- 4.** Close the door firmly.

Adding detergent/conditioners

i For instructions concerning detergent and conditioners, see Section "Detergents and conditioners".

- 1.** Open the detergent dispenser additives drawer : press the flap so as to be able to grasp the handle (1), and pull out the drawer (2).

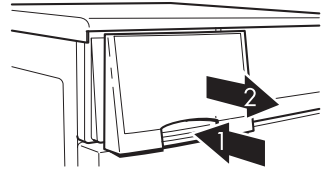

- 2.** Add the detergent/conditioners.

Compartment for in-wash stain treatment powders/tablets

(for use with the STAIN programme option only)

Compartment for main wash detergent

(If you use a water softener and need the right-hand compartment for the Pre-wash/Soaking agent, add the water softener to this compartment with the main wash detergent.)

Compartment for liquid conditioners

(softeners, finishers, starch)

Important! Do not fill the compartment past the MAX mark. If required, dilute concentrated fluids up to the MAX mark, and dissolve powdered starches.

Note: A small amount of water remaining in the liquid conditioner compartment is normal and does not affect the wash results.

Compartment for Pre-wash detergent/ Soaking agent

(for the PRE-WASH/SOAKING programme options only)
or for water softener

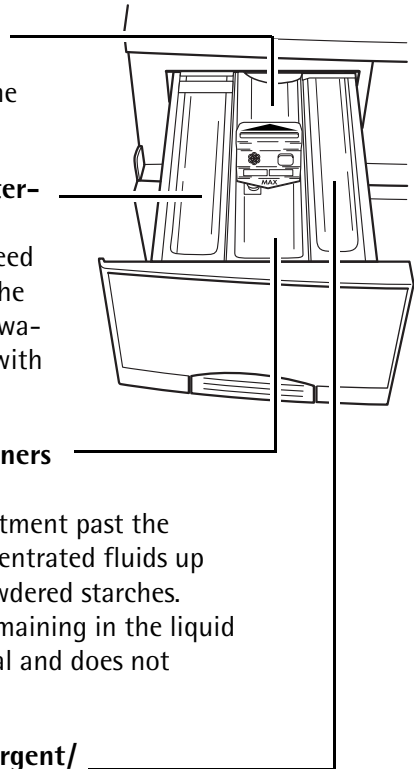

3. Push the detergent dispenser drawer in fully

If using liquid detergents/tablets:

Add liquid detergent or tablets in the quantity recommended by the washing detergent manufacturer. Add liquid detergent with the dosage container provided by the detergent manufacturer.

Starting the wash programme

 1. Check that the water tap is open.

2. Starting the wash programme: Press the START/PAUSE button.

The wash programme is started or starts after the end of the time delay set.



 If the DOOR indicator flashes red when pressing the START/PAUSE button, then the door is not properly closed. Press the door firmly closed and press the START/PAUSE button again.

If a delay start has been set:

The delay time set counts down, the remaining time until the start of the programme is displayed in the multi display (in hours remaining). During this time, you can add washing or change the delay time or cancel it.

- Adding washing: Press the START/PAUSE button. The door can be opened. Then close the door and press the START/PAUSE button again.
- Changing or stopping the delay time: Press the DELAY TIMER button until the desired time is displayed; when the duration of the programme is displayed (e. g. 120 minutes) the wash programme starts immediately.

Washing Programme Progress

Programme progress display

Prior to the start, the programme steps chosen are displayed by the Programme progress display. During the washing programme the current programme step is displayed.

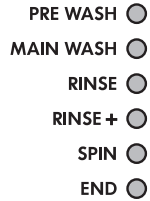

Multi display

The expected time remaining (in minutes) up to the end of the programme is shown in the Multi display.



The multi display indicates the estimated duration, in minutes, of the programme. These timings are estimates and can vary according to incoming water temperature, type and quantity of laundry, out of balance spin detection and foam detection. During the programme countdown, the remaining time can be recalculated due to any of the above factors.

Changing spin speed

During the washing programme, the spin speed can still be changed or RINSE HOLD can be set. Other settings cannot be changed.



Stopping the programme

Turn the programme selector to OFF in order to stop the washing prematurely.



The programme can be interrupted at any time with the START/PAUSE button and can be continued again by pressing this button again.

Washing cycle complete/Removing the washing

Once the wash programme has come to an end the END indicator illuminates on the programme progress display.

- If the EASY IRON programme was selected, and anti-crease phase of approximately 30 minutes follows the programme end. Here, the multi display shows the remaining time and the END indicator illuminates. During the anti-creasing phase, the door can be opened at any time and the washing can be removed.
- If RINSE HOLD was selected, the display next to the START/PAUSE button flashes.

-  **1.** After a rinse hold, the water must first be pumped out:
- Either press the START/PAUSE button (water is pumped out and the washing is spun according to the completed programme; using the RINSE HOLD spin speed button, it is possible to change the spin speed during spinning),
 - or
 - Turn the programme selector to DRAIN and press the START/PAUSE button (the water is pumped off without spinning),
 - or
 - Turn the programme selector to SPIN or SHORT SPIN and press START/PAUSE button (water is pumped out and the washing is spun accordingly).

After the end of this programme step, the END display lights up.

2. Open the door.

As soon as the indicator next to the DOOR button is green, the door can be opened (not if programme security is activated. For details see „Programme security,,).

3. Remove the washing.

4. Turn the programme selector to OFF.

5. After washing, pull the washing detergent drawer out a little so that it can dry out. Leave the door ajar so that air can circulate in the drum.



If the OVERDOSING indicator illuminates, then too much detergent was used in the washing programme just completed. Observe the dosing recommendations of the detergent manufacturer as well as the load quantity for the next wash.











Important: If the washing machine is not to be used for a long period: Close the water tap and disconnect the washing machine from the electricity mains. (Anti-flood: The Aqua Control with Aqua Alarm does not function if the power supply is interrupted).

Programme Tables

Washing

The tables do not show all the possible settings, only those most likely to be selected for everyday purposes.

Type of washing, Care symbol	Max. Load (Dry weight) ¹⁾	Programme selector Temperature [in °C]	Possible Programme options or functions
Cottons/Coloureds ²⁾ 	6 kg	ENERGY SAVING 60	PRE-WASH SENSITIVE STAIN TIME SAVER
Cottons/Coloureds 	6 kg	COTTONS/LINEN, EASY- CARES 20 to 95	PRE-WASH SENSITIVE STAIN TIME SAVER
	3 kg	REFRESH 30	
Easy-Cares ²⁾ 	3 kg	COTTONS/LINEN, EASY- CARES 20 to 60	PRE-WASH SENSITIVE STAIN TIME SAVER
	1 kg	EASY IRON ³⁾ 40	PRE-WASH STAIN TIME SAVER
	3 kg	REFRESH 30	
Delicates 	3 kg (or 15-20m ² net curtains)	DELICATES 30, 40	PRE-WASH STAIN TIME SAVER
	3 kg	FASHION 40	
Wool/ Handwash 	2 kg	WOOL/  COLD to 40	
Silk/Handwash 	1 kg	SILK/  30	TIME SAVER

1) A 10 litre bucket holds around 2.5kg of dry clothes (cotton).

2) Programme settings for testing in accordance with or in support of standard EN 60 456 and IEC 60 456, are described in the Chapter "Consumption Values and Programme Times".

3) Creasing can be largely avoided by keeping wash loads under 1 kg (roughly 5 to 7 easy-care men's shirts).

Separate Rinse/Conditioning/Starching/Treating

Type of washing	Max. load (dry weight)	Programme selector
Cottons/Coloureds	6kg	STARCHING
Wool/Handwash	2kg	STARCHING + TIME SAVER button

Separate Spinning

Type of washing	Max. load (dry weight)	Programme selector
Cottons/Coloureds	6kg	SPIN
Easy-Cares	3kg	
Delicates	3kg	SHORT SPIN
Wool/Handwash	2kg	
Silk	1kg	

Maintenance and Cleaning

Control panel

Important! Do not use household furniture polish or abrasive cleaners to clean panel and operating parts.

- ☞ Wipe over the operating panels with a damp cloth. Use warm water.

Detergent Dispenser Drawer

The detergent dispenser drawer should be cleaned from time to time.

- ☞ 1. Pull the detergent dispenser drawer out as far as it will go.
- 2. Remove the detergent dispenser drawer by pulling sharply.
- 3. Take the conditioner insert out of the middle compartment.
- 4. Clean the conditioner insert under running water.

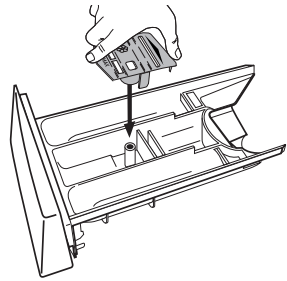

- 5. Clean the separate compartments with warm water. It is best to use a flat brush.

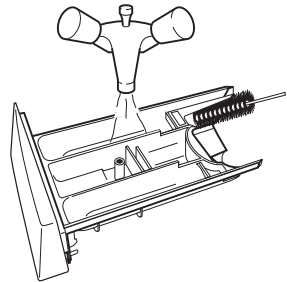

- 6. Push on the conditioner insert as far as it will go so that it is securely in place.

7. Use a brush to clean the entire compartment area of the washing machine, particularly also the nozzles on the top side of the compartment.

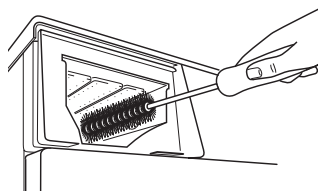

8. Set the detergent dispensing drawer into the guide tracks and push it in.

Washing Machine Drum

The washing machine drum is made from rust-free stainless steel. Any objects left in the laundry which are likely to rust can stain the drum.

Important! Do not clean the stainless steel drum with descaling agents containing acids, scouring agents containing chlorine or iron, or steel wool. Your local AEG Service Force Centre has suitable agents available.

- ☞ Remove any rust stains on the drum using a stainless steel cleaning agent.

Maintenance Wash

- i** With the use of low temperature washes it is possible to get a build up of residues inside the drum. We recommend that a maintenance wash be performed on a regular basis.

To run a maintenance wash:

The drum should be empty of laundry.

- ☞
 1. Select the hottest cotton wash programme.
 2. Use a normal measure of detergent, must be a powder.

Main door

- ☞ Regularly check to see if there are deposits or foreign objects in the rubber seal behind the door, and remove them.

Cleaning the drain pump

Paper clips, nails and so on can sometimes get into the washing machine with the washing and remain in the drain pump casing. Fluff and strands of fabric can gather on these items and block the drain pump. Therefore the drain pump should be cleaned at least once a year.



Warning! Switch off the washing machine and pull out the mains plug before cleaning the drain pump.

1. First carry out emergency emptying (see section "Carrying out emergency emptying").
2. Place a towel on the floor in front of the cover of the drain pump. Surplus water may flow out.
3. Unscrew the drain pump cover anti-clockwise and pull it out.

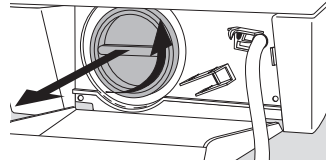

4. Remove any foreign bodies from the pump housing.

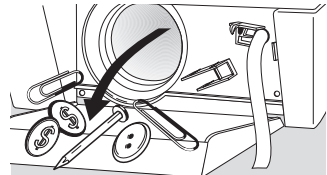

5. Replace the cover. Insert the webs on the cover laterally into the guide slots and screw on the cover securely clockwise.

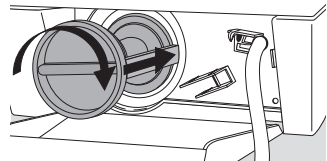

6. Close the emergency emptying hose and place it in the holder.
7. Close the flap.

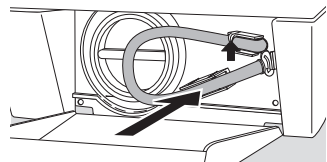

What to do if...

Trouble Shooting

If the appliance is not working correctly, please carry out the following checks before contacting your local Service Force Centre. Important: If you call out an engineer to a fault listed below or to repair a fault caused by incorrect use or installation, a charge will be made even if the appliance is in guarantee.

- If the fault code **E1** oder **E2** is shown in the multi-display, you may be able to remedy the fault yourself (see the Fault table below).





After clearing the fault, press the START/PAUSE button. If the fault code is shown again, contact your local Service Force Centre.

- For all other faults displayed in the multi-display, please contact your local AEG Service Force Centre, stating the fault code.

Problem	Possible cause	Remedy
Washing machine does not work.	The mains plug is not plugged in.	Plug in the mains plug.
	The house fuse has blown.	Replace the fuse.
	Door is not properly closed.	Close door; Lock must engage audibly .
	START/PAUSE button has not been pressed long enough.	Keep the START/PAUSE button pressed until the programme starts.
Door cannot be closed.	Child safety feature is switched On.	Cancel child safety feature (see section „Child safety feature“).
Water is not entering. Error code E1 appears.	Water tap is closed.	Open water tap.
	Filter in the socket of the inlet hose connection is blocked.	Close water tap. Disconnect hose from water tap, remove filter and clean under running water.
	Water tap is blocked with limescale or is faulty.	Check the water tap and have it repaired if necessary.

Problem	Possible cause	Remedy
Washing machine vibrates during operation or is unstable.	Transport packaging has not been removed.	Remove transport packaging according to setting up and connection instructions.
	The machine is not level.	Adjust the feet according to installation and connection instructions.
	There is very little washing in the drum (e.g. only a dressing gown).	This does not affect the operation of the machine.
	Water could not be fully pumped out before spinning because the drain hose is kinked or water pump is blocked.	Check the drain hose and remove any kink if necessary, or clean the drain pump and, if necessary, remove foreign bodies from the pump housing.
Excessive foaming during the main wash.	Probably too much detergent has been used.	If may be necessary to reduce the amount of detergent used. Follow the detergent manufacturer's recommendations.
Water leaks out of the washing machine.	The screw Connection on the inlet hose is leaking.	Tighten the inlet hose screw connection.
	Drainage hose is leaking.	Check the drain hose and replace it if necessary.
	The drain pump cover is not correctly close.	Close cover correctly.
	Washing is caught in the door.	Stop the programme, remove the washing caught in the door. Restart the programme.
	The emergency emptying hose is not correctly closed or is leaking.	Close the emergency emptying hose (see section „Carry out emergency emptying“). Call your local Service Force Centre if the emergency emptying hose is leaking.

Problem	Possible cause	Remedy
The drain pump runs constantly - even when the appliance is switched off.	The Aqua Control anti-flood system has been activated.	Close the water tap, remove the mains plug and inform your local Service Force Centre.
Fabric softener was not rinsed in, compartment  for conditioners is filled with water.	The insert in the compartment for conditioners is not correctly attached or is blocked.	Clean the detergent dispenser drawer and attach the conditioner insert correctly.
Washing is heavily creased.	Probably too much washing has been put in drum.	Pay attention to the maximum load quantity (see programme tables). In the case of easy-care fabrics select the EASY IRON programme.
The washing is not sufficiently spun. Water is left in the drum. Error code  appears	Drain hose is kinked.	Remove the kink.
	Maximum pump height (emptying height 1 m from base surface of the appliance) is exceeded.	Contact your local Service Force Centre. For pumping heights over 1 m a conversion kit is available as a special accessory.
	Drain pump is blocked.	Switch off appliance and pull out the mains plug. Clean the drain pump.
The door cannot be opened when appliance is switched on.	At the siphon connection: Siphon is blocked.	Clean siphon.
	The door is locked for safety reasons (DOOR display is OFF).	Wait until the DOOR display lights up green.
Remnants of detergent are building up in the detergent drawer.	The programme security function is On.	Cancel programme security (see section „Programme protection“).
	Water tap is not fully opened.	Open water tap fully.
	The inlet hose filter in the coupling of the inlet hose at the tap is blocked.	Close the water tap. Unscrew the inlet pipe from water tap and from the appliance and clean the filter.

Problem	Possible cause	Remedy
The rinse water is cloudy.	The cause is probably a detergent with a high silicate content.	No negative influence on the rinse results, use a liquid detergent if necessary.
When pressing a programme option button the corresponding display does not light up.	The selected programme option cannot be combined with the set programme.	Make another selection.
Programme cycle display flashes constantly.	Programme security is switched On; the programme selector has been moved during the wash cycle.	Turn programme selector to its original position (see „Programme security“).

If the washing results are not satisfactory

If the washing turns greyish and limescale deposits are present in the drum

- Insufficient detergent has been added.
- Incorrect detergent was used.
- Stains were not pre-treated.
- Programme or temperature was not set correctly.
- If using modular detergents, the individual components were not used in the correct ratio.

If there are still grey stains on the washing

- Soiled garments with ointments, grease or oils were washed with insufficient detergent.
- The temperature selected for the wash was too low.
- A frequent cause is that fabric softener - particularly a concentrated one - has come into contact with the washing. Wash out these types of stains as soon as possible and use the fabric softener carefully.

If after the last rinse foam is still visible

- Modern detergents can still cause foam in the final rinse cycle. However, the washing is still sufficiently rinsed.

If there are white residues on the washing

- These are insoluble contents of modern detergents. They are not the result of an insufficient rinse. Shake out the washing or brush it off. Turn the washing inside out before washing it. Review your choice of detergent and if necessary use liquid detergent.

Carrying out an emergency emptying

- If the washing machine no longer pumps out the water, emergency emptying must be carried out.
- If the washing machine is located in a room in which below freezing temperatures might occur, emergency emptying must be carried out. Furthermore: unscrew the inlet hose from the water tap and drain off the water. Empty the drainage hose.



Warning! Switch off the washing machine and pull out the mains plug prior to performing emergency emptying.

Warning! The water, which flows out of the emergency emptying hose can be hot. First allow the water to cool down before you carry out the emergency emptying.

 1. Have a flat container on hand to catch the water.

2. Pull down the flap in the right corner of the base strip outwards and pull it off.

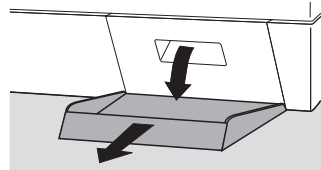

3. Remove the emergency emptying hose from its holder.

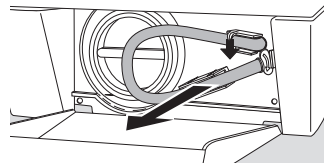

4. Place the container under the hose.

5. Detach the plug of the emergency emptying hose by turning it anticlockwise and pull it out.

The water runs out. Depending on the amount of water, it may be necessary to empty the collecting vessel several times. To do this, close the emergency emptying hose temporarily with the plug.

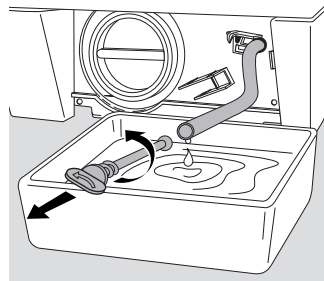

Discard the water from the container, replace it under the emergency emptying hose and remove the plug from the hose.

When the water is completely drained:

6. Push the plug securely into the emergency emptying hose and turn it clockwise to secure it.
7. Replace the emergency emptying hose in its holder.
8. Put on the flap and close.

Emergency unlocking of the door

If the door cannot be opened, it can be opened using the emergency unlock feature.



Warning! If it is necessary to unlock the door manually, always ensure that the washing machine has been disconnected from the electricity supply first.

1. If water can be seen in the window of the door, first perform an emergency emptying (see section "Carry out emergency emptying").
2. Pull down the flap in the right hand side of the base panel.
3. Turn the rotary knob clockwise using a coin. The door springs open.

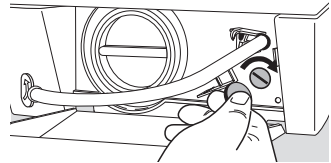

Additional rinse cycle (RINSE+)

The washing machine is set for very economical water consumption. However, for people who suffer from allergies to detergents, it can be helpful to rinse with extra water.



If this function is selected, an extra rinse is added to the COTTONS/LINEN, EASY-CARES, EASY IRON and DELICATES programmes. When delivered, the machine is not set for the additional rinse.

To set the additional rinse:



1. Turn the programme selector to SHORT SPIN.
2. Press and hold the SENSITIVE button for at least 5 seconds. When the button has been pressed for 5 seconds, RINSE+ flashes on the Programme Progress display for 5 seconds.
3. While RINSE+ is flashing, release the SENSITIVE button. When it stops flashing, the additional rinse is set. It remains set until cancelled again. When the additional rinse has been set, the RINSE+ indicator flashes on the display before the programme starts and during the additional rinse.
4. If you want to check whether the additional rinse has been set:
 - Turn the programme selector to SHORT SPIN.
 - Push the SENSITIVE button briefly.

If RINSE+ flashes on the Programme Progress display, the additional rinse has been set.

To cancel the additional rinse:



1. Turn the programme selector to SHORT SPIN.
2. Press and hold the SENSITIVE button for at least 5 seconds. As soon as the button is pressed, RINSE+ flashes on the Programme Progress display. After 5 seconds, RINSE+ stops flashing and remains lit continuously for another 5 seconds.
3. While RINSE+ is lit continuously, release the SENSITIVE button. When RINSE+ is no longer lit, the additional rinse has been cancelled.



An additional rinse cycle increases water consumption and the programme duration.

Water cooling

It may be necessary to cool the water before draining, to prevent thermal damage to the plastic outlet pipes.



The water is cooled before draining out at the end of the main wash (by adding cold water).

(This setting is only available with the COTTONS/LINEN, EASY-CARES programmes, with temperatures over 40 °C.)

When the washing machine is delivered, water cooling is not set, except for the SENSITIVE programme option.

To set the water cooling function:



1. Turn the programme selector to SHORT SPIN.
2. Press and hold the PRE-WASH button for at least 5 seconds. When the button has been pressed for 5 seconds, MAIN WASH flashes on the Programme Progress display for 5 seconds.
3. While MAIN WASH is flashing, release the PRE-WASH button. When it stops flashing, water cooling has been set. The function remains set until cancelled again.
4. If you want to check whether water cooling has been set:
 - Turn the programme selector to SHORT SPIN.
 - Press the PRE-WASH button briefly.If MAIN WASH flashes on the Programme Progress display, water cooling has been set.

To cancel water cooling:



1. Turn the programme selector to SHORT SPIN.
2. Press and hold the PRE-WASH button for at least 5 seconds. As soon as the button is pressed, MAIN WASH flashes on the Programme Progress display. After 5 seconds, MAIN WASH stops flashing and remains lit continuously for another 5 seconds.
3. While MAIN WASH is lit continuously, release the PRE-WASH button. When MAIN WASH is no longer lit, water cooling has been cancelled.



The water cooling function raises water consumption and extends programme time.

Additional rinse cycle and water cooling

You can combine the additional rinse and water cooling functions. Set the two functions as described under "Additional rinse cycle" and "Water cooling".

Variomatic spin

The variomatic spin is integrated into the final spin. The washing does not cling to the side of the drum as much and can be taken out more easily. This can be set with the COTTONS/LINEN, EASY-CARES programmes.

To set Variomatic Spin:

1. Turn the programme selector to SHORT SPIN.
2. Press and hold the STAIN button for at least 5 seconds.
When the button has been pressed for 5 seconds, the END light flashes on the Programme Progress display for 5 seconds.
3. While END is flashing, release the STAIN button. When it stops flashing, Variomatic Spin has been set. It remains set until cancelled again.
4. If you want to check whether Variomatic Spin has been set:
 - Turn the programme selector to SHORT SPIN.
 - Press the STAIN button briefly.If the END light flashes on the display, Variomatic Spin is set.

To cancel Variomatic Spin:

1. Turn the programme selector to SHORT SPIN.
2. Press and hold the STAIN button for at least 5 seconds.
As soon as the button is pressed, the END light flashes on the Programme Progress display. After 5 seconds, the END light stops flashing and remains continuously lit for another 5 seconds.
3. While END is continuously lit, release the STAIN button. When END is no longer lit, Variomatic Spin has been cancelled.

Programme Protection

To protect a programme setting against unintentional changes or tampering (for example, programme selector turned or buttons pressed accidentally, etc.), set the Programme Protection. This will protect your washing from damage.



The Programme Protection can be set or released at any time while the programme is running.

Setting the Programme Protection:



1. Set the desired programme.
2. Press the START/PAUSE button to start the programme.
3. Press and hold the PRE-WASH and SENSITIVE buttons at the same time, for around 5 seconds. The programme progress display flashes for 5 seconds;
The Programme Protection is now set.



No other settings can be selected as long as the Programme Protection is active. The door cannot be opened with the DOOR button. Also, when the wash cycle is completed, the Programme Protection must be released before the door can be opened.

If one of the buttons is pressed to try to change the setting while the wash programme is running, the programme progress display flashes for 5 seconds.

If the programme selector is turned to try to change the setting, the programme progress display flashes until the programme selector is returned to its original setting. This does not affect the wash cycle.



The programme selector must be at the original position before the Programme Protection can be cancelled.

labelling the Programme Protection:



Press and hold the PRE-WASH and SENSITIVE buttons at the same time, for around 5 seconds. The programme progress display flashes for 5 seconds, then remains lit steadily for 5 seconds. The Programme Protection is now released.

Child Safety Feature

If the child safety feature is set, the door cannot be closed and no washing programme can be started.



Setting the child safety feature

Use a coin to turn the rotary knob on the inside of the door clockwise as far as it will go.

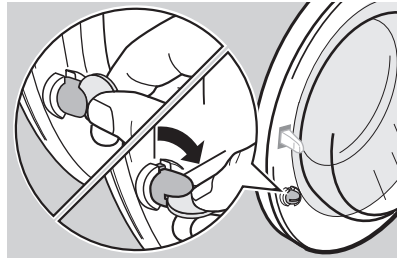

Warning! The rotary knob must not be in a vertical position after adjustment, otherwise the child safety feature is not active. The rotary knob must project as shown in the diagram.

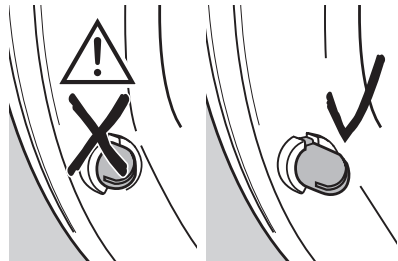

Cancelling the child safety feature



Turn the rotary knob anticlockwise as far as it will go.

Installation and connection instructions

Installation Safety Precautions

- When moving do not tilt the washing machine onto its front or onto its right hand side (viewed from the front). This is to prevent the possibility of the electronic components becoming wet.
- Before installation inspect the machine for transport damage. Do not connect the appliance if it is damaged - contact your retailer.
- Ensure all packaging and transit bolts/bars have been removed, see „Removal of Transit Packaging“. Failure to remove transit bolts/bars may cause serious damage to the appliance or property.
- Always insert the plug into a correctly installed earthed socket.
- Any plumbing work required to install this appliance should be carried out by a plumber or competent person.
- Check that the electricity supply is the same as that indicated on the appliance's rating plate.
- Any electrical work required to install this appliance should be carried out by an electrician or competent person.

Installation of the appliance

Transporting the appliance

- Do not place the washing machine on its front or on its right hand side (viewed from the front). This is to prevent the possibility of the electronic components becoming wet.
- Never transport the unit without the transport packaging and bolts/bars. Do not remove the transport packaging until the appliance is at the installation location. Transporting the unit without the transport packaging can damage it.
- Never lift the appliance by the door.

When transporting the unit with a sack trolley:

- Attach the sack trolley only at the side. The shovel of the sack trolley must not be longer than 24 cm, otherwise the float switch can be destroyed.

Remove transport packaging

Important! It is essential to remove the transport packaging before putting the appliance into operation. Keep all parts of the transport packaging in a safe place for future use.

1. Open both hose holders on the appliance's rear side and remove the hoses and mains cable.

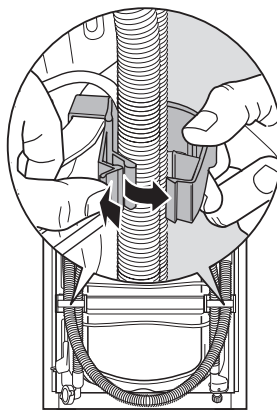

2. Pull both hose holders off the appliance with a strong pull.

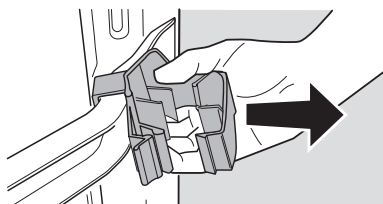

i The special spanner (A) and the caps (B) (2 each) and (C) (1 each) are supplied with it.

3. Remove the screw D, including the compression spring with the special spanner A.

4. Cover the hole with the cap C.

Important! When fitting the plastic caps, press until they snap into the rear panel securely.

5. Remove the two screws (E) with the special spanner (A).

6. Remove the 4 screws (F).

7. Remove the transit bar (G).

8. Screw the 4 screws (F) back in for safe keeping.

9. Close the 2 large holes with the caps (B).

Important! When fitting the plastic caps, press until they snap into the rear panel securely.

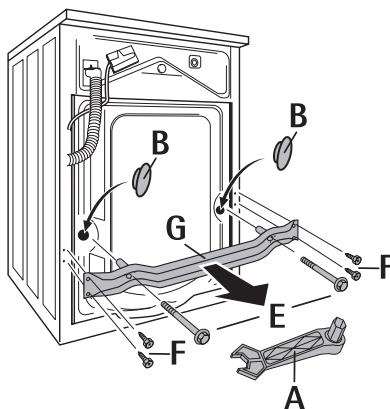
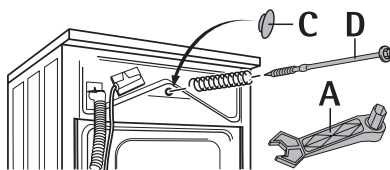

Installation-Site preparation

- The installation surface must be clean, dry and level. Do not install on a deep pile carpet.
- Minor unevenness of the floor surface should never be levelled out by laying pieces of wood, card or similar materials, but should always be compensated for by adjusting the screw feet.
- If the appliance is installed next to a heat source (e.g. cooking appliance), a heat insulating pad (87 x 57 cm) must be placed between the appliance and the heat source.
- Do not install the appliance in locations where the temperature may fall below freezing.
- Please ensure that when the appliance is installed it is easily accessible for the engineer in the event of a breakdown.

Installation on a Suspended Floor

Suspended wooden floors are particularly susceptible to vibration. To help prevent vibration we recommend you place a waterproof wood panel, at least 15 mm thick under the appliance, secured to at least 2 floor beams with screws. If possible install the appliance in one of the corners of the room, where the floor is more stable.

Levelling the appliance

i **Self adjusting foot:** The rear foot of your washing machine is designed like a spring leg. This makes the machine very stable even at high spin speeds.

If the washing machine is still not stable during spinning, proceed as follows:

- 1.** Set the three adjustable feet to the nominal value of 10 mm. Use the supplied spanner.
If the self adjusting foot does not reach the floor:
- 2.** Manually extend the self adjusting foot (rear left) to the required length.
- 3.** Check the appliance is level using a spirit level.

Important! Never use strips or shims of wood or cardboard etc. to compensate for any unevenness in the floor. Always use the adjustable feet.

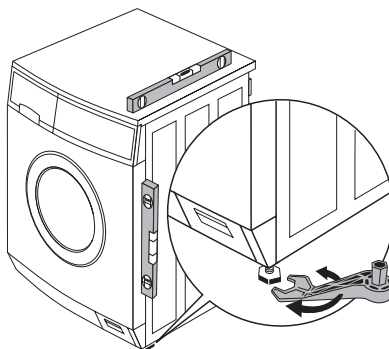

Electrical Connection

Any electrical work required to install this appliance should be carried out by a qualified electrician or competent person.



WARNING – THIS APPLIANCE MUST BE EARTHED.
The manufacturer declines any liability should these safety measures not be observed.

Before switching on, make sure the electricity supply voltage is the same as that indicated on the appliance rating plate.

The rating plate is located at the top of the rim of the open door.

The appliance is supplied with a 13amp plug fitted. In the event of having to change the fuse in the plug supplied, a 13amp ASTA approved (BS 1362) fuse must be used.

Should the plug need to be replaced for any reason, proceed as described below.

The wires in the mains lead are coloured in accordance with the following code:

Green and Yellow:	Earth
Blue:	Neutral
Brown:	Live

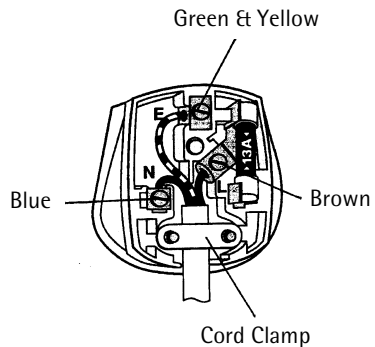
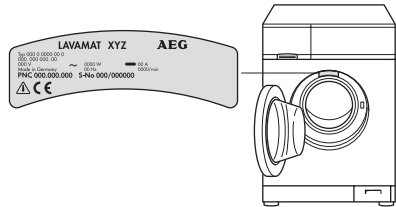

- The wire coloured green and yellow must be connected to the terminal marked with the letter "E" or by the earth symbol \oplus or coloured green and yellow.
- The wire coloured blue must be connected to the terminal "N" or coloured black.
- The wire coloured brown must be connected to the terminal marked "L" or coloured red.
- Upon completion there must be no cut, or stray strands of wire present and the cord clamp must be secure over the outer sheath.



WARNING! A cut off plug inserted into a 13 amp socket is a serious safety (shock) hazard. Ensure that the cut off plug is disposed of safely.

Permanent Connection

In the case of a permanent connection it is necessary that you install a double pole switch between the appliance and the electricity supply (mains), with a minimum gap of 3 mm between the switch contacts and of a type suitable for the required load in compliance with the current electrical regulations.

The switch must not break the yellow and green earth cable at any point.



This appliance is in accordance with the following EU Guidelines:

- Low Voltage Guidelines 73/23 EEC dated 19 February 1973, include Guideline Change Notice 93/68 EEC
- EMC Guideline 89/336 EEC dated 3 May 1989, including Guideline Change Notice 92/31 EEC.

This appliance complies with the requirements laid out in the EEC Directive 76/899.

Voltage 240 V AC: Fuse rating 13 amps

See rating plate for further information.

This appliance meets VDE requirements.

Particular regulations of local electricity authorities must be observed. This appliance conforms to EEC Directive No. 82/499/EWG on radio interference.



WARNING! Repairs to electrical appliances must only be carried out by trained personnel. Improper repairs may lead to serious risks for the user.

Water connection



The washing machine is provided with safety devices preventing back-contamination of the water supply and complies with local water authority requirements.

This appliance is designed to be permanently plumbed into your home's water supply.

Before connecting up the machine to new pipework or to pipework that has not been used for some time, run off a reasonable amount of water to flush out any debris that may have collected in the pipes.

Important!

- Appliances for connecting to cold water must not be connected to hot water.
- Only use new hose sets for the connection.

Water pressure

The appliance is designed to operate within the following water pressure units. Minimum 1 bar (= $10\text{N/cm}^2 = 0.1\text{ Mpa}$), maximum 10 bar (= $100\text{N/cm}^2 = 1\text{ Mpa}$).

- If more than 10 bar: Install a pressure-reduction valve upstream
- If less than 1 bar: Unscrew the inlet hose from the appliance at the inlet solenoid valve and remove the flow regulator (to do this, remove the filter with needle nose pliers and remove the rubber washer behind the filter). Replace the filter.

Inlet Hose Connection

A pressure hose 1.5m in length is supplied.

If a longer inflow hose is required, only a VDE-approved, complete set of hoses with fitted hose screw connections offered by your local Service Force Centre is permissible.

- Hose sets in lengths of 2.2m, 3.5m and 5 m are available for washing machines without Aqua Control.
- Hose sets in lengths of 2.0m, 2.9m and 3.9m are available for washing machines with Aqua Control.

Important! Never cut hoses into pieces in order to extend them!

i Sealing rings are supplied either in the plastic nuts of the hose screw connection or in the enclosed pack. Do not use other seals!

- 1.** Connect the hose with the angled connection to the machine.

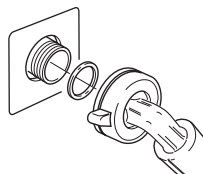

Important!

- Do not lay the inlet hose vertically downwards. Instead, turn it to the right or left as shown in the diagram.
- Tighten firmly to prevent leakage but do not use excessive force.

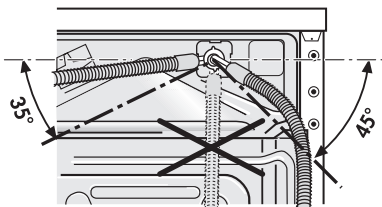

- 2.** Connect the hose with a straight connection to a water tap with a screw thread R 3/4 (inches).

Important! Only tighten the screw connection manually.

- 3.** By slowly opening the water tap before putting the washing machine into operation it is possible to check that the connection is free of leaks.

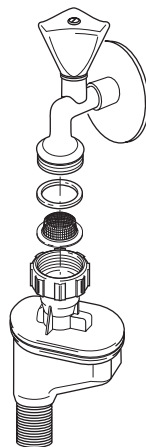

Water Drainage

The appliance drain hose should hook into a standpipe, the hook in the drain hose is formed using the plastic "U-Piece" supplied. The standpipe should have an internal diameter of approximately 38 mm (see diagram) thus ensuring there is an air break between the drain hose and standpipe.

Important! It is essential to lay the drainage hose without kinks.

When discharging into a standpipe ensure that the top of the curve in the hose end is no more than 90 cm (35.4") and no less than 60 cm (23.6") above floor level.

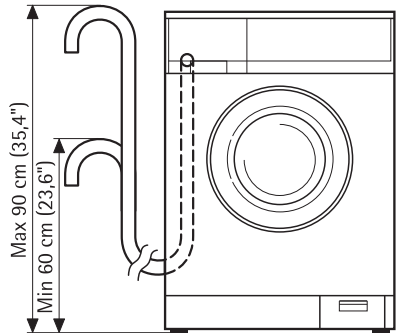

The upright standpipe should have a minimum, length of 30 cm (12") from the bottom of the elbow to the top of the pipe (see diagram). Make sure that it is designed in such a way that the end of the drain hose cannot be covered with water.

Longer drain hoses are available in lengths of 2.7 and 4 metres from your AEG Service Force Centre.

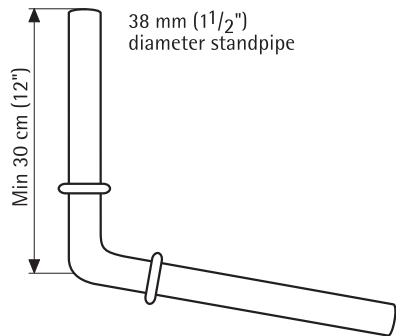

If you intend the drain hose from the washing machine to empty into a sink, make sure that the sink is empty and the plug hose is not blocked. Use the plastic "U-Piece" supplied.

Important! The end of the drainage hose must not be submerged in the pumped-out water. Otherwise, the water could be sucked back into the appliance.

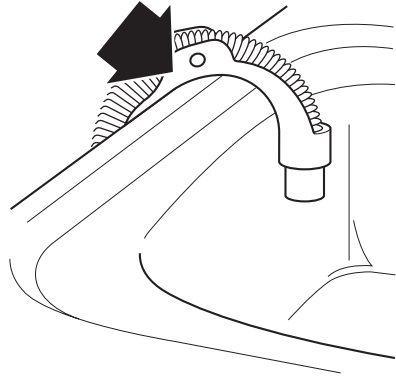

Pump head of greater than 1m

Every washing machine includes a wash water pump for the removal of wash and rinse water, which can pump fluids through the outlet hose up to a height of 1m, measured from the surface on which the machine stands.

For pump heads of greater than 1m please contact your local AEG Service Force Centre.

Technical Data

Height adjustment

Load (depending on programme)

Area of use

Drum spin speed

Water pressure

of about +10/-5mm

up to 6kg

Domestic

see Rating Plate

1-10bar

(=10–100N/cm² = 0.1–1.0MPa)

Dimensions

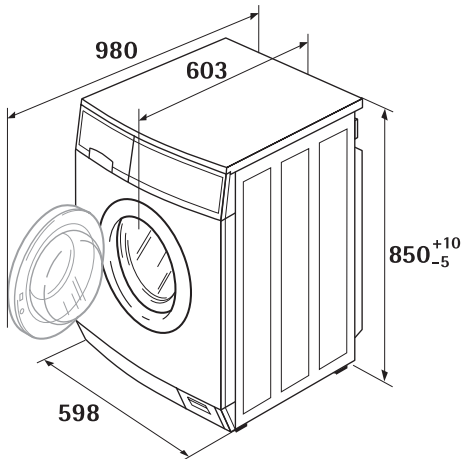

(dimensions in mm)

Warranty conditions

Great Britain

Guarantee Conditions

AEG offer the following guarantee to the first purchaser of this appliance.

1. The guarantee is valid for 12 months commencing when the appliance is handed over to the first retail purchaser, which must be verified by purchase invoice or similar documentation.
The guarantee does not cover commercial use.
2. The guarantee covers all parts or components which fail due to faulty workmanship or faulty materials. The guarantee does not cover appliances where defects or poor performance are due to misuse, accidental damage, neglect, faulty installation, unauthorised modification or attempted repair, commercial use or failure to observe requirements and recommendations set out in the instruction book.
This guarantee does not cover such parts as light bulbs, removable glassware or plastic, dust bags or filters.
3. Should guarantee repairs be necessary the purchaser must inform the nearest customer service office (manufacturer's service or authorised agent). AEG reserves the right to stipulate the place of the repair (i. e. the customer's home, place of installation or AEG workshop).
4. The guarantee or free replacement includes both labour and materials.
5. Repairs carried out under guarantee do not extend the guarantee period for the appliance. Parts removed during guarantee repairs become the property of AEG.
6. The purchaser's statutory rights are not affected by this guarantee.

European Guarantee

If you should move to another country within Europe then your guarantee moves with you to your new home subject to the following qualifications:

- The guarantee starts from the date you first purchased your product.
- The guarantee is for the same period and to the same extent for labour and parts as exist in the new country of use for this brand or range of products.
- This guarantee relates to you and cannot be transferred to another user.
- Your new home is within the European Community (EC) or European Free Trade Area.
- The product is installed and used in accordance with our instructions and is only used domestically, i. e. a normal household.
- The product is installed taking into account regulations in your new country.

Before you move please contact your nearest Customer Care Centre, listed below, to give them details of your new home. They will then ensure that the local Service Organisation is aware of your move and able to look after you and your appliances.

France	Senlis	+33 (0) 44 62 29 29
Germany	Nürnberg	+49 (0) 800 234 7378
Italy	Pordenone	+39 (0) 800 117511
Sweden	Stockholm	+46 (0) 8 672 5360
UK	Slough	+44 (0) 1753 219899

Index

A

- Aqua Control15, 26
- Automatic adjustment foot9, 48

C

- Child safety feature32, 43
- Circulation pump9, 31
- Coloureds17, 27, 28
- Conditioner9, 18, 19, 23
- Conditioning11, 28
- Correcting the programme10
- Cottons17, 27, 28
- Cottons/Linen, Easy-Cares10, 27
- Customer Service15, 30, 32, 59

D

- Delay timer10, 12, 21
- Delicates11, 17, 27
- Detergent9, 18, 19, 24
- Detergent dispenser drawer9, 23

E

- Easy Iron12, 27
- Easy-Cares17, 27
- Emergency emptying37
- Emergency unlocking38
- Energy Saving programme12, 27

F

- Fashion11, 27

H

- Handwash11, 27
- Handwashable
 - silk11, 27
 - wool27

I

- In-wash stain treatment products23

L

- Linen17
- Load14, 27

M

- Multi-display10, 32, 59

N

- Net curtains16

O

- Opening the door22, 26, 38, 42

- Over-dosed26

P

- Pre-wash12, 23, 27
- Pre-wash detergent9, 23
- Programme option buttons12, 27
- Programme progress display10
- Programme protection22, 42
- Pump out11, 26

R

- Rating plate9, 49, 50, 59
- Refresh11, 27
- Rinse hold11, 20, 26
- Rinse+39
- Rinsing28
- Risk of frost6, 37

S

- Sensitive12
- Service & Spare Parts59
- Short Spin11
- Silk11, 17, 27
- Soaking12, 21
- Soaking agent23
- Softener8, 9, 23
- Spin22, 25
- Spinning11, 19, 20, 28
- Stain12, 27
- Stain removers9
- Starching11, 28

T

- Time Saver13, 27

U

- update15

W

- Warranty6, 32, 56
- Wash time14
- Water
 - hardness8, 18
 - pumping out26
 - softener8, 9, 18, 23
- Water cooling40
- Wool11, 17, 27

Service & Spare Parts

If after carrying out the necessary checks there is still a fault with your appliance please contact your local AEG Service Force Centre.

In guarantee customers should ensure that the suggested checks have been made as the engineer will make a charge if the fault is not a mechanical or electrical breakdown.

Please note that proof of purchase is required for in-guarantee service calls.

Service & Spare Parts

If you require a service engineer or wish to purchase spare parts, contact your local AEG Service Force Centre, by telephoning:

0870 5 929 929

Help us to help you

Please determine your type of enquiry before telephoning. When you contact us we need to know:

1. Your name, address, post code and your telephone number.
2. Clear and concise details of the fault.
 - What is the fault?
 - When does the fault occur?
 - Does the multi-display issue an error-message?
3. The model, production number and product identification number.
4. Date of purchase.

This information can be found on the rating plate, so you have these numbers to hand we recommend you write them below.

PNC

S-No.

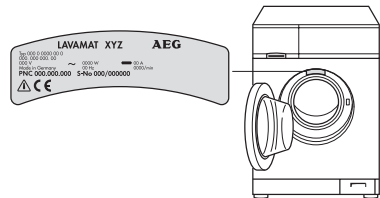

Customer Care

For general enquiries regarding your AEG appliance, or further information on AEG products please contact our customer care department by letter or telephone at the address below or visit our website at

www.aeg.co.uk

Customer Care Department
 AEG Domestic Appliances
 55-77 High Street, Slough, Berkshire SL1 1DZ
 Tel: 08705 350350*

*Calls to this number may be recorded for training purposes.

The Electrolux Group is the world's largest producer of powered appliances for kitchen, cleaning and outdoor use. More than 55 million Electrolux Group products (such as refrigerators, cookers, vacuum cleaners, chain saws and lawn mowers) are sold each year to a value of approx. 14 billion USD in more than 150 countries around the world.



From the Electrolux Group. The world's No.1 choice.

AEG Hausgeräte GmbH
Postfach 1036
D-90327 Nürnberg

<http://www.aeg.hausgeraete.de>

© Copyright by AEG

822 943 280-01-240502-01

Subject to change without notice