

LAVAMAT 50435

Washing Machine

User information



Dear Customer,

Please read this instruction book carefully before using the appliance. Please ensure you fully understand the safety instructions on the first pages of this instruction book.

Retain the instruction book for future reference, and pass it on to any future owners.



The warning triangle and / or key words (**Warning!**, **Caution!**, **Important!**) give information that is important for your safety or the function of the appliance is highlighted. It is imperative that this information is observed.



1. This symbol guides you step by step through the operation of the appliance.

2. ...



This symbol gives you additional information and practical tips on using the appliance.



Tips and information about the economical and environmentally friendly use of the machine are marked with the clover leaf.

In the event of a malfunction, these operating instructions contain information on how to remedy these faults yourself. See the section "What to do if ..."

Printed on recycled paper.

Thinking ecologically means acting ecologically ...

CONTENTS

Operating Instructions	6
Safety	6
Disposal	8
Environmental tips	8
Description of the Appliance	9
Front view	9
Detergent Dispenser Drawer	9
Control panel	10
Program Selector	10
Temperature Selector	12
Program Option Buttons	12
ON/OFF Button	13
Consumption Data and Wash Times	14
Before the First Wash	14
Preparing a Wash Load	15
Sorting and preparing a wash load	15
Washing Types and Care Symbols	16
Detergent and Conditioners	17
Which detergent and conditioner?	17
How much detergent and conditioner?	17
Water Softening	17
Running a Wash Cycle	18
Brief instructions	18
Loading the washing	18
Add detergent conditioner	19
Setting the Washing Program	20
Changing the Spin Speed/Selecting Rinse Hold	21
Starting the Washing Program	21
Wash Program Progress	22
Changing/Interrupting the Washing Program	22
Washing Cycle is complete/Removing Washing	23

Program Tables	24
Washing	24
Separate Rinse	25
Separate Conditioning/Starching	25
Separate Spin	25
Maintenance and Cleaning	26
Control panel	26
Detergent Dispenser Drawer	26
Washing Machine Drum	27
Main door	27
Cleaning the drain pump	28
What to do if	29
Trouble Shooting	29
If the washing results are not satisfactory	32
Carrying out an emergency emptying	33
Child Safety Feature	34
Installation and connection instructions	35
Installation Safety Precautions	35
Installation of the appliance	36
Transporting the appliance	36
Remove transport packaging	36
Installation-Site preparation	38
Installation on a Suspended Floor	38
Levelling the Appliance	39

Electrical Connection	40
Water connection	42
Water pressure	42
Inlet Hose Connection	43
Water Drainage	44
Pump head of greater than 1m	45
Technical data	46
Dimensions	46
Warranty conditions	47
Index	50
Service & Spare Parts	51

OPERATING INSTRUCTIONS



Safety

The safety features of AEG electrical appliances comply with accepted technical standards and the German Appliance Safety Law. However, we also consider it our obligation as a manufacturer to inform you about the following safety information.

Prior to initial start-up

- Observe the "**Installation and Connection Instructions**" in this instruction book.
- If the appliance is delivered in the winter months and temperatures are below freezing: Store the washing machine at room temperature for a few hours before putting it into operation.

Intended Use

- The washing machine is only intended for washing normal domestic washing. If the appliance is used for any other purpose or incorrectly operated, the manufacturer accepts no liability for any damages which may result.
- It is dangerous to alter the specifications or attempt to modify this product in any way.
- Only use detergents which are suitable for automatic washing machines, and follow the recommendations of the detergent manufacturer.
- Garments which have been in contact with flammable solvents should not be washed. Also bear this in mind when washing pre-cleaned washing.
- Do not use the washing machine for dry-cleaning.
- Dyes and bleaching agents may only be used if specifically permitted by the manufacturer of these products. We cannot be held liable for any damages.
- This appliance must be connected to the cold water supply only.
- Damage due to frost is not covered by the guarantee. If the washing machine is located in a room in which below freezing temperatures may occur, emergency emptying must be carried out (see "carrying out an emergency emptying").

Child Safety

- Packaging materials (e.g. films, styrofoam) can be dangerous for children. There is a risk of suffocation! Keep all packaging well away from children.
- This appliance is designed to be operated by adults. Do not allow children to tamper with the controls or play with the appliance.
- Pets and children have been known to climb into washing machines. Please check the drum before use.
- When disposing of the appliance, cut off the mains cable, and destroy the plug. Disable the door lock to prevent young children being trapped inside.

General Safety

- Repairs to washing machines must only be carried out by qualified personnel. Repairs carried out by inexperienced persons may cause injury or serious malfunctioning. Contact your local AEG Service Force Centre.
- Never operate the washing machine if the mains cable is damaged or the control panel, work top or base area are damaged allowing internal components to be accessible.
- Switch off the appliance and isolate from the mains supply before carrying out any cleaning or maintenance work.
- Do not use the mains cable to remove the plug from the socket. Always pull the plug itself.
- Adapters and extension cables must not be used. **There is a danger of overheating!**
- Do not clean the washing machine with a water jet. There is a danger of electric shock!
- During high temperature wash programmes the glass of the door may become hot. Do not touch!
- Allow the water to cool down before cleaning the drain pump, carrying out emergency emptying or opening the door in an emergency.
- Small animals/pets can chew on power cables and water hoses. This can lead to the risk of electric shock and water damage to the appliance and property. Keep small animals away from the appliance.



Disposal

Packaging

Dispose of the packaging material correctly. All packaging materials used are environmentally friendly and can be disposed of without any danger to the environment.

- Plastic parts can be recycled and are identified as follows:
 - >PE< for polyethylene, e.g. the outer covering and the bags in the interior.
 - >PS< for polystyrene, e.g. padding (always CFC-free)
 - >POM< for polyoxymethylene, e.g. plastic clips
- Cardboard packaging is manufactured from recycled paper and should be deposited in the waste paper collection for recycling.

When disposing of the washing machine!

Cut off the mains cable and destroy the plug. Disable the door catch to prevent young children becoming trapped inside. Use an authorised disposal site.



Environmental tips

To save water and energy, and to help protect the environment, we recommend that you follow these tips.

- Do not use a pre-wash for normally soiled washing.
- It is more economical to wash full loads.
- When washing small loads, reduce the detergent by half to two thirds.
- Pre-treat stains, and then wash at a lower temperature.
- Use the energy-saving program when washing light to normally soiled garments.
- In hard water areas, the use of a water softening agent can reduce the amount of detergent necessary. See manufacturers recommendations.

Description of the Appliance

Front view

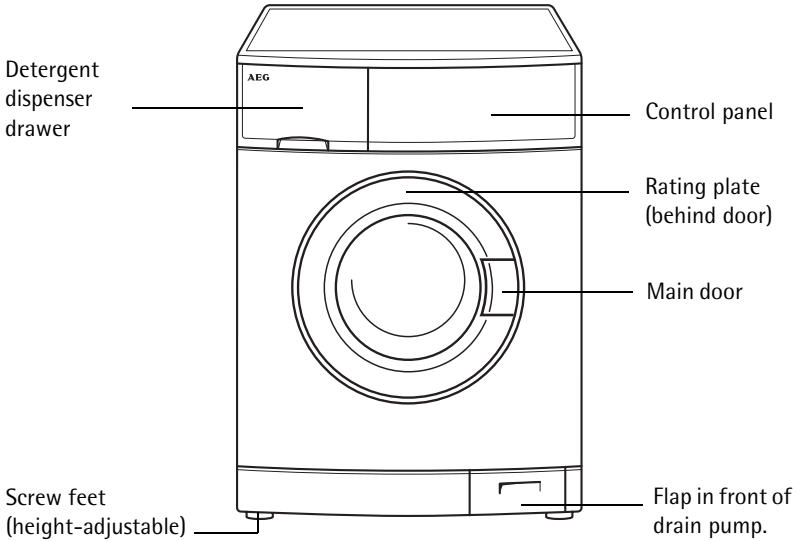

Detergent Dispenser Drawer

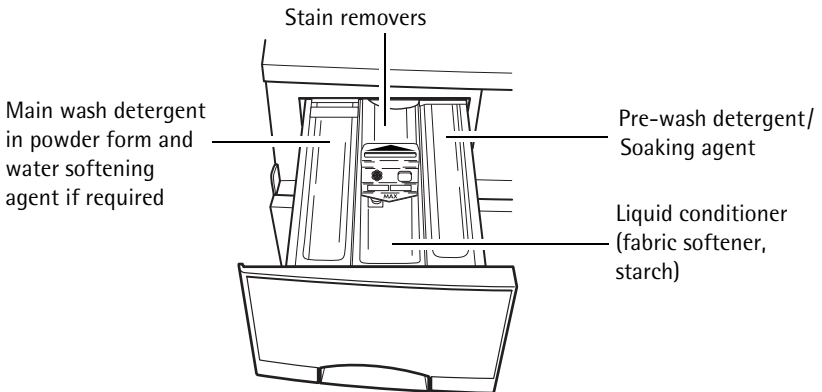

Control panel

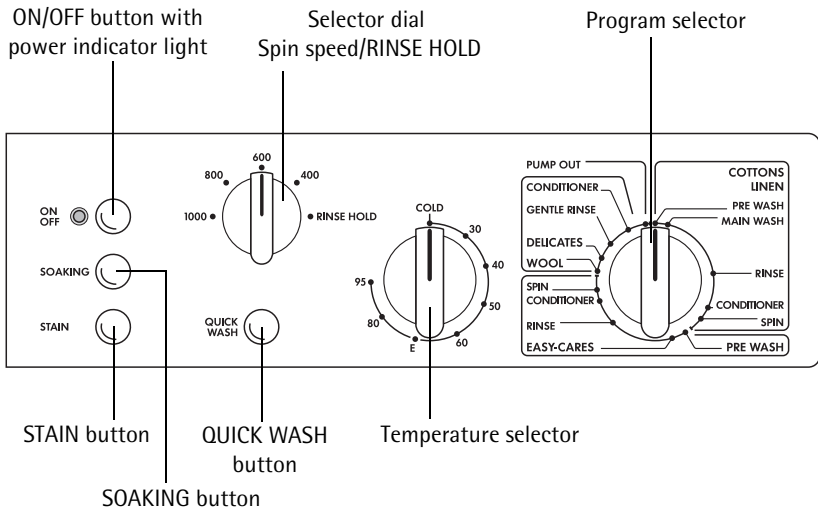

Program Selector

The program selector determines the type of wash cycle (eg. water level, drum movement, number of rinses, spin speed) according to the type of articles to be washed.

Important! Only turn the program selector in a clockwise direction!

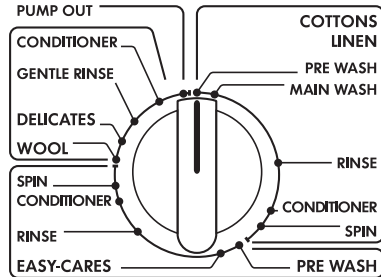

Programs COTTONS/LINEN

PRE WASH

Pre wash for cottons/linen (approx. 30 minutes, temperature limited to a maximum of 40 °C). The main wash follows immediately afterwards.

MAIN WASH

Main wash cycle for cottons/linen (cold up to 95 °C).

RINSE

Separate rinse followed by spin or rinse hold, eg. for rinsing hand-washed cottons/linen.



Rinse hold means: The washing remains in the last rinsing water and is not spun.

CONDITIONER

Separate conditioning, separate starching or separate finishing for damp cottons/linen (1 rinse, liquid conditioner is flushed in from the compartment  followed by spin or rinse hold).

SPIN

Spin after rinse hold or separate spin for handwashed cottons/linen.

EASY-CARES programs**PRE WASH**

Pre wash for easy-care fabrics (approx. 30 minutes, temperature limited to a maximum of 40 °C). The main wash cycle follows automatically.

EASY-CARES

Main wash cycle for easy-care fabrics (cold to 60 °C).

RINSE

Separate rinse followed by spin or rinse hold, eg. for rinsing hand-washed easy-care articles.

CONDITIONER

Separate conditioning, separate starching or separate finishing for damp easy-care fabrics (1 rinse, liquid conditioner is flushed in from the compartment  followed by spin or rinse hold).

SPIN

Spin after rinse hold or separate spin for handwashed easy-care articles, woollens and delicates.

Programs WOOL/DELICATES**WOOL**

Main wash cycle for machine washable woollens and particularly delicate fabrics (cold to 40 °C).

DELICATES

Main wash cycle for delicates (cold to 40 °C).

GENTLE RINSE

Separate gentle rinse followed by short spin or rinse hold, eg. for rinsing hand-washed woollens or delicates.

CONDITIONER

Separate gentle conditioning for damp woollens or delicates (1 gentle rinse, liquid conditioner is washed in from the compartment  followed by short spin or rinse hold).

Pump out

Water pumped out without spin, eg. after rinse hold.

Temperature Selector

The following settings are possible:
COLD, 30, 40, 50, 60, E, 80, 95 °C.



Position E (Energy-saving program):

For lightly or normally soiled cottons, the energy-saving program (approx. 70 °C) can be used instead of a wash cycle at 95 °C.

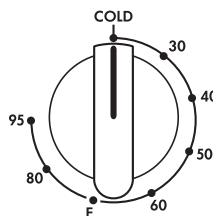

Program Option Buttons

The program option buttons are used to adapt the wash program to suit the degree of soiling of the washing. Program options are not required for normally soiled washing.



The additional can only be used in conjunction with the COTTONS/LINEN and EASY-CARES programs.

SOAKING

Soaking time approx. 35 minutes;
Temperature limited to a maximum of 40 °C.

SOAKING can be used in conjunction with program selector settings:

- PRE WASH (COTTONS/LINEN);
- PRE WASH (EASY-CARES).



At the end of the soaking program the washing will remain in the water until you release the SOAKING button by pressing it again. The main wash cycle for COTTONS/LINEN or EASY-CARES will follow.

STAIN

For dealing with heavily soiled or stained washing (in-wash stain treatment is added at the optimum time during the course of the program).

STAIN can be used in conjunction with the program selector settings:

- PRE WASH (COTTONS/LINEN);
- PRE WASH (EASY-CARES);
- MAIN WASH;
- EASY-CARES.

STAIN



QUICK WASH

Shorter washing cycle for lightly soiled washing.

QUICK WASH can be used in conjunction with the program selector settings:

- MAIN WASH;
- EASY-CARES.

QUICK
WASH

ON/OFF Button

Pressing the ON/OFF button switches the washing machine on and starts the selected program. Pressing the button again switches the washing machine off.

ON
OFF

Consumption Data and Wash Times

The values given in the following table for selected programs were calculated under standardized conditions. They provide a useful guide for operation in the home.

Program Selector	Temperature Selector	Load in kg	Water in Litres	Energy in kWh	Time in Minutes
COTTONS/LINEN MAIN WASH	95	5	57	1.90	140
COTTONS/LINEN MAIN WASH	60 ¹	5	54	0.95	128
COTTONS/LINEN MAIN WASH	40	5	54	0.60	115
EASY-CARES	40	2.5	45	0.40	65
DELICATES	30	2.5	40	0.25	40
WOOL	30	2	43	0.25	50

1) **Note:** The selected program is tested in accordance with EN 60 456. The consumption values, however, can deviate depending on the following: water pressure, water hardness, water inlet temperature, room temperature, washing type and quantity, the detergent used, fluctuations in the mains voltage and the selected program options.

Before the First Wash

1. Pull the washing powder drawer out slightly.
2. Pour about 1 litre of water through the detergent disperser drawer into the washing machine. The next time a program is started the solution container will be closed and the OKO valve can function correctly.
3. Run one wash cycle without washing:
 - MAIN WASH Program;
 - Temperature 95 °C;
 - use half the quantity of detergent recommended by the manufacturer for a full load.

This removes any residues from the drum and solution container which may have been left during manufacturing.

Preparing a Wash Load

Sorting and preparing a wash load

- Sort washing according to the care symbol and type (see "Washing types and care symbols").
- Empty all pockets.
- Remove metal objects (paper clips, safety pins etc.).
- In order to prevent bunching up of washing and damage to washing, close zippers, button up duvet covers and pillow cases, and tie up loose straps such as from aprons.
- Turn articles with double layered textiles inside out (sleeping bags, anoraks etc.).
- Coloured, knitted fabrics, as well as wool and fabrics with appliqués should be turned inside out.
- Place small and delicate items (e.g. socks, tights and stockings, bras etc.) in a washing net, or pillow case.
- Handle curtains with care. Metal rollers or burred, plastic rollers must be removed or tied into a net or bag. We cannot accept liability for damage.
- Do not wash coloured and white washing together. This could discolour white washing or turn it grey.
- New, coloured washing often contains excessive dye. Wash these separately the first time.
- Mix small and large items of washing. This improves washing efficiency and the washing is more evenly distributed during the spinning cycle.
- Shake out washing before placing into the washing machine.
- Do not place folded washing into the drum.
- Observe tips such as "wash separately" and "wash separately several times".

Washing Types and Care Symbols

The care symbols help you choose the correct washing program. Washing should be sorted according to type and care symbol. The temperatures indicated in the care symbols are all maximum temperatures.

Cottons

Fabrics made from cotton and linen with this care symbol will withstand maximum wash actions and high temperatures. The COTTONS/LINEN program is appropriate for this type of washing.

Linen

Fabrics made from cotton and linen which carry this care symbol will withstand maximum wash actions. The COTTONS/LINEN program is appropriate for this type of washing.

Easy-care washing



Fabrics such as treated cotton, cotton mixed fabrics, viscose and synthetics which carry this care symbol need a softer wash action. The EASY-CARES program is appropriate for this type of washing.

Delicates

Fabrics such as those with layered fibres, micro fibres, viscose, synthetics, as well as curtains with this care symbol require particularly careful handling. The DELICATES program is appropriate for this type of washing..

Woollens and particularly delicate washing

Fabrics such as wool, wool mixtures and silk which carry these care symbols require a very gentle wash cycle. The WOOL program is appropriate for this type of fabric.

Important! Fabrics with care symbols  (Handwash) or  (Do not wash!) must not be washed in washing machines.

Detergent and Conditioners

Which detergent and conditioner?

Use only detergents and conditioners which are suitable for use in automatic washing machines. Always follow the manufacturer's instructions.

How much detergent and conditioner?

The required quantity depends upon:

- the extent of soiling of the washing
- the hardness class of the mains water
- the amount of washing



Should the detergent manufacturer not specify the dosage quantity for less than full loads, reduce the detergent accordingly:
 for a half load reduce the quantity by 1/3.
 for a small load reduce the quantity by 1/2.
 Observe the instructions for use and dosing provided by the detergent and conditioner manufacturer.

Water Softening

For medium to high water hardness (hardness class II upwards) a water-softening agent can be used. Refer to the manufacturer's instructions. Then always add the appropriate amount of detergent (underdosing) for hardness class I (soft). Your local Water Authority can advise you on the hardness of the water in your area.

Water hardness scales

Hardness Category	Water Hardness in °dH (German degrees of hardness)	Water Hardness in ppm (Parts Per Million)
I – soft	0 - 7	to 125
II – medium hard	7 - 14	125 - 250
III – hard	14 - 21	250 - 375
IV – very hard	greater than 21	Greater than 375

Running a Wash Cycle

Brief instructions

A wash cycle consists of the following steps:



-  1. Open the door and load the washing.
2. Close the door.
3. Add detergent/conditioner.
4. Set the wash program:
 - Set the program using the program selector;
 - Set the temperature using the temperature selector;
 - Set any program options if required.
5. If necessary, change the spin speed or select RINSE HOLD.
You can alter this setting and the temperature at any time during the wash.
6. Press the ON/OFF button. Power indicator light comes on.
The washing machine has been switched on. The wash program will start.

When the wash program has ended:

Important! If the wash cycle ended with a rinse hold, carry out PUMP OUT or SPIN before opening the door.

-  For safety reasons, the door remains locked for 1-2 minutes after the end of the program.
7. Open the door and remove the washing.
8. Press the ON/OFF button. The power indicator light will go out.
The washing machine has been switched off.

Loading the washing

-  See "Program Tables" for maximum loads.
For information about the correct preparation of the washing see "Sort and prepare washing".
-  1. Sort and prepare the washing according to type.
2. Open the door: Pull the handle on the door.
3. Load the washing.
Important! Do not trap washing when closing the door. The fabrics and the machine could be damaged.
4. Close the door firmly.

Add detergent conditioner

i For instructions concerning detergents and conditioners see section "Detergents and conditioners".

- 1.** Pull the detergent dispenser drawer out as far as it will go.
- 2.** Add detergent/conditioner

Compartment for in-wash stain treatment

(only for additional program STAIN)

Compartment for main wash detergent (powder only) and water softener if required

(If you are using water softener, add it to the main wash detergent.)

Compartment for liquid care agent

(Conditioner, finisher, starch)

Important! Do not fill the compartment above the MAX mark.

Dilute viscous agent if necessary up to the MAX mark, and dissolve starch powder.

Compartment for pre-wash agent/soaking agent

(only for PRE WASH or SOAKING programmes)

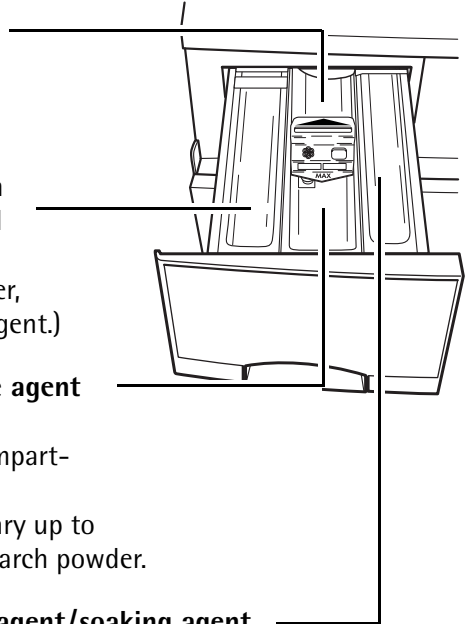

- 3.** Push the detergent dispenser drawer in fully.

i If using liquid detergent/tablets

Use containers supplied by the detergent manufacturers to add liquid detergent or tablets. Follow the instructions on the washing detergent package.

Setting the Washing Program

i See "Program Tables" for a suitable program, correct temperature and possible program options to suit the type of washing.

Important! Only turn the program selector in a clockwise direction.

1. Set the program selector to the desired wash program.

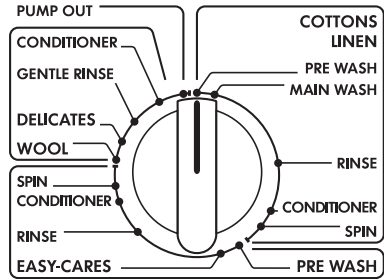

2. Set the temperature selector to the desired temperature.

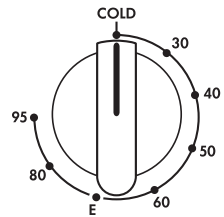

3. Select program options if required:

- SOAKING can be used in conjunction with the program settings:
 - PRE WASH (from COTTONS/LINEN program group);
 - PRE WASH (from EASY-CARES program group).
- STAIN can be used in conjunction with the program settings:
 - PRE WASH (from COTTONS/LINEN program group);
 - PRE WASH (from EASY-CARES program group).
 - MAIN WASH;
 - EASY-CARES.
- QUICK WASH can be used in conjunction with the program settings:
 - MAIN WASH;
 - EASY-CARES.

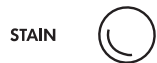

Changing the Spin Speed/Selecting Rinse Hold

 If required, change the spin speed for the final spin speed or select RINSE HOLD: Turn the selector dial to the required speed or to RINSE HOLD.

If RINSE HOLD is selected, the washing remains in the final rinse water. It is not spun.

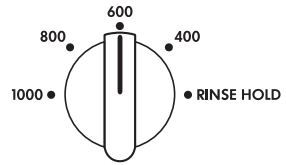

 If the set spin speed is too high for the selected wash program, the final spin speed will be adjusted automatically:

- COTTONS/LINEN 1000 revolutions per minute
- EASY-CARES 850 revolutions per minute
- DELICATES 650 revolutions per minute
- WOOL 850 revolutions per minute

The speed of the intermediate spin is dependent on the selected program and cannot be changed.

Starting the Washing Program

-  1. Check that the water tap is open.
2. Press ON/OFF button. The power indicator light will come on.
The washing machine has been switched on.
The wash program will start.



Wash Program Progress

Program progress display

The program selector is also a program progress display. It turns clockwise as the program progresses until it ends, showing the stage of the program that is currently being carried out. The speed at which the program selector turns varies.

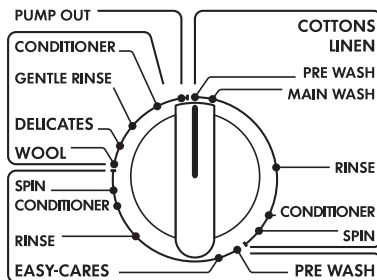

Changing/Interrupting the Washing Program

Changing settings

Whilst the wash program is in progress you can

- change the spin speed;
- select RINSE HOLD.

To select a different program you must first interrupt the program that is running and then re-set.

Interrupting the wash program

1. Press ON/OFF button. The power indicator light will go out.
 2. Turn the program selector clockwise either to PUMP OUT or to SPIN.
 3. Press ON/OFF button again. The power indicator light will come on.
- Water is:
- pumped out or
 - pumped out and the washing then spun.

Washing Cycle is complete/Removing Washing

A wash program normally ends with the final spin.

If SOAKING has been selected:

-  Release the SOAKING button (main wash for COTTONS/LINEN or EASY-CARES will run).

If RINSE HOLD has been selected:

The water must first be pumped out or the washing must still be spun.

-  Either turn the spin speed selector dial to the required speed (water will be pumped out and the washing spun according to the program that has been run; the spin speed can still be changed even during the spin),
or
turn the program selector clockwise to PUMP OUT (water is pumped out without spinning),
or
turn the program selector clockwise to SPIN (water is pumped out and the washing spun at the set speed; the spin speed can still be changed even during the spin).

Once the program is completed:

-  For safety reasons, the door remains locked for 1-2 minutes after the end of the program.









- 
 1. Open the door.
 2. Remove the washing.
 3. Press ON/OFF button. The power indicator light will go out. The washing machine has been switched off.
 4. Turn off the water tap.
 5. Pull the washing detergent dispenser drawer out slightly to allow it to dry. Leave the door ajar so that air can circulate in the drum.

Important! If the washing machine is not to be used for a long period: Close the water tap and disconnect the washing machine from the electricity mains.

Program Tables

Not all possible settings are listed below, only those which are useful and meaningful in everyday use.

Washing

Type of Washing Care Symbols	Max. Load (dry weight) ¹⁾	Program Selector	Temperature Selector	Possible Program Options
Cottons 	5 kg	PRE WASH	60 to 95	SOAKING STAIN
		MAIN WASH	60 to 95	STAIN QUICK WASH
Energy-saving program: Cottons 	5 kg	PRE WASH	E	SOAKING STAIN
		MAIN WASH		STAIN QUICK WASH
Linen  	5 kg	PRE WASH	30 to 60	SOAKING STAIN
		MAIN WASH	30 to 60	STAIN QUICK WASH
Easy-cares  	2.5 kg	PRE WASH	30 to 60	SOAKING STAIN
		EASY-CARES	30 to 60	STAIN QUICK WASH
Delicates 	2.5 kg (or 15-20 m ² Net curtains)	DELICATES	COLD to 40	
Woollens ²⁾  	2 kg	WOOL	COLD to 40	

1) A 10 litre bucket holds approximately 2.5 kg of dry washing (cotton).

2) Woollen articles with a woolmark may only be washed in the machine if the label also states "machine-washable".

This machine is capable of washing 5.5 kg, however, to achieve optimum wash results it is recommended that the wash loads quoted in this instruction book are adhered to.

Separate Rinse

Type of Washing	Max. Load (dry weight)	Program Selector
Cottons/Linen	5 kg	RINSE
Easy-cares	2.5 kg	RINSE
Delicates	2.5 kg	GENTLE RINSE
Woollens	2 kg	

Separate Conditioning/Starching

Type of Washing	Max. Load (dry weight)	Program Selector
Cottons/Linen	5 kg	CONDITIONER
Easy-cares	2.5 kg	CONDITIONER
Delicates	2.5 kg	CONDITIONER
Woollens	2 kg	

Separate Spin

Type of Washing	Max. Load (dry weight)	Program Selector
Cottons/Linen	5 kg	SPIN
Easy-cares	2.5 kg	SPIN
Delicates	2.5 kg	
Woollens	2 kg	

Maintenance and Cleaning

Control panel

Important! Do not use household furniture polish or abrasive cleaners to clean panel and operating parts.

- ☞ Wipe over the operating panels with a damp cloth. Use warm water.

Detergent Dispenser Drawer

The detergent dispenser drawer should be cleaned from time to time.

- ☞ 1. Pull the detergent dispenser drawer out as far as it will go.
- 2. Remove the detergent dispenser drawer by pulling sharply.
- 3. Take the conditioner insert out of the middle compartment.
- 4. Clean the conditioner insert under running water.

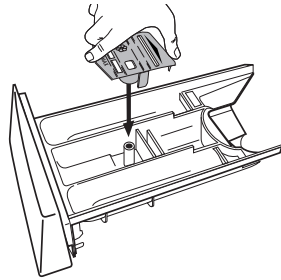

- 5. Clean the separate compartments with warm water. It is best to use a flat brush.

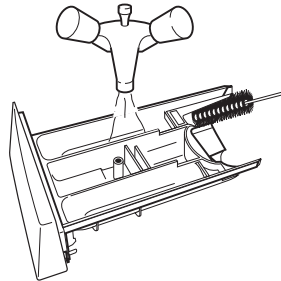

- 6. Push on the conditioner insert as far as it will go so that it is securely in place.

- Use a brush to clean the entire compartment area of the washing machine, particularly also the nozzles on the top side of the compartment.

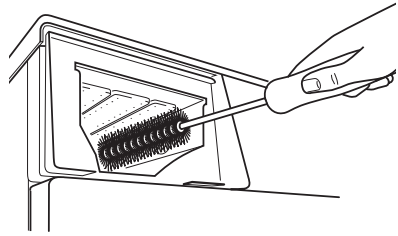

- Set the detergent dispensing drawer into the guide tracks and push it in.

Washing Machine Drum

The washing machine drum is made from rust-free stainless steel. Any objects left in the laundry which are likely to rust can stain the drum.

Important! Do not clean the stainless steel drum with descaling agents containing acids, scouring agents containing chlorine or iron, or steel wool. Your local AEG Service Force Centre has suitable agents available.

- Remove any rust stains on the drum using a stainless steel cleaning agent.

Maintenance Wash

- With the use of low temperature washes it is possible to get a build up of residues inside the drum. We recommend that a maintenance wash be performed on a regular basis.

To run a maintenance wash:

The drum should be empty of laundry.

- Select the hottest cotton wash program.
- Use a normal measure of detergent, must be a powder.

Main door

- Regularly check to see if there are deposits or foreign objects in the rubber seal behind the door, and remove them.

Cleaning the drain pump

Paper clips, nails and so on can sometimes get into the washing machine with the washing and remain in the drain pump casing. Fluff and strands of fabric can gather on these items and block the drain pump.

Therefore the drain pump should be cleaned at least once a year.



Warning! Switch off the washing machine and pull out the mains plug before cleaning the drain pump.

1. First carry out emergency emptying (see section "Carrying out emergency emptying").
2. Place a towel on the floor in front of the cover of the drain pump. Surplus water may flow out.
3. Unscrew the drain pump cover anti-clockwise and pull it out.

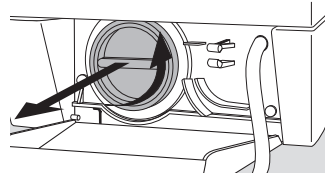

4. Remove any foreign bodies from the pump housing.

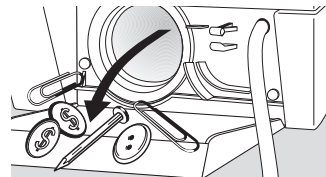

5. Replace the cover. Insert the webs on the cover laterally into the guide slots and screw on the cover securely clockwise.

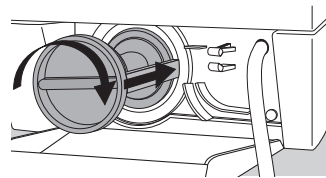

6. Close the emergency emptying hose and place it in the holder.
7. Close the flap.

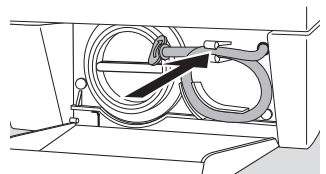

What to do if ...

Trouble Shooting

Try to rectify minor faults on the washing machine with the aid of the instructions given here. If you call out an engineer to resolve a fault listed here, or to repair a fault caused by incorrect use or installation, a charge will be made even if the appliance is under guarantee.

Problem	Possible Cause	Remedy
The washing machine does not work.	The mains plug is not plugged in.	Insert the mains plug.
	The house fuse has blown.	Replace the fuse.
	The door is not closed correctly.	Close the door; The lock must engage audibly.
Door cannot be closed.	The child safety feature is set.	Cancel the child safety feature (see the section "Child Safety Feature").
The machine does not take in water.	The door is not correctly closed.	Close the door; The lock must engage audibly.
	Water tap is closed.	Open the water tap.
	Filter in screw connection of the inlet hose is blocked.	Close the water tap. Unscrew the hose from the tap, remove the filter and clean it under running water.
Excessive foaming during the main wash.	Probably too much detergent was used	It may be necessary to reduce the amount of detergent used. Follow the detergent manufacturer's recommendations.

Problem	Possible Cause	Remedy
<p>The washing machine vibrates during operation or is unstable.</p>	<p>The transport packaging has not been removed.</p>	<p>Remove transport packaging according to the installation and connection instructions.</p>
	<p>The machine is not level.</p>	<p>Adjust the feet according to the installation and connection instructions.</p>
	<p>There is very little washing in the drum (e.g. only one dressing gown).</p>	<p>This does not impair the function.</p>
	<p>The water could not be completely pumped out before spinning because the drain hose is kinked or the drain pump is blocked.</p>	<p>Check the drain hose and remove any kink if necessary, or clean the drain pump and, if required, remove foreign bodies from the pump housing.</p>
<p>Water runs out from under the washing machine.</p>	<p>The screw connection on the inlet hose is leaking.</p>	<p>Tighten the inlet hose screw connection</p>
	<p>The drainage hose is leaking.</p>	<p>Check the drainage hose and replace it if necessary.</p>
	<p>The drain pump cover is not correctly closed.</p>	<p>Close cover correctly.</p>
	<p>Washing is caught in the door.</p>	<p>Stop the program and remove the washing caught in the door. Restart the program.</p>
	<p>The emergency emptying hose is not correctly sealed or is leaking.</p>	<p>Seal the emergency emptying hose correctly (see section "Carrying Out an Emergency Emptying"). Call your local AEG Service Force Centre if the emergency emptying hose leaks.</p>
<p>The washing machine does not spin; there is water in the drum.</p>	<p>RINSE HOLD has been selected.</p>	<p>Cancel RINSE HOLD.</p>
	<p>Soaking program has finished.</p>	<p>Release SOAKING button (main wash program will follow).</p>

Problem	Possible Cause	Remedy
Fabric softener was not washed into machine; drawer  for conditioner is filled with water.	The conditioner insert has not been correctly positioned inside the conditioner compartment or is blocked.	Clean the detergent dispenser drawer and attach the conditioner insert securely.
Washing is heavily creased	Probably too much washing was put into the drum.	Pay attention to the maximum load quantity (see Program tables). In the case of easy-care fabrics, select the EASY IRON program.
Washing has not been spun properly. Water is left in the drum.	Drain hose is kinked.	Remove the kink.
	Maximum pump head (discharge height 1 m from the appliance's base) is exceeded.	Contact your local Service Force Centre. For pumping heights over 1 m a conversion kit is available as a special accessory.
	Drain pump is blocked.	Switch off the appliance and pull out the mains plug. Clean the drain pump.
Remnants of detergent are building up in the detergent dispenser drawer.	Water tap is not fully open.	Open the water tap fully.
	The inlet hose filter in the coupling inlet hose at the tap is blocked.	Close the water tap. Unscrew the inlet hose from the water tap and from the appliance. Clean the filter.
The rinsing water is cloudy.	The cause is probably a detergent with a high silicate content.	No negative effect on the rinse results; use a liquid detergent if necessary.
Door cannot be opened.	Door is locked for safety reasons.	Wait for 1 or 2 minutes after the end of the program.

If the washing results are not satisfactory

If the washing turns greyish and limescale deposits are present in the drum

- Insufficient detergent has been added.
- Incorrect detergent was used.
- Stains were not pre-treated.
- Program or temperature was not set correctly.
- If using modular detergents, the individual components were not used in the correct ratio.

If there are still grey stains on the washing

- Soiled garments with ointments, grease or oils were washed with insufficient detergent.
- The temperature selected for the wash was too low.
- A frequent cause is that fabric softener - particularly a concentrated one - has come into contact with the washing. Wash out these types of stains as soon as possible and use the fabric softener carefully.

If after the last rinse foam is still visible

- Modern detergents can still cause foam in the final rinse cycle. However, the washing is still sufficiently rinsed.

If there are white residues on the washing

- These are insoluble contents of modern detergents. They are not the result of an insufficient rinse. Shake out the washing or brush it off. Turn the washing inside out before washing it. Review your choice of detergent and if necessary use liquid detergent.

Carrying out an emergency emptying

- If the washing machine no longer pumps out the water, emergency emptying must be carried out.
- If the washing machine is located in a room in which below freezing temperatures might occur, emergency emptying must be carried out. Furthermore: unscrew the inlet hose from the water tap and drain off the water. Empty the drainage hose.



Warning! Switch off the washing machine and pull out the mains plug prior to performing emergency emptying.

Warning! The water, which flows out of the emergency emptying hose can be hot. First allow the water to cool down before you carry out the emergency emptying.

1. Have a flat container on hand to catch the water.
2. Pull down the flap in the right corner of the base strip outwards and pull it off.

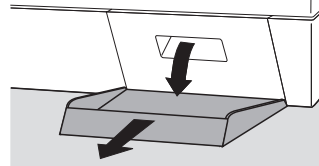

3. Remove the emergency emptying hose from its holder.

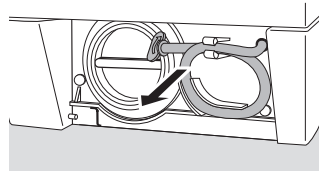

4. Place the container under the hose.
5. Detach the plug of the emergency emptying hose by turning it anticlockwise and pull it out.

The water runs out. Depending on the amount of water, it may be necessary to empty the collecting vessel several times. To do this, close the emergency emptying hose temporarily with the plug.

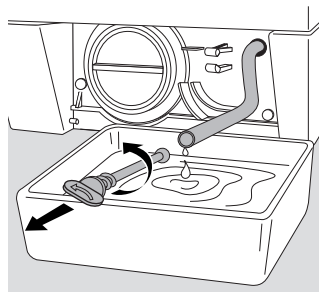

Discard the water from the container, replace it under the emergency emptying hose and remove the plug from the hose.

When the water is completely drained:

6. Push the plug securely into the emergency emptying hose and turn it clockwise to secure it.
7. Replace the emergency emptying hose in its holder.
8. Put on the flap and close.

Child Safety Feature

If the child safety feature is set, the door cannot be closed and no washing program can be started.

Setting the child safety feature



Use a coin to turn the rotary knob on the inside of the door clockwise as far as it will go.

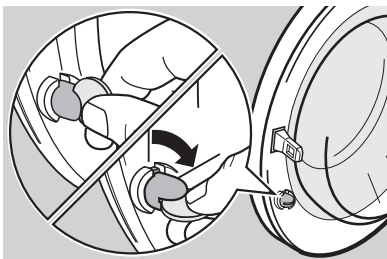

Warning! The rotary knob must not be in a vertical position after adjustment, otherwise the child safety feature is not active. The rotary knob must project as shown in the diagram.

Cancelling the child safety feature



Turn the rotary knob anticlockwise as far as it will go.

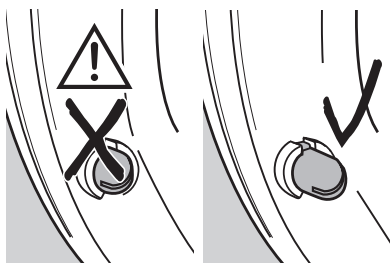

INSTALLATION AND CONNECTION INSTRUCTIONS

Installation Safety Precautions

- When moving do not tilt the washing machine onto its front or onto its right hand side (viewed from the front). This is to prevent the possibility of the electronic components becoming wet.
- Before installation inspect the machine for transport damage. Do not connect the appliance if it is damaged - contact your retailer.
- Ensure all packaging and transit bolts/bars have been removed, see „Removal of Transit Packaging“. Failure to remove transit bolts/bars may cause serious damage to the appliance or property.
- Always insert the plug into a correctly installed earthed socket.
- Any plumbing work required to install this appliance should be carried out by a plumber or competent person.
- Check that the electricity supply is the same as that indicated on the appliance's rating plate.
- Any electrical work required to install this appliance should be carried out by an electrician or competent person.

Installation of the appliance

Transporting the appliance

- Do not place the washing machine on its front or on its right hand side (viewed from the front). This is to prevent the possibility of the electronic components becoming wet.
- Never transport the unit without the transport packaging and bolts/bars. Do not remove the transport packaging until the appliance is at the installation location. Transporting the unit without the transport packaging can damage it.
- Never lift the appliance by the door.
- When transporting the unit with a sack trolley: Attach the sack trolley at the side only.

Remove transport packaging

Important! It is essential to remove the transport packaging before putting the appliance into operation. Keep all parts of the transport packaging in a safe place for future use.

1. Open both hose holders on the appliance's rear side and remove the hoses and mains cable.

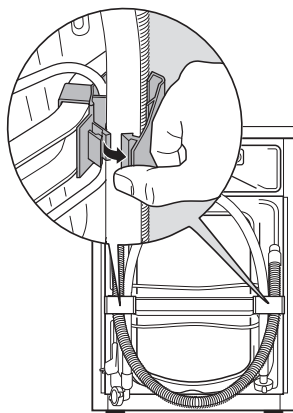

2. Pull both hose holders off the appliance with a strong pull.

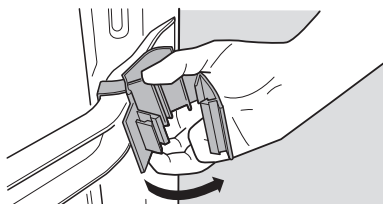

i The special spanner (E) and the caps (D) (2 each) and (G) (1 each) are supplied with it.

3. Remove the two screws (A) with the special spanner.
4. Remove the 4 screws (B).
5. Remove the transit bar (C).
6. Screw the 4 screws (B) back in for safe keeping.
7. Close the 2 large holes with the caps (D).

Important! When fitting the plastic caps, press until they snap into the rear panel securely.

8. Remove the screw F, including the sleeve, compression spring and washer, with the special spanner E.
9. Cover the hole with the cap G.

Important! When fitting the plastic caps, press until they snap into the rear panel securely.

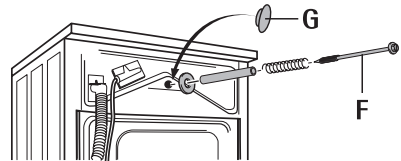
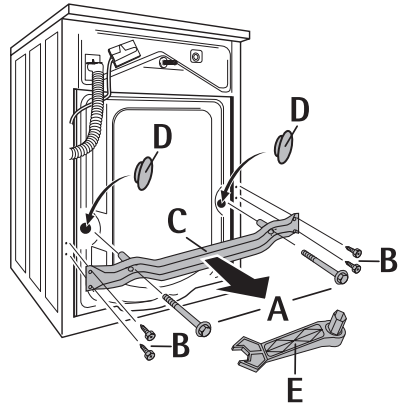

Installation-Site preparation

- The installation surface must be clean, dry and level. Do not install on a deep pile carpet.
- Minor unevenness of the floor surface should never be levelled out by laying pieces of wood, card or similar materials, but should always be compensated for by adjusting the screw feet.
- If the appliance is installed next to a heat source (e.g. cooking appliance), a heat insulating pad (87 x 57 cm) must be placed between the appliance and the heat source.
- Do not install the appliance in locations where the temperature may fall below freezing.
- Please ensure that when the appliance is installed it is easily accessible for the engineer in the event of a breakdown.

Installation on a Suspended Floor

Suspended wooden floors are particularly susceptible to vibration. To help prevent vibration we recommend you place a waterproof wood panel, at least 15 mm thick under the appliance, secured to at least 2 floor beams with screws. If possible install the appliance in one of the corners of the room, where the floor is more stable.

Levelling the Appliance

Floor unevenness can be compensated for and the height can be corrected with the four adjustable screw feet. The height can be adjusted in a range of +10 ... -5 mm.

To adjust the feet use the special spanner supplied.

-  1. Slide the special key firmly onto the hexagon head of the threaded foot as far as it will go.
2. Adjust the screw feet so that the appliance is horizontal and stable.
3. Check that the appliance is level using a spirit level.

Important. Never use strips or shims of wood or cardboard etc. To compensate for any unevenness in the floor. Always use the adjustable feet.

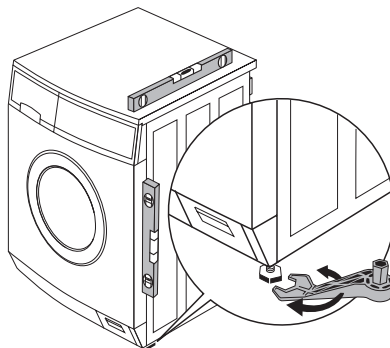

Electrical Connection

Any electrical work required to install this appliance should be carried out by a qualified electrician or competent person.



WARNING - THIS APPLIANCE MUST BE EARTHED.

The manufacturer declines any liability should these safety measures not be observed.

Before switching on, make sure the electricity supply voltage is the same as that indicated on the appliance rating plate.

The rating plate is located at the top of the rim of the open door.

The appliance is supplied with a 13amp plug fitted. In the event of having to change the fuse in the plug supplied, a 13amp ASTA approved (BS 1362) fuse must be used.

Should the plug need to be replaced for any reason, proceed as described below.

The wires in the mains lead are coloured in accordance with the following code:

Green and Yellow:	Earth
Blue:	Neutral
Brown:	Live

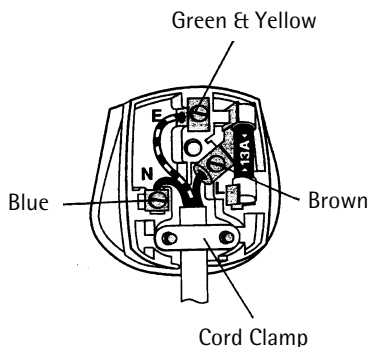
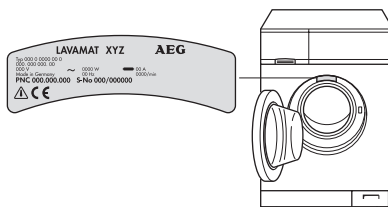

- The wire coloured green and yellow must be connected to the terminal marked with the letter "E" or by the earth symbol \oplus or coloured green and yellow.
- The wire coloured blue must be connected to the terminal "N" or coloured black.
- The wire coloured brown must be connected to the terminal marked "L" or coloured red.
- Upon completion there must be no cut, or stray strands of wire present and the cord clamp must be secure over the outer sheath.



WARNING! A cut off plug inserted into a 13 amp socket is a serious safety (shock) hazard. Ensure that the cut off plug is disposed of safely.

Permanent Connection

In the case of a permanent connection it is necessary that you install a double pole switch between the appliance and the electricity supply (mains), with a minimum gap of 3 mm between the switch contacts and of a type suitable for the required load in compliance with the current electrical regulations.

The switch must not break the yellow and green earth cable at any point.



This appliance is in accordance with the following EU Guidelines:

- Low Voltage Guidelines 73/23 EEC dated 19 February 1973, include Guideline Change Notice 93/68 EEC
- EMC Guideline 89/336 EEC dated 3 May 1989, including Guideline Change Notice 92/31 EEC.

This appliance complies with the requirements laid out in the EEC Directive 76/899.

Voltage 240 V AC: Fuse rating 13 amps

See rating plate for further information.

This appliance meets VDE requirements.

Particular regulations of local electricity authorities must be observed.

This appliance conforms to EEC Directive No. 82/499/EEG on radio interference.



WARNING! Repairs to electrical appliances must only be carried out by trained personnel. Improper repairs may lead to serious risks for the user.

Water connection



The washing machine is provided with safety devices preventing back-contamination of the water supply and complies with local water authority requirements.

This appliance is designed to be permanently plumbed into your home's water supply.

Before connecting up the machine to new pipework or to pipework that has not been used for some time, run off a reasonable amount of water to flush out any debris that may have collected in the pipes.

Important!

- Appliances for connecting to cold water must not be connected to hot water.
- Only use new hose sets for the connection.

Water pressure

The appliance is designed to operate within the following water pressure units. Minimum 1 bar ($= 10\text{N/cm}^2 = 0.1\text{ Mpa}$), maximum 10 bar ($= 100\text{N/cm}^2 = 1\text{ Mpa}$).

- If more than 10 bar: Install a pressure-reduction valve upstream
- If less than 1 bar: Unscrew the inlet hose from the appliance at the inlet solenoid valve and remove the flow regulator (to do this, remove the filter with needle nose pliers and remove the rubber washer behind the filter). Replace the filter.

Inlet Hose Connection

A pressure hose of 1.35m in length is supplied.

If a longer inflow hose is required, only a VDE-approved, complete set of hoses with fitted hose screw connections is permissible, available from AEG Service Force Centres.

- Hose sets in lengths of 2.2m, 3.5m, and 5m are available for washing machines without Aqua-Control.
- Hose sets in lengths of 2.0m, 2.9m and 3.9m are available for washing machines with Aqua-Control.

Important! Never cut into pieces in order to extend the hoses!

i Sealing rings are supplied either in the plastic nuts of the hose screw connection or in the enclosed pack. Do not use other seals!

1. Connect the hose with the angled connection to the machine.

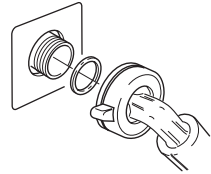

Important!

- Do not lay the inlet hose vertically downwards, instead run it to the right or left as shown in the diagram.
- Only tighten the hose screw connection by hand.

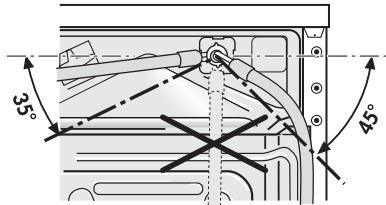

2. Connect the hose with the straight connection to a water tap with a screw thread R 3/4 (inches)

Important! Only tighten the screw connection by hand.

3. By slowly opening the water tap before putting the washing machine into operation, check that the connection is free of leaks.

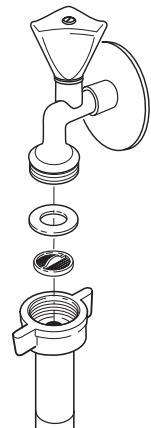

Water Drainage

The appliance drain hose should hook into a standpipe, the hook in the drain hose is formed using the plastic "U-Piece" supplied. The standpipe should have an internal diameter of approximately 38 mm (see diagram) thus ensuring there is an air break between the drain hose and standpipe.

Important! It is essential to lay the drainage hose without kinks.

When discharging into a standpipe ensure that the top of the curve in the hose end is no more than 90 cm (35.4") and no less than 60 cm (23.6") above floor level.

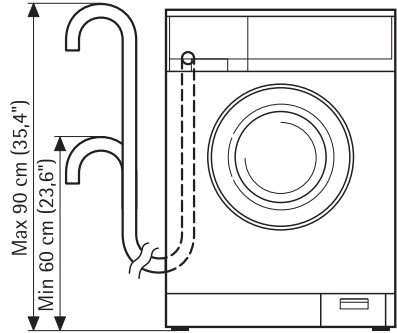

The upright standpipe should have a minimum, length of 30 cm (12") from the bottom of the elbow to the top of the pipe (see diagram). Make sure that it is designed in such a way that the end of the drain hose cannot be covered with water.

Longer drain hoses are available in lengths of 2.7 and 4 metres from your AEG Service Force Centre.

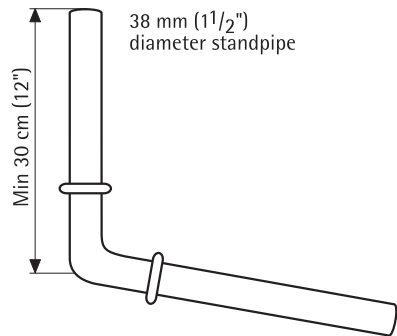

If you intend the drain hose from the washing machine to empty into a sink, make sure that the sink is empty and the plug hose is not blocked. Use the plastic "U-Piece" supplied.

Important! The end of the drainage hose must not be submerged in the pumped-out water. Otherwise, the water could be sucked back into the appliance.

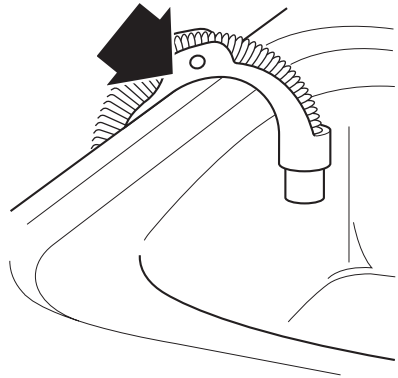

Pump head of greater than 1m

Every washing machine includes a wash water pump for the removal of wash and rinse water, which can pump fluids through the outlet hose up to a height of 1m, measured from the surface on which the machine stands.

For pump heads of greater than 1m please contact your local AEG Service Force Centre.

Technical data

Height Adjustment	approx. +10 / -5mm
Load (depending on the program)	max. 5kg
Area of use	Domestic
Drum speed, spinning	see rating plate
Water pressure	1-10bar (=10-100 N/cm ² = 0.1-1.0 Mpa)

Dimensions

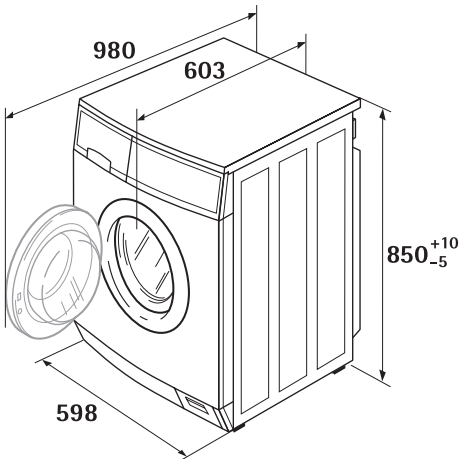

(dimensions in mm)

WARRANTY CONDITIONS

Great Britain

Guarantee Conditions

AEG offer the following guarantee to the first purchaser of this appliance.

1. The guarantee is valid for 12 months commencing when the appliance is handed over to the first retail purchaser, which must be verified by purchase invoice or similar documentation.
The guarantee does not cover commercial use.
2. The guarantee covers all parts or components which fail due to faulty workmanship or faulty materials. The guarantee does not cover appliances where defects or poor performance are due to misuse, accidental damage, neglect, faulty installation, unauthorised modification or attempted repair, commercial use or failure to observe requirements and recommendations set out in the instruction book.
This guarantee does not cover such parts as light bulbs, removable glassware or plastic, dust bags or filters.
3. Should guarantee repairs be necessary the purchaser must inform the nearest customer service office (manufacturer's service or authorised agent). AEG reserves the right to stipulate the place of the repair (i. e. the customer's home, place of installation or AEG workshop).
4. The guarantee or free replacement includes both labour and materials.
5. Repairs carried out under guarantee do not extend the guarantee period for the appliance. Parts removed during guarantee repairs become the property of AEG.
6. The purchaser's statutory rights are not affected by this guarantee.

European Guarantee

If you should move to another country within Europe then your guarantee moves with you to your new home subject to the following qualifications:

- The guarantee starts from the date you first purchased your product.
- The guarantee is for the same period and to the same extent for labour and parts as exist in the new country of use for this brand or range of products.
- This guarantee relates to you and cannot be transferred to another user.
- Your new home is within the European Community (EC) or European Free Trade Area.
- The product is installed and used in accordance with our instructions and is only used domestically, i. e. a normal household.
- The product is installed taking into account regulations in your new country.

Before you move please contact your nearest Customer Care Centre, listed below, to give them details of your new home. They will then ensure that the local Service Organisation is aware of your move and able to look after you and your appliances.

France	Senlis	+33 (0) 44 62 29 29
Germany	Nürnberg	+49 (0) 911 323 2600
Italy	Pordenone	+39 (0) 1678 47053
Sweden	Stockholm	+46 (0) 8 738 7910
UK	Slough	+44 (0) 1753 219899

INDEX

C

- Care agent 9, 17, 19
- Care symbols 16
- Child safety feature29, 34
- Circulation pump9, 28
- Conditioner 9, 11, 12, 19, 25
- Cottons10, 16, 24, 25
- Curtains15, 24
- Customer Service27, 51

D

- Delicates11, 16, 24, 25
- Detergent 9

E

- Easy-cares11, 16, 24, 25
- Emergency emptying 33
- Energy saving 24

F

- Filling quantity14, 24

G

- Gentle rinse12, 25

I

- In-wash stain treatment9, 19

L

- Linen10, 16, 24, 25

M

- Main wash10, 24

O

- OKO valve 14
- Opening the door 18, 23, 31

P

- Pre wash 10, 19, 24
- Pre-wash detergent9, 19
- Programme
 - changing 22
 - interrupting 22
 - setting20, 24
- Programme progress display 22
- Pump out 18, 22, 23

Q

- Quick wash 13, 20, 24

R

- Rating plate 9, 40, 41, 51
- Rinse 11, 25
- Rinse hold11, 18, 21, 22, 23
- Risk of frost 6, 33

S

- Service & Spare Parts51
- Silk16
- Soaking12, 19, 20, 23, 24
- Soaking agent 9, 19
- Spin 18, 21, 22, 25
- Stain13, 20, 24
- Starching11

W

- Warranty 6, 47
- Washing
 - coloureds15
 - heavily soiled13
 - lightly soiled 8, 13
 - sensitive16
- Washing powder9, 17, 19
- Washing powder drawer 9, 19
- Water
 - hardness17
 - pumping out18, 22, 23
 - softener9, 17, 19
- Woollens 11, 16, 24, 25

SERVICE & SPARE PARTS

If after carrying out the necessary checks there is still a fault with your appliance please contact your local AEG Service Force Centre.

In guarantee customers should ensure that the suggested checks have been made as the engineer will make a charge if the fault is not a mechanical or electrical breakdown.

Please note that proof of purchase is required for in-guarantee service calls.

Service & Spare Parts

If you require a service engineer or wish to purchase spare parts, contact your local AEG Service Force Centre, by telephoning:

0870 5 929 929

Help us to help you

Please determine your type of enquiry before telephoning. When you contact us we need to know.

1. Your name, address and post code.
2. Your telephone number.
3. Clear and concise details of the fault.
 - What is the fault?
 - When does the fault occur?
4. The model, production number and product identification number.
5. Date of purchase.

This information can be found on the rating plate, so you have these numbers to hand we recommend you write them below.

PNC

S-No.

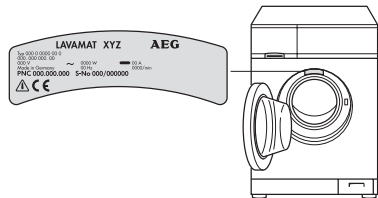

Customer Care

For general enquiries regarding your AEG appliance, or further information on AEG products please contact our customer care department by letter or telephone at the address below or visit our website at

www.aeghome.co.uk

Customer Care Department
 AEG Domestic Appliances
 55-77 High Street, Slough, Berkshire SL1 1DZ
 Tel: 08705 350350*

*Calls to this number may be recorded for training purposes.

The Electrolux Group is the world's largest producer of powered appliances for kitchen, cleaning and outdoor use. More than 55 million Electrolux Group products (such as refrigerators, cookers, vacuum cleaners, chain saws and lawn mowers) are sold each year to a value of approx. 14 billion USD in more than 150 countries around the world.



From the Electrolux Group. The world's No.1 choice.

AEG Hausgeräte GmbH
Postfach 1036
D-90327 Nürnberg

<http://www.aeg.hausgeraete.de>

© Copyright by AEG

822 942 537 -01- 0301-03