

# ÖKO\_LAVAMAT 538

The Environment-Friendly Washing Machine

Operating Instructions

## Hello

Allow me to introduce myself: I am your AEG ÖKO-LAVAMAT environment-friendly automatic washing machine. From now on, I should like to make washing easier for you, and not simply because of my attractive appearance, but also thanks to my "intrinsic qualities". I am economical in terms of energy, water, and detergent consumption, especially quiet in operation, easy to operate, and simple to care for.

**If you carefully read and follow my operating instructions before first use and familiarize yourself with my installation and connection instructions, you are sure to experience a good deal of joy when using me to wash your laundry!**



# Contents

<b>Safety instructions</b>	
Before first use	4
For the user	4/5
You should also note the following	5
<b>The ÖKO system</b>	6
<b>Out of concern for the environment ...</b>	
ÖKO tips for economical washing	7
The economy programmes	7
<b>Appliance description</b>	
Features	9–11
<b>How to machine-wash correctly</b> (brief instructions)	12
<b>Before starting to wash</b>	
Sorting your laundry	13
Pretreating your laundry	14
Care needed for certain fabrics	14
<b>Loading the laundry</b>	
Recommended wash loads	15
Open loading door	15
Insert laundry	15
Close loading door	15
<b>Detergents</b>	
Select detergent	16
Amount of detergent	17
Detergent dosage	18
<b>Setting the washing programme</b>	
Programme selector switch/programme cycle indicator/ Temperature selector switch	19/20
The buttons and their functions	21
<b>Programme tables</b>	22/23
<b>Consumption values</b>	24
<b>Programme end</b>	24
<b>Special accessories</b>	24
<b>Cleaning, maintenance, care</b>	25/26
<b>If you think your washing machine is not working properly ...</b>	27–30
<b>Customer service</b>	31
<b>Technical data</b>	32

## Safety instructions

### Before first use

- you should have noted my installation and connection instructions.
- you must have removed all parts of my transport packing. Unless removed, transport packing may lead to damage to the appliance and neighbouring furniture during the machine spin sequence.
- you should have run an initial washing cycle without laundry to remove residues of factory-applied grease on the laundry drum and suds tank. Programme: 60 °C coloureds with half a measuring beaker of detergent.

Small water residues which you may well find in my suds tank are due to the thorough test to which your machine was subjected in the factory.

### Safety instructions for the user

The safety of AEG electrical appliances conforms to the recognised rules of technology and the Appliance Safety Act. As manufacturers, we nonetheless feel obliged to familiarise you and any other persons using the machine with the following instructions:

- Please make sure before using your machine for the first time that the mains voltage and current type indicated on my rating plate agree with the mains voltage and current type where the machine is used. The necessary fusing is also indicated on the rating plate.
- Before cleaning, care, and maintenance work, make sure that the appliance is switched off. You will proceed safely if you first pull the mains plug out of the socket or, if your machine is connected by a fixed wiring connection, you switch off the FI protection switch or LP switch or completely remove the fuse (see installation and connection instructions).
- Never direct a water jet on to my outer casing.
- Never use my power lead to pull my plug out of the socket! Please take hold of my plug.
- Never operate me if:
  - the power lead is damaged, or
  - the appliance shows visible damage in the region of the control panel, worktop, or plinth.
- **Repairs to electrical appliances should only be performed by a trained electrician. Improper repairs may place the user at serious risk.**

If any other maintenance needs to be carried out, you are always recommended to contact our service centre or a repair shop authorised by ourselves. Only original AEG spare parts fulfill all requirements.
- If I am installed under a worktop in your kitchen or utility room, an intermediate earthed panel must be provided as protection against contact according to the installation and connection instructions when the worktop has been removed (see special accessories).

- Children may not recognise the dangers of improper use of electrical appliances. Please therefore ensure proper supervision during use.
  - When the day finally comes to withdraw me from service and to replace me with another machine, please make sure my lock is prevented from working, and cut my power lead off and remove it. Ensure the appliance is properly disposed of.
  - If I am wrongly operated or used for any purpose other than that for which I am intended, AEG cannot assume liability for any possible damage.
  - Do not climb on the appliance.
  - Small children must not be allowed to play inside the appliance.
  - Do not reach in to the drum while it is rotating.
  - When you wash with high temperatures, the glass of the loading door will become hot. Do not touch!
  - Opening the water pipes or channels, e. g. the fluff sieve, gives rise to danger from scalding.
  - In case of any fault, switch the appliance off (pull the plug out) and turn the water-tap off.
- 
- Please keep my packaging away from children. The foil represents a special source of danger. The packaging material meets ecological requirements and can be easily disposed off. You are advised to dispose of this material as quickly as possible.
  - Secure my drain hose with the hose holder against sliding off the sink or bath (see section on "Water drainage" in the installation and connection instructions).
  - If you machine-wash laundry precleaned with flammable solvents, these solvent must first have fully evaporated.
  - Never use me for chemical cleaning!
  - Colouring/colour removal agents may be used only if the manufacturer of these products expressly allows them for use in machine-washing in his instructions for use. No liability can be assumed for any consequential damage.
  - When cleaning my steel drum, never use any iron-containing scouring agents or steel wool!  
Also keep furniture polishes or aggressive cleansers away from my screen and control panel.
  - Use only tap water. Never use any other liquids. You may use rainwater only if it is completely clean, otherwise operation of my electrical solenoid valves could be disrupted.

**You should  
also note  
the following ...**

# My ÖKO system

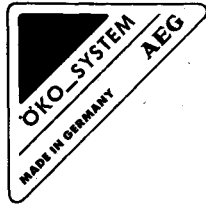

Your new ÖKO-LAVAMAT from the AEG ÖKO system meets all laundry care requirements and allows individual and versatile programme selection.

Highly economical water, energy, and detergent consumption contributes to relief of our environment and ensures maximum economic viability.

## The Öko lock

My ÖKO lock ensures 100 % detergent utilization through automatic closure of the suds tank during washing on all programmes and at all washing temperatures. This reinforces the cleaning effect and helps save detergent in comparison with machines without such a device.

## The scoop ribs

Scoop ribs arranged in my laundry drum continuously recirculate the water upwards, ensuring intensive and uniform soaking of your laundry.

## The automatic flowrate feature

The automatic flowrate feature automatically adjusts the water consumption to the wash load and fabric type concerned. By additionally pressing the economy button for small wash loads, you can save even more water.

I wish you great joy in taking economical and gentle care of your laundry!

## Appliance Packaging Information

All used materials are environmentally compatible. They can be safely disposed of or burnt in a refuse incinerator.

Regarding the materials: The plastics can also be recycled and are marked as follows:

>PE< for polyethylene e. g. as used in outer wrapping and bags inside;

>PS< for polystyrene foam e. g. as used in the packing; this material is basically CFC-free.

The cardboard parts are made of waste paper and should be put back into the waste paper collection system.

## Out of concern for the environment ...

These hints are intended to help you act in an environmentally conscious manner.

- For normally soiled laundry, the programmes are intended for use without prewash. In relation to a programme with prewash, you save detergent and water.
- Use full detergent containing a bleach additive only if the laundry is soiled by bleachable stains. Bleaches are especially effective at higher temperatures.
- You will obtain best consumption values with full wash loads.

If you find it necessary to wash small wash loads, however, you should use my  button. Then add only 2/3 to 1/2 of the amount of detergent needed for a full wash load. This will result in consumption of less water, energy, and detergent than for small wash loads in the normal programme.

- For light to normally soiled laundry, it is often sufficient to use my economy programme at a lower temperature than applied for a longer time.
- Through suitable pretreatment, stains and limited soiling can be removed. This saves a programme being used for heavily soiled laundry.
- Dose your detergent exactly as instructed by the detergent manufacturer. Overdosage wastes money and burdens the environment. You should also note the instructions for lightly soiled laundry.
- Detergent savings and care for the environment can also be achieved by dosing the detergent for soft water at medium to high water hardnesses and additionally adding a water softener. That relieves our aquifers somewhat of their "chemicals".
- Use fabric softeners only where necessary, e.g. for synthetic mixed fabrics, to avoid static charging. If you use a tumble dryer, your laundry will also be soft and fluffy even without a fabric softener.

### Here are my economy programmes:

-  – Programmes for half and even smaller wash loads.
- E** – Programmes for fabrics whose soiling does not require the full bleach action at high temperatures.

## ÖKO-tips for economical washing

## Economy programmes





## Appliance description

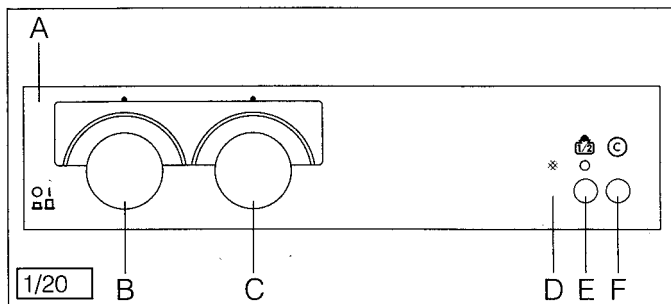

- A** Control panel
- B** 14-setting programme selector switch with programme cycle indicator
- C** Temperature selector switch
- D** Pilot lamp
- E** Small wash load button
- F** Cancel button

## Features

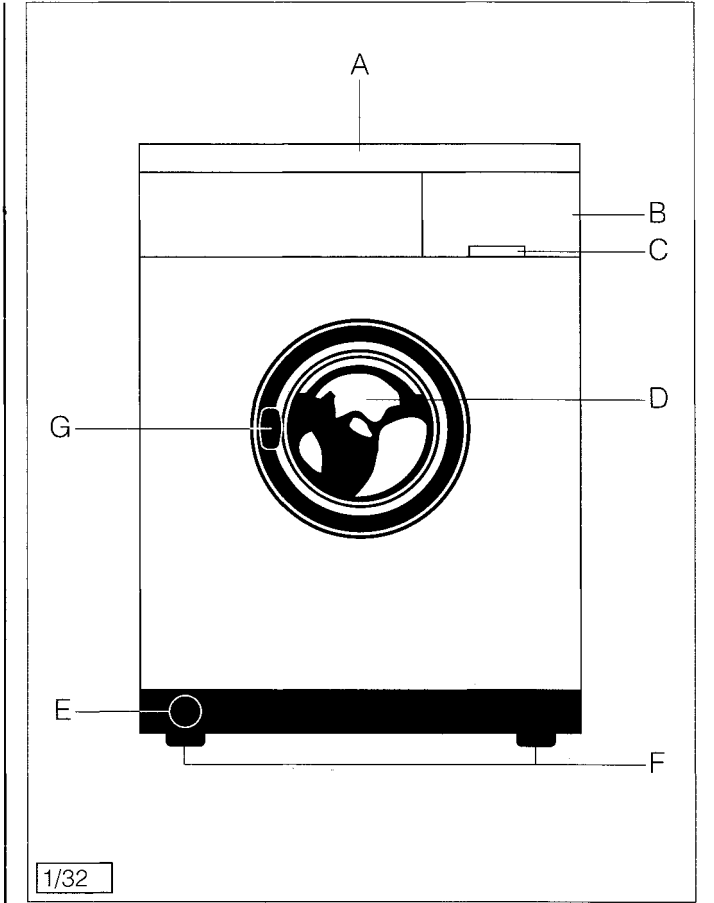

1/32

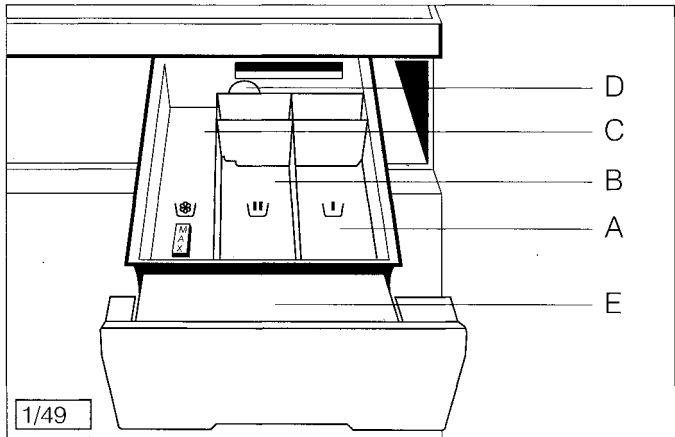

1/49

- A** Detachable worktop
- B** Dispenser with compartments for dosage of detergent and fabric conditioner and with inserted programme card printed on both sides, withdrawable
- C** Detergent dispenser handle
- D** Laundry loading door, opened via door release handle
- E** Drain pump (cover with debris trap opens for cleaning) – on LH side of latter, emergency drain hose
- F** 4 height-adjustable screw-in feet (front and rear)
- G** Door release

- 
- A** Prewash agent compartment
  - B** Detergent compartment for main wash
  - C** Liquid conditioner compartment (fabric softener, liquid conditioner, starch)
  - D** Siphon (must be securely inserted)
  - E** Programme card\*)

\*) You can re-order my programme card from your service centre if it ever gets lost.

## Features

### The dispenser for detergent and fabric conditioner

## How to machine-wash correctly (brief instructions)

### Preparing the laundry

Sorting  
Pretreatment  
Care needed for certain fabrics

### Loading the laundry

Open loading door  
Insert laundry  
Close door

### Detergent dosage

Select detergent  
Amount of detergent  
Add detergent/fabric conditioner  
Insert dispenser

### Selecting the washing programme

Set programme selector switch  
Set temperature selector switch  
Press additive buttons  
(see programme table or programme survey in dispenser)  
Pull programme selector switch. The programme starts.  
The pilot lamp lights up as soon as the loading door is  
locked.

### Continuing the programme

On programmes with rinse-stop , subsequently drain water  
from laundry:  
Set programme selector switch to 12 or 13 – see programme  
tables.

### When the programme has ended

Press in programme selector switch.  
Release depressed buttons with cancel button .  
Open loading door.  
Take out the laundry.

## Before starting to wash

- Check that the fabrics are machine-washable. The internationally valid care marks will give you guidance.

### Whites



### Coloureds



### Easy-care fabrics



### Delicates



### Woollens



- Woollens labelled only with the woolmark  are **not** suitable for machine-washing. Garments and woollens must be labelled with the woolmark and additionally marked “will not felt”, “non-felting”, or “machine-washable”.
- Unsuitable for machine-washing are garments marked with the following symbols:

### Hand wash



### Do not wash



- Note care instruction “Wash separately”.
- Coloureds and whites should never be washed together. In this case, whites will turn grey when washed. New dark-coloured laundry often has surplus colour. This may be transferred to lighter fabrics during washing. Such garments are best washed alone the first time.

## Sorting your laundry

## **Pretreating your laundry**

- Remove **stains** wherever possible immediately before they have soaked in, with water and soap, or a special detergent or laundry paste.

## **Care needed for certain fabrics**

### ■ **Empty pockets.**

Please make sure that no metal objects (e.g. paper clips, staples, safety pins, or the like) remain in the laundry.

Button up pillow cases, close zip-fasteners, hooks, and eyes. Tie together loose belts and long apron strings.

Turn knitted coloured garments, woolens, and bejewelled textiles inside out.

- **Particularly small or sensitive garments** (e.g. baby socks, ladies tights) can be easily washed in a small gauze bag with zip-fastener or in larger socks.

### ■ **Handle curtains especially carefully.**

When taking them off their rails when windows are open, you may damage or tear them (causing "ladders"). Remove rings from your curtains or enclose them in a net or bag.

Under no circumstances can we accept liability for such damage to curtains.

Spin curtains only when permitted by the manufacturer.

## Inserting your laundry

	Full load	Small loads
Whites/Coloureds normally soiled	5.0 kg	2.5 kg
heavily soiled	3.5 kg	1.8 kg
Easy-care fabrics and delicates	2.0 kg	1.0 kg
Woollens	1.0 kg	–
Short programme for whites/coloureds	2.5 kg	1.3 kg
Short programme for easy-care fabrics	2.0 kg	1.0 kg

Fill to the maximum recommended full load wherever possible, since this ensures optimum economy.

Do not overfill.

This will adversely affect the washing result.

With delicate easy-care washing liable to crease you should fill with less than the stated amount of water.

Pull the loading door handle forward.

- when the programme has ended and during the programme when my programme selector switch is pressed in and the locking time of 1–2 minutes has elapsed. When opening the door, **note the water level in the drum.**

Loosely load your laundry in the machine drum, mixing small and large items as much as possible. That reinforces the washing action and promotes distribution of the laundry during spinning. Load your laundry unfolded.

Press the door closed so that the catch clicks into position.

For your safety, my loading door is locked throughout the programme cycle. So long as my pilot lamp lights up when the machine is connected, the loading door cannot be opened.

### Wash loads (maximum dry wash loads)

### Opening and closing the laundry loading door To open:

### The loading door can be opened

### Loading

### To close: Safety lock

# Detergents

## Selecting your detergent

Use only detergents that are suitable for machine-washing. You will achieve the best cleaning action with a minimum of chemicals and with optimum laundry care by also considering the type of laundry soiling during your selecting of a suitable detergent.

Machine-washable soiling is basically classified into:

- **Dirt**, e. g. dust, soot, sweat, sebum, etc.
- **Stains**, e. g. tea, red wine, fruit, blood.

## Universal detergents

There are

- **Full-power washing powders** with bleach additive especially suitable for programmes with higher washing temperatures (60 °C and more), for heavily stained and soiled laundry.
- **Liquid detergents**, especially suitable for soiling by fats, e.g. sebum, cosmetics, and oil. Being bleach-free, they are less suitable for stained laundry.
- **BIO detergents**. Not all the products on the market, however, achieve the full washing performance.

## Special detergents

- **Detergents for coloureds and delicates**. They contain no bleach additives, and often no optical brighteners either, and are therefore gentle on colours.
- **Detergents for woollens** free from bleach additives and enzymes with an especially gentle effect on wool fibres.
- **Curtain detergents** containing light-fast optical brighteners to avoid yellowing due to the effect of sunlight.
- **Modular detergents** for the precise application of chemical substances according to fabric type, soiling, and water hardness.

## Washing aids

- **Water softeners** allow the use of smaller amounts of detergents in households having fairly hard, hard, or very hard tap water.
- **Pretreatment agent** for precise pretreatment of stains; its use enables any possible subsequent washing to proceed at a lower washing temperature or with bleach-free detergents.
- **Fabric softeners** prevent the static charging of synthetic fabrics and make your laundry soft to the touch. If you use a tumble dryer, your laundry will also be soft and fluffy without a fabric conditioner.
- **Starches, conditioning rinses, fine conditioners** ensure that your laundry keeps its shape and also make ironing easier.



## Amount of detergent

The amount of detergent used depends on the hardness range of your tap water. The harder the water, the more detergent must be dosed to bind the lime contained in the water. You will find dosage indications relating to water hardness on the detergent pack.

The water board serving the area you live in will give you information on its water hardness.

Water hardness		
Hardness range	°dH	mmol/l
I - soft	under 8	under 1.4
II - fairly hard	8-14	1.4-2.5
III - hard	15-21	2.6-3.7
IV - very hard	over 21	over 3.7

For only lightly soiled laundry, dose less. In this respect, follow the detergent manufacturer's instructions. If the latter gives no dosage indications for small loads, you should add 1/3 less for half wash loads and, for the smallest loads, only half the amount recommended for a full load.

You can save detergent and perceptibly relieve our aquifers somewhat of their "chemicals" by using a special softener at medium to high water hardnesses.

You should dose the special softener depending on the water hardness as instructed on the softener package. In this case, you should **always dose the detergent for "soft" hardness range I** as instructed on the detergent packages.

In this case, add the detergent and softener **together** in the main wash compartment. When using programmes with prewash, add it in the respective compartments for prewash and main wash.

## Dosing the detergent

The detergent dispenser has three compartments:

Compartment  = washing powder on programmes **without prewash** (right)

Compartment  = washing powder for main wash (centre)

Compartment  = liquid conditioner (conditioning rinse, starch) (left)

### Please also note the following:

## Dosing the powders

- When adding detergent and softener, fill **first detergent and then softener** in the same compartments.
- Stain salts/bleaching agents are always filled on the detergent.

## Dosing the liquids

- If you prefer **liquid detergents**, use the dosage measures offered throughout the detergent industry when adding them. Dose these agents as instructed by the manufacturer.
- When using liquid conditioners, follow the manufacturers' instructions.

## Dosing liquid conditioners

- Fill these agents **only up to the "MAX" mark**, since they will otherwise prematurely flow into the machine without any effect.
- **When using thick fabric conditioner concentrates and starches**, you are recommended to fill the compartment with water to below the "MAX" mark to ensure trouble-free dispensing after dosage.
- If you want to use **starch powder**, dissolve it according to the manufacturer's instructions and place the dissolved starch in compartment , selecting the "Conditioning – Starching" programme.

## Selecting the washing programme

Select my laundry programmes with the programme selector switch (Fig. 1/20 B), temperature selector switch (Fig. 1/20 C), and buttons (Fig. 1/20 E to F).

For laundry of average soiling, select a programme without prewash. For heavier soiling, select programme  with prewash or delicates programme 6.

My programme selector switch has 14 settings for the main and additional programmes. The programme with prewash is marked by the symbol , the other programmes by the figures 1 – 13 (see programme table).

The programme selector switch may only be turned **clockwise** and only **when the machine is switched off**.

The programme selector switch is also used to switch your machine on and off.

To switch on: Pull out the programme selector switch 

To switch off: Push in the programme selector switch 

You will also find the symbols opposite on the control panel.

My temperature selector switch features continuously variable setting to all necessary temperatures. On setting , you can wash cold, e.g. woollens.

In position **E**, you wash at a lower energy-saving temperature. If you wash at higher temperatures, the loading door window gets hot. Do not touch it!

### The programme selector switch

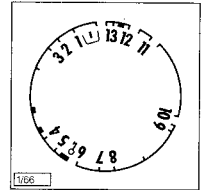

### Switching on and off



### The temperature selector switch

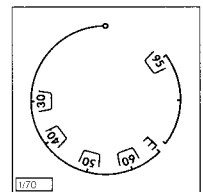

## The programme cycle indicator

During the programme cycle, the programme cycle indicator rotates step by step and indicates which part of the programme is then in progress.

In certain programme segments, the programme cycle indicator remains at rest for some length of time. In the "Woollens" programme, the laundry drum also remains at rest for some length of time.

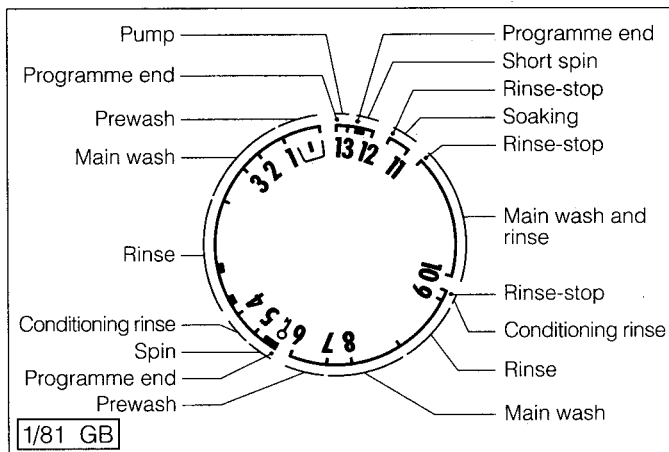

- - 5 Whites/coloureds
- 6 - 9 Easy-care fabrics/delicates
- 10 Woollens

By combining the main and additional programmes with my buttons, you will have a range of programmes meeting all your requirements.

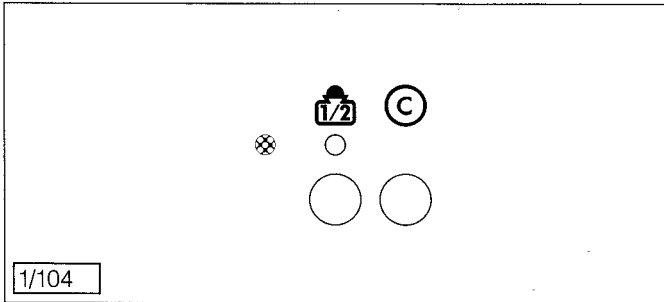

When the buttons are pressed, a red mark appears in the display above.

Effect:

- **For whites/coloureds and easy-care laundry**  
reduced water level during rinsing (water saving).
- **For delicates**  
reduced water level during washing and rinsing (water and energy saving)

This button has no effect for woollens.

Effect:

Depressed programme buttons are released.

## The button functions



























### Small wash loads













### Releasing the buttons



## Programme table

Care mark Laundry	Programme	Wash load	Programme setting Programme selector switch	Temperature selector switch
   Cotton/linen	Whites/ coloureds	up to 5 kg <sup>1)</sup>	1 <sup>2)</sup>	 ... 
 Cotton/linen	Energy- saving pro- gramme E	up to 5 kg <sup>1)</sup>	1 <sup>2)</sup>	E
   Finished cotton, mixed cotton fabrics, synthetics	Easy- care	up to 2.0 kg	7 <sup>2)</sup>	 ... 
 Synthetics/curtains	Delicates	up to 2.0 kg	7 <sup>2)</sup>	• ... 
  Woolens/mixed woolens, silk	Woolens	up to 1 kg	10	• ... 
   Cotton/linen	Coloureds Short wash	up to 5 kg	2	
			3	• ... 
   Easy-care/delicates	Easy-care Short wash	up to 2.0 kg	8	• ... 
Cotton/linen	Conditioning- rinse	up to 5 kg	4	-
Easy-care/delicates	Starching	up to 2.0 kg	9	-
Cotton/linen	Spin	up to 5 kg	5	-
Easy-care/delicates Wolle		up to 2.0 kg	12	-
	Prewash extra, soak	up to 3.5 kg	11	• ... 
	Pumping down		13	-

Programme cycle	Possible additional buttons	Instructions
Main wash – 4 rinses – final spin		The steps which you must take before each programme are given in the brief instructions
		
Main wash – 3 rinses – rinse-stop		<p>1) 3.5 kg for heavily soiled laundry</p> <p>2) With prewash button  on easy-care delicates programme 6</p> <p> = Rinse-stop</p>
Main wash at high water level, – 3 rinses – rinse-stop		The laundry remains in the last rinse water or in the soaking solution. You must pump down or spin your laundry.
Main wash at high water level, reduced drum action – 3 rinses – rinse-stop		
Reduced main wash – 4 rinses – final spin		
Reduced main wash – 3 rinses – rinse-stop		
Rinsing – pumping down – final spin		
Rinsing – rinse-stop		
Pumping down – final spin		
Pumping down – short spin		
Prewash extra/soak with high water level  . The washing can be left in the suds for any length of time.		
Pumping down, e. g. after rinse-stop		

## Consumption values and time requirement for selected programmes

Programme	Water consumption litres	Power consumption KWh	Time requirement minutes
Whites 95 °C, full wash-load	98	2.2	130
Easy-care laundry 60 °C, 2.0 kg wash-load	75	1.2	65
Woollens 40 °C, 1 kg wash-load	75	1.0	65

The values listed above were determined under normal conditions. Deviations up or down are possible under practical conditions.

On programmes with prewash (except woollens), the time requirement increases around 20 minutes.

### Programme end

As soon as the programme selector switch has been pressed in and the unlocking time of 1–2 minutes has elapsed, the loading door can be opened. Release any depressed buttons with release button C. Press in the programme selector switch. Your washing machine is switched off. Turn the temperature selector switch to the 0 position.

Take out the laundry.

Also check that my drum is completely empty, since fabrics may otherwise be damaged during the next wash (e.g. shrink) or discolour other laundry.

### Special accessories

Necessary when installing free-standing automatic washing machines under worktops.

The kit contains:

- Cover sheet with 2 fan discs as contact protection when the worktop is removed  
**The automatic washing machine without a worktop should now only be used after installation and earthing of the cover sheet as prescribed.**
- 2 sliding rails to assist insertion under worktops.
- Fume protection foil for protection of worktops in the region of the control panel and detergent dispenser.

**Open  
the door  
Switch off  
your machine**

**Build-under  
kit E-Nr.  
605 898 832**



## Maintenance and care

### Detergent dispenser

From time to time, you should clean my detergent dispenser of detergent residues.

- To do this, slightly lift the dispenser and pull it out with a jerk. Also detach the syphon in my special conditioner compartment (Fig.).

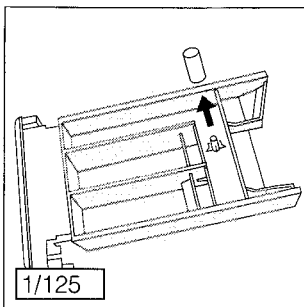

- Clean the dispenser compartments from the rear side, preferably with warm water and a bottle brush (Fig.).

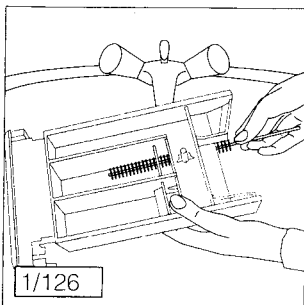

- Clean the syphon under running water. Re-insert the latter to its fullest extent. Check for proper seating.
- Clean the top of the detergent compartments with a brush.
- Re-insert the dispenser in the guides and push it in.
- At the end of the programme, pull the washing powder compartment out a little way so that it dries.

**Laundry drum**

My laundry drum is made of stainless steel. Any objects left in the laundry and likely to rust (see the section on "Preparing the laundry") may leave rust stains on the drum. These stains can be removed with a stainless steel cleaner. Your service centre stocks suitable products.

**Loading door**

Remove any deposits or foreign bodies from the rubber sleeve behind my loading door.  
The loading door should not be closed after washing, so that the laundry drum can dry out and the machine is thoroughly ventilated.

**Descaling**

If you have ensured the proper detergent dosage, your machine will hardly ever need to be descaled. If descaling should be necessary, use only branded descaling agents with corrosion protection for washing machines. Your service centre stocks suitable products.

**Screens and controls**

My control panel and its controls should be cleaned as necessary with luke-warm water only.

**Frost protection**

**Frost damage does not come under the guarantee!**  
If your ÖKO-LAVAMAT is installed in a room susceptible to frost, your machine must be subjected to emergency emptying as described in the section of "If you think your washing machine is not working properly ..." if there is any imminent risk of frost.  
Also, unscrew my supply hose from the water tap and allow the water to run out. Place a cloth underneath.

## **If you think your washing machine is not working properly ...**

### **... the laundry loading door will not immediately open when the programme is interrupted?**

- The door will open after 1–2 minutes (safety lock).
- A programme with rinse-stop has been selected.

### **... the washing machine is not working at all?**

- Your machine may well not be plugged in (the power plug may not be in the plug socket).
- The programme selector switch has not been pulled.
- The loading door is not properly closed.
- The fuse is not OK.

### **... no water runs in?**

- The water tap may well not have been turned on.
- One of the strainers in the water supply hose is choked. One strainer is located in the hose screw coupling on the water tap: unscrew the supply hose and clean the strainer under running water. A second strainer is located in the machine connection union. Unscrew the supply hose on the machine and clean the strainer.

### **... the spin sequence starts with some delay?**

- The electronic imbalance monitoring system of your machine has been set off by poor laundry distribution. Your laundry should be loosened and better distributed by the to and fro action of the drum and the spin sequence restarted. This may happen several times until the imbalance is corrected and the spin sequence can finally start.

### **... the washing machine vibrates?**

- Very small wash loads (e.g. only one bathrobe) may possibly cause your machine to vibrate. This does not affect operation of your machine in any way. The appliance feet are not properly adjusted. See Instructions for Installation.

### **... the washing machine makes unusual noises?**

- This washing machine possesses a modern drive system, which in comparison with earlier drives produces a different kind of noise, rather like a whistle. The new drive allows the washing machine to build up speed gently when spin-drying, and to then keep to the speed-level set. The washing machine's stability has thereby been improved and its water-consumption lowered.

### **... the suds froths too much in the main wash?**

- You have added too much detergent. Dose the detergent more accurately.

### **... the washing machine does not keep still?**

- The drain hose may well be kinked, or
- The suds pump is choked. In both cases, the water has been pumped away insufficiently or perhaps not at all. See also "Cleaning the suds pump".

**Minor faults  
you can  
rectify  
yourself**

- There may well still be transport packing in your washing machine, or your machine has not been properly installed and tilts from side to side.

Check the Installation Instructions.

... **water runs out from under the machine?**

- The hose screw coupling on the supply hose or the hose clip in the drain hose may well be loose.
- The supply hose or the drain hose is leaking.
- The cover of the suds pump in the plinth (Fig. 1/32 E) has not been properly reconnected after cleaning or emergency emptying. See "Cleaning the suds pump", in this section.

... **the laundry has not turned out as well as it usually does?**

- You have added too little detergent.  
Underdosage leads to greying of your laundry and to scaling in your machine.  
Ensure more accurate dosage.
- You may well also have not used the correct detergent.
- Special soiling has not been pretreated.
- Have you correctly selected the programme and temperature?
- Also check whether, when using "modular detergents", you made the correct choice for the type of soiling concerned.

... **the conditioning rinse was not dispensed and the conditioner compartment is filled with water?**

- The syphon in the compartment is not correctly inserted or is choked. See "Maintenance and care".
- The washing powder compartment has been pulled out when it should have been dispensing.

... **despite pretreatment, stains are not removed during washing?**

- The stains may possibly not be washable. Consult specialist (dry cleaners).

... **grey residues ("flecks") are found on the finished laundry (so-called greasy smudges)?**

- Laundry soiled by ointments, fats, or oils, e.g. sick-bed laundry, has been washed with too little detergent, so that the amount of detergent has been insufficient to dissolve the fat. Add more detergent.
- Your laundry has been washed at too low a temperature.

... **even after the final rinse sequence (rinse-stop), foam is still visible?**

- Modern detergents cause frothing even in the final rinse water, which, however, has no effect whatever on the rinsing result.

... **conditioner flecks remain on the finished laundry?**

- This is in most cases likely to be due to the fact that conditioning rinse – especially that in concentrated form – has directly affected your laundry.

Wash out these flecks as quickly as possible, and take care when handling these agents!

... **white detergent residues remain on the laundry after the programme has ended?**

- These residues mostly refer to insoluble constituents of modern detergents. They are not due e.g. to insufficient rinsing. Possible remedies: Brush or shake out, or possibly also turn garments inside out for washing. Check detergent selection.

... **no water can be seen in the port-hole?**

- Modern washing machines work very economically, with such small quantities of water that it is sometimes not visible through the port-hole. Nevertheless, the machine still washes and rinses perfectly.

... **the laundry is insufficiently spun or water remains in the drum?**

- Owing to a kinked hose, the pump is delivering too little water from your washing machine.
- The pump head of max 1 metre has been exceeded. For such cases, the service centre stocks a retrofitting kit with a second pump.
- The suds pump is choked.  
Proceed as follows when cleaning the suds pump:
  - **Unplug your washing machine or take out the fuse.**
  - Drain the water from the machine as described under "Emergency emptying in the event of a power failure" in the next section.
  - Unscrew the suds pump cover anticlockwise (see arrow) and remove together with the insert, placing a cloth underneath beforehand, since residual water may still run out.

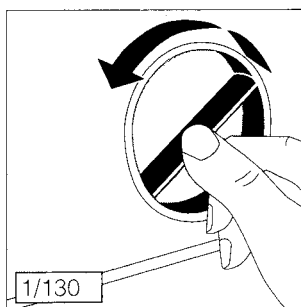

- Remove foreign bodies from the pump housing. Always also check by hand that the pump impeller runs easily.
- Re-insert the cover and firmly screw on clockwise – otherwise water will run out.

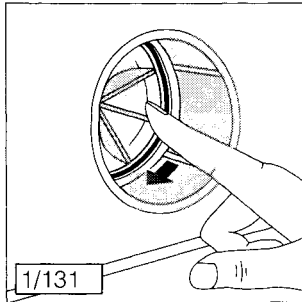

- Close and insert emergency emptying hose with plug A. Fix the plug by rotating it one quarter revolution in a clockwise direction.

... **the washing machine no longer pumps water away and a high water level can be seen in the window?**

■ Proceed as follows:

- Turn plug A one quarter revolution in an anticlockwise direction (in the direction of the arrow) to its fullest extent. Pull out hose B and remove plug A.

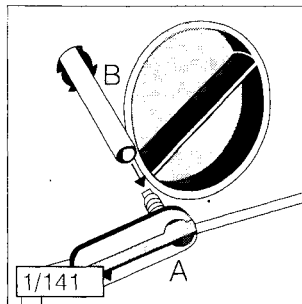

- Allow the residual water to drain into a bowl (place a cloth underneath). Depending on the amount of residual water, it may be necessary to empty the collecting bowl several times. **Take care if the suds are hot!** Where necessary, allow to cool first.
- Reclose hose B with plug A.
- Re-insert plug A with hose B and screw tight.

**Please note:**

After emergency emptying, your automatic washing machine has been fully emptied.

To ensure the function of my ÖKO lock, it is necessary to add around 1/2 litre of water in my detergent dispenser after re-inserting emergency emptying hose B.

If, however, you decide to call the service centre to help with any of the stated instructions or because of faulty operation, a charge will have to be made for the service engineer's visit even during the guarantee period.

## Customer service

If you find no reference to any particular fault in my Operating Instructions, please contact the service centre.

When doing so, quote the product number (E-No.) and serial number (F-No.) of your machine. You will find these numbers on my rating plate.

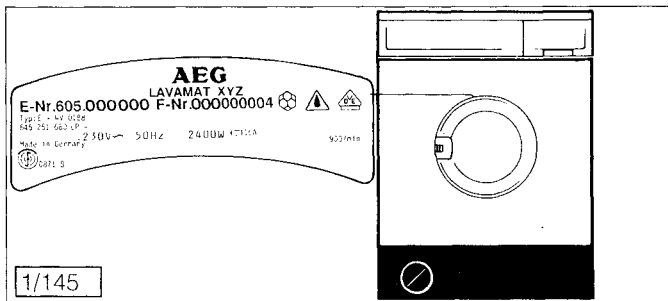

Your indication of these numbers enables the service centre to make precise identification of the required spare part so that your washing machine can be repaired at the engineer's first visit. You will thus save yourself additional costs due to any possible repeated trips by the service engineer.

To keep these numbers handy, we recommend you to enter them here:

**E-No.** .....

**F-No.** .....

## Technical data

### Dimensions:

with worktop

Height 85.0 cm

Width 60.0 cm

Depth 60.0 cm

Without worktop

Height 82.0 cm

Width 59.5 cm

Depth 57.0 cm

### Connection

Data on electrical connection are given on the rating plate. If your machine is of the convertible type, you should additionally follow the instructions given in the conversion chart on the junction box on the machine back panel.

When connecting the machine, you must make sure that the nominal voltage and current type indicated on the rating plate are the same as the nominal voltage and current type at the installation site.

### Drum speeds

Washing 50 min<sup>-1</sup>

Rinsing max. 800 min<sup>-1</sup>

### Water pressure:

1 - 10 bar (= 10 - 100 N/cm<sup>2</sup> = 0.1 - 1.0 MPa)

### Weight empty:

Around 80 kg

This appliance meets the radio/tv suppression requirements of EN 55014 / DIN VDE 0875 Part 1, Directives 82/499 EC, 87/308 EC, and EN 55011, DIN VDE 0871 Part 1, as well as the standard for reciprocal effect on electricity mains EN 60555 Parts 1-3 / VDE 0838 Parts 1-3 of June 1987.

## AEG Domestic Appliances Ltd

Customer Care Department

55-77 High Street

Slough

Berkshire SL1 1DZ

Telephone: 08705 350350