

ÖKO_LAVAMAT 600 digitronic

The Environment-Friendly Washing Machine

Operating Instructions

Congratulations

You are the owner of a high quality and environment-friendlier ÖKO-LAVAMAT washing machine from AEG.

From now on washing and caring for your clothes should be easier for you, not simply because it is easy to use, but also because it has "intrinsic features and qualities" which make the task easier. ÖKO-LAVAMAT washing machines are economical in terms of energy, water and detergent consumption, they are also extremely quiet in operation, easy to use and simple to care for.

Please read these instructions prior to using the appliance and retain them for future reference.



Contents

Safety instructions	
Before first use	4
For the user	4/5
You should also note the following	5
The ÖKO system	6/7
Out of concern for the environment . . .	
ÖKO tips for economical washing	8
The economy programmes	8
Appliance description	
Features	9-11
Brief instructions on machine washing	12
Before starting to wash	
Sorting your laundry	13
Pretreating your laundry	14
Care needed for certain fabrics	14
Loading the laundry	
Recommended wash loads	15
Open loading door	16
Loading laundry	16
Close loading door	16
Detergents	
Select detergent	17
Amount of detergent	17
Adding detergent	18
Selecting the wash programme	
Programme selector/programme cycle indicator/ Temperature selector	19/20
The buttons and their functions	21
Programme tables	22/23
Programme end	24
Special accessories	24
Cleaning, maintenance, care	25/26
If you think your washing machine is not working properly . . .	26-30
Customer service	31
Technical data	32

Safety instructions

Before first use . . .

- Please note the installation and connection instructions.
- Please ensure you have removed all the transport packing. Unless removed, transport packing will cause damage to the appliance and adjacent furniture during spinning.
- You should run an initial wash cycle without laundry to remove residues of factory-applied grease from the drum and tub. Programme: 60°C cotton programme with half a measure of detergent.

You may find small water residues in the tub, these are due to the thorough testing which your machine was subjected to in the factory.

Safety instructions for the user

AEG electrical appliances conform to the recognised safety regulations governing electrical domestic appliances. As manufacturers, we nonetheless feel obliged to familiarise you and any other persons using the machine with the following instructions:

- Please make sure before using your machine for the first time that the mains voltage and supply indicated on the rating plate agree with the mains voltage where the machine is to be used. The fuse required is indicated on the rating plate.
- Before cleaning, care and maintenance work, make sure that the appliance is switched off. We advise for safety reasons that you pull the mains plug out of the socket, switch off at the power point or completely remove the fuse in the fuse box servicing this circuit. (See installation and connection instructions.)
- Never direct a water jet onto the outer casing!
- Never use the supply lead to pull the mains plug out of the socket!
- Never operate the machine if:
 - the mains supply lead is damaged, or
 - the appliance shows visible damage to the control panel, worktop, or plinth.
- **Repairs to electrical appliances must only be performed by a trained electrician. Improper repairs may place the user at serious risk.**

If any other maintenance needs to be carried out, contact our service centre or AEG authorised service agents. Only original AEG spare parts fulfill all requirements!
- If the machine is installed under a worktop in your kitchen or utility room, i.e. the worktop has been removed, and an earthed cover plate must be fitted as protection according to the installation and connection instructions. (See special accessories.)
- Children may not recognise the dangers of improper use of electrical appliances. Therefore, please ensure proper supervision when the machine is in use.

- When the day finally comes to withdraw the machine from service and to replace it with another machine, please make sure that you inactivate the door lock and cut the electrical supply lead, disposing of lead and plug safely. This will prevent children from locking themselves in, thus endangering their lives. Ensure safe disposal of the appliance.
 - If the machine incorrectly operated or used for any purpose other than that for which it is intended, AEG cannot assume liability for any possible damage.
 - Do not climb on the appliance.
 - Keep small children from climbing into the machine to play hide and seek.
 - Do not reach into the moving drum.
 - When you wash with high temperatures, the glass of the loading door will become hot. Do not touch!
 - If the appliance is opened by force or through the emergency drain during operation, very hot water can result in scalding.
 - In case of faults, switch the appliance off, remove the plug from the socket and turn the water supply to the machine off.
-
- Please keep the packaging away from children. The foil represents a particular danger. The packaging material meets ecological requirements and can be easily disposed of. You are advised to do this as quickly as possible.
 - If the machine is not permanently connected: hook the drain hose securely over the edge of the sink using the hose holder provided. (See section on "Water drainage" in the installation and connection instructions.)
 - If your laundry has been pre-cleaned with flammable solvents, these solvents must have fully evaporated before placing the laundry in the machine.
 - Never use the machine for chemical cleaning!
 - Dyes/dye removal agents may only be used if the manufacturer of these products expressly allows them to be used in automatic washing machines. Please see their instructions for use. No liability can be assumed for any consequential damage.
 - When cleaning the stainless steel drum, never use any iron-containing scouring agents or steel wool!
Keep furniture polishes or abrasive cleaners away from the control panel and the controls.
Only use tap water. Never use any other liquids. You may use rainwater only if it is completely clean, otherwise operation of the electrical solenoid valves could be impaired.

**You should
also note the
following ...**

The ÖKO System



Your new ÖKO-LAVAMAT meets all laundry care requirements and allows individual and versatile programme selection. It is highly economical in water, energy and detergent consumption, which not only contributes to protection of our environment, but also saves you money.

The Special Spin System

The electronically controlled spin with intermediate spins after the main wash and the 3 rinse sequences on the cotton and linen programmes guarantees very low water consumption:

The ÖKO Lock

The ÖKO lock ensures 100% effective detergent utilisation. The ÖKO valve closes off the wash tub from the drainage system during all wash programmes. This not only reinforces the cleaning effect but also saves detergent – a saving of 20% in comparison with machines without such a device.

The Stream Clean

The special AEG wash paddles carefully scoop up the wash solution, and on reaching the top of the drum, gently spray streams of water through your wash load. This system ensures that your laundry is at all times soaked in the wash solution.

The Automatic Flowrate Feature

The automatic flowrate feature automatically adjusts the water consumption to the wash load and fabric type concerned. By additionally pressing the ½ load button for small wash loads, you can save even more water.

The Short Programmes

For lightly soiled and small wash loads, eg in the case of sports and leisure clothing, use the short programmes.

The Wool Cradle

The wool cradle takes special care of your woollens: with a very gentle washing action, these especially sensitive garments are gently "rocked" to and fro in the drum.

The packaging material meets ecological requirements and can be easily disposed of or can be burned safely in the municipal incinerators.

To the materials: the plastics can be recycled and are marked as follows:

> **PE** < for Polyethylene, e.g. the outer wrapping and the bags inside.

> **PS** < for blown (CFC free) Polystyrene, e.g. the fillers.

The cardboard parts have been manufactured from recycled material and should be taken for recycling again.

Information on the packaging material of the appliance

Out of concern for the environment . . .

ÖKO Tips for Economical Washing

These hints are intended to help you act in an environmentally conscious manner.

- For normally soiled laundry, the programmes are intended for use without prewash. Compared to a programme with prewash, you save detergent and water.
- Use full detergent containing a bleach additive only if the laundry is soiled by bleachable stains. Bleaches are especially effective at higher temperatures.
- It is more economical to wash full loads. If you find it necessary to wash small loads, you should use the  button. Add only 2/3 to 1/2 of the amount of detergent for a full load. This will result in consumption of less water, energy and detergent.
- For light to normally soiled laundry, it is often sufficient to use the economy programme, ie at a lower temperature for a longer time.
- With suitable pretreatment, stains and limited soiling can be removed. This saves a programme being used for heavily soiled laundry.
- Dose your detergent exactly as instructed by the detergent manufacturer, bearing in mind that because of the ÖKO lock you can use 20% less. Overdosage wastes money and burdens the environment. You should also note the instructions for lightly soiled laundry.
- Detergent savings and care for the environment can also be achieved by dosing the detergent as for soft water although you have medium to high water hardnesses, and additionally adding a water softener. This reduces the amount of "chemicals" entering our water ways.
- Use fabric softeners only where necessary, eg for synthetic or mixed fabrics, to avoid static. If you use a tumble dryer, your laundry will be soft and fluffy without a fabric softener.

Economy Programmes

Economy programmes:

-  – Programmes for half and small wash loads
- E** – Programmes for fabrics where soiling does not require the full programme at a high temperature

Appliance description

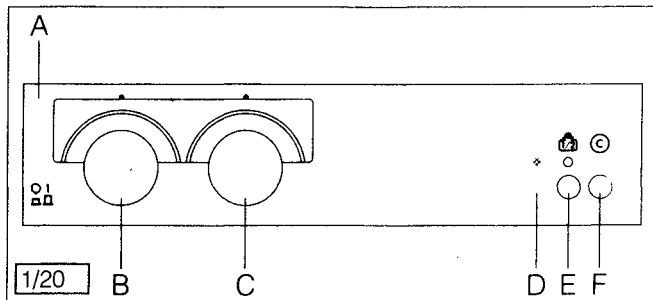

- A** Control panel
- B** 14-setting programme selector with programme cycle indicator
- C** Temperature selector
- D** Pilot lamp
- E** Small wash load button
- F** Cancel button

Features

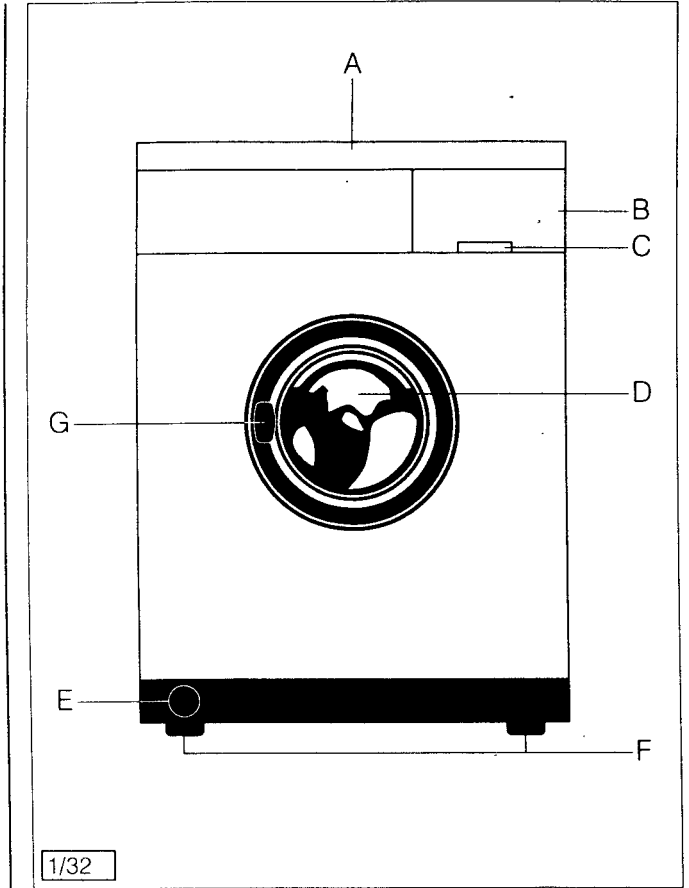

1/32

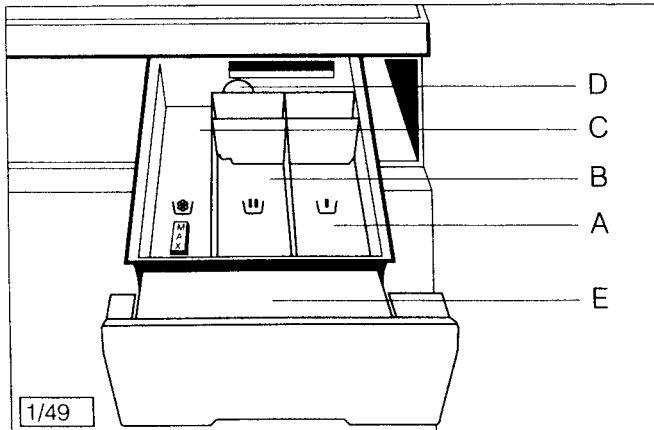

1/49

- A** Removable worktop
- B** Dispenser with compartments for detergent and fabric conditioner and with removable programme card printed on both sides
- C** Detergent dispenser handle
- D** Laundry loading door, opened via door release handle
- E** Drain pump (cover with debris trap opens for cleaning) – on LH side of pump cover, emergency drain hose
- F** 4 height-adjustable screw-in feet (front and rear)
- G** Door handle

Features

-
- A** Prewash detergent compartment
 - B** Detergent compartment for main wash
 - C** Liquid conditioner compartment (fabric softener, liquid conditioner, starch)
 - D** Siphon (must be securely inserted)
 - E** Programme card*)

The dispenser for detergent and fabric conditioner

*) You can re-order the programme card from your service centre if it ever mislaid.

Brief instructions on machine washing

Preparing the laundry

Sorting
Pretreatment
Care needed for certain fabrics

Loading the laundry

Open loading door
Distribute laundry in the drum
Close door

Detergent dosage

Select detergent
Measure amount of detergent
Add detergent/fabric conditioner
Close dispenser

Selecting the wash programme

Set programme selector
Set temperature selector
Press option buttons
(see programme table or programme card in dispenser)
Pull out programme selector. The programme starts. The pilot lamp lights up as soon as the loading door is locked.

Continuing the programme

On programmes with rinse-hold , to drain water from laundry:
Set programme selector to 12 or 13 – see programme tables.

When the programme has finished

Push in programme selector.
Release depressed buttons with cancel button .
Open loading door.
Take out the laundry.

Before starting to wash

- Check that the fabrics are machine-washable. The international care labels will give you guidance.
- Woollens labelled only with the woolmark  are **not** suitable for machine-washing. Also garments marked with the following symbols:

Hand wash



Do not wash



Sort your laundry into laundry types as follows, separating coloureds from whites.:

Cotton/linen – Whites



Cotton/linen – Coloureds



Easy-care fabrics



Delicates



Woollens



- Woollens must be labelled with the woolmark and additionally marked “will not felt”, “non-felting”, or “machine-washable”.
- Coloureds and whites should never be washed together, whites will turn grey.
New dark coloured laundry will often state “wash separately”. This type of garment will often have surplus colour which may be transferred to lighter fabrics during washing. Always wash such items on their own for the first few washes.
- You may also see the following labels. They are not common in the UK, but are widely used in garments manufactured in the rest of Europe.

White cottonarticles with special finishes



White nylon and white polyester cotton



This label may be found in a variety of garments – the articles should be laundered



on the wool programme.

Sorting your laundry

Pretreating your laundry

- Wherever possible remove **stains** immediately, before they have set, with water and soap or with a special pretreatment agent (spray, liquid detergent).

Care needed for Certain Fabrics

■ **Empty pockets**

Please make sure that no metal objects (eg paper clips, staples, coins, safety pins, or the like) remain in the laundry.

Button up pillow cases, close zip-fasteners, hooks and eyes. Tie together loose belts and long apron strings.

Turn coloured knitted garments inside out.

- **Particularly small or sensitive garments** (eg baby socks, ladies tights, etc) should be washed in a launder net bag or pillowcase.

■ **Handle curtains especially carefully**

Remove rings and hooks from your curtains, to avoid damage or tearing. Synthetic curtains should be handled carefully as they snag easily. Place net curtains in a pillowcase or wash bag.

Under no circumstances can we accept liability for damage to curtains through incorrect handling.

Spin curtains only when permitted by the manufacturer.

Loading your laundry

	Full load	Small loads
Cotton/linen – Whites/coloureds normally soiled	5.0 kg	2.5 kg
heavily soiled	3.5 kg	1.8 kg
Easy-care fabrics and delicates	2.0 kg	1.0 kg
Woollens	1.0 kg	–
Short programme for whites/coloureds	2.5 kg	1.3 kg
Short programme for easy-care fabrics	2.0 kg	1.0 kg
Extra pre-wash-soak	3.5 kg	1.8 kg

Use the recommended full load wherever possible, as this is the most economical way to wash.

But do not overload!

This will adversely affect the wash result. When washing easy-care fabrics susceptible to creasing, reduce the load.

Information for Test Institutes

For tests similar to IEC 456 (new) using standard load A, the maximum load is 4.5 kg.

**Wash loads
(maximum dry
loads)**

Opening and closing the loading door
To open:

Pull the loading door handle forward.

The loading door can be opened

- when the programme has finished and during the programme when the programme selector is pushed in and the locking time of 1-2 minutes has elapsed. When opening the door, **beware of the water level in the drum.**

Loading

Loosely load your unfolded laundry in to the machine drum, mixing small and large items as much as possible. This reinforces the washing action and promotes even distribution of the laundry during spinning.

To close:

Press the door closed so that the catch clicks into position.

Safety lock

For your safety, the loading door is locked throughout the programme cycle. So long as the pilot lamp is on when machine is connected, the loading door cannot be opened.

Detergents

Use only detergents that are suitable for automatic washing machines.

You will achieve the best cleaning results with minimum harm to the environment by also considering the type of laundry soiling when selecting a suitable detergent.

Machine-washable soiling is basically classified as:

- **Dirt**, e.g. dust, soot, sweat, grease, etc.
- **Stains**, e.g. tea, red wine, fruit, blood

You will find BIO and NONBIOLOGICAL detergents in powder or liquid forms. Check with the detergent manufacturers information as to which detergent suits your purposes best bearing in mind that the detergent must be a low lather one suitable for automatic washing machines! **We recommend ARIEL (in the various different forms) and Dreft automatic for woollens.**

- **Water softeners** allow the use of smaller amounts of detergents in households having medium-hard to very hard tap water.
- **Fabric softeners** prevent the static charging of synthetic fabrics and make your laundry soft to the touch. If you use a tumble dryer, your laundry will be soft and fluffy without a fabric conditioner. We recommend LENOR fabric conditioner.
- **Starches, conditioning rinses**, ensure that your laundry keeps its shape.

The amount of detergent used depends on the hardness range of your tap water. With an increasing water hardness, more detergent must be dosed to bind the lime contained in the water. You will find dosage indications for soft or hard water on the detergent pack. For lightly soiled laundry, use less detergent. Follow the detergent manufacturers instructions. If the latter gives no dosage indications for small loads, you should reduce by $\frac{1}{3}$ for half wash loads and for even smaller loads use $\frac{1}{2}$ the amount recommended for a full load. You can save detergent and prevent unnecessary amounts of detergent from entering our waterways by using a special water softener in areas with hard water.

You should dose the special softener depending on the water hardness as instructed on the softener package. In this case, you should **always dose the detergent for "soft" water** as instructed on the detergent packages.

In this case, add the detergent and softener **together** in the main wash compartment. When using programmes with prewash, add it to the respective compartments for prewash and main wash.

Selecting your detergent

Detergents

Washing aids

Amount of detergent

Dosing the detergent

The detergent dispenser has three compartments:

Compartment (right)  = washing powder for programmes **with prewash**

Compartment (centre)  = washing powder for main wash

Compartment (left)  = liquid conditioner (conditioning rinse, starch)

Please also note the following:

Dosing powders

- When adding detergent and water softener, fill **first detergent and then softener** in the same compartments.
- Stain salts/bleaching agents are always filled on the detergent.

Dosing liquids

- If you prefer **liquid detergents**, dose these agents as instructed by the detergent manufacturer, using the “balls” supplied or offered by the detergent manufacturer.
- When using liquid, follow the manufacturers's instructions.

Dosing fabric conditioners

- **Do not fill above “MAX”** indicator level as otherwise the liquid may drain immediately.
- **When using thick concentrated fabric conditioner and starches**, you are recommended to mix the concentrate with water to ensure troublefree dispensing.
- If you want to use **starch powder**, dissolve according to the manufacturers's instructions and place in compartment , selecting the “Fabric conditioning – Starching” programme.

Practical Hint

Modern detergents work very well at lower temperatures, helping with the fabric care and also reducing your electricity bills.

To maintain your washing machine in the best working order and minimise any chance of mould forming on the appliance interior, we recommend that you wash at least one cotton load at 60 °C per week using a full strength detergent such as Ariel Ultra. In this way, the hotter wash temperature will help clean and maintain the machine.

Selecting the washing programme

Select the laundry programmes with the programme selector switch (fig. 1/20 B), temperature selector switch (fig. 1/20 C), and buttons (fig. 1/E to F).

For laundry of average soiling, select a programme without prewash. For heavier soiling, select programme  with prewash or for delicates, programme 6.

The programme selector switch has 14 settings for the main and additional programmes. The programme with prewash is marked by the symbol , the other programmes by the figures 1 - 13 (see programme table).

The programme selector switch may only be turned **clockwise** and only **when the machine is switched off**.

The programme selector switch is also used to switch your machine on and off.

To switch on: Pull out the programme selector switch 

To switch off: Push in the programme selector switch 

You will also find these symbols on the control panel.

The temperature selector switch features continuously variable setting to all necessary temperatures. On setting , you can wash cold, e.g. woollens.

In position **E**, you wash at a lower energy-saving temperature. If you wash at higher temperatures, the loading door window gets hot. Do not touch it!

The programme selector switch

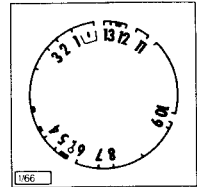

Switching on and off



The temperature selector switch

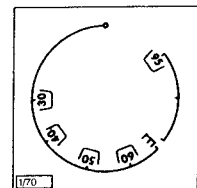

The programme cycle indicator

During the programme cycle, the programme cycle indicator rotates step by step and indicates which part of the programme is then in progress.

In certain programme segments, the programme cycle indicator remains at rest for some length of time. In the "Woollens" programme, the laundry drum also remains at rest for some length of time.

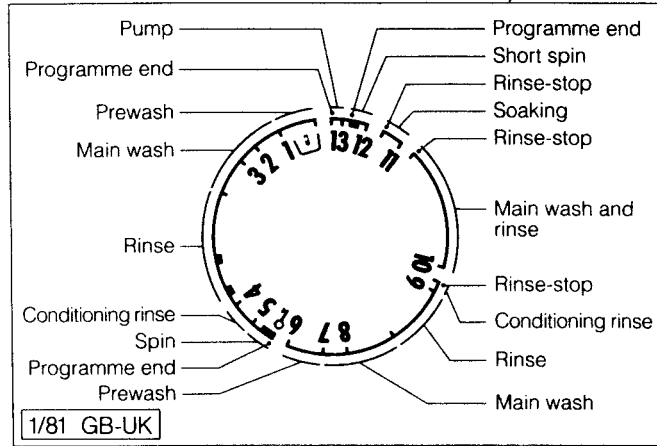

-  - 5 Whites/coloureds
- 6 - 9 Easy-care fabrics/delicates
- 10 Woollens

By combining the main and additional programmes with the buttons, you will have a range of programmes meeting all your requirements.

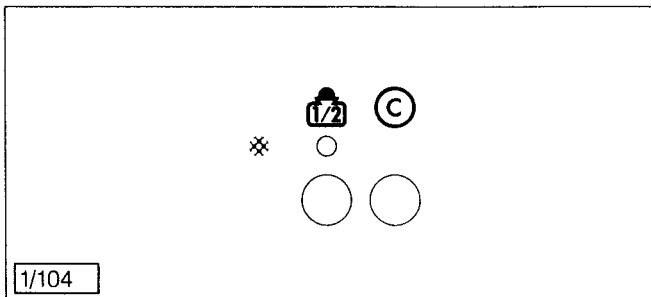

When the buttons are pressed, a red mark appears in the display above.

Effect:

■ **For whites/coloureds and easy-care laundry**

reduced water level during rinsing (water saving).

■ **For delicates**

reduced water level during washing and rinsing (water and energy saving).

This button has no effect for woollens.

Effect:

Depressed programme buttons are released.

The button functions



























Small wash loads



















Releasing the buttons



Programme table

Care mark Laundry	Programme	Wash load	Programme setting Programme selector switch	Temperature selector switch
   Cotton/linen	Whites/ coloureds	up to 5 kg ¹⁾	1 ²⁾	 ... 
 Cotton/linen	Energy saving programme E	up to 5 kg ¹⁾	1 ²⁾	E
   Finished cotton, mixed cotton fabrics, synthetics	Easy-care	up to 2 kg	7 ²⁾	 ... 
 Synthetics/curtains	Delicates	up to 2 kg	7 ²⁾	● ... 
  Woollens/mixed woollens, silk	Woollens	up to 1 kg	10	● ... 
   Cotton/linen	Coloureds Short wash	up to 5 kg	2	
			3	● ... 
   Easy-care/delicates	Easy-care Short wash	up to 2 kg	8	● ... 
Cotton/linen	Conditioning- rinse	up to 5 kg	4	–
Easy-care/delicates	Starching	up to 2 kg	9	–
Cotton/linen	Spin	up to 5 kg	5	–
Easy-care/delicates Woollens		up to 2 kg	12	–
	Prewash extra, soak	up to 3.5 kg	11	● ... 
	Pumping down		13	–

Programme cycle	Possible additional buttons	Instructions
Main wash – 4 rinses – final spin	  500 (if available)	<p>The steps which you must take before each programme are given in the brief instructions</p>
	  500 (if available)	
Main wash – 3 rinses – rinse-stop		<p>1) 3.5 kg for heavily soiled laundry</p>
Main wash at high water level, – 3 rinses – rinse-stop		<p>2) With prewash button  on easy-care delicates programme 6</p> <p> = Rinse-stop</p>
Main wash at high water level, reduced drum action – 3 rinses – rinse-stop		<p>The laundry remains in the last rinse water or in the soaking solution.</p>
Reduced main wash – 4 rinses – final spin	  500 (if available)	<p>You must pump down or spin your laundry.</p>
Reduced main wash – 3 rinses – rinse-stop		
Rinsing – pumping down – final spin	  500 (if available)	
Rinsing – rinse-stop		
Pumping down – final spin	 500 (if available)	
Pumping down – short spin		
Prewash extra/soak with high water level  . The washing can be left in the suds for any length of time.		
Pumping down, e. g. after rinse-stop		

Programme end

Open the door – Switch off your machine

As soon as the programme selector switch has been pushed in and the unlocking time of 1-2 minutes has elapsed, the loading door can be opened. Release any depressed buttons with release button C. Push in the programme selector switch. Your washing machine is switched off. Turn the temperature selector to the O position.

Take out the laundry.

Check that the drum is completely empty, otherwise fabrics may be damaged during the next wash (e.g. shrink) or discolour other laundry.

Special accessories

Buld-under kit E-Nr. 605 898 832

Necessary should you wish to remove the existing worktop and install a free-standing automatic washing machine under a continuous worktops.

The kit contains:

- Cover plate with 2 fan discs as contact protection when the worktop is removed

The automatic washing machine without a worktop should not be used until after installation and earthing of the cover plate as described.

- 2 sliding rails to assist insertion under worktops
- Foil protection strip for protection of the underside of worktops in the region of the control panel and detergent dispenser.

Maintenance and care

From time to time, you should clean the detergent dispenser thoroughly.

- To do this, slightly lift the dispenser and withdraw with a short sharp pull. Detach the syphon in the special conditioner compartment.

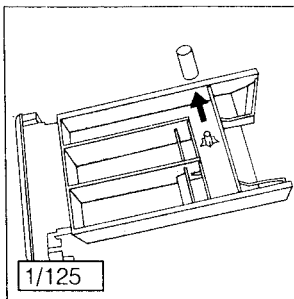

- Clean the dispenser compartments with warm water and a bottle brush.

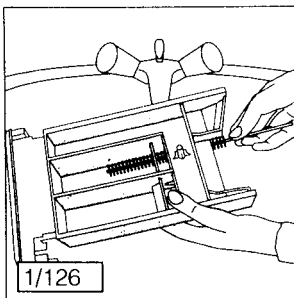

- Clean the syphon under running water. Re-insert the latter fully and check for proper fitting!
- Also clean the roof of the detergent compartments with a brush.
- Re-insert the dispenser in the guides and push it in.
- At the end of the programme, pull the washing powder compartment out a little way so that it dries.

The laundry drum is made of stainless steel. Any objects left in the laundry and likely to rust (see the section on "Preparing the laundry") may leave rust stains on the drum. These stains can be removed with a stainless steel cleaner.

Detergent dispenser

Laundry drum

Loading door

Remove any deposits or foreign bodies from the rubber sleeve behind the loading door.

The loading door should not be closed after washing, so that the drum can dry out and the machine is thoroughly ventilated.

Descaling

If you have ensured correct detergent dosage, your machine will scarcely ever need to be descaled. If descaling should be necessary, use only branded descaling agents with corrosion protection for washing machines. Your service centre stocks suitable agents.

Control panel

The control panel and controls should be cleaned with luke-warm water only. Do not use furniture polish or abrasive cleaning agents.

Frost protection

Frost damage does not come under your guarantee!

If your ÖKO-LAVAMAT is installed in room susceptible to frost, your machine must be subjected to emergency emptying as described in the section on "if you think your washing machine is not working properly..." if there is any imminent risk of frost.

Also unscrew the supply hose from the water tap and allow the water to run out. Place a cloth underneath!

If you think your washing machine is not working properly...

Minor faults you can rectify yourself

... the laundry loading door will not open immediately when the programme is interrupted?

- The door will open after 1-2 minutes (safety lock).
- A programme with rinser-hold has been selected.

... my washing machine is not working at all?

- Your machine may not be plugged in (the power plug may not be in the plug socket).
- The ON/OFF button is not selected.
- The loading door is not properly closed.
- Have you checked the fuses?

... no water enters?

- The water taps may not have been turned on.
- One of the filters in the water supply hoses is blocked.
One filter is located in the end of the hose connected to the water tap: unscrew the infill hose(s) and clean the filter under running water.
A second filter is located in the connection between hose and machine. Unscrew the infill hose(s) on the machine and clean the filter.

... there is a delay before the spin sequence starts?

- The electronic out of balance monitoring system of your machine has responded owing to poor laundry distribution.
Your laundry is loosened and distributed by the tumbling action of the drum and the spin sequence restarted. This may happen several times until the imbalance is corrected and the spin sequence can finally start.

... my washing machine vibrates?

- Very small wash loads (e.g. only one bathrobe) may cause your machine to vibrate. This does not affect operation of your machine in any way.
The appliance feet are not properly adjusted. See Instructions for Installation.

... the washing machine makes unusual noises?

- This washing machine possesses a modern drive system, which in comparison with earlier drives produces a different kind of noise, rather like a whistle.
The new drive allows the washing machine to build up speed gently when spin-drying, and to then keep to the speed-level set. The washing machine's stability has thereby been improved and its water-consumption lowered.

... the machine is oversudsing in the main wash?

- You have added too much detergent. Dose the detergent more accurately!
- Have you used a low lather detergent?

... my washing machine is noisy?

- The drain hose may be kinked, or
- The drain pump is blocked. In both cases, the water has not been pumped away efficiently or not at all.
See also "Cleaning the drain pump".
- There may still be transport packing in your washing machine, or your machine has not been properly installed and rocks from side to side.
See the installation instructions!

... water runs out from under the machine?

- The screw coupling on the supply hose or the hose clip on the drain hose may be loose.

Minor faults you can rectify yourself

- The drain hose is leaking.
- The cover of the drain pump in the plinth (fig. 1/32 E) is not properly secured after cleaning or emergency emptying. See "Cleaning the drain pump", in this section.
- ... **my laundry has not turned out as well as it usually does?**
- You have added too little detergent.
Underdosage leads to greying of your laundry and to scaling in your machine.
Ensure more accurate dosage!
- You may not have used the correct detergent.
- Special heavy soiling has not been pretreated.
- Have you correctly selected the programme and temperature?
- ... **the conditioning rinse was not dispensed and the conditioner compartment is filled with water?**
- The syphon in the compartment is not correctly inserted or is blocked. See "Maintenance and care".
- The washing powder compartment has been pulled out when it should have been dispensing.
- ... **despite pretreatment, stains are not removed during washing?**
- The stains may not be washable. Consult specialist (dry cleaners).
- ... **grey spots are found on the finished laundry (so-called greasy balls)?**
- Laundry soiled by ointments, fats, oils, or body grease, has been washed in too little detergent, therefore the amount of detergent has been insufficient to dissolve the grease. Add more detergent.
- Your laundry has been washed at too low a temperature.
- ... **even after the final rinse (rinse-hold), foam is still visible?**
- Modern detergents cause frothing even in the final rinse water, however, this is not a negative reflection on the rinsing result.
- ... **conditioner flecks remain on the finished laundry?**
- This is in most cases likely to be due to the fact that conditioning rinse – especially that in concentrated form – has directly affected your laundry.
Wash out these flecks as quickly as possible, and take care when handling these agents!
- ... **white detergent residues remain on my laundry after the programme has ended?**
- These residues are insoluble constituents of modern, phosphate-free detergents. They are not due to insufficient rinsing.
Possible remedies: Brush or shake out, or wash laundry turned inside out. Check detergent selection.
- ... **no water can be seen in the port-hole?**
- Modern washing machines work very economically, with such small quantities of water that it is sometimes not visible through the port-hole. Nevertheless, the machine still washes and rinses perfectly.

...my laundry is insufficiently spun or water remains in the drum?

- Owing to a kinked hose, the pump is not pumping away sufficient water from your machine.
- The pump head of max. 1 m is exceeded. For such cases, the service centre stocks a retrofitting kit with a second pump.
- The drain pump is blocked.

Proceed as follows when cleaning the drain pump:

- **Unplug your washing machine or take out the fuse.**
- Drain the water from the machine as described under "Emergency emptying in the event of a power failure" in the next section.
- Unscrew the drain pump cover anticlockwise (see arrow) and remove together with the insert. Place a cloth underneath as residual water may still run out.

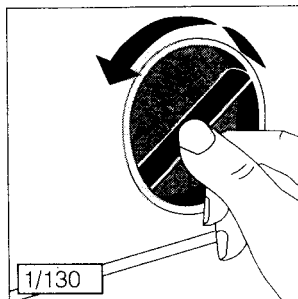

- Remove foreign bodies from the pump housing. Always also check by hand that the pump impeller runs freely.

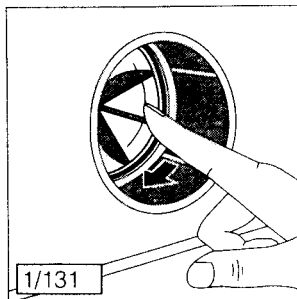

- Replace the cover and close by turning clockwise. Make sure it is closed tightly otherwise water will leak from the pump.
- Close emergency drain hose with plug. Push back into the machine. Secure the plug by rotating it a quarter turn clockwise.

**Minor faults
you can rectify
yourself**

... the washing machine no longer pumps water away and a high water level can be seen in the window?

- Proceed as follows:
 - Slightly ease out plug A from the plinth and turn clockwise (in direction of arrow) by a quarter turn until it stops.
 - Pull out hose B and remove plug A.

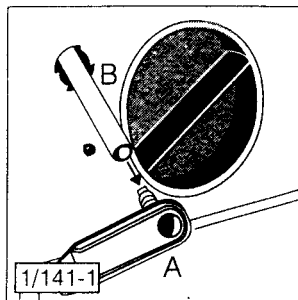

- Allow the residual water to drain into a bowl (place a cloth underneath). Depending on the amount of residual water, it may be necessary, to empty the collecting bowl several times.
Take care when the suds are hot! Where necessary, allow to cool first!
- Replace plug A into the emergency drain hose B.
- Push in emergency drain hose and secure A.

Please note:

After emergency emptying, your washing machine has been emptied completely.

To ensure the function of my ÖKO lock, it is necessary to add around 1/2 l water to my detergent dispenser.

If, you decide to call the service centre to help with any of the stated instructions or on grounds of faulty operation, the service engineer's visit cannot be made free of charge even during the guarantee period.

Customer service

If no reference is made to a particular fault in the Operating Instructions, please contact the service centre.

When doing so, quote the product number (E-No.) and serial number (F-No.) of your machine. You will find these numbers on the rating plate.

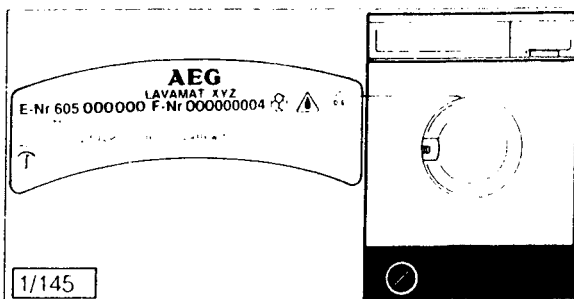

Providing these numbers enables the service centre to make precise identification of the required spare part so that your washing machine can be repaired on the engineer's first visit. You will thus save yourself additional costs due to repeated visits by the service engineer.

To keep these numbers handy, we recommend you to enter them here:

E-No.

F-No.

AEG Service in the United Kingdom

AEG Domestic Appliances Limited

Head Office:

217 Bath Road

Slough, Berks SL1 4AW

Tel: 01753 872506

Telefax: 01753 512271

AEG Northern Service Centre: AEG Scottish Service Centre:

Unit 20, Haigh Park

Haigh Avenue

Stockport

Gt. Manchester SK4 1QR

Tel: 0161 4872205

Telefax: 0161 4741191

Block 11, Unit 1

Dundyvan Industrial Estate

Coatbridge

Lanarkshire ML5 4AQ

Tel: 01236 440387

Telefax: 01236 440256

Service Appointments:

Bristol: 01179 252880

Norfolk: 01603 765515

Technical data

Dimensions:

With worktop

Height 85.0 cm

Width 60.0 cm

Depth 60.0 cm

Without worktop

Height 82.0 cm

Width 59.5 cm

Depth 57.0 cm

Connection

Information relating to electrical connection is given on the rating plate and in the separate installation instruction supplied with the machine.

Please ensure that the voltage and current indicated on the rating plate agrees with the voltage of your electricity supply. 220/240 volts – (i.e., 220/240 V AC).

Drum speeds:

Washing 50 min¹

Spinning max. 800 min⁻¹

Water pressure:

1-10 bar (= 10-100 N/cm² = 0.1-1.0 MPa) cold water supply

0.3-10 bar hot water supply

Weight empty:

Approx. 80 kg

 This appliance complies with the following EC Directives:

- 73/23 EEC of 19. 02. 1973 – Low-Voltage Directive
- 89/336 EEC of 03. 05. 1989 (including Amendment Directive 92/31 EEC) – EMV Directive.

AEG Domestic Appliances Ltd

Customer Care Department

55-77 High Street

Slough

Berkshire SL1 1DZ

Telephone: 08705 350350