Operating Instructions

Fully automatic
washing machine
LAVAMAT 804 TS

AEG

Please read these instructions carefully before using your LAVAMAT the first time. This will help you to avoid operating faults and will save you time and money.

Points to observe when unpacking, installing and connecting the machine can be found on pages 18—20.

This appliance complies with the requirements laid out in the EEC Directive 76/889.

	Page
Contents	2
Front view	3
Before using for the first time	4
What to do before each time you use the machine	4
The function of the knobs and buttons	5—7
Preparing the laundry	
— Sorting the laundry	8
— Tips on removing stains	9
— Load sizes	10
— Adding wash powder	11—12
Opening and closing the door	12
Wash programmes	13—14
What can be the cause if	15—16
Care and maintenance	17
Points to observe when installing and connecting	18—20
Electrical connection	21
If service is required	22

LAVAMAT 804 TS
E-Nr. 605 197 901
800 min⁻¹

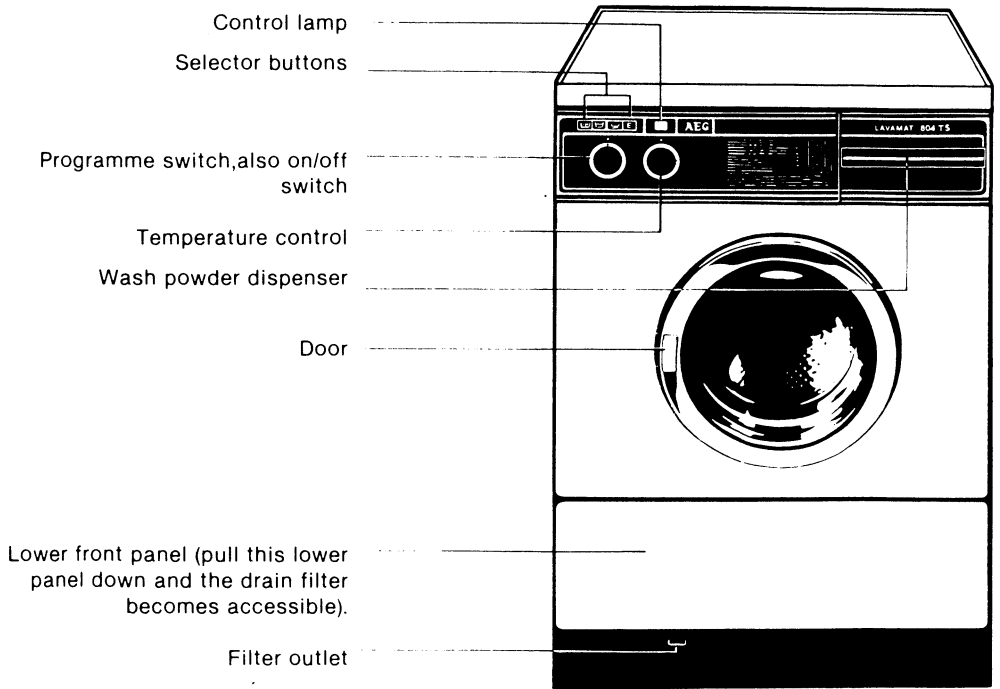

**You must
remove these
transit bars!**

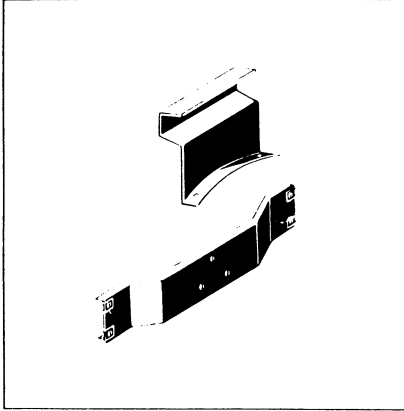

Transit bars

To avoid damage during transport we have fitted transit bars (see illustration above). Please remove these before installing and connecting the machine.

See instructions on the red label which is stuck to the appliance. Please keep these transit bars (you may move house).

**Protective
foil**

The foil which is attached to the switch panel and its surround to protect it against damage during transport

should be removed prior to using for the first time.

**Installing
and
Connecting**

The LAVAMAT is easy to install and connect. You must, however, follow the instructions given on pages 18—20 and make sure that

you comply with the regulations of your local Water Board and Electricity Board. In case of doubt, please consult a specialist.

What to do before each time you use the machine

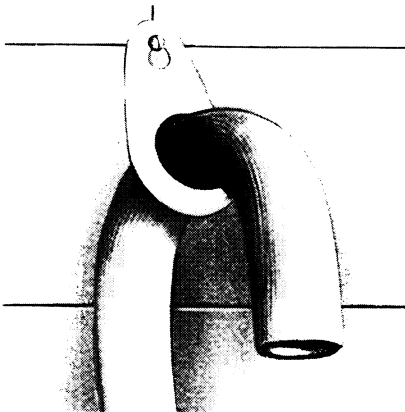

1. Plug the machine in.
2. Make sure that the drain hose is not kinked. The end of this hose is bent, so that it can be hooked over the edge of a sink or wash basin. However, make sure that it cannot slip off.
3. Connect the supply hose to the tap.
4. Open the tap.

The function of the knobs and buttons

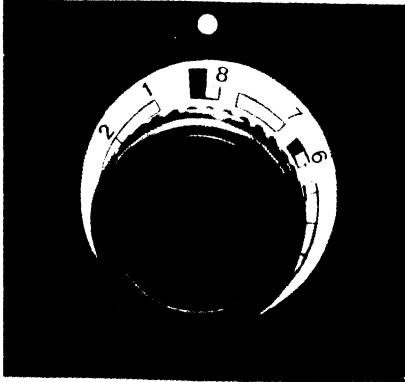

'0' position

Programme Switch

Besides the '0' position (see illustration) the programme switch has 8 settings for the basic programmes and the additional programmes. These are:

- 1 Wash programme with pre-wash
- 2 Wash programme without pre-wash
- 3 Soft rinsing — mild starching — spinning
- 4 Pumping — spinning
- 5 Woollens
- 6 Pumping — VARIOMATIC spinning
- 7 Soaking — extra pre-wash
- 8 Pumping

With the exception of woollens you can wash all fabrics with or without

spinning.

The programme switch must always be operated when the machine is switched off and in a clockwise direction, to allow the switch to 'click' into the selected setting.

The programme selector knob serves also to switch your LAVAMAT on and off.

To switch on = pull

To switch off = push

The programme only starts when you pull out the programme selector knob. This knob then begins to rotate. It stops only during the heating up period until the required temperature is reached.

Temperature control

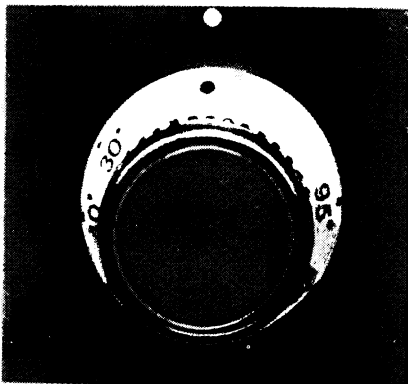

With the temperature control knob you can adjust the temperature to any level between 30° and 95° C. In the position marked by the brown dot ● the machine carries out a cold wash (e.g. for wool).

Please follow the manufacturer's washing instructions and pay attention to the international symbols on the laundry care labels.

The function of the knobs and buttons

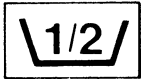
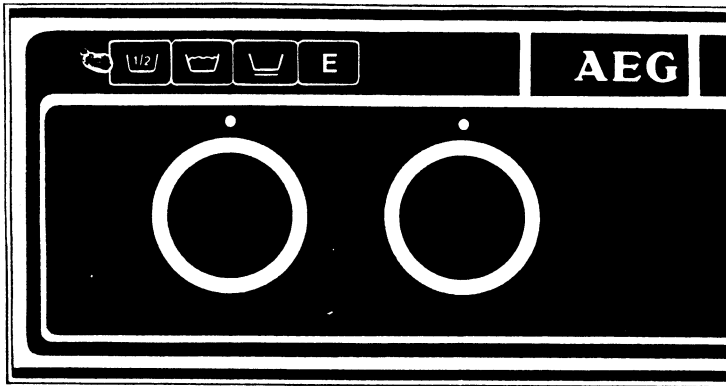



Economy
button for
small loads

Press this button if you wish to wash a smaller load, i.e. the drum is not full.

Application: About half a drum full (up to 2.5 kg dry weight of whites and coloureds and up to 0.8 kg of easy-care fabrics and delicates). Depending on the programme you save:

- ▯▯ Water. Your LAVAMAT washes and rinses with less water.
- ▯▯ Electricity. The heating up time is reduced, the required temperature is nevertheless reached.

- Washing powder: Approx. 30%.

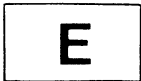

▯▯ Time. Thanks to the reduced heating up time the programme does not last so long. Basically, you should wash full loads whenever possible to achieve maximum economy in every respect. You can combine the 1/2 button with programmes 1, 2 and 3, and buttons  and  for easy-care fabrics and delicates.



Energy
saving
button

If you have only lightly to normally soiled cottons and linens (e.g. underwear, white or coloured bed linen which has only been used for a short time), you can use this button. This will help you to save up to 30 % electricity. The temperature is limited to 60°C and the water is heated up slowly.

The energy saving programme works as intensively and lasts almost as long as the programme for whites or colour-fast 95°C.

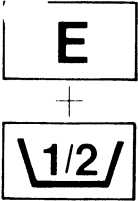

You can combine the E button with programmes 1 and 2 — but **not** with buttons  (delicates) and  easy-care.

The function of the knobs and buttons



Energy saving button and economy button for small loads

Pressing both buttons together makes sense if you wish to wash just a few items of lightly to normally soiled whites and coloureds. This will save water, even more electricity and up to 30 % washing powder.

Both buttons can be combined with programmes 1 and 2 — but **not** with buttons  (delicates) and  easy-care.



Button for delicates

Press this button if you wish to wash curtains or minimum iron fabrics made of synthetic fibres (nylon, polyester) or of acrylic, as well as sensitive articles made of silk or artificial silk.

The laundry is washed at a high water level.

Button  can be combined with programmes 1, 2 and 3. The laundry is left floating in the last rinse water. (To avoid creasing).

For "pumping and spinning" select programme 4.



Button for easy-care

Press this button if you wish to wash baby clothes and minimum iron articles made of cotton or cotton mixtures and synthetics.

The laundry is washed at normal water level.

The easy-care button can be combined with programmes 1 and 2. The laundry is left floating in the last rinse water. (To avoid creasing).

For "pumping and spinning" select programme 4.

End of programme

Press the programme selector knob. The control light goes out.

Return both the programme switch and the temperature selector to the '0' position.

In case of programmes with 'rinse water stop', remember to pump

off the water before opening the door. Set the programme switch to 8 and pull out the programme selector knob. If you have nothing else to wash, close the tap. Press the programme selector knob once again and remove the plug from the socket.

Sort your laundry according to the international care symbols

Sorting the laundry

It pays for you to pay special attention to the manufacturer's instructions or to the laundry care labels inside each garment. This is how you should sort your laundry:

Cottons and linens

Practical tips

Coloured and white cottons and linens do not belong together. Whites become grey if they are washed with coloureds.

New items tend to lose some of their colour when washed for the first time. It is therefore better to wash them separately for the first time.

Woollen items which carry the wool sign must also bear the description "machine washable". Woollen items which only bear the wool sign cannot be washed in washing machines.

Make sure that no metal items (e.g. paperclips, safety pins, pins) are

Coloureds Easy-care Delicates Woollens

For more details see page 10 and following pages.

left in the laundry. Fasten buttons etc. on duvet covers, do up zips, hooks and eyes, tie loose belts, long apron strings etc.

Remove stubborn stains prior to washing (see also next pages).

Synthetic curtains have to be handled particularly carefully. They can be damaged (so-called "pulls") if a window is left open or when they are taken down. Remove hooks and, if applicable, rollers or tie them up in a net or in a pillow case.

Once more: be very careful with your curtains as we accept no responsibility for any damage which may occur to them.

The International Textile Care Labelling Code

Symbol	Fabric
	White cotton and linen articles without special finishes
	Cotton, linen or rayon articles without special finishes where colours are fast at 60°C
	White nylon; white polyester/cotton mixtures
	Coloured nylon; polyester; cotton and rayon articles with special finishes; acrylic/cotton mixtures; coloured polyester/cotton
	Cotton, linen or rayon articles colours are fast at 40°C but not at 60°C
	Acrylics; acetate and triacetate, including mixtures with wool; polyester/wool blends
	Wool, including blankets and wool mixtures with cotton or rayon; silk
	Silk and printed acetate fabrics with colours not fast at 40°C
	Cotton articles with special finishes capable of being boiled but requiring drip-drying
	Do not machine wash
	Do not wash

Ironing

This symbol is used to provide ironing instructions. The number of dots within the symbol is varied to indicate the correct temperature setting, as follows:—

- One dot = cool
- Two dots = warm
- Three dots = hot
- Crossed out = **do not iron**

Dry cleaning

A circle is the symbol used for dry-cleaning instructions. It will never appear on its own but will have additional information as follows:

- Articles normal for dry-cleaning in all solvents.
- Articles normal for dry-cleaning in perchlorethylene, white spirit, Solvent 113 and Solvent 11.
- Articles normal for dry-cleaning in white spirit or Solvent 113.
- Do **not** dry-clean.

If possible remove stains **immediately** with lukewarm water and soap. Stains which have been left are more difficult to remove. Use a clean, absorbent cloth. Do not rub, but dab the stain! Bleaching agents and many stain removers are particularly harsh — therefore try them out first where they will not be seen (on a seam, on the inside of the garment).

- Do not shake stain remover into the drum.
- Do not inhale solvents. They are injurious to health.
- Be careful with inflammable stain removers
- Keep stain removers out of the reach of children. (They may be poisonous.)

Blood stains Wash with soap and cold water

Ink, felt-tip and ball-point pen stains Treat with alcohol or bleach

Grease Remove with petrol or carbontetrachloride

Grass Treat with bleach.

Coffee, tea, cocoa, fruit and red wine Treat white or colour-fast cottons with chloride bleach. Faint stains come out when washed.

Ive Treat with acetone.

Make-up Remove the grease with liquid stain remover. Then treat stubborn stains with a 0.5—1 % solution of bleach.

Mould spots Mould spots come out in the wash. Treat remaining stubborn stains with diluted chloride bleach.

Tar Pre-treat with liquid stain remover, alcohol or petrol and then smear with soft soap.

How much laundry you can load into the drum



Type of laundry	Full load	Half load
Whites and coloureds lightly to normally soiled	up to 5 kg dry laundry	up to 2.5 kg dry laundry
Whites and coloureds heavily soiled	up to 3.5 kg dry laundry	up to 2.5 kg dry laundry
Easy-care and delicates	up to 1.5 kg dry laundry which equals approx. 6 to 8 shirts, or a curtain of approx. 2.5 x 5 m	up to 0.8 kg dry laundry
Woollens	up to 1 kg dry laundry	

Tip

If there is too little laundry in the drum (e.g. just one dressing gown), this may cause vibration noises and

unsteady movement.

We therefore recommend that you add more items.



Prior to
switching on

1. Open the tap.
2. Distribute the laundry in the drum as loosely and as evenly as possible. Mix small items with large items if possible.
3. Close the door.
4. Pull out the soap drawer and add washing powder to compartment A and B and conditioner to compartment C. Push the soap drawer back in. It must click into place, as otherwise no water can enter the machine.
5. Set the required programme. Details about this are given on the following pages.
6. Pull the programme selector knob. The programme starts and the red control light comes on.

- We recommend the use of Persil automatic which has been specially formulated for front loading automatics. For easy-care fabrics, delicates and wool we recommend that you use soap powders which have been specially designed for them.
- You should only use liquid fabric conditioner or starch. If, however, you wish to use powder starch, then dissolve it according to the manufacturer's instructions and shake the dissolved starch **straight into the drum** after the main programme has ended.
- How much wash powder you need to use depends on the water hardness (soft, medium, hard, very hard) and on the amount of laundry.
- Your Local Water Authority will tell you how hard the water in your area is. On your wash powder packet you will find exact instructions as to how much soap powder to use (according to water hardness).

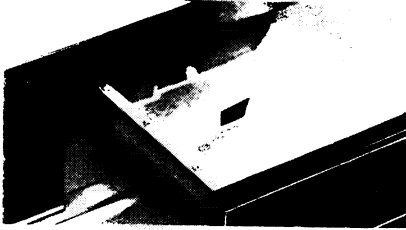

Practical tips

If a measuring beaker is supplied with the soap powder, fill it only as far as the marking and not to the rim. Otherwise the soap powder may foam up and foaming means reduced cleaning power. It is therefore better to use less soap powder from the beginning if the laundry

is only lightly soiled. Or you omit the pre-wash.

- ▮ If you wash only a small quantity of laundry (programmes with the $\sqrt{12}$ load button depressed), then use approximately $\frac{1}{3}$ less soap powder than given on the soap powder packet.

Opening and closing the door



Important





Open the door and close again after loading the drum with laundry. Only if the door is properly closed can the programme start.







The door incorporates a safety interlock which prevents it being opened during a programme. If the programme ends with a spin cycle you cannot open the door within 1 minute after the programme has finished — this is a safety feature!

To open the door it is necessary to return the programme switch to the '0' position (see illustration on top of page 5).

Before opening the door check the water level in the drum.

Should rinse or soak water be left in it, you must pump it away prior to opening the door. To do this turn the programme switch to 8 and pull it out.

Main programmes	Type of laundry	Load size	Wash powder dispenser	Programme selector	Programme setting Buttons	Temp. control	Programme cycle
Cottons and linens with prewash	cotton, linen, e.g. bed linen, table linen, underwear, shirts, towels, tea cloths, aprons etc. 1  2  5 	5 kg max.	A B C	1	30° to 95° C	Prewash — main wash at normal water level — cooling — 3 rinses — spinning	
Cottons and linens without prewash		5 kg max.	B C	2	30° to 95° C	Main wash at normal water level — cooling — 3 rinses — spinning	
Whites with prewash	cotton, linen etc. lightly soiled 1 	5 kg max.	A B C	1	95° C	Prewash — main wash at normal water level — cooling — 3 rinses — spinning	
Whites without prewash		5 kg max.	B C	2	95° C	Main wash at normal water level — cooling — 3 rinses — spinning	
Easy-care with prewash	special finish cotton, cotton mixtures, synthetics which do not require a high water level	1,5 kg max.	A B C	1	30° to 95° C	Prewash — main wash at normal water level — cooling — rinses — the laundry is left in the last rinse water	
Easy-care without prewash		1,5 kg max.	B C	2	30° to 95° C	Main wash at normal water level — cooling — 3 rinses — the laundry is left in the last rinse water	
Easy-care with prewash	nylon, polyester, cotton mixtures, cotton with special finishes; all outer garments which require a high water level	1,5 kg max.	A B C	1	30° to 40° C	Prewash — main wash at high water level — cooling — 3 rinses — the laundry is left floating in the last rinse water	
Easy-care without prewash		1,5 kg max.	B C	2	30° to 40° C	Main wash at high water level — cooling — 3 rinses — the laundry is left floating in the last rinse water	

Main programmes	Type of laundry	Load size	Wash powder dispenser	Programme selector	Programme setting Buttons	Temp. control	Programme cycle
Machine washable woollens 	Fabrics of machine-washable wool or wool mixtures 7 	1,0 kg max.	B C	5	to 40 °C	Main wash at high water level and particularly gentle drum movement — 3 rinses — the laundry is left floating in the last rinse water	
Silk, printed fabrics 	Fabrics of silk and printed acetate 8 30°C	1,0 kg max.	B C	5	to 30 °C	Main wash at high water level and particularly gentle drum movement — 3 rinses — the laundry is left floating in the last rinse water	
Additional programmes							
Soft rinsing, mild starching 	cotton, linen	5 kg max.	C	3		Rinsing and spinning	
Soft rinsing, mild starching 	easy-care fabrics, synthetics	1,5 kg max.	C	3		Rinsing — the laundry is left floating in the last rinse water	
Soaking — (extra) prewash 	cotton, linen, very heavily soiled	4,0 kg max.	A	7	up to 40 °C	Prewash at high water level — the laundry is left floating in the soap water	
Pumping, spinning	cotton, linen	5 kg max.		4		Spinning	
Pumping, VARIOMATIC spinning	easy-care fabrics, woollens, wool mixtures	1,0 kg max.		6		Gentle spinning — (repeated short spins followed by loosening action)	
Pumping	easy-care fabrics which must not be spun			8		Pumping	

 = RINSE WATER STOP! Fir
 Press  button for sn.
 Jump off the water (Programmes 6 or 8) before the door opened.
 Loads on programmes 1, 2 and 3.



What can be the cause ...

Non-functioning of your machine is mostly due to minor causes which you can rectify yourself.

Please also refer to the fault-finding chart on the inner side of the lower drop down panel which contains the same symbols as these pages.

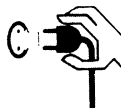

The programme does not start?

- Is the machine plugged in?
- Is the fuse alright?

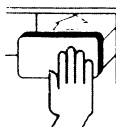

- Is the soap powder drawer pushed right in?

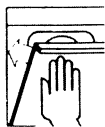

- Have the doors been shut properly (there are two doors on special models)?

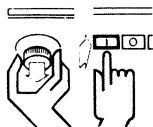

- Have you pulled out the programme selector knob to switch the machine on?



- Have you turned on the water tap?
- Is the filter in the water inlet hose blocked?

The filter is in the hose coupling to the water valve. Unscrew the hose and clean the filter under running water.



The water is not drained off completely.

- The drain hose may be kinked or twisted. The drainage pump is then not able to discharge the water from the machine completely.

- Check the drain filter (it may be blocked).



Incoming water is immediately running off again through the drainage hose

- The drainage hose is not hooked properly in place. The end of the hose which is bent must under no circumstances be dropped into the

drained off water or soak water, otherwise the incoming water will be drained off by suction.

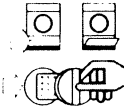

The machine does not spin

- The drain filter may be blocked.
- The motor has overheated.

A temperature cut-out incorporated in the motor has caused the motor to switch off in time.

Please await for approx. one hour. Only then has the motor cooled down and you can re-select programme 4 (pumping, spinning).

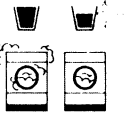

The soap powder foams over

- You have added too much soap powder. Use less powder for your next wash or omit the pre-wash.

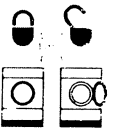

You cannot open the door when the programme has ended.

- After spinning you must wait until the release time of the door interlock has elapsed (approx. 1 minute). Should you have turned the programme switch to the '0' position

already, wait until the interlock is released and turn programme switch completely round once more to the '0' position in a clockwise direction.

The machine vibrates or is unsteady

- If there is too little laundry in the drum (e.g. just one dressing gown), this may lead to vibration. Therefore add more items. However, unsteady movement may also result from:

- Blocked drain filter.
- Kinked or squashed outlet hose.
- The transit bars have not been removed, or at least not all of them.
- The LAVAMAT does not stand on a firm base

There are rust spots in the drum

- The stainless steel drum cannot rust. What may look like rust stains are due to ferrous, foreign bodies (e.g. needles, paper-clips or the like) introduced with the laundry or

water. Remove such stains with a stainless steel cleaning agent. Do not use ferrous or chlorous scouring powders.

Please use this fault-finding chart as a check list for all provisions which guarantee the proper performance of your machine. If you call a service engineer in connection with one of the aforementioned problems you should be aware, that the cost involved in

this call will have to be passed on even during the warranty period. Should you be unable to locate the cause of the problem inspite of this check list, then please contact your AEG Service Department.

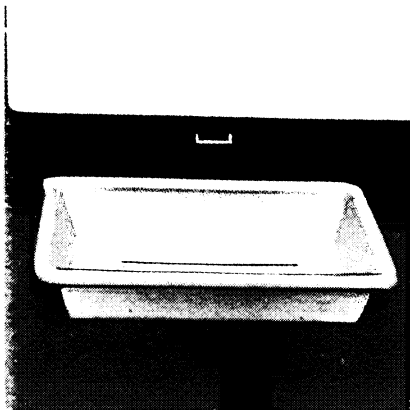

Drain filter

The drain filter collects fluff and foreign bodies which may get put into the drum with the laundry. You must, therefore, clean the drain filter regularly. To do this, place a flat dish below the filter outlet bottom left (see illustration). Pull down the lower front panel (if you have a built-under LAVAMAT use the plastic hooks which are

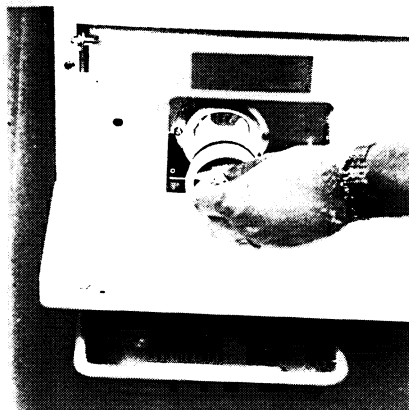

supplied to do so). Give the filter cover about half a turn in an anticlockwise direction (see illustration) so that any remaining water can drain off. Unscrew the filter completely and clean it. When refitting the filter, please ensure that it is inserted correctly and securely tightened.

Soap powder drawer

Leave the doors and the soap powder drawer open for a short while to allow the machine to dry out. Wash out any soap powder left in the drawer under running water. To do so,

hold the dispenser with both hands and give it a short, sharp pull to remove it completely. Replacing the soap powder drawer: insert into guide rails and push in.

Protection against frost

If there is a danger of frost, empty the machine in good time of all water by opening the drain filter.

Unscrew the supply hose and let it drain as well.

Points to observe when installing and connecting

If you wish to install the LAVAMAT yourself, you should read this section very carefully.

If your LAVAMAT is to be installed by a specialist, he will find here all the information he needs to ensure your

machine will function perfectly. Before installing the LAVAMAT, please remove the transit bars. You will find detailed instructions on how to do this on the red label stuck to the appliance.

Installation

Dimensions

with worktop:	without worktop:
Height 85 cm	Height 82 cm
Width 60 cm	Width 59.5 cm
Depth 60 cm	Depth 57.5 cm

Weight approx. 100 kg

Your machine features a 3 point support system, so that no adjustment should be necessary. It must stand on a firm base so that if load is applied to a corner, the appliance will not tilt. If necessary use a spirit level.

The floor where you wish to install the LAVAMAT should be clean and free from floor polish and grease.

The machine must not be installed on long pile carpets or carpets with a foam rubber underlay.

If you wish to mount the appliance on a plinth, it is of utmost importance that you fit steel plates to the plinth (available from our Service Dept. under the part no. 645 423 170).

To make it easier to move the machine into the recess between adjacent furniture units or appliances, special

runners are available from your AEG dealer under the accessory no. E 605 899 825.

Glue the runners firmly to the floor in the space you wish to install the LAVAMAT. Should the machine be built under a common worktop in a built-in kitchen, it is necessary to remove the table top of the machine. To comply with the Safety Regulations, the machine must be installed in such a way that there is no access to live parts or internal connections with functional insulation. Furthermore, the foam rubber strips on the underside of the table top of the machine must be removed and positioned instead on top of the 2 side panels of the machine. Should you discover some residual water in your machine, please do not worry. It does not mean that the machine has been used before, but is due to the very thorough quality control at our works. Any residual water will be pumped off automatically the first time the machine is used.

Water supply

Your washing machine is fitted with a high quality high pressure hose ($\frac{3}{8}$ in bore) with a $\frac{3}{4}$ " B.S.P. screw connector for connection to a water valve with male thread. The necessary washers are enclosed. (Please do not use any other washers as these may be of unsatisfactory quality). Hand tightening of the connector nut is sufficient — be very careful when using tools.

To protect the drinking water supply system, your washing machine is fitted with an anti-siphon and emergency overflow.

Please do not connect the machine to a hot water supply, as this has an adverse effect on the washing performance of the machine.

Points to observe when installing and connecting

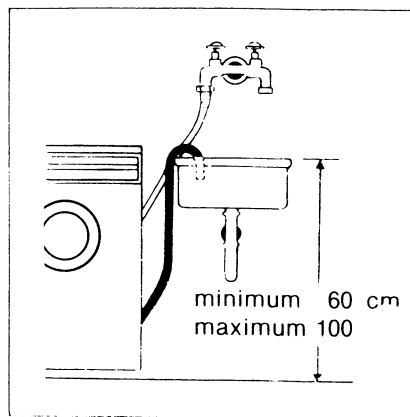
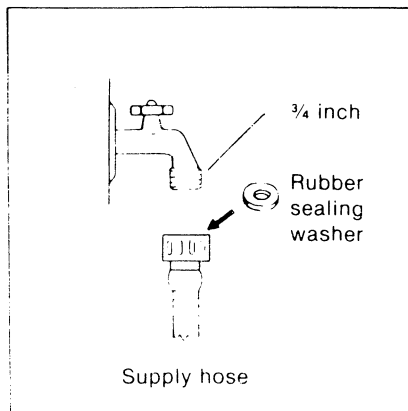

Water pressures
(for cold water supply only)

Minimum water pressure:
about 1 bar excess pressure
(= 1 atu. = 1 kgf/cm², = 10 N/cm²).
Maximum permissible water pressure:
about 10 bar. Where the supply
pressure exceeds 10 bar, it is

Notes for the plumber

Please ensure you comply with the drinking water regulations of your local Water Board.
Should you require longer supply hoses than provided, then please use only continuous high-pressure hoses (at least 60 bar) of suitable length.
DO NOT EXTEND THE EXISTING

Water discharge

To drain the machine of all soap and rinse water it is fitted with a pump which is controlled by the programme. It delivers water to a height of 1.1 m through the drain hose fitted at the back of the machine.

The drain hose (I/D 19 mm max.) is bent at the end for hooking it over a sink edge or similar. Please secure the bent end in such a way that it cannot slip off (especially where the sink or basin edge is very wide). To do this, you can use the holder provided and which can be attached to a wall hook or the tap (see illustration).

If a permanent connection to a siphon is required, you can shorten the drain hose as necessary. (In this case the hose must be ventilated. The neces-

sary to fit a pressure relief valve (type AD 723 E No. 612 896 723). If the flow rate is between 0.5 and 1 bar, the flow restrictor can be removed from the inlet valve.

HOSES. On no account must you use cheap garden hoses or similar. Please ensure that suitable clamps are used for attaching the hose to the connector fittings.
Please close the water tap on completion of each wash programme.

sary ventilating valve or breather is available from your AEG Service Department).

When installing the machine in a room with floor drainage (guileys in laundry rooms), you can place the hose straight on the floor after cutting off the bent part at an angle. The hose has been routed inside the machine in such a way that no water can drain off unintentionally when placing the drain hose on the floor.

In the case of an emergency (e.g. a long power failure) open cover of drain filter carefully and let the water drain off into a flat dish on the floor. You can then remove the laundry from the drum in the usual way.

Electrical connection

Connected load

GB version	240 V 50 Hz
3.03 kW	13 A
Standard version	220 V 50 Hz
3.08 kW	16 A
may be switched over to	
2.13 kW	10 A

WARNING! This appliance must be earthed.

Please note!

The plug moulded on the cord incorporates a fuse. For replacement, use a 13 amp BS 1362 fuse. Only ASTA approved or certified fuses should be used. The fuse cover/carrier must be replaced in the event of changing the fuse. The plug must not be used if the fuse cover/carrier is lost. A replacement cover/carrier must be obtained from authorised electrical goods retailers. If the socket outlets in your home are not suitable for the plug fitted to the appliance, then the plug must be cut off and an appropriate one fitted. When fitting the plug please note the following points:

IMPORTANT

THE WIRES IN THE MAINS LEAD ARE COLOURED IN ACCORDANCE WITH THE FOLLOWING CODE: —

GREEN AND YELLOW — EARTH
 BLUE — NEUTRAL
 BROWN — LIVE

As the colours of the wires in the mains lead of this appliance may not correspond with the coloured markings identifying the terminals in your plug proceed as follows:

1. The wire which is coloured GREEN and YELLOW must be connected to the EARTH terminal in your plug, which is marked with the letter E or by the earth symbol \perp or coloured GREEN, or GREEN and YELLOW.
2. The wire which is coloured BROWN must be connected to the LIVE terminal which is marked with the letter L or coloured RED.
3. The wire which is coloured BLUE must be connected to the NEUTRAL terminal which is marked with the letter N or coloured BLACK.

When wiring the plug, ensure that all strands of wire are securely retained in each terminal. Do not forget to tighten the mains lead clamp on the plug.

If service is required

Rating
plate

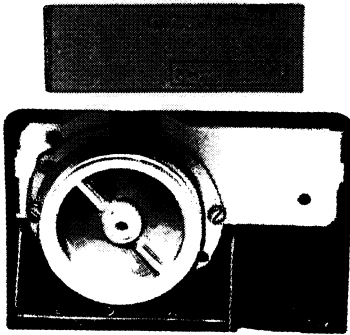

Model No.

E-Nr. 605 197 901

F No. (Serial No.)

When calling for a service engineer please quote the model no. and the serial no. of your machine. These nos. are imprinted on the rating plate which you will find

behind the cover flap for the drain filter. Complete the model no. with the last two digits and fill in the serial no. above, for your future reference.

