

# MC1751E / MC1761E

Microwave oven

Operating instructions



PERFEKT IN FORM UND FUNKTION

**AEG**  
Electrolux

# Dear Customer,

Thank you for buying an AEG-Electrolux microwave oven and putting your trust in the AEG-Electrolux brand name.

Before using your AEG-Electrolux microwave oven for the first time, please read the instruction book thoroughly. This will enable you to take advantage of all the features that the appliance offers. It will also ensure trouble-free operation and minimize unnecessary service calls.



Important information concerning your safety or the operation of your appliance is noted by this symbol and/or mentions words such as «**Warning**», «**Take care**». Be sure to follow all instructions carefully.



Throughout the manual, this symbol guides you step by step when operating the appliance.



This symbol indicates further information concerning the use of the appliance.



The clover indicates energy-saving tips and hints for environmentally friendly use of your appliance.

In the event of malfunctioning, please follow the instructions given in the section «What to do if...»

# Contents

Important safety instructions .....	2 - 3
Oven & accessories .....	4
Control panel .....	5
Before operation .....	6
Setting the clock .....	6
What are microwaves? .....	7
Suitable ovenware .....	7
Tips & advice .....	8 - 10
Microwave power levels .....	11
Manual operation .....	11
Other convenient functions .....	12 - 13
Automatic operation .....	14
Automatic charts .....	15 - 16
Recipes for automatic AC-6 & AC-7 .....	17
Cooking charts .....	18 - 19
Recipes .....	19 - 22
Care & cleaning .....	23
What to do if... ..	23
Service & spare parts .....	24
Customer care .....	24
Guarantee conditions .....	25
Specifications .....	26
Important information .....	26
Installation .....	27 - 28



The symbol  on the product or on its packaging indicates that this product may not be treated as household waste. Instead it shall be handed over to the applicable collection point for the recycling of electrical and electronic equipment. By ensuring this product is disposed of correctly, you will help prevent potential negative consequences for the environment and human health, which could otherwise be caused by inappropriate waste handling of this product. For more detailed information about recycling of this product, please contact your local city office, your household waste disposal service or the shop where you purchased the product.



# Important safety instructions

## IMPORTANT SAFETY INSTRUCTIONS: READ CAREFULLY AND KEEP FOR FUTURE REFERENCE

### To avoid the danger of fire.

**The microwave oven should not be left unattended during operation. Power levels that are too high, or cooking times that are too long, may overheat foods resulting in a fire.**

The electrical outlet must be readily accessible so that the unit can be unplugged easily in an emergency.

Do not store or use the oven outdoors.

**If food being heated begins to smoke, DO NOT OPEN THE DOOR. Turn off and unplug the oven and wait until the food has stopped smoking. Opening the door while food is smoking may cause a fire.**

**Only use microwave-safe containers and utensils. See Page 7.**

**Do not leave the oven unattended when using disposable plastic, paper or other combustible food containers.**

**Clean the waveguide cover, the oven cavity, the turntable and turntable support after use. These must be dry and free from grease. Built-up grease may overheat and begin to smoke or catch fire.**

Do not place flammable materials near the oven or ventilation openings. Do not block the ventilation openings.

Remove all metallic seals, wire twists, etc., from food and food packages. Arcing on metallic surfaces may cause a fire.

Do not use the microwave oven to heat oil for deep frying. The temperature cannot be controlled and the oil may catch fire.

To make popcorn, only use special microwave popcorn makers.

Do not store food or any other items inside the oven.

Check the settings after you start the oven to ensure the oven is operating as desired.

See the corresponding hints in the operation manual.

### To avoid the possibility of injury

#### **WARNING:**

Do not operate the oven if it is damaged or malfunctioning. Check the following before use:

- The door; make sure the door closes properly and ensure it is not misaligned or warped.
- The hinges and safety door latches; check to make sure they are not broken or loose.
- The door seals and sealing surfaces; ensure that they have not been damaged.
- Inside the oven cavity or on the door; make sure there are no dents.
- The power supply cord and plug; ensure that they are not damaged.

**Never adjust, repair or modify the oven yourself. It is hazardous for anyone other than a competent person to carry out any service or repair operation which involves the removal of a cover which gives protection against exposure to microwave energy.**

Do not operate the oven with the door open or alter the door safety latches in any way.

Do not operate the oven if there is an object between the door seals and sealing surfaces.

**Do not allow grease or dirt to build up on the door seals and adjacent parts. Follow instructions for "Care & Cleaning", Page 23. Failure to maintain the oven in a clean condition could lead to a deterioration of the surface that could adversely affect the life of the appliance and possibly result in a hazardous situation.**

Individuals with PACEMAKERS should check with their doctor or the manufacturer of the pacemaker for precautions regarding microwave ovens.

#### **To avoid the possibility of electric shock**

Under no circumstances should you remove the outer cabinet.

Never spill or insert any objects into the door lock openings or ventilation openings. In the event of a spill, turn off and unplug the oven immediately and call your local Service Force Centre.

Do not immerse the power supply cord or plug in water or any other liquid.

Do not allow the power supply cord to run over any hot or sharp surfaces, such as the hot air vent area at the top rear of the oven.

Do not attempt to replace the oven lamp yourself or allow anyone who is not authorised by Service Force to do so. If the oven lamp fails, please consult your dealer or contact your local Service Force Centre.

If the power supply cord of this appliance is damaged, it must be replaced with a special cord. The exchange must be made by an authorised Service Force technician.



# Important safety instructions

To avoid the possibility of explosion and sudden boiling:

**WARNING: Liquids and other foods must not be heated in sealed containers since they are liable to explode.**

Never use sealed containers. Remove seals and lids before use. Sealed containers can explode due to a build up of pressure even after the oven has been turned off. Take care when microwaving liquids. Use a wide-mouthed container to allow bubbles to escape.

**Microwave heating of beverages can result in delayed eruptive boiling, therefore care has to be taken when handling the container.**

To prevent sudden eruption of boiling liquid and possible scalding:

1. Stir liquid prior to heating/reheating.
2. It is advisable to insert a glass rod or similar utensil into the liquid whilst reheating.
3. Let liquid stand for at least 20 seconds in the oven at the end of cooking time to prevent delayed eruptive boiling.

**Do not cook eggs in their shells, and whole hard boiled eggs should not be heated in microwave ovens since they may explode even after microwave cooking has ended. To cook or reheat eggs which have not been scrambled or mixed, pierce the yolks and the whites, or the eggs may explode. Shell and slice hard boiled eggs before reheating them in the microwave oven.**

Pierce the skin of such foods as potatoes, sausages and fruit before cooking, or they may explode.

**To avoid the possibility of burns**

Use pot holders or oven gloves when removing food from the oven to prevent burns.

Always open containers, popcorn makers, oven cooking bags, etc., away from the face and hands to avoid steam burns.

**To avoid burns, always test food temperature and stir before serving and pay special attention to the temperature of food and drink given to babies, children or the elderly.**

Temperature of the container is not a true indication of the temperature of the food or drink; always check the food temperature.

Always stand back from the oven door when opening it to avoid burns from escaping steam and heat.

Slice stuffed baked foods after heating to release steam and avoid burns.

Keep children away from the door to prevent them burning themselves.

To avoid misuse by children

**Warning: Only allow children to use the oven without supervision when adequate instructions have been given so that the child is able to use the oven in a safe way and understands the hazards of improper use.**

Do not lean or swing on the oven door. Do not play with the oven or use it as a toy.

Children should be taught all important safety instructions: use of pot holders, careful removal of food coverings; paying special attention to packaging (e.g. self-heating materials) designed to make food crisp, as they may be extra hot.

**Other warnings**

Never modify the oven in any way.

This oven is for home food preparation only and may only be used for cooking food. It is not suitable for commercial or laboratory use.

**To promote trouble-free use of your oven and avoid damage.**

Never operate the oven when it is empty.

When using a browning dish or self-heating material, always place a heat-resistant insulator such as a porcelain plate under it to prevent damage to the turntable and turntable support due to heat stress. The preheating time specified in the dishes instructions must not be exceeded.

Do not use metal utensils, which reflect microwaves and may cause electrical arcing. Do not put cans in the oven. Only use the turntable and the turntable support designed for this oven. Do not operate the oven without the turntable.

To prevent the turntable from breaking:

- (a) Before cleaning the turntable with water, leave the turntable to cool.
- (b) Do not put hot foods or hot utensils on a cold turntable.
- (c) Do not put cold foods or cold utensils on a hot turntable.

Do not place anything on the outer cabinet during operation.

**NOTE:**

If you are unsure how to connect your oven, please consult an authorised, qualified electrician.

Neither the manufacturer nor the dealer can accept any liability for damage to the oven or personal injury resulting from failure to observe the correct electrical connection procedure.

Water vapour or drops may occasionally form on the oven walls or around the door seals and sealing surfaces. This is a normal occurrence and is not an indication of microwave leakage or a malfunction.

# Oven & accessories

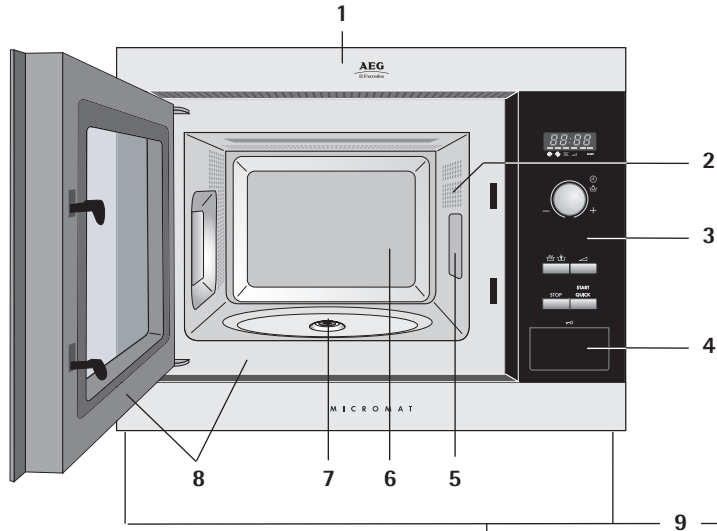

- 1 Front trim
- 2 Oven lamp
- 3 Control panel
- 4 Door opening button
- 5 Waveguide cover
- 6 Oven cavity
- 7 Seal packing
- 8 Door seals and sealing surfaces
- 9 Fixing points (4 points)

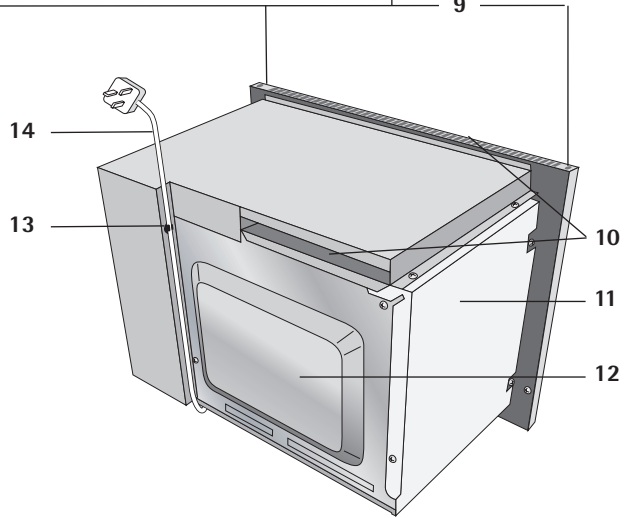

## ACCESSORIES:

Check to make sure the following accessories are provided:

- (15) Turntable (16) Turntable support
- (17) 4 fixing screws (not shown).

- Place the turntable support in the seal packing on the floor of the cavity.
- Then place the turntable on the turntable support.
- To avoid turntable damage, ensure dishes or containers are lifted clear of the turntable rim when removing them from the oven.

**NOTE:** When you order accessories, please mention two items: part name and model name to your dealer or local Service Force Centre.

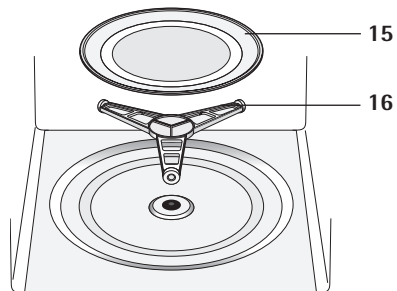

# Control panel

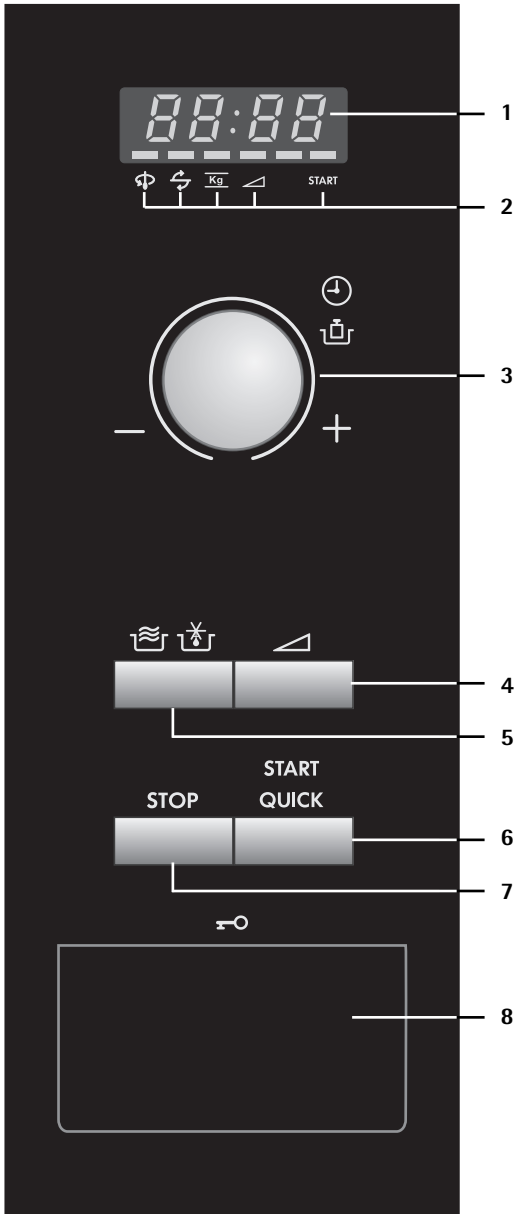

**1 Digital Display**

**2 Indicators**

The appropriate indicator will flash or light up, just above each symbol according to the instruction. When an indicator is flashing, press the appropriate button (having the same symbol) or carry out the necessary operation.

- ☞ Stir
- ↻ Turn over
- kg Weight
- △ Microwave power level
- START Cooking in progress

**3 TIMER/WEIGHT knob**

**4 MICROWAVE POWER LEVEL button**

**5 AUTOMATIC PROGRAMMES button**

Press to select one of the 12 automatic programmes.

**6 START/QUICK button**

**7 STOP button**

**8 DOOR OPEN button**

# Before operation

Plug in the oven.

1. The oven display will flash:



2. Touch the **STOP** button the display will show:

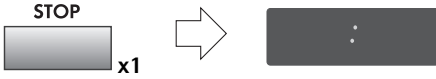

To set the clock, see below.

## Using the Stop button

Use the **STOP** button to:

1. Erase a mistake during programming.
2. Stop the oven temporarily during cooking.
3. Cancel a programme during cooking, touch twice.

# Setting the clock

There are two setting modes: 12 hour clock and 24 hour clock.

1. To set the 12 hour clock, hold the **MICROWAVE POWER LEVEL** button down for 3 seconds. **12 H** will appear in the display.
2. To set the 24 hour clock, press the **MICROWAVE POWER LEVEL** button once more after Step 1, in the example below **24 H** will appear in the display.



**x1** and hold for 3 secs.

To set the clock, follow the example below.

**Example:** To set the 24 hour clock to 23:35.

1. Choose the clock function. (12 hour clock)



**x1** and hold for 3 secs.

2. Choose the 24 hour clock.



**x1**

3. Set the hours. Rotate the **TIMER/WEIGHT** knob until the correct hour is displayed (23).

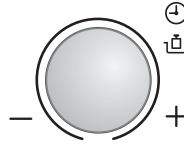

4. Press the **MICROWAVE POWER LEVEL** button to change from hours to minutes.



**x1**

5. Set the minutes. Rotate the **TIMER/WEIGHT** knob until the correct minute is displayed (35).

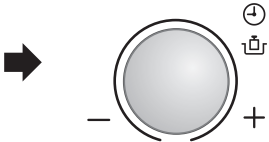

6. Press the **MICROWAVE POWER LEVEL** button to start the clock.

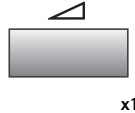

**x1**

Check the display.



### NOTE:

1. You can rotate the **TIMER/WEIGHT** knob clockwise or counter-clockwise.
2. Press the **STOP** button if you make a mistake during programming.
3. If the electrical power supply to your microwave oven is interrupted, the display will intermittently

show **88:88** after the power is reinstated. If this occurs during cooking, the programme will be erased. The time of day will also be erased.

4. When you want to reset the time of day, follow the above example again.



# **i** What are microwaves?

Microwaves are generated in the microwave oven by a magnetron and cause the water molecules in the food to oscillate. Heat is generated by the friction which is caused, with the result that the food is thawed, heated or cooked.

## **i** Suitable ovenware

### **Glass & ceramic glass**

Heat-resistant glass utensils are very suitable. The cooking process can be observed from all sides. They must not, however, contain any metal (e.g. lead crystal), nor have a metallic overlay (e.g. gold edge, cobalt blue finish).

### **Ceramics**

Generally very suitable. Ceramics must be glazed, since with unglazed ceramics moisture can get into the ceramic. Moisture causes the material to heat up and may make it shatter. If you are not certain whether your utensil is suitable for the microwave, carry out the utensil suitability test.

### **Porcelain**

Very suitable. Ensure that the porcelain does not have a gold or silver overlay and that it does not contain any metal.

### **Plastic & paper utensils**

Heat resistant plastic utensils which are suitable for use in the microwave can be used to thaw, heat and cook food. Follow the manufacturer's recommendations. Heat-resistant paper made for use in a microwave oven is also suitable. Follow the manufacturer's recommendations.

### **Kitchen paper**

Can be used to absorb any moisture which occurs in short heating methods, e.g. of bread or products in bread crumbs. Insert the paper between the food and the revolving plate. The surface of the food will stay crispy and dry. Covering greasy food with kitchen paper will catch splashes.

### **Microwave cling film**

This, or heat-resistant film, is very suitable for covering or wrapping. Please follow the manufacturer's recommendations.

### **Roasting bags**

Can be used in a microwave oven. Metal clips are not suitable for fastening them since the roasting bag foil might melt. Fasten the roasting bag with string and pierce it several times with a fork. Non heat-resistant food wraps are not recommended for use in a microwave oven.

### **Browning dish**

A special microwave dish made from ceramic glass with a metal alloy base, which allows food to be browned. When using the browning dish a suitable insulator, e.g. a porcelain plate, must be placed between the turntable and the browning dish. Be careful to adhere exactly to the pre-heating time given in the manufacturer's instructions. Excessive pre-heating can damage the turntable and the turntable stand or can trigger the safety-device which will switch off the oven.

### **Metal**

Generally speaking, metal should not be used, since microwaves do not pass through metal and therefore cannot reach the food. There are, however, exceptions: small strips of aluminium foil may be used to cover certain parts of the food, so that these do not thaw too quickly or begin to cook (e.g. chicken wings). Small metal skewers and aluminium containers (e.g. of ready-cooked meals) can be used. They must, however, be small in relation to the food, e.g. aluminium containers must be at least 2/3 to 3/4 filled with food. It is recommended that you transfer the food into a dish suitable for use in the microwave. When using aluminium containers or other metal utensils there must be a gap of approx. 2 cm between them and the walls of the cooking area, otherwise the walls could be damaged by possible arcing.

**No utensil should have a metal overlay** – parts such as screws, bands or handles.

### **Utensil suitability test**

If you are not sure whether your utensil is suitable for use in your microwave oven, carry out the following test: Place the utensil into the oven. Place a glass container filled with 150 ml of water on or next to the utensil. Switch on the oven at 800 W power for 1 to 2 minutes. If the utensil stays cool or just warm to the touch, it is suitable. Do not use this test on a plastic utensil. It could melt.

## **i** Tips & advice

### **Time settings**

In general the thawing, heating and cooking times are significantly shorter than when using a conventional cooker or oven. For this reason you should adhere to the recommended times given in this book. It is better to set the times too short, rather than too long. Test the food after it has been cooked. It is better to have to cook something for a little longer than to overcook it.

### **Initial temperatures**

Thawing, heating and cooking times are dependent upon the initial temperature of the food. Deep-frozen food and food stored in a refrigerator, for example, requires longer than food which has been stored at room temperature.

For heating and cooking, normal storage temperatures are assumed (refrigerator temperature approx. 5°C, room temperature approx. 20°C). For thawing the temperature of the deep freeze is assumed to be - 18°C.

### **Cooking times**

All the times given in this book are guidelines, which can be varied according to the initial temperature, weight and condition of the food (water or fat content etc.)

### **Salt, spices & herbs**

Food cooked in your microwave retains its individual flavour better than it does when conventional preparation methods are used. For this reason you should use salt very sparingly and normally add it only after cooking. Salt absorbs liquid and dries out the outer layer of the food. Herbs and spices can be used as normal.

### **Addition of water**

Vegetables and other foods with a high water content can be cooked in their own juice or with the addition of a little water. This ensures that many vitamins and minerals are preserved.

### **Food in skins or shells**

Food such as sausages, chickens, chicken legs, baked potatoes, tomatoes, apples, egg yolks or such like should be pricked or pierced with a fork or small wooden skewer. This will enable the steam which forms to dissipate without splitting the skin or shell.

### **Large & small quantities**

Microwave times are directly dependent upon the amount of food which you would like to thaw, heat or cook. This means that small portions cook more quickly than larger ones.

As a rule of thumb:

TWICE THE AMOUNT = ALMOST TWICE THE TIME

HALF THE AMOUNT = HALF THE TIME

### **Deep & shallow containers**

Both containers have the same capacity, but the cooking time is longer for the deeper one. You should therefore choose as flat a container as possible with a large surface area. Only use deep containers for dishes where there is a danger of overcooking, e.g. for noodles, rice, milk etc.

### **Round & oval containers**

Food cooks more evenly in round or oval containers than in containers with corners, since the microwave energy concentrates in the corners and the food in these areas could become overcooked.

### **Covering**

Covering the food retains the moisture within it and shortens the cooking time. Use a lid, microwave cling film or a cover. Foods which are to be crispy, e.g. roasts or chickens, should not be covered.

As a general rule, whatever would be covered in a conventional oven should also be covered in a microwave oven. Whatever would be uncovered in a conventional oven can also be left uncovered in a microwave oven.

### **Turning**

Medium-sized items, such as hamburgers and steaks, should be turned over once during cooking, in order to shorten the cooking process. Large items, such as roasts and chickens, must be turned, since the upper side receives more microwave energy and could dry out if not turned.

### **Standing time**

Keeping to the standing time is one of the most important rules with microwaves. Almost all foods, which are thawed, heated or cooked in the microwave, require a certain amount of time to stand, during which temperature equalisation takes place and the moisture in the food is evenly distributed.

## **i** Tips & advice

### **Browning agents**

After more than 15 minutes cooking time food acquires a brownness, although this is not comparable to the deep brownness and crispness obtained through conventional cooking. In order to obtain an appetising brown colour you can use browning agents. For the most part they simultaneously act as seasoning agents.

In the following table you will find some suggestions for substances you might use for browning and some of the uses to which you might put them.

<b>BROWNING AGENT</b>	<b>DISH</b>	<b>METHOD</b>
Melted butter and dried paprika	Poultry	Coat the poultry with the butter/paprika mixture
Dried paprika	Oven baked dishes"Cheese toasties"	Dust with paprika
Soya sauce	Meat and poultry	Coat with the sauce
Barbecue and Worcestershire sauce, Gravy	Roasts, Rissoles, Small roasted items	Coat with the sauce
Rendered down bacon fat or dried onions	Oven baked dishes, toasted items, soups, stews	Sprinkle pieces of bacon or dried onions on top
Cocoa, chocolate flakes, brown icing, honey and marmalade	Cakes and desserts	Sprinkle pieces on top of cakes and desserts or use to glaze

### **Heating**

- Ready-prepared meals in aluminium containers should be removed from the aluminium container and heated on a plate or in a dish.
- Remove the lids from firmly closed containers.
- Food should be covered with microwave cling film, a plate or cover (obtainable from stores), so that the surface does not dry out. Drinks need not be covered.
- When boiling liquids such as water, coffee, tea or milk, place a glass stirrer in the container.
- If possible, stir large quantities from time to time, to ensure that the temperature is evenly distributed.
- The times are for food at a room temperature of 20°C. The heating time for food stored in a refrigerator should be increased slightly.
- After heating allow the food to stand for 1-2 minutes, so that the temperature inside the food can be evenly distributed (standing time).
- The times given are guidelines, which can be varied according to the initial temperature, weight, water content, fat content or the result which you wish to achieve.

### **Defrosting**

Your microwave is ideal for defrosting. Defrosting times are usually considerably shorter than in traditional methods of defrosting.

Here are a few tips. Take the frozen item out of its packaging and place on a plate for defrosting.

### **Boxes & containers**

Boxes and containers suitable for microwaves are particularly good for defrosting and heating food, since they can withstand temperatures in a deep freeze (down to approx. -40°C) as well as being heat-resistant (up to approx. 220°C). You can therefore use the same container to defrost, heat and even cook the food, without having to transfer it.

### **Covering**

Cover thin parts with small strips of aluminium foil before defrosting. Defrosted or warm parts should likewise be covered with aluminium strips during defrosting. This stops the thin parts becoming too hot while thicker parts are still frozen.

### **Correct setting**

It is better to choose a setting which is too low rather than one which is too high. By so doing you will ensure that the food defrosts evenly.

If the microwave setting is too high, the surface of the food will already have begun to cook while the inside is still frozen.

## **i** Tips & advice

### **Turning/stirring**

Almost all foods have to be turned or stirred from time to time. As early as possible, separate parts which are stuck together and rearrange them.

### **Small amounts...**

defrost more quickly and evenly than larger ones. We recommend that you freeze portions which are as small as possible. By so doing you will be able to prepare whole menus quickly and easily.

### **Foods requiring careful handling**

Foods such as gateaux, cream, cheese and bread should only be partially defrosted and then left to defrost completely at room temperature. By so doing you will avoid the outer areas becoming too hot while the inside is still frozen.

### **Standing time**

This is particularly important after defrosting food, as the defrosting process continues during this period. In the defrosting table you will find the standing times for various foods. Thick, dense foods require a longer standing time than thinner foods or food of a porous nature. If the food has not defrosted sufficiently, you may continue defrosting it in the microwave oven or lengthen the standing time accordingly. At the end of the standing time you should process the food as soon as possible and not re-freeze it.

## **COOKING FRESH VEGETABLES**

- When buying vegetables try to ensure that, as far as possible, they are of similar size. This is particularly important when you want to cook the vegetables whole (e.g. boiled potatoes).
- Wash the vegetables before preparing them, clean them and only then weigh the required quantity for the recipe and chop them up.
- Season them as you would normally, but as a rule only add salt after cooking.
- Add about 5 tbsps of water for 500 g of vegetables. Vegetables which are high in fibre require a little more water. You will find information about this in the table.
- Vegetables are usually cooked in a dish with a lid. Those with a high moisture content, e.g. onions or boiled potatoes, can be cooked in microwave cling film without adding water.
- After half the cooking time has elapsed vegetables should be stirred or turned over.

- After cooking allow the vegetables to stand for approx. 2 minutes, so that the temperature disperses evenly (standing time).
- The cooking times given are guidelines and depend upon the weight, initial temperature and condition of the type of vegetable in question. The fresher the vegetables, the shorter the cooking times.

## **COOKING MEAT, FISH & POULTRY**

- When buying food items, try to ensure that, as far as possible, they are of similar size. This will ensure that they are cooked properly.
- Before preparation wash meat, fish and poultry thoroughly under cold running water and pat them dry with kitchen paper. Then continue as normal.
- Beef should be well hung and have little gristle.
- Even though the pieces may be of a similar size, cooking results may vary. This is due, amongst other things, to the kind of food, variations in the fat and moisture content as well as the temperature before cooking.
- After the food has been cooking for 15 minutes it acquires a natural brownness, which may be enhanced by the use of a browning agent. If, in addition, you would like the surface to be crisp you should either use the browning dish or sear the food on your cooker and finish cooking it in your microwave. By doing this you will simultaneously obtain a brown base for making a sauce.
- Turn large pieces of meat, fish or poultry half way through the cooking time, so that they are cooked evenly from all sides.
- After cooking cover roasts with aluminium foil and allow them to stand for approx. 10 minutes (standing time). During this period the roast carries on cooking and the liquid is evenly distributed, so that when it is carved a minimum amount of juice is lost.

## **DEFROSTING & COOKING**

Deep-frozen dishes can be defrosted and cooked at the same time in one process in your microwave. You will find some examples in the table (see page 18). Do take note, however, of the general advice given on "heating" and "defrosting" food. Please refer to the manufacturer's instructions on the packaging when preparing deep-frozen dishes. These usually contain precise cooking times and offer advice on preparation.

## Microwave power levels

Your oven has 5 power levels. To choose the power level for cooking, follow the advice given in the recipe section. Generally the following recommendations apply:

**800 W** used for fast cooking or reheating e.g. soup, casseroles, canned food, hot beverages, vegetables, fish, etc.

**560 W** used for longer cooking of dense foods such as roast joints, meat loaf and plated meals, also for sensitive dishes such as cheese sauce and sponge cakes. At this reduced setting, the sauce will not boil over and food will cook evenly without over cooking at the sides.

**400 W** for dense foods which require a long cooking time when cooked conventionally, eg. beef dishes, it is advisable to use this power setting to ensure the meat will be tender.

**240 W** to defrost, select this power setting, to ensure that the dish defrosts evenly. This setting is also ideal for simmering rice, pasta, dumplings and cooking egg custard.

**80 W** For gentle defrosting, eg. cream gateaux or pastry.

W = WATT

To set the power, touch the **MICROWAVE POWER LEVEL** button until the desired level is displayed. If **MICROWAVE POWER LEVEL** button is touched once, **800** will be displayed. If you miss your desired level, continue touching the **MICROWAVE POWER LEVEL** button until you reach the level again. **If the level is not selected, the level 800 W is automatically set.**

## Manual operation

Your oven can be programmed for up to 90 minutes. (90.00) The input unit of cooking (defrosting) time varies from 10 seconds to five minutes. It depends on the total length of the cooking (defrosting) time as shown on the table.

Cooking time	Increasing unit
0-5 minutes	10 seconds
5-10 minutes	30 seconds
10-30 minutes	1 minute
30-90 minutes	5 minutes

**Example:** Suppose you want to heat soup for 2 minutes and 30 seconds on 560 W microwave power.

1. Enter the desired cooking time by rotating the **TIMER/WEIGHT** knob clockwise. (2 min. and 30 sec.)
2. Choose desired power by pressing the **MICROWAVE POWER LEVEL** button twice.
3. Press the **START/QUICK** button to begin cooking.

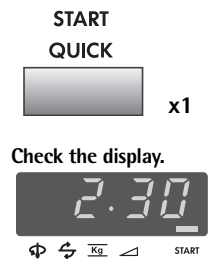
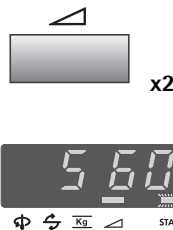

Check the display.

### NOTE:

1. When the door is opened during the cooking process, the cooking time on the digital display stops automatically. The cooking time starts to count down again when the door is closed and the **START/QUICK** button is pressed.
2. If you wish to know the power level during cooking, press the **MICROWAVE POWER LEVEL** button. As long as your finger is touching the **MICROWAVE POWER LEVEL** button, the power level will be displayed.
3. You can rotate the **TIMER/WEIGHT** knob clockwise or counterclockwise. If you rotate the knob counterclockwise, the cooking time will decrease from 90 minutes by degrees.

# Other convenient functions

## 1. MULTIPLE SEQUENCE COOKING

A maximum of 3 sequences can be input, consisting of manual cooking time and mode.

### Example:

To cook: 5 minutes on 800 W power (Stage 1)  
16 minutes on 240 W power (Stage 2)

### STAGE 1

1. Enter the desired cooking time by rotating **TIMER/WEIGHT** knob.
2. Choose the desired power level by pressing the **MICROWAVE POWER LEVEL** button once.

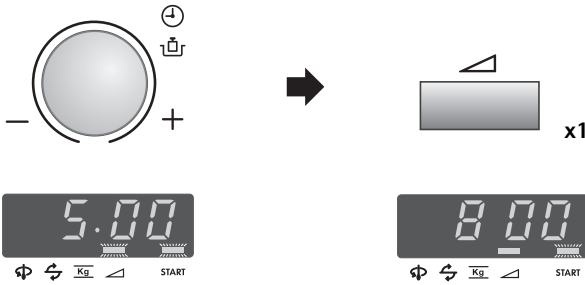

### STAGE 2

3. Enter desired time by rotating **TIMER/WEIGHT** knob.
4. Choose the desired power level by pressing the **MICROWAVE POWER LEVEL** button four times.
5. Press the **START/QUICK** button once to begin cooking.

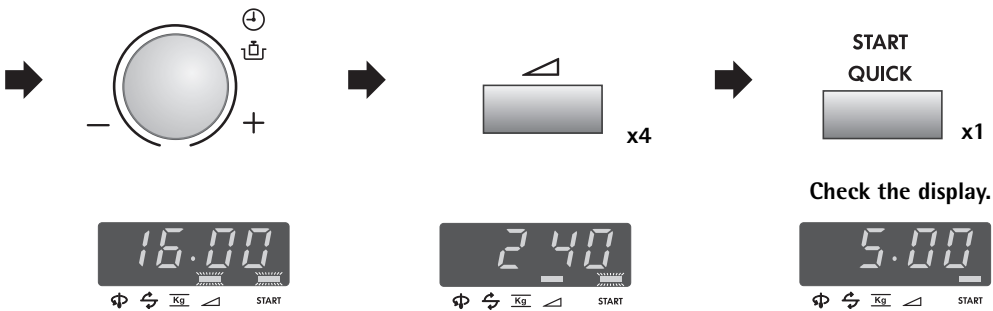

(The oven will begin to cook for 5 minutes on 800 W, and then for 16 minutes on 240 W).

# Other convenient functions

## 2. QUICK COOK FUNCTION

The **START/QUICK** button allows you to operate the two following functions:

### a. Direct start

You can directly start cooking on 800 W microwave power level for 30 seconds by pressing the **START/QUICK** button.



#### NOTE:

To avoid the misuse by children the **START/QUICK** button can be used only within 3 minutes after preceding operation, i.e., closing the door, pressing the **STOP** button or cooking completion.

### b. Extend the cooking time

You can extend the cooking time during manual cooking for multiples of 30 seconds if the button is pressed while the oven is in operation.

## 3. TO CHECK THE POWER LEVEL

To check the microwave power level during cooking press the **MICROWAVE POWER LEVEL** button.



x1

As long as your finger is touching the **MICROWAVE POWER LEVEL** button the power level will be displayed.

The oven continues to count down although the display shows the power level.

## 4. SAFETY LOCK FUNCTION

### TO SET THE SAFETY LOCK FUNCTION

1. Press and hold the **STOP** key for 3 seconds.



x1 for 3 seconds

The display will show:



### TO CANCEL THE SAFETY LOCK FUNCTION

1. Press and hold the **STOP** key for 3 seconds.



x1 for 3 seconds

The display will show the time of day, if set.

**NOTE:** When Safety Lock is set you cannot input any buttons except the **STOP** button.

# Automatic operation

The **AUTOMATIC** function automatically works out the correct cooking mode and cooking time. You can choose from 7 **AUTOCOOK** menus and 5 **AUTO DEFROST** menus. What you need to know when using this automatic function:

1. Press the **AUTOMATIC PROGRAMMES** button once, the display will appear as shown.  
The menu can be chosen by pressing the **AUTOMATIC PROGRAMMES** button until the desired menu number is displayed.  
See pages 15 - 16 "AUTOMATIC charts".  
To select a defrost menu, press the **AUTOMATIC PROGRAMMES** button at least 8 times. If you press the button 8 times, **Rd - 1** will appear in the display. The menu will be changed automatically by holding down the **AUTOMATIC PROGRAMMES** button.
2. The weight or quantity of the food can be input by rotating the **TIMER/WEIGHT** knob until the desired weight is displayed.
  - Enter the weight of the food only. Do not include the weight of the container.
  - For food weighing more or less than weights given in the cooking chart, use manual programmes. For best results, follow the cooking charts on pages 18 - 19.
3. To start cooking press **START/QUICK** button.  
When action is required (e.g. to turn food over), the oven stops and the audible signals sound, remaining cooking time and any indicator will flash on the display. To continue cooking, press the **START/QUICK** button.

1.



2.

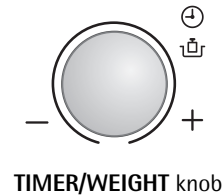

3.



The final temperature will vary according to the initial food temperature. Check food is piping hot after cooking. If necessary, you can extend the cooking time and change the power level.

## Example:





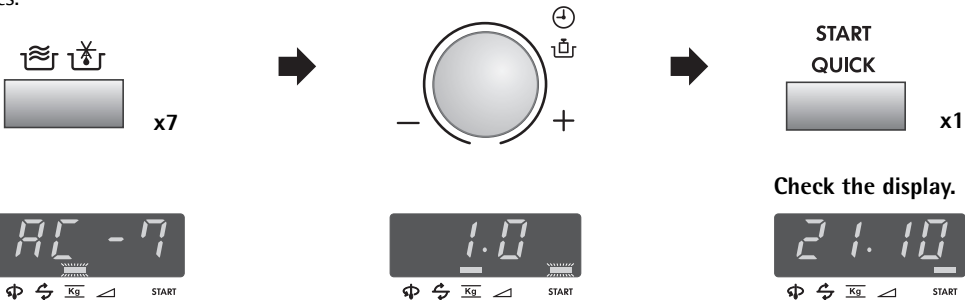









To cook gratin weighing 1,0 kg using Autocook AC-7.

1. Select the menu required by pressing the **AUTOMATIC PROGRAMMES** button seven times.
2. Enter the weight by rotating the **TIMER/WEIGHT** knob clockwise.
3. Press the **START/QUICK** button.













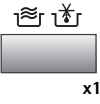

## **i** Automatic charts

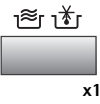
BUTTON	AUTOCOOK NO.	WEIGHT (Increasing Unit) / UTENSILS	PROCEDURE
 x1	<b>AC-1 Cook</b> Frozen Vegetables e.g. Brussel sprouts, green beans, peas, mixed vegetables 	0,1 - 0,6 kg (100 g) (initial temp -18°C) Bowl and lid	<ul style="list-style-type: none"> <li>• Add 1 tbsp water per 100 g and salt as desired. (For mushrooms no additional water is necessary).</li> <li>• Cover with a lid.</li> <li>• When audible signal sounds, stir and re-cover.</li> <li>• After cooking, let stand for approx. 2 minutes.</li> </ul> <b>NOTE:</b> If frozen vegetables are compacted together, cook manually.
 x2	<b>AC-2 Cook</b> Fresh Vegetables 	0,1 - 0,6 kg (100 g) (initial temp 20°C) Bowl and lid	<ul style="list-style-type: none"> <li>• Cut into small pieces, eg. strips, cubes or slices.</li> <li>• Add 1 tbsp water per 100 g and salt as desired. (For mushrooms no additional water is necessary).</li> <li>• Cover with a lid.</li> <li>• When audible signal sounds, stir and re-cover.</li> <li>• After cooking, let the food stand for approx 2 minutes.</li> </ul>
 x3	<b>AC-3 Cook</b> Frozen Ready Meals Stirrable type e.g. Noodles, Bolognese, Chinese Menus. 	0,3 - 1,0 kg* (100 g) (initial temp -18°C) Bowl and lid * If the manufacturer instructs to add water, calculate the total amount for the programmes with additional liquid.	<ul style="list-style-type: none"> <li>• Transfer meal to suitable microwave-proof dish.</li> <li>• Add some liquid if recommended by the manufacturer.</li> <li>• Cover with a lid.</li> <li>• Cook without cover if the manufacturer instructs.</li> <li>• When audible signal sounds, stir and re-cover.</li> <li>• After cooking, stir and let stand for approx. 2 minutes.</li> </ul>
 x4	<b>AC-4 Cook</b> Frozen Gratin e.g. macaroni gratin, lasagne, etc. 	0,2 - 0,6 kg (100 g) (initial temp -18°C) Shallow, oval gratin dish and microwave cling film or original container and microwave cling film	<ul style="list-style-type: none"> <li>• Remove the frozen gratin from the package. If the container is not suitable for microwave ovens, transfer gratin to a suitable microwave proof dish.</li> <li>• Cover with microwave cling film.</li> <li>• If the container is suitable for microwave ovens, remove original paper cover and cover with microwave cling film.</li> <li>• After cooking, let stand for approx. 5 minutes.</li> </ul>
 x5	<b>AC-5 Cook</b> Boiled Potatoes Jacket Potatoes 	0,1 - 0,8 kg (100 g) (initial temp 20°C) Bowl and lid	Boiled Potatoes: Peel the potatoes and cut them into similar sized pieces. Jacket Potatoes: Choose potatoes of similar size and wash them. <ul style="list-style-type: none"> <li>• Put the boiled or jacket potatoes into a bowl.</li> <li>• Add the required amount of water (per 100 g), approx 2 tbsp and a little salt.</li> <li>• Cover with a lid.</li> <li>• When audible signal sounds, stir and re-cover.</li> <li>• After cooking, let the potatoes stand for approx. 2 minutes.</li> </ul>
 x6	<b>AC-6 Cook</b> Fish fillet with sauce 	0,4 - 1,2 kg* (100 g) (initial temp fish 5°C, Sauce 20°C) Gratin dish and microwave cling film	<ul style="list-style-type: none"> <li>• See recipes for "Fish Fillet with Sauce" on page 17.</li> </ul> * Total weight of all ingredients.
 x7	<b>AC-7 Cook</b> Gratin 	0,5 - 1,5 kg* (100 g) (initial temp 20°C) Gratin dish	<ul style="list-style-type: none"> <li>• See recipes for "Gratin" on page 17.</li> </ul> * Total weight of all ingredients.

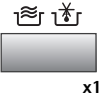
## Automatic charts

BUTTON	AUTO DEFROST NO.	WEIGHT(Increasing Unit) / UTENSILS	PROCEDURE
 x8	<b>Ad-1 Defrost</b> Steak and Chops 	0,2 - 0,8 kg (100 g) (initial temp -18°C) (See note below)	<ul style="list-style-type: none"> <li>Place the food in a flan dish in the centre of the turntable.</li> <li>When the audible signal sounds, turn the food over, rearrange and separate. Shield thin parts and warm spots with small pieces of aluminium foil.</li> <li>After defrosting, wrap in aluminium foil for 10 - 15 minutes, until thoroughly defrosted.</li> </ul>
 x9	<b>Ad-2 Defrost</b> Minced Meat 	0,2 - 0,8 kg (100 g) (initial temp -18°C) (See note below)	<ul style="list-style-type: none"> <li>Place the block of minced meat in a flan dish in the centre of the turntable.</li> <li>When the audible signal sounds, turn the food over. Remove the defrosted parts if possible.</li> <li>After defrosting cover with aluminium foil, stand for 5 - 10 minutes, until thoroughly defrosted.</li> </ul>
 x10	<b>Ad-3 Defrost</b> Poultry 	0,9 - 1,5 kg (100 g) (initial temp -18°C) ( See note below)	<ul style="list-style-type: none"> <li>Place the poultry in a flan dish in the centre of the turntable.</li> <li>When the audible signal sounds, turn over and shield thin parts and warm spots with small pieces of aluminium foil.</li> <li>After defrosting, rinse with cold water, cover with aluminium foil and stand for 15 - 30 minutes until thoroughly defrosted.</li> <li>Finally clean the poultry under running water.</li> </ul>
 x11	<b>Ad-4 Defrost</b> Cake 	0,1 - 1,4 kg (100 g) (initial temp -18°C) Plate	<ul style="list-style-type: none"> <li>Remove all packaging from the cake.</li> <li>Place directly on the turntable, or on a plate in the middle of the turntable.</li> <li>After defrosting, cut the cake into similar sized pieces keeping space between each piece and let stand for 10 - 30 minutes until evenly defrosted.</li> </ul>
 x12	<b>Ad-5 Defrost</b> Bread 	0,1 - 1,0 kg (100 g) (initial temp -18°C) Flan dish (Only sliced bread is recommended for this programme.)	<ul style="list-style-type: none"> <li>Distribute in a flan dish in the centre of the turntable. For 1,0 kg distribute directly on the turntable.</li> <li>When the audible signal sounds, turn over, rearrange and remove defrosted slices.</li> <li>After defrosting cover in aluminum foil and stand for 5 - 15 minutes, until thoroughly defrosted.</li> </ul>

### NOTES: Auto Defrost

- Steaks and Chops should be frozen in one layer.
- Minced meat should be frozen in a thin shape.
- After turning over, shield the defrosted portions with small, flat pieces of aluminium foil.
- The poultry should be processed immediately after defrosting.
- Gateaux topped and coated with cream are very sensitive to microwave energy. For the best result, if the cream begins to soften rapidly, it is best to remove it from the oven immediately and stand for 10 - 30 minutes at room temperature.

# **i** Recipes for automatic AC-6 & AC-7

## **FISH FILLET WITH SAUCE (AC-6)**

### **Fish fillet with piquant sauce**

#### Ingredients

0,4 kg	0,8 kg	1,2 kg	
140 g	280 g	420 g	canned tomatoes (drained)
40 g	80 g	120 g	corn
4 g	8 g	12 g	chilli sauce
12 g	24 g	36 g	onion (finely chopped)
1 tsp	1-2 tsp	2 tsp	red wine vinegar
			mustard, thyme, cayenne pepper
200 g	400 g	600 g	fish fillet
			salt

#### Preparation

1. Mix ingredients for the sauce.
2. Place the fish fillet in a round gratin dish with the thin ends toward the centre and sprinkle with salt.
3. Spread the sauce on the fish fillet.
4. Cover with microwave cling film and cook on **AUTOCOOK AC-6**, "Fish Fillet with Sauce".
5. After cooking, let stand for approx. 2 minutes.

## **FISH FILLET WITH SAUCE (AC-6)**

### **Fish fillet with curry sauce**

#### Ingredients

0,4 kg	0,8 kg	1,2 kg	
200 g	400 g	600 g	fish fillet
			salt
40 g	80 g	120 g	banana (sliced)
160 g	320 g	480 g	ready-made curry sauce

#### Preparation

1. Place the fish fillet in a round gratin dish with the thin ends toward the centre and sprinkle with salt.
2. Spread the banana and the ready-made curry sauce on the fish fillet.
3. Cover with microwave cling film and cook on **AUTOCOOK AC-6**, "Fish Fillet with Sauce".
4. After cooking, let stand for approx. 2 minutes.

## **GRATIN (AC-7)**

### **Spinach gratin**

#### Ingredients

0,5 kg	1,0 kg	1,5 kg	
5 g	10 g	15 g	butter or margarine (to grease the dish)
150 g	300 g	450 g	leaf spinach (defrosted, drained)
15 g	30 g	45 g	onion (finely chopped)
			salt, pepper & nutmeg
150 g	300 g	450 g	boiled potatoes (sliced)
35 g	75 g	110 g	cooked ham (diced)
50 g	100 g	150 g	crème fraîche
1	2	3	eggs
40 g	75 g	115 g	grated cheese
			paprika powder

#### Preparation

1. Mix together the leaf spinach with the onion and season with salt, pepper and nutmeg.
2. Grease the gratin dish. Place alternate layers of potato slices, diced ham and spinach in the dish. The top layer should be spinach.
3. Mix the eggs with crème fraîche, add salt and pepper and pour over the vegetables.
4. Cover the gratin with the grated cheese, sprinkle with paprika powder and cook on **AUTOCOOK AC-7**, "Gratin".
5. After cooking, let stand for 5-10 minutes.

## **GRATIN (AC-7)**

### **Potato-courgette-gratin**

#### Ingredients

0,5 kg	1,0 kg	1,5 kg	
200 g	400 g	600 g	boiled potatoes (sliced)
115 g	230 g	345 g	courgette (finely sliced)
75 g	150 g	225 g	crème fraîche
1	2	3	eggs
1/2	1	2	clove of garlic (crushed)
			salt & pepper
40 g	80 g	120 g	feta cheese (diced)
10 g	20 g	30 g	sunflower kernel
			paprika powder

#### Preparation

1. Grease the gratin dish and place alternate layers of potato slices and courgette in the dish.
2. Mix the eggs with crème fraîche, season with salt, pepper and garlic and pour over the vegetables.
3. Crumble the feta cheese and sprinkle over the gratin.
4. Finally sprinkle the gratin with sunflower kernel and paprika powder and cook on **AUTOCOOK AC-7**, "Gratin".
5. After cooking, let stand for 5-10 minutes.

# Cooking charts

## ABBREVIATIONS USED

tblsp = tablespoon	Cup = cupful	g = gram	ml = millilitre	min = minutes
tsp = teaspoon	KG = kilogram	l = litre	cm = centimetre	

## TABLE: HEATING FOOD & DRINK

Food / Drink	Quantity -g/ml-	Power -Setting-	Time -Min-	Hints
Coffee, 1 cup	150	800 W	approx.1	do not cover
Milk, 1 cup	150	800 W	approx.1	do not cover
Water, 1 cup	150	800 W	1 1/2 -2	do not cover, bring to the boil
6 cups	900	800 W	10-12	do not cover, bring to the boil
1 bowl	1000	800 W	11 1/2-13	cover, bring to the boil
Platters (Vegetables, meat and trimmings)	400	800 W	3-6	sprinkle some water onto the sauce, cover stir half way through the heating time
Soup / Stew	200	800 W	1 1/2-2 1/2	cover, stir after heating
Vegetables	200	800 W	2-2 1/2	if necessary add some water, cover
	500	800 W	4-5	stir half way through the heating time
Meat, 1 slice*	200	800 W	3-4	thinly spread sauce over the top, cover
Fish fillet*	200	800 W	2-3	cover
Cake, 1 piece	100	400 W	1/2	place on a cake stand
Baby food, 1 glass	190	400 W	approx.1	remove the lid, after heating stir well and test the temperature
Melting butter or margarine*	50	800 W	1/2	Cover
Melting chocolate	100	400 W	2-3	stir from time to time

\* Refrigerator temperature

## TABLE: DEFROSTING & COOKING

Food	Quantity -g-	Power -Setting-	Time -Min-	Added water -tblsp-	Hints	Standing time -Min-
Fish fillet	300	800 W	10-12	-	cover	1-2
One plate meal	400	800 W	9-11	-	cover, stir after 6 minutes	2
Broccoli	300	800 W	7-9	3-5	cover, stir half way through cooking time	2
Peas	300	800 W	7-9	3-5	cover, stir half way through cooking time	2
Mixed vegetables	500	800 W	11-13	3-5	cover, stir half way through cooking time	2

## TABLE: DEFROSTING

Food	Quantity -g-	Power -Setting-	Time -Min-	Hints	Standing time -Min-
Roast meat (e.g. pork, beef, lamb, veal)	1500	80 W	58-64	place on an upturned plate, turn half way through defrosting time	30-90
	1000	80 W	42-48		30-90
	500	80 W	19-23		30-90
Goulash	500	240 W	8-12	separate and stir half way through defrosting time	10-15
Sausages, 8 pieces	600	240 W	6-9	place next to each other,	5-10
4 pieces	300	240 W	4-5	turn half way through defrosting time	5-10
Chicken legs	200	240 W	4-5	turn half way through defrosting time	10-15
Fish fillet	400	240 W	7-10	turn half way through defrosting time	5-10
Bread rolls, 2 pieces	80	240 W	app.1	only partially defrost	-
Cakes, 1 piece	100-150	80 W	2-5	place on a cake stand	5
Fruit: strawberries	250	240 W	4-5	spread them out evenly	5
raspberries, cherries, plums				turn half way through defrosting time	

The times shown in the table are guidelines which may vary according to freezing temperature, quality and weight of the foodstuffs.

# Cooking charts

**TABLE: COOKING MEAT, FISH, POULTRY AND FRESH VEGETABLES**

Fish and Poultry or Vegetable	Quantity -g-	Power -Setting-	Time -Min-	Hints	Standing time -Min-
Roasts (pork, veal, lamb)	500	800 W	8-10*	season to taste, place in a shallow flan dish turn over after *	10
	1000	400 W	10-12		10
		800 W	19-21*		10
	1500	400 W	11-14		
		800 W	33-36*		10
		400 W	13-17		
Roast beef (medium)	1000	800 W	9-11*	season to taste, place in a quiche dish, turn over after *	10
		400 W	5-7		
Fish fillet	200	800 W	3-4	season to taste, place on a plate, cover	3
Chicken	1200	800 W	21-24	season to taste, place in a casserole dish, turn half way through cooking time	3
Chicken legs	200	800 W	3-4	season to taste, place on a plate, cover	3
Broccoli	500	800 W	9-11	divide into florets, cover, stir occasionally during cooking	4-5 tbsps
Peas	500	800 W	9-11	cover, stir occasionally during cooking	4-5 tbsps
Onions	250	800 W	5-7	whole, cook in microwave cling film	-
Carrots	500	800 W	10-12	cut into rings, cover, stir occasionally during cooking	4-5 tbsps
	300	800 W	7-9		
Boiled potatoes (salted)	500	800 W	9-11	cut into large pieces of a similar size, add a little salt, cover, stir occasionally during cooking	150 ml

## Recipes

All the recipes in this book are calculated on the basis of 4 servings - unless otherwise stated.

### ADAPTING RECIPES FOR THE MICROWAVE OVEN

If you would like to adapt your favourite recipes for the microwave, you should take note of the following:

Shorten cooking times by a third to a half. Follow the example of the recipes in this book.

Foods which have a high moisture content such as meat, fish, poultry, vegetables, fruit, stews and soups can be prepared in your microwave without any

difficulty. Foods which have little moisture, such as platters of food, should have the surface moistened prior to heating or cooking.

The amount of liquid to be added to raw foods, which are to be braised, should be reduced to about two thirds of the quantity in the original recipe. If necessary, add more liquid during cooking.

The amount of fat to be added can be reduced considerably. A small amount of butter, margarine or oil is sufficient to flavour food. For this reason your microwave is excellent for preparing low-fat foods as part of a diet.

### Mushroom soup

Total cooking time: approx. 13-17 Minutes

Utensils: Bowl with lid (2 l Capacity)

Ingredients

- 200 g mushrooms, sliced
- 1 onion (50 g), finely chopped
- 300 ml meat stock
- 300 ml cream
- 2<sup>1</sup>/<sub>2</sub> tbsps flour (25 g)
- 2<sup>1</sup>/<sub>2</sub> tbsps butter or margarine (25 g)
- salt & pepper
- 1 egg
- 150 g crème fraîche

1. Place the vegetables and the stock in the bowl, cover and cook.  
**8-9 min.**  $\triangleleft$  **800 W**
2. Blend all the ingredients in the mixer.
3. Mix the flour and butter to a dough and smooth into the soup. Season with salt and pepper, cover and cook. Stir after cooking.  
**4-6 min.**  $\triangleleft$  **800 W**
4. Mix the egg yolk with the cream, gradually stir into the soup. Heat for a short time, but do not let it boil!  
**1-2 min.**  $\triangleleft$  **800 W**  
Allow the soup to stand for about 5 minutes after cooking.

# Recipes

## Camembert toast

Total cooking time: approx. 1½-2½ minutes

Utensils:

Ingredients

- 4 slices of bread for toasting
- 2 tbsp butter or margarine (20 g)
- 150 g camembert
- 4 tsp cranberry jelly
- cayenne pepper

1. Toast the bread and spread with butter.
2. Cut the Camembert into slices and arrange on top of the toast. Put the cranberry jelly in the middle of the cheese and sprinkle with cayenne pepper.
3. Place the toast on a plate and heat for **1½-2½ min. ◁ 800 W**

Tip: You can vary this recipe according to your taste. For example, you can use fresh mushrooms and grated cheese or cooked ham, asparagus and Emmental cheese.

## Zürich veal in cream

Total cooking time: approx. 11-15 minutes

Utensils: Dish with lid (2 l capacity)

Ingredients

- 600 g veal fillet
- 1 tbsp butter or margarine
- 1 onion (50 g), finely chopped
- 100 ml white wine
- seasoned gravy browning, for approx. ½ l gravy
- 300 ml cream
- 1 tbsp parsley, chopped

1. Cut the fillet into finger-width strips.
2. Grease the dish all over with the butter. Put the onion and the meat into the dish, cover and cook. Stir once during cooking. **7-10 min. ◁ 800 W**
3. Add the white wine, gravy browning and cream, stir, cover and continue cooking. Stir occasionally. **4-5 min. ◁ 800 W**
4. Test the veal, stir the mixture once more and allow to stand for approx. 5 minutes. Serve garnished with parsley.

## Lasagne

Total cooking time 22-26 minutes

Utensils: Bowl with lid (2 l capacity)

Shallow square soufflé mould with lid (approx 20 x 20 x 6 cm)

Ingredients

- 300 g tinned tomatoes
- 50 g ham, finely cubed
- 1 onion (50 g), finely chopped
- 1 clove of garlic, crushed
- 250 g minced meat (beef)
- 2 tbsp mashed tomato (30 g)
- salt & pepper
- oregano, thyme, basil, nutmeg
- 150 ml cream (crème fraîche)
- 100 ml milk
- 50 g grated Parmesan cheese
- 1 tsp mixed chopped herbs
- 1 tsp olive oil
- 1 tsp vegetable oil to grease the mould
- 125 g lasagne verde
- 1 tbsp grated Parmesan cheese
- 1 tbsp butter or margarine

1. Cut the tomatoes into slices, mix with the ham and onion, garlic, minced meat and mashed tomato. Season and cook with the lid on. **7-9 min. ◁ 800 W**
  2. Mix the cream with the milk, Parmesan cheese, herbs, oil, and spices.
  3. Grease the soufflé mould and cover the bottom of the mould with about ½ of the pasta. Put half of the minced meat mixture on the pasta and pour on some sauce. Put an additional ½ of the pasta on top followed by another layer of the minced meat mixture and some sauce, finishing with the remaining pasta on top. Finally, cover the pasta with lots of sauce and sprinkle with Parmesan cheese. Place butter flakes on top and cook with the lid on. **15-17 min. ◁ 560 W**
- After cooking, let the lasagne stand for approximately 5-10 minutes.

# Recipes

## Braised lamb with green beans

Total cooking time: approx. 20-24 minutes  
Utensils: Shallow, oval soufflé mould with lid  
(about 26 cm long)

### Ingredients

- 1-2 tomatoes (100 g)
- 400 g lamb, boned
- 1 tsp butter or margarine for greasing the bowl
- 1 onion (50 g), finely chopped
- 1 clove garlic, crushed
- salt & pepper
- sugar
- 250 g tinned green beans

1. Skin and remove the stalks of the tomatoes, then purée in a blender or food processor.
2. Cut the lamb into large chunks. Grease the bowl with butter. Add meat, onions and garlic, season, cover and cook.

**9-11 min.**  **800 W**

3. Add beans and puréed tomatoes to the meat, cover and continue cooking.

**11-13 min.**  **560 W**

After cooking, leave the lamb to stand for approximately 5 minutes.

**Tip:** If you prefer to use fresh beans, these should be pre-cooked.

## Sole fillets

Total cooking time: approx. 13-16 minutes  
Utensils: Shallow, oval oven dish with microwave cling film (approx. 26 cm long)

### Ingredients

- 400 g sole fillets
- 1 lemon, whole
- 2 tomatoes (150 g)
- 1 tsp butter or margarine for greasing
- 1 tbs vegetable oil
- 1 tbs parsley, chopped
- salt & pepper
- 4 tbs white wine (30 ml)
- 2 tbs butter or margarine (20 g)

1. Wash the sole fillets and pat them dry. Remove any bones.
2. Cut the lemon and the tomatoes into thin slices.
3. Grease the oven dish with butter. Place the fish fillets inside and drizzle the vegetable oil over them.
4. Sprinkle parsley over the fish, place the tomato slices on top and season. Place the lemon slices on top of the tomatoes and pour the white wine over them.
5. Place small pats of butter on top of the lemon, cover and cook.

**13-16 min.**  **800 W**

After cooking allow the fish fillets to stand for approx. 2 minutes.

**Tip:** This recipe can also be used for Haddock, Halibut, Mullet, Plaice or Cod.

## Ratatouille

Total cooking time 19-21 minutes  
Utensils: Bowl with lid (2 l capacity)  
Ingredients

- 5 tbs olive oil (50 ml)
- 1 clove garlic, crushed
- 1 onion (50 g), sliced
- 1 small aubergine (250 g), cut into cubes
- 1 courgette (200 g), into cubes
- 1 pepper (200 g), cut into large cubes
- 1 small fennel (75 g) cut into large cubes
- 1 bouquet garni
- 200 g tinned artichoke hearts, cut into quarters
- salt & pepper

1. Place the olive oil and garlic clove in the bowl. Add the prepared vegetables, except the artichoke hearts, and season with pepper. Add the bouquet garni, cover and cook, stirring once.

**19-21 min.**  **800 W**

For the last 5 minutes, add the artichoke hearts and heat.

2. Season the ratatouille to taste with salt and pepper. Remove the bouquet garni before serving. After cooking, leave the ratatouille to stand for around 2 minutes.

**Tip:** Ratatouille can be served hot with meat dishes. Served cold, it also makes an excellent starter.

**Tip:** A bouquet garni consists of: one stalk of parsley, a bunch of herbs suitable for seasoning soup, one stalk of lovage, one stalk of thyme, several bay leaves.

# Recipes

## Baked potatoes

Total cooking time 12-16 minutes

Utensils: Bowl with lid (2 l capacity)  
China plate

### Ingredients

4 medium sized potatoes (400 g)  
100 ml water  
60 g ham, cut into fine cubes  
1/2 onion (25 g) finely cubed  
75-100 ml milk  
2 tbsp grated Parmesan cheese (20 g)  
salt & pepper  
2 tbsp grated Emmental cheese

1. Place the potatoes in a dish, add the water, cover and cook. Rearrange halfway through cooking.

**8-10 min.** ◀ **800 W**

Leave to cool.

2. Cut the potatoes lengthwise and carefully remove the potato from the skin. Mix the potato with the ham, onion, milk and Parmesan cheese to an even consistency. Season with salt and pepper.
3. Fill the potato skins with potato mixture and sprinkle with Emmental cheese. Place potatoes on a plate and cook.

**4-6 min.** ◀ **800 W**

After cooking, leave to stand for approximately 2 minutes.

## Fruit Jelly with vanilla sauce

Total cooking time 10-13 minutes

Utensils: Dish with lid (2 l capacity)  
Dish with lid (1 l capacity)

### Ingredients

150 g redcurrants, washed and stalks removed  
150 g strawberries, washed and haulms removed  
150 g raspberries, washed and haulms removed  
250ml white wine  
100 g sugar  
50 ml lemon juice  
8 gelatin leaves  
300 ml milk  
inside of 1/2 vanilla pod  
30 g sugar  
15 g food thickener

Tip: You can also use defrosted frozen fruits.

1. Put some of the fruit to one side for decoration. Purée the rest of the fruit with the white wine, put it into a dish, cover and heat.

**7-9 min.** ◀ **800 W**

Fold in the sugar and the lemon juice.

2. Soak the gelatin in cold water for approx. 10 minutes, then take it out and squeeze dry. Stir the gelatin in with the hot purée until it has dissolved. Place the jelly in the refrigerator and leave to set.
3. To make the vanilla sauce; put the milk into the other dish. Slit the vanilla pod and remove the inside. Stir this in with the milk, together with the sugar and the food thickener, cover and cook, stirring during cooking and again at the end.

**3-4 min.** ◀ **800 W**

4. Turn out the jelly onto a plate and decorate with the whole fruit. Add the vanilla sauce.



# Care & cleaning

**CAUTION: DO NOT USE COMMERCIAL OVEN CLEANERS, STEAM CLEANERS, ABRASIVE, HARSH CLEANERS, ANY THAT CONTAIN SODIUM HYDROXIDE OR SCOURING PADS ON ANY PART OF YOUR MICROWAVE OVEN.**

**CLEAN THE OVEN AT REGULAR INTERVALS AND REMOVE ANY FOOD DEPOSITS. Failure to maintain the oven in a clean condition could lead to a deterioration of the surface that could adversely affect the life of the appliance and possibly result in a hazardous situation.**

## Oven exterior

The outside of your oven can be cleaned easily with mild soap and water. Make sure the soap is wiped off with a moist cloth, and dry the exterior with a soft towel.

## Oven controls

Open the door before cleaning to de-activate the oven controls. Care should be taken when cleaning the oven control. Using a cloth dampened with water only, gently wipe the panel until it becomes clean. Avoid using excessive amounts of water. Do not use any sort of chemical or abrasive cleaner.

## Oven Interior

1. For cleaning, wipe any splatters or spills with a soft damp cloth or sponge after each use while the oven is still warm. For heavier spills, use a mild soap and wipe several times with a damp cloth until all residues are removed. Do not remove the waveguide cover.
2. Make sure that mild soap or water does not penetrate the small vents in the walls which may cause damage to the oven.
3. Do not use spray type cleaners on the oven interior.

## Turntable & turntable support

Remove the turntable and turntable support from the oven. Wash the turntable and turntable support in mild soapy water. Dry with a soft cloth. Both the turntable and the turntable support are dishwasher safe.

## Door

To remove all trace of dirt, regularly clean both sides of the door, the door seals and sealing surfaces with a soft, damp cloth.

**NOTE:** A steam cleaner should not be used.

# What to do if...

## ... the microwave appliance is not working properly ?

Check that

- the fuses in the fuse box are working,
- there has not been a power outage.
- If the fuses continue to blow, please contact a qualified electrician.

## ... the microwave mode is not working ?

Check that

- the door is properly closed,
- the door seals and their surfaces are clean,
- the START/QUICK-button has been pressed

## ... the turntable is not turning ?

Check that

- the turntable support is correctly connected to the drive,
- the ovenware does not extend beyond the turntable,
- food does not extend beyond the edge of the turntable preventing it from rotating.
- there is nothing in the well beneath the turntable.

## ... the microwave will not switch off ?

- Isolate the appliance from the fuse box.
- Contact your local Service Force Centre.

## ... the interior light is not working ?

- Call your local Service Force Centre. The interior light bulb can be exchanged only by trained Service Force technicians.

## ... the food is taking longer to heat through and cook than before ?

- Set a longer cooking time (double quantity = nearly double time) or
- if the food is colder than usual, rotate or turn from time to time or
- set a higher power setting.

**NOTE:** If you cook the food over the standard time with only 800 W, the power of the oven will lower automatically to avoid overheating. (The microwave power level will be reduced to 560 W). After pausing for 90 seconds, 800 W power can be reset.

Cooking Mode	Standard time	Reduced power
Microwave 800 W	20 minutes	Microwave 560 W

# Service & spare parts

If you wish to purchase spare parts or require an engineer, contact your local AEG-Electrolux Service Force Centre by telephoning:

**08705 929 929**

Your telephone call will be automatically routed to the Service Force Centre covering your post code area.

For the address of your local Service Force Centre and further information about Service Force, please visit the website at:

**[www.serviceforce.co.uk](http://www.serviceforce.co.uk)**

When you contact the Service Force Centre they will need the following information:

1. Your name & address, including post code.
2. Your telephone number
3. Clear and concise details of the fault.
4. The model and serial number of the appliance (found on the rating plate).
5. The purchase date:  
Please note that a valid purchase receipt or guarantee documentation is required for in-guarantee service calls.

## Customer care

For general enquiries concerning your AEG-Electrolux appliance or for further information on AEG-Electrolux products please contact our Customer Care Department by letter or telephone at the address below or visit our website at:

**[www.aeg.co.uk](http://www.aeg.co.uk)**

Customer Care Department  
Major Appliances  
Addington Way  
Luton  
Bedfordshire  
LU4 9QQ

Tel. 08705 350350 (\*)

(\*) Calls may be recorded for training purposes.

For Customer Service in Ireland please contact us at the address below:

AEG-Electrolux  
Electrolux Group (Irl) Ltd  
Long Mile Road  
Dublin 12  
Republic of Ireland

Tel: + 353 (0)1 4090754

Email: [service.eid@electrolux.ie](mailto:service.eid@electrolux.ie)

# Guarantee conditions

## Standard guarantee conditions

We, AEG-Electrolux, undertake that if within 12 months of the date of the purchase this AEG-Electrolux appliance or any part thereof is proved to be defective by reason only of faulty workmanship or materials, we will, at our discretion repair or replace the same FREE OF CHARGE for labour, materials or carriage on condition that:

- The appliance has been correctly installed and used only on the electricity or gas supply stated on the rating plate.
- The appliance has been used for normal domestic purposes only, and in accordance with the manufacturer's operating and maintenance instructions.
- The appliance has not been serviced, maintained, repaired, taken apart or tampered with by any person not authorised by us.
- All service work under this guarantee must be undertaken by a Service Force Centre. Any appliance or defective part replaced shall become the Company's property.
- This guarantee is in addition to your statutory and other legal rights.
- Home visits are made between 8.30am and 5.30pm Monday to Friday.  
Visits may be available outside these hours in which case a premium will be charged.

## Exclusions

This guarantee does not cover:

- Damage or calls resulting from transportation, improper use or neglect, the replacement of any light bulbs or removable parts of glass or plastic.
- Costs incurred for calls to put right an appliance which is improperly installed or calls to appliances outside the United Kingdom.
- Appliances found to be in use within a commercial environment, plus those which are subject to rental agreements.
- Products of AEG-Electrolux manufacture which are not marketed by AEG-Electrolux.

## European Guarantee

If you should move to another country within Europe then your guarantee moves with you to your new home subject to the following qualifications:

- The guarantee starts from the date you first purchased your product.
- The guarantee is for the same period and to the same extent for labour and parts as exists in the new country of use for this brand or range of products.
- This guarantee relates to you and cannot be transferred to another user.
- Your new home is within the European Community (EC) or European Free Trade Area.
- The product is installed and used in accordance with our instructions and is only used domestically, i.e. a normal household.
- The product is installed taking into account regulations in your new country.

Before you move please contact your nearest Customer Care centre, listed below, to give them details of your new home. They will then ensure that the local Service Organisation is aware of your move and able to look after you and your appliances.

France	Senlis	+33 (0) 3 44 62 29 29
Germany	Nürnberg	+49 (0) 800 234 7378
Italy	Pordenone	+39 (0) 800 117511
Sweden	Stockholm	+46 (0) 8 672 5360
UK	Slough	+44 (0) 1753 219899

# Specifications

AC Line Voltage	: 230-240 V, 50 Hz, single phase
Distribution line fuse/circuit breaker	: Minimum 10 A
AC Power required:	Microwave : 1.2 kW
Output power:	Microwave : 800 W (IEC 60705)
Microwave Frequency	: 2450 MHz * (Group 2 / Class B)
Outside Dimensions:	MC1751E : 492 mm (W) x 370 mm (H) x 316 mm (D) MC1761E : 592 mm (W) x 370 mm (H) x 316 mm (D)
Cavity Dimensions	: 285 mm (W) x 202 mm (H) x 298 mm (D) **
Oven Capacity	: 17 litres **
Turntable	: ø 272 mm, glass
Weight	: approx. 15.5 kg
Oven lamp	: 25 W/240 - 250 V

\* This Product fulfils the requirement of the European standard EN55011.  
In conformity with this standard, this product is classified as group 2 class B equipment.  
Group 2 means that the equipment intentionally generates radio-frequency energy in the form of electromagnetic radiation for the heat treatment of food.  
Class B equipment means that the equipment is suitable to be used in domestic establishments.

\*\* Internal capacity is calculated by measuring maximum width, depth and height.  
Actual capacity for holding food is less.



This oven complies with the requirements of Directives 89/336/EEC and 73/23/EEC as amended by 93/68/EEC.  
SPECIFICATIONS ARE SUBJECT TO CHANGE WITHOUT NOTICE AS PART OF CONTINUOUS IMPROVEMENT

## Important information



### Ecologically responsible disposal of packaging materials and old appliances



#### Packaging materials

AEG-Electrolux microwave ovens require effective packaging to protect them during transportation. Only the minimum packaging necessary is used.

Packaging materials (e.g. foil or styrofoam) can place children at risk.



**Danger of suffocation. Keep packaging material away from children.**



All packaging materials used are environment friendly and can be recycled. The cardboard is made from recycled paper and the wooden parts are untreated. Plastic items are marked as follows:

«PE» polyethylene eg packaging film

«PS» polystyrene eg packaging (CFC-free)

«PP» polypropylene eg packaging straps

By using and re-using the packaging, raw materials are saved and waste volume is reduced.

Packaging should be taken to your nearest recycling centre.

Contact your local council for information.



#### Disposal of old appliances

Old appliances should be made safe before disposal by removing the plug, and cutting off and disposing of the power cable.

It should then be taken to the nearest recycling centre. Check with your local Council or Environmental Health Office to see if there are facilities in your area for recycling the appliance.

# i Installation

## INSTALLING THE APPLIANCE

1. Remove all packaging and check carefully for any signs of damage.
2. This oven is designed to fit into a 360 mm high cupboard as standard.  
When fitting into a 350 mm high cupboard:-  
Unscrew and remove the 4 feet from the bottom of the oven. There are 3 tall feet and 1 short foot. Replace the 3 tall feet with those provided in the accessory pack. Do not replace the short foot.
3. If fitting the microwave oven above a conventional oven (position A) then use the mylar sheet provided.

- a. Cut the Mylar sheet to fit the internal width of the unit.
- b. Peel back the protective cover on the tape and fix to the rear of the shelf so that it covers the service gap. (See diagram).

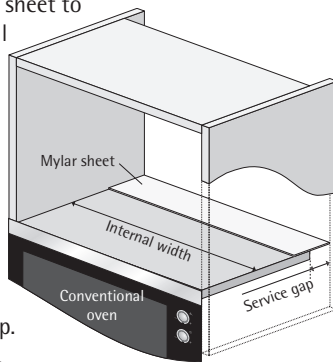

4. Fit the appliance into the kitchen cupboard slowly, and without force, until the front frame of the oven seals against the front opening of the cupboard.

5. Ensure the appliance is stable and not leaning. Ensure that a 5 mm gap is kept between the cupboard door above and the top of the frame (see diagram).



6. Fix the oven in position with the screws provided.

The fixing points are located on the top and bottom corners of the oven (see diagram, item 9, on page 4).

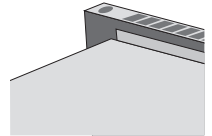

7. It is important to ensure that the installation of this product conforms to the instructions in this operation manual and the hob or conventional oven manufacturer's installation instructions.

## SAFE USE OF THE APPLIANCE

### If fitting the microwave in position B or C:

- The cupboard must be a minimum of 500 mm (E) above the worktop & must **not** be installed **directly** above a hob.
- This appliance has been tested and approved for use near domestic gas, electric and induction hobs only.
- Sufficient space between hob and microwave should be allowed to prevent overheating of microwave oven, surrounding cupboard and accessories.
- Do not operate the hob without pans when the microwave oven is operating.
- Care should be taken when attending to the microwave oven while the hob is on.

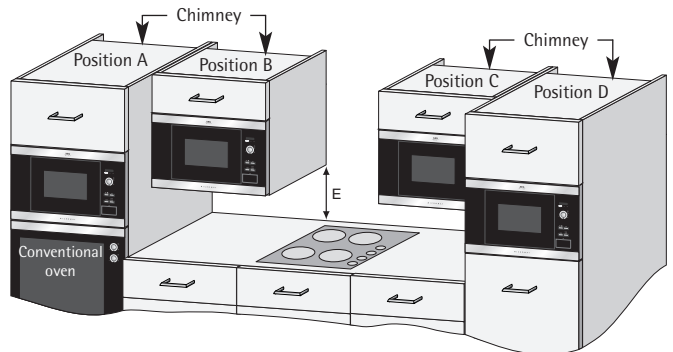

POSITION	NICHE SIZE			CHIMNEY (min)	Gap Between Cupboard & Ceiling
	W	D	H		
A	560	550	360	50	50
B + C	460	300	350	15	50
	460	300	360	15	50
	560	300	350	15	50
	560	300	360	15	50
D	460	500	350	40	50
	460	500	360	40	50
	560	500	350	40	50
	560	500	360	40	50

Measurements in (mm)

# Installation

## CONNECTING THE APPLIANCE TO THE POWER SUPPLY

- The electrical outlet should be readily accessible so that the unit can be unplugged easily in an emergency.
  - The socket should not be positioned behind the cupboard.
  - The best position is above the cupboard, see (A).
- When not connecting the power supply cord to position (A) it should be removed from the support clip (see diagram, item 13, on page 4) and routed under the oven.
- Connect the appliance a single phase 230–240 V/50 Hz alternating current via a correctly installed earth socket. The socket must be fused with a 10 A fuse.
  - If the appliance is to be operated in a non-European country, the supply voltage, current type and frequency of the appliance indicated on the rating plate must correspond with the specification of your power supply. The rating plate can be found on the inside face of the control panel.
  - The power supply cord may only be replaced by an electrician.
  - Before installing, tie a piece of string to the power supply cord to facilitate connection to point (A) when the appliance is being installed.
  - When inserting the appliance into the high-sided cupboard, DO NOT crush the power supply cord.

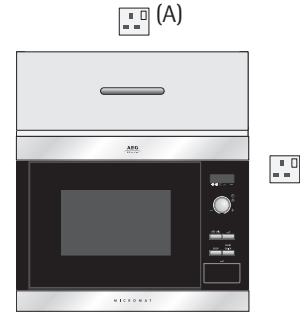

## ELECTRICAL CONNECTIONS



**WARNING:**  
**THIS APPLIANCE MUST BE EARTHED**  
The manufacturer declines any liability should this safety measure not be observed.

- If the plug that is fitted to your appliance is not suitable for your socket outlet, it must be cut off and the appropriate plug fitted.
- Remove the fuse from the cut off plug. The cut off plug should then be disposed of to prevent the hazard of shocks in case it should be plugged into a 13 Amp socket in another part of your home.

### IMPORTANT

The wires in the mains lead are coloured in accordance with the following code:

GREEN AND YELLOW	EARTH
BLUE	NEUTRAL
BROWN	LIVE

If you fit your own plug, the colours of the wires in the mains lead of your appliance may not correspond with the markings identifying the terminals in your plug, proceed as follows:

- Connect the green and yellow (earth) wire to the terminal in the plug which is marked with the letter "E" or the earth symbol () or coloured green and yellow.
- Connect the blue (neutral) wire to the terminal in the plug which is marked with the letter "N" or coloured black.
- Connect the brown (live) wire to the terminal in the plug which is marked with the letter "L" or coloured red.

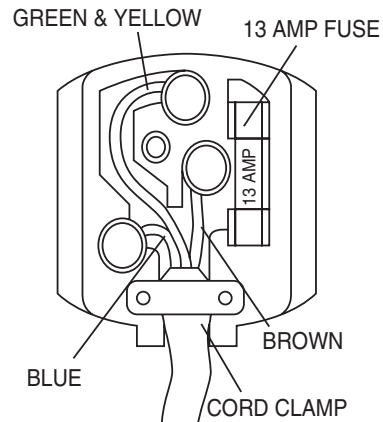



Major Appliances  
Addington Way  
Luton  
Bedfordshire  
LU4 9QQ

Telephone: 08705 350350

© Electrolux plc 2005

TINS-A348URR1 

Printed on paper manufactured with  
environmentally sound processes.  
He who thinks ecologically acts accordingly ...