

MCC4060E

Microwave oven with grill and convection

Operating instructions



PERFEKT IN FORM UND FUNKTION

AEG

Electrolux

Dear Customer,

Thank you for buying an AEG-Electrolux microwave oven and putting your trust in the AEG-Electrolux brand name.

Before using your AEG-Electrolux microwave oven for the first time, please read the instruction book thoroughly. This will enable you to take advantage of all the features that the appliance offers. It will also ensure trouble-free operation and minimize unnecessary service calls.



Important information concerning your safety or the operation of your appliance is noted by this symbol and/or mentions words such as «**Warning**», «**Take care**». Be sure to follow all instructions carefully.



Throughout the manual, this symbol guides you step by step when operating the appliance.



This symbol indicates further information concerning the use of the appliance.



The clover indicates energy-saving tips and hints for environmentally friendly use of your appliance.

In the event of malfunctioning, please follow the instructions given in the section «What to do if...»

Contents

Important safety instructions	2 - 3
Oven & accessories	4
Control panel	5
Before operation	6
Selecting the language	6
Using the STOP button	7
Setting the clock	7
Energy save mode	8
Microwave power levels	8
What are microwaves?	9
This is what your new combination microwave oven can do	9
Microwave cooking	10
Grill cooking	11
Heating without food	11
Convection cooking	12 - 13
Dual cooking	14 - 15
Other convenient functions	16 - 18
Suitable ovenware	19
Cooking charts	20
Recipes for glass tray and convection	21 - 22
Recipes for glass tray and grill	23
Automatic operations	24 - 25
Auto cook chart	26
Auto cook from frozen chart	27
Auto defrost chart	28 - 29
Recipes for auto cook AC-4	30
Recipes for auto cook AC-5	31 - 32
Care and cleaning	33
What to do if... ..	34
Service & spare parts	35
Customer care	35
Guarantee conditions	36
Specifications	37
Important information	38
Installation	39 - 40



The symbol  on the product or on its packaging indicates that this product may not be treated as household waste. Instead it shall be handed over to the applicable collection point for the recycling of electrical and electronic equipment. By ensuring this product is disposed of correctly, you will help prevent potential negative consequences for the environment and human health, which could otherwise be caused by inappropriate waste handling of this product. For more detailed information about recycling of this product, please contact your local city office, your household waste disposal service or the shop where you purchased the product.



Important safety instructions

IMPORTANT SAFETY INSTRUCTIONS: READ CAREFULLY AND KEEP FOR FUTURE REFERENCE

To avoid the danger of fire

The microwave oven should not be left unattended during operation. Power levels that are too high or cooking times that are too long may overheat foods resulting in a fire.

The electrical outlet must be readily accessible so that the unit can be unplugged easily in an emergency. Do not store or use the oven outdoors.

If food being heated begins to smoke, DO NOT OPEN THE DOOR. Turn off and unplug the oven and wait until the food has stopped smoking. Opening the door while food is smoking may cause a fire.

Only use microwave-safe containers and utensils. See Page 19.

Do not leave the oven unattended when using disposable plastic, paper or other combustible food containers.

Clean the waveguide cover, the oven cavity and the turntable after use. These must be dry and free from grease. Built-up grease may overheat and begin to smoke or catch fire.

Do not place flammable materials near the oven or ventilation openings. Do not block the ventilation openings. Remove all metallic seals, wire twists, etc., from food and food packages. Arcing on metallic surfaces may cause a fire.

Do not use the microwave oven to heat oil for deep frying. The temperature cannot be controlled and the oil may catch fire.

To make popcorn, only use special microwave popcorn makers.

Do not store food or any other items inside the oven.

Check the settings after you start the oven to ensure the oven is operating as desired.

See the corresponding hints in the cookery book section.

To avoid the possibility of injury

WARNING:

Do not operate the oven if it is damaged or malfunctioning. Check the following before use:

- The door; make sure the door closes properly and ensure it is not misaligned or warped.
- The hinges and door safety latches; check to make sure they are not broken or loose.
- The door seals and sealing surfaces; ensure that they have not been damaged.
- Inside the oven cavity or on the door; make sure there are no dents.
- The power supply cord and plug; ensure that they are not damaged.

Never adjust, repair or modify the oven yourself. It is hazardous for anyone other than a competent person to carry out any service or repair operation which involves the removal of a cover which gives protection against exposure to microwave energy.

Do not operate the oven with the door open or alter the door safety latches in any way.

Do not operate the oven if there is an object between the door seals and sealing surfaces.

Do not allow grease or dirt to build up on the door seals and adjacent parts. Follow the instructions for "Care & Cleaning" on page 33. Failure to maintain the oven in a clean condition could lead to a deterioration of the surface that could adversely affect the life of the appliance and possibly result in a hazardous situation.

Individuals with PACEMAKERS should check with their doctor or the manufacturer of the pacemaker for precautions regarding microwave ovens.

To avoid the possibility of electric shock

Under no circumstances should you remove the outer cabinet.

Never spill or insert any objects into the door lock openings or ventilation openings. In the event of a spill, turn off and unplug the oven immediately and call your local Service Force Centre.

Do not immerse the power supply cord or plug in water or any other liquid.

Do not allow the power supply cord to run over any hot or sharp surfaces, such as the hot air vent area at the top rear of the oven.

Do not attempt to replace the oven lamp yourself or allow anyone who is not authorised by Service Force to do so. If the oven lamp fails, please consult your dealer or contact your local Service Force Centre.



Important safety instructions

If the power supply cord of this appliance is damaged, it must be replaced with a special cord. The exchange must be made by an authorised Service Force Centre.

To avoid the possibility of explosion and sudden boiling:

WARNING: Liquids and other foods must not be heated in sealed containers since they are liable to explode.

Never use sealed containers. Remove seals and lids before use. Sealed containers can explode due to a build up of pressure even after the oven has been turned off.

Take care when microwaving liquids. Use a wide-mouthed container to allow bubbles to escape.

Microwave heating of beverages can result in delayed eruptive boiling, therefore care has to be taken when handling the container.

To prevent sudden eruption of boiling liquid and possible scalding:

1. Stir liquid prior to heating/reheating.
2. It is advisable to insert a glass rod or similar utensil into the liquid whilst reheating.
3. Let liquid stand for at least 20 seconds in the oven at the end of cooking time to prevent delayed eruptive boiling.

Do not cook eggs in their shells, and whole hard boiled eggs should not be heated in microwave ovens since they may explode even after microwave cooking has ended. To cook or reheat eggs which have not been scrambled or mixed, pierce the yolks and the whites, or the eggs may explode. Shell and slice hard boiled eggs before reheating them in the microwave oven.

Pierce the skin of such foods as potatoes, sausages and fruit before cooking, or they may explode.

To avoid the possibility of burns

Use pot holders or oven gloves when removing food from the oven to prevent burns.

Always open containers, popcorn makers, oven cooking bags, etc., away from the face and hands to avoid steam burns.

To avoid burns, always test food temperature and stir before serving and pay special attention to the temperature of food and drink given to babies, children or the elderly.

Temperature of the container is not a true indication of the temperature of the food or drink; always check the food temperature.

Always stand back from the oven door when opening, to avoid burns from escaping steam and heat.

Slice stuffed baked foods after heating to release steam and avoid burns.

Keep children away from the door to prevent them burning themselves.

Do not touch the oven door, outer cabinet, rear cabinet, oven cavity, ventilation openings, accessories and dishes

during **GRILL** mode, **CONVECTION** mode, **DUAL** mode, **AUTO COOK** and **AUTO COOK FROM FROZEN**, operation as they will become hot. Before cleaning make sure they are not hot.

To avoid misuse by children

Warning: Only allow children to use the oven without supervision when adequate instructions have been given so that the child is able to use the oven in a safe way and understands the hazards of improper use.

Do not lean or swing on the oven door. Do not play with the oven or use it as a toy.

Children should be taught all important safety instructions: use of pot holders, careful removal of food coverings; paying special attention to packaging (e.g. self-heating materials) designed to make food crisp, as they may be extra hot.

Other warnings

Never modify the oven in any way.

Do not move the oven while it is in operation.

This oven is for home food preparation only and may only be used for cooking food. It is not suitable for commercial or laboratory use.

To promote trouble-free use of your oven and avoid damage.

Never operate the oven when it is empty except where recommended in the operation manual, see Page 11. Doing so may damage the oven.

When using a browning dish or self-heating material, always place a heat-resistant insulator such as a porcelain plate under it to prevent damage to the turntable due to heat stress. The preheating time specified in the dish's instructions must not be exceeded.

Do not use metal utensils, which reflect microwaves and may cause electrical arcing. Do not put cans in the oven.

Use only the turntable designed for this oven.

Do not place anything on the outer cabinet during operation.

Do not use plastic containers for microwaving if the oven is still hot from using the **GRILL** mode, **CONVECTION** mode, **DUAL** mode, **AUTO COOK**, and **AUTO COOK FROM FROZEN**, because they may melt. Plastic containers must not be used during above modes unless the container manufacturer says they are suitable.

NOTE:

If you are unsure how to connect your oven, please consult an authorised, qualified electrician.

Neither the manufacturer nor the dealer can accept any liability for damage to the oven or personal injury resulting from failure to observe the correct electrical connection procedure.

Water vapour or drops may occasionally form on the oven walls or around the door seals and sealing surfaces. This is a normal occurrence and is not an indication of microwave leakage or a malfunction.

Oven & accessories

- 1 Fixing points (4 points)
- 2 Grill heating element
- 3 Convection heating element
- 4 Oven lamp
- 5 Control panel
- 6 Shelf runners
- 7 Waveguide cover
- 8 Oven cavity
- 9 Coupling
- 10 Door seals and sealing surfaces
- 11 Door opening handle
- 12 Air-vent openings
- 13 Outer cabinet
- 14 Power cord
- 15 Power supply cord support clip

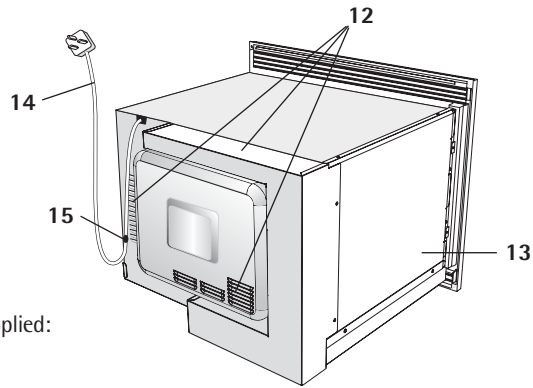
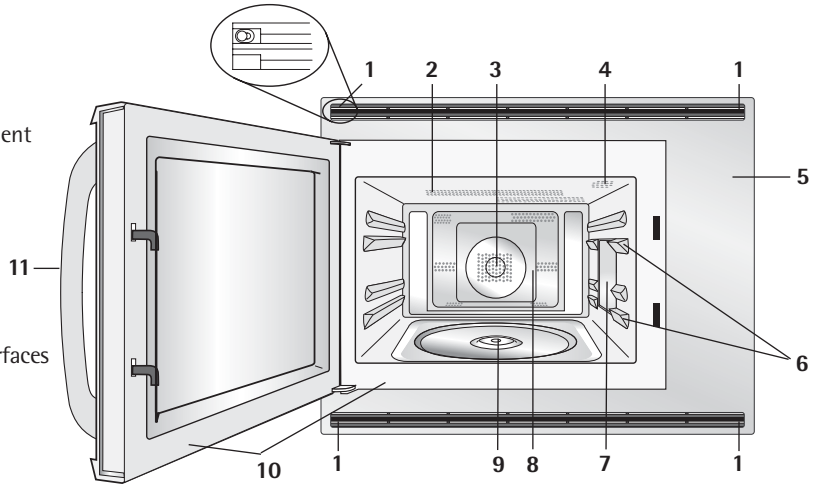

ACCESSORIES:

Check to make sure the following accessories are supplied:

- 16** Turntable **17** Turntable support **18** Low Rack
19 High rack **20** Rack for glass tray **21** Glass tray.

- Place the turntable support into the coupling in the centre of the oven floor, ensuring you place it TOP side up, (TOP is engraved on one side). It should be able to freely rotate around the coupling.
- Place the turntable on to the turntable support.
- Place the high/low racks onto the turntable if necessary
- Slide the glass tray into the shelf runners. You may cook dishes directly in the tray or set the rack inside the tray when roasting in order to catch drippings. (See page 20.)

NOTES:

- Always operate the oven with the turntable and support fitted correctly. This promotes thorough even cooking. A badly fitted turntable may rattle, may not rotate properly and damage the oven.
- The turntable rotates clockwise or counter clockwise. The rotary direction may change each time you start the oven. This does not affect cooking performance.
- When you order accessories, please mention two details: part name and model name to your dealer or Service Force Centre.

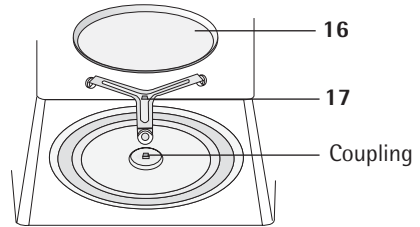

These racks are used for cooking in Convection, Dual or Grill mode.

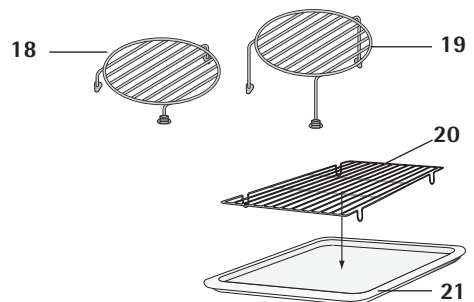

Control panel

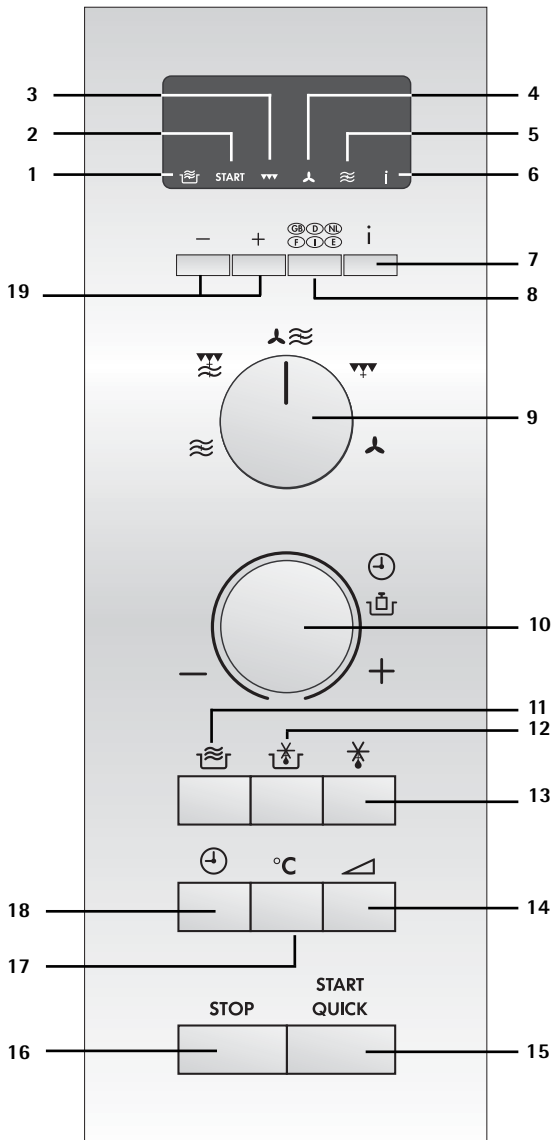

Digital display and indicators:

- 1 COOKING indicator
- 2 START indicator
- 3 GRILL indicator
- 4 CONVECTION indicator
- 5 MICROWAVE indicator
- 6 INFORMATION indicator

Operating buttons:

- 7 INFORMATION button
- 8 LANGUAGE button
- 9 COOKING MODE knob
 - ≡ for microwave cooking
 - ≡≡ for microwave cooking with GRILL
 - ≡≡≡ for microwave cooking with CONVECTION
 - ≡≡≡≡ for GRILL
 - ≡≡≡≡≡ for CONVECTION

- 10 TIMER/WEIGHT knob
Rotate the knob to enter either the cooking/defrosting time or weight of food.
- 11 AUTO COOK button
- 12 COOK FROM FROZEN button
- 13 AUTO DEFROST button
- 14 MICROWAVE POWER LEVEL button
- 15 START/QUICK button
- 16 STOP button
- 17 CONVECTION button
- 18 CLOCK SETTING button
- 19 LESS/MORE buttons

Before operation

Your oven has an energy save mode.

1. Plug in the oven. Nothing will appear on the display at this time.
2. Open the door.
The oven display will show "SELECT LANGUAGE" in 6 languages.

NOTE: Once you select the language using the **LANGUAGE** button, the display will show "**ENERGY SAVE MODE TO GO OUT OF ENERGY SAVE MODE SET CLOCK**" when you plug the oven in.

3. Close the door.
4. Select a language (See below).

NOTE: If you use the oven in English, you do not have to select language, simply press the **STOP** button.
The display will show "0" and go to step 5.

5. Set the clock (See page 7).
6. Heat the oven without food (See page 11).

COOKING HINTS:

The oven has an 'Information Display System' which offers you step by step instructions to easily guide you through each feature, and enable you to gain information in your desired language. The oven has an **INFORMATION** button for getting instructions for each button. Indicators will appear in the display, after pressing a button, to inform you of the next operation step.

Selecting the Language

Press LANGUAGE button	LANGUAGE
once	ENGLISH
twice	DEUTSCH
3 times	NEDERLANDS
4 times	FRANÇAIS
5 times	ITALIAN
6 times	ESPAÑOL

The oven comes set for English. You can change the language. To change, press the **LANGUAGE** button until the desired language is displayed. Then press the **START/QUICK** button.

Example:

To select **Italian**:

1. Choose the desired language by pressing the **LANGUAGE** button.

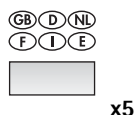

2. Press the **START/QUICK** button to start the setting.



Check the display.



NOTE: The selected language will be memorised even if the electrical power supply is interrupted.

Using the STOP button



Use the **STOP** button to:

1. Erase a mistake during programming.
2. Stop the oven temporarily during cooking.
3. Cancel a programme during cooking, press the **STOP** button twice.

Setting the clock

There are two setting modes: 12 hour clock and 24 hour clock.

Step 1

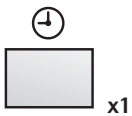

Step 2

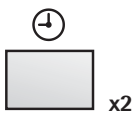

1. To set the 12 hour clock, press the **CLOCK SETTING** button once as in Step 1.
2. To set the 24 hour clock, press the **CLOCK SETTING** button twice as in Step 2.

Example:

To set the 24 hour clock to 23:35.

1. Choose the 24 hour clock by pressing the **CLOCK SETTING** button twice.
2. Set the hours. Rotate the **TIMER/WEIGHT** knob clockwise until the correct hour is displayed (23).
3. Change from hours to minutes by pressing the **CLOCK SETTING** button once.

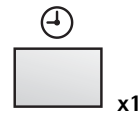
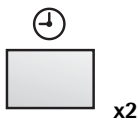

4. Set the minutes (35).

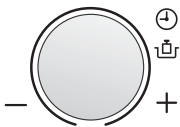

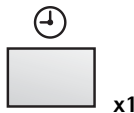

5. Press the **CLOCK SETTING** button to start the clock.



Check the display.



NOTES:

1. You can rotate the **TIMER/WEIGHT** knob clockwise or counterclockwise.
2. Press the **STOP** button if you make a mistake during programming.
3. If the oven is in cooking mode and you wish to know the time of day, touch the **CLOCK SETTING** button. As long as your finger is touching the button, the time of day will be displayed.
4. If the electrical power supply to your microwave oven is interrupted, plug in the oven again, then open and close the door. The display will show "ENERGY SAVE MODE TO GO OUT OF ENERGY SAVE MODE SET CLOCK". This information will appear if you have already set the language with the **LANGUAGE** button. If this occurs during cooking, the programme will be erased. The time of day will also be erased.
5. When you want to reset the time of day, follow the above example again.
6. If you do not set the clock, press the **STOP** button once.  will appear on the display. When the operation of the oven is finished,  will reappear on the display instead of the time of day.
7. If you set the clock, energy save mode does not work.

Energy save mode

Your oven comes set for the energy save mode.

If you do nothing for 3 minutes after a preceding operation, i.e. closing the door or at the end of cooking, the power will go off automatically. To restore power on, open the door.

To start energy save mode, follow the instructions below.

Example:

To start the energy save mode, (the current time is 23:35):

1. Make sure the correct time appears on the display.
2. Press the **CLOCK SETTING** button once.
3. Adjust the display to 0 by rotating the **TIMER/WEIGHT** knob.
4. Press **START/QUICK** button. The power will be off and the display will show nothing.

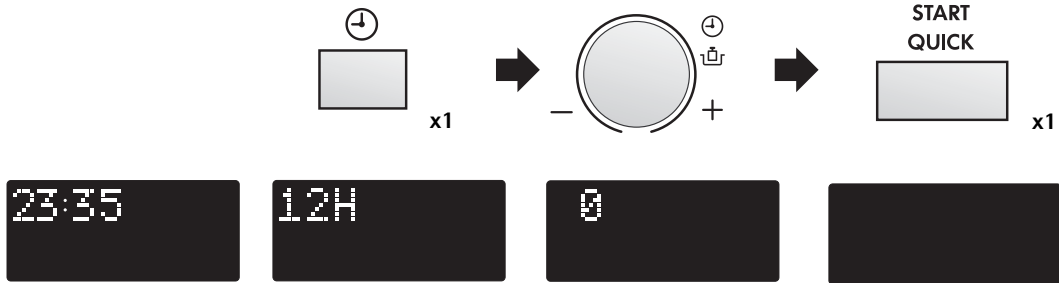

NOTE: You can press the **CLOCK SETTING** button twice at step 2.

Microwave power levels

Your oven has 5 power levels. To choose the power level for cooking, follow the advice given in the recipe section. Generally the following recommendations apply:

900 W used for fast cooking or reheating e.g. soup, casseroles, canned food, hot beverages, vegetables, fish, etc.

630 W used for longer cooking of dense foods such as roast joints, meat loaf and plated meals, also for sensitive dishes such as cheese sauce and sponge cakes. At this reduced setting, the sauce will not boil over and food will cook evenly without over cooking at the sides.

450 W for dense foods which require a long cooking time when cooked conventionally, eg. beef dishes, it is advisable to use this power setting to ensure the meat will be tender.

270 W (Defrost setting) to defrost, select this power setting, to ensure that the dish defrosts evenly. This setting is also ideal for simmering rice, pasta, dumplings and cooking egg custard.

90 W for gentle defrosting, eg. cream gateaux or pastry.

W = WATT

To set the microwave power level :

1. Rotate the **COOKING MODE** dial to the microwave setting.
2. Rotate the **TIMER/WEIGHT** knob clockwise or counter-clockwise to select cooking time.
3. Press the **MICROWAVE POWER LEVEL** button until the desired power level appears on the display. (If the **MICROWAVE POWER LEVEL** button is touched once, **900 W** will be displayed. If you miss your desired level, continue pressing the **MICROWAVE POWER LEVEL** button until you reach the level again).
4. Press the **START/QUICK** button.

NOTE: If the power level is not selected, 900 W is automatically set.

i What are microwaves?

Like radio and television waves, microwaves are electromagnetic waves.

Microwaves are produced by a magnetron inside the microwave oven, and these vibrate the molecules of water present in the food. The friction this causes produces heat, which ensures that the food is defrosted, heated or cooked through.

The secret of the reduced cooking times is the fact that the microwaves penetrate the food from every direction. Energy is used to the full. In comparison, the energy from a conventional hob passes from the burner through the pan and so to the food.

This method wastes a great deal of energy.

THE CHARACTERISTICS OF MICROWAVES

Microwaves penetrate all non-metal objects made of glass, china, earthenware, plastic, wood or paper. This is why the microwaves never make these materials hot. Dishes become hot only because the food inside them is hot.

The food absorbs the microwaves and is heated.

Microwaves cannot pass through objects made of metal and so they are deflected. For this reason metal objects are not normally suitable for microwave cookery.

There are exceptions where you can actually make use of the fact that the microwaves cannot pass through metal. If you cover food with aluminium foil at specific points while it is defrosting or cooking, you can prevent those parts from getting too warm, too hot, or overcooked. Please check out the advice given in the guide.

i This is what your new combination microwave oven can do

Microwave operation

By using the microwave facility in your new combination microwave oven you can, for example, quickly heat up ready-prepared meals or drinks, or melt butter or chocolate in no time at all.

The microwave oven is equally good at defrosting food. Sometimes, however, it is better to combine the microwave with convection heating or grilling (combined operation). You can then cook the food rapidly and brown it at the same time. Cooking times are generally much shorter than in conventional food preparation.

COMBINED OPERATION (MICROWAVE OPERATION WITH CONVECTION OR GRILL)

By combining two modes of operation the benefits of your oven are cleverly linked together.

You are able to choose between

- microwave + convection (ideal for joints of meat, poultry, puddings, bread and cakes) and
- microwave + grill (ideal for pizzas, snacks, quick fry-ups, joints, poultry, chicken legs, kebabs, Welsh rarebit and cooking au gratin).

Using the combination facility you can cook and brown food at the same time.

The advantage is that the convected heat or the heat from the grill quickly seals the pores in the outer layers of the food. The microwaves ensure a short and gentle cooking period. The juices are preserved inside the food and the outside is crisp.

Convection operation

You can also use convection without microwave. The result is like using a conventional oven. The circulating air quickly heats up the external parts of the food without drying up the meat juices and the foods.

This sealing process means that the meals remain tasty and cook in a shorter time than with conventional ovens with upper and lower heaters.

Grill Operation

This appliance comes with a quartz grill above the cooking area. It can be used as a conventional grill without microwave. You can quickly bake or grill dishes. It's also suitable for steaks, chops and cakes.

Microwave cooking

Your oven can be programmed for up to 90 minutes. (90.00). The input unit of cooking (defrosting) time varies from 10 seconds to five minutes. It depends on the total length of the cooking (defrosting) time as shown in the table opposite:

Cooking Time:	Increasing unit:
0-5 minutes	10 seconds
5-10 minutes	30 seconds
10-30 minutes	1 minute
30-90 minutes	5 minutes

Example:

To heat soup for 2 minutes and 30 seconds on 630 W microwave power.

1. Rotate the **COOKING MODE** dial to the  MICROWAVE setting.
2. Enter desired cooking time by rotating the **TIMER/WEIGHT** knob clockwise.
3. Press the **MICROWAVE POWER LEVEL** button twice for 630 W microwave power.
4. Press the **START/QUICK** button once to start cooking.

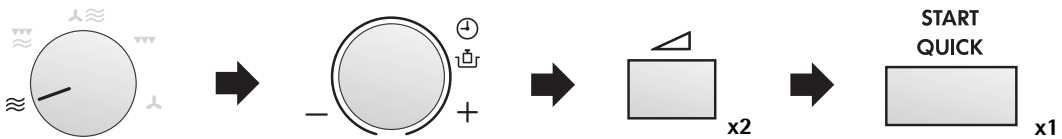

Check the display.



NOTES:

1. When the door is opened during the cooking process, the cooking time on the digital display stops automatically. The cooking time starts to count down again when the door is closed and the **START/QUICK** button is pressed.
2. If you wish to know the power level during cooking, press the **MICROWAVE POWER LEVEL** button. As long as your finger is pressing the **MICROWAVE POWER LEVEL** button, the power level will be displayed.
3. You can rotate the **TIMER/WEIGHT** knob clockwise or counter-clockwise. If you rotate the dial counter-clockwise, the cooking time will decrease from 90 minutes by degrees.

Grill cooking

The grill heating element at the top of the oven cavity has one power setting only.

Example: To cook cheese on toast for 5 minutes (Place toast on the high rack.)

1. Rotate the **COOKING MODE** dial to the  GRILL setting.
2. Enter the desired cooking time by rotating the **TIMER/WEIGHT** knob clockwise.
3. Press the **START/QUICK** button to start cooking.

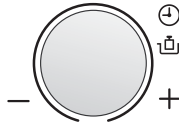
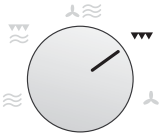

Check the display.



1. The high or low racks are recommended when grilling.
2. You may detect smoke or a burning smell when using the grill for the first time, this is normal and not a sign that the oven is out of order. (Please see heating without food below.)
3. After cooking the display may show 'NOW COOLING'.



WARNING: The oven cavity, door, outer cabinet, turntable, racks and dishes will become very hot, always use thick oven gloves when removing the food or turntable from the oven to prevent burns.

Heating without food

You may detect smoke or a burning smell when using the grill and convection for the first time. This is normal and not a sign that the oven is out of order.

To avoid this problem, when first using the oven, heat the oven without food for 20 minutes on grill and then at convection 250°C.

IMPORTANT: During operation, to allow smoke or smells to disperse open a window or switch the kitchen ventilation on. Make sure there is no food in the oven.

1. Rotate the **COOKING MODE** dial to the  GRILL or  CONVECTION setting.
2. Enter the required heating time. (20 min.)
3. Start cooking by pressing the **START/QUICK** button.

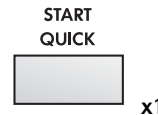

The oven will count down. When the oven has finished cooking, open the door to cool the oven cavity.

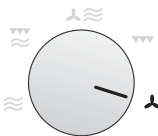

WARNING:

The oven door, outer cabinet & oven cavity will become hot. Take care to avoid burns when the oven is cooling down after operation.

Convection cooking

Your oven can be used as a conventional oven using the convection facility and 10 pre-set oven temperatures.

Press Convection button	1	2	3	4	5	6	7	8	9	10
Oven Temp (°C)	250	230	220	200	190	180	160	130	100	40

Example 1: To cook with preheating

To pre-heat to 180°C and cook for 20 minutes at 180°C.

1. Select the cooking mode by rotating the cooking mode dial to .

2. Enter the desired preheat temperature by pressing the **CONVECTION** button six times. The display will show 180°C.

3. Press the **START/QUICK** button to start pre-heating.

When the pre-heated temperature has been reached the audible signal sounds, the display will show 180°C, open the door and place the food inside the oven. Close the door.

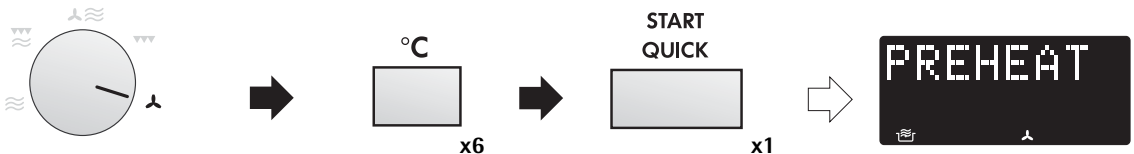

4. Use the **TIMER/WEIGHT** knob to input the cooking time (20 mins).

5. Press the **START/QUICK** button.

Check the display.



NOTES:

1. When the oven is preheating, the turntable should be in the oven.
2. After preheating, if you want to cook at a different temperature press the **CONVECTION** button until the desired setting appears on the display. In the example above, to change the temperature you would press the **CONVECTION** button after entering the cooking time.
3. When the oven reaches the programmed preheating temperature, it will automatically hold at the pre-heated temperature for 30 minutes. After 30 minutes the display will change to time of day, if set. The selected convection programme will be cancelled.
4. After cooking the oven will automatically cool and the display may show "NOW COOLING".
5. To get the best results when following pack instructions for convection, please follow the instructions for "conventional oven".

Convection cooking

Example 2: To cook without preheating

To cook at 250°C for 20 minutes.

1. Select the cooking mode by rotating the cooking mode dial to .
2. Use the **TIMER/WEIGHT** knob to input the cooking time (20 mins).
3. Select the desired cooking temperature. (250°C.)
4. Press the **START/ QUICK** button.

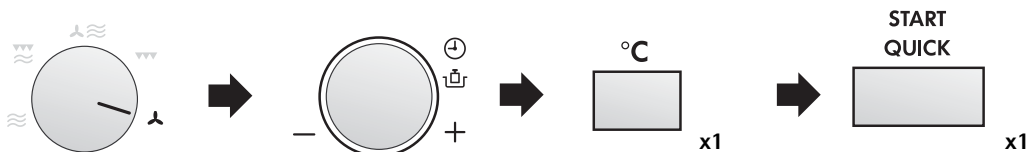

Check the display.





NOTES:

1. After cooking the oven will automatically cool and the display may show **"NOW COOLING"**.
2. To change the convection temperature, press the **CONVECTION** button until the desired temperature appears on the display.
3. You may detect smoke or a burning smell when using convection for the first time. This is normal and is not a sign that the oven is out of order. (Please see Heating Without Food on page 11).



WARNING: The oven cavity, door, outer cabinet, turntable, racks and dishes will become very hot, always use thick oven gloves when removing the food or turntable from the oven to prevent burns.

Dual cooking

Your oven has 2 **DUAL** cooking modes combining 1) Convection & microwave, 2) Grill with microwave. To select the **DUAL** cooking mode rotate the **COOKING MODE** dial to the desired setting, then choose the cooking time. Generally, dual cooking time shortens the total cooking time.

COOKING MODE	Cooking method	Initial microwave power
DUAL 1 	Convection 250°C	270 W
DUAL 2 	Grill	270 W

NOTES: The power settings are variable:

- DUAL 1  : The oven temperature can be changed from 40°C to 250°C in ten levels.
Microwave power levels can be changed from 90 W - 630 W in four levels.
- DUAL 2  : Microwave power levels can be changed from 90 W - 900 W in five levels.

Example 1:

To cook for 20 minutes on DUAL 1 using 90 W microwave power and 200°C convection.

1. Select the cooking mode by rotating the cooking mode dial to .
2. Enter the desired cooking time (20 minutes).
3. Press the microwave **POWER LEVEL** button twice (90 W).

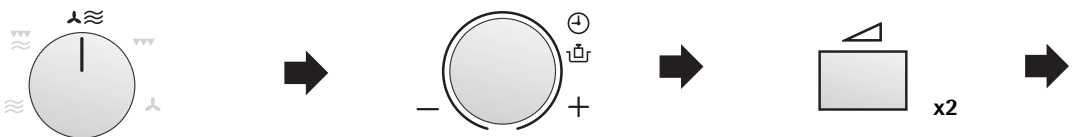

4. Press **CONVECTION** button four times (200°C).
5. Press the **START/QUICK** button.

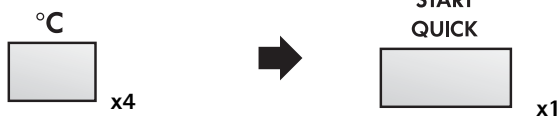

Check the display.

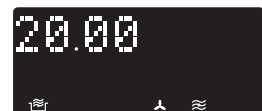

Dual cooking

Example 2:

To cook for 20 minutes on DUAL 2 using 90 W microwave power and GRILL.

1. Select the cooking mode by rotating the cooking mode dial to .



2. Enter the desired cooking time (20 minutes).



3. Press the **MICROWAVE POWER LEVEL** button twice (90 W).

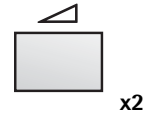

4. Press the **START/QUICK** button.



Check the display.



NOTE: After cooking, the oven will automatically cool and the display may show "NOW COOLING".

WARNING: The oven cavity, door, outer cabinet, turntable, racks and dishes will become very hot, always use thick oven gloves when removing the food or turntable from the oven to prevent burns.

Other convenient functions

1. LESS (▼) / MORE (▲) button

The **LESS (▼)** and **MORE (▲)** buttons allow you to decrease or increase programmed setting times easily, (for a less well or more well cooked result), when cooking in progress.

a) Choosing Autocook with Less/More:

Press the **LESS (▼)** and **MORE (▲)** button after entering weight and before pressing the **START/QUICK** button. (See cooking for menus that use Less and More.)

Example: To cook 0,2 kg French Fried Potatoes using the **AUTO COOK FROM FROZEN**.

1. Choose the **AUTO COOK FROM FROZEN** menu for French Fried Potatoes by pressing the button four times.

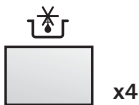

2. Enter the amount (0,2 kg).



3. Choose the "thin" French Fried Potatoes by pressing the **LESS (▼)** button once.

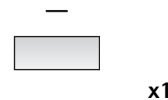

4. Press the **START/QUICK** button.

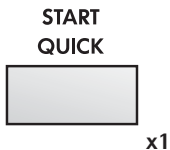

Check the display.



NOTES:

- To cancel less or more press the same button again.
- To change more to less simply press the less (▼) button.
- To change **LESS** to **MORE** simply press the **MORE (▲)** button.

b) Changing the heating time while the oven is operating:

During the manual cooking process, the cooking time can be decreased or increased in 1 minute steps each time the **LESS (▼)** and **MORE (▲)** buttons are pressed.

NOTE: You can use this function for manual cooking only.

Other convenient functions

2. START/QUICK FUNCTION

The **START/QUICK** button allows you to operate the two following functions:

a) 30 seconds cooking

You can cook on your desired cooking mode for 30 seconds without entering the cooking time.

Example:



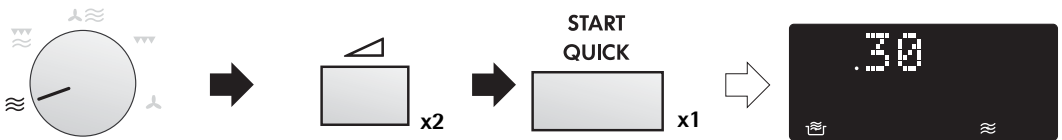

To cook for 30 seconds on 630 W microwave power.

1. Select the cooking mode by rotating the **COOKING MODE** dial to  (Microwave).
2. Change the power by pressing the **MICROWAVE POWER LEVEL** button.
3. Press the **START/QUICK** button once to begin cooking.



Check the display.

NOTES:

1. You can use this function for manual cooking only.
2. When the **COOKING MODE** dial is on microwave () and you press the **START/QUICK** button, the microwave power is always 900 W.
When the **COOKING MODE** dial is on dual ( or ) and you press the **START/QUICK** button, the microwave power is always 270 W.
When the **COOKING MODE** dial is on convection or dual 1 ( or ) and you press the **START/QUICK** button, the convection temperature is always 250°C.
3. To avoid misuse by children the add 30 seconds function can be used only within 3 minutes after the preceding operation, ie closing the door, pressing the **STOP** button or end of cooking.

b) Extend the cooking time

You can extend the cooking time in multiples of 30 seconds if the **START/QUICK** button is pressed while the oven is in operation.

NOTE: You can use this function for manual cooking only.

Other convenient functions

3. TO CHECK SETTINGS WHILE THE OVEN IS OPERATING

You can check the power level and the actual oven temperatures ie: when pre-heating.

TO CHECK THE POWER LEVEL:

To check the microwave power level during cooking press the **MICROWAVE POWER LEVEL** button. The oven continues to count down, although the display shows the power level.

As long as your finger is pressing the  button, the power level will be displayed.



TO CHECK THE CONVECTION TEMPERATURE:

To check the convection temperature during cooking press the **CONVECTION** button. When the oven is pre-heating, you can check the actual oven temperature.

As long as your finger is pressing the  button, the convection temperature in °C will be displayed.

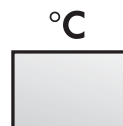

4. INFORMATION button

Each button carries useful information. If you wish to get the information, press the **INFORMATION** button before pressing the desired button.

Example:

To get information about AUTO COOK menu number 2, Roast chicken:

NOTE:

1. The information message will be repeated twice, and then the display will show the time of day, if set.
2. If you want to cancel the information press the **STOP** button.

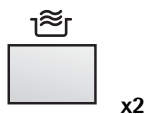

1. Choose the **INFORMATION** button function.
2. Press the **AUTO COOK** button 2 times to select Roast Chicken.



Suitable ovenware

Ovenware material	Mode of operation			
	Micro-wave	Convec-tion	Grill	Combination
Ovenproof glass and ceramic dishes (without any metal parts, e.g. Pyrex, oven-to-tableware, glass tray).	X	X	X	X
Non ovenproof glass and porcelain (e.g table crockery ¹⁾ .	X	-	-	-
Glass ceramic and vitroceramic made of fire / frostproof material (e.g. Arcoflam).	X	X	X	X
Ovenproof earthenware ²⁾ .	X	X	-	X
Plastic heat-resistant up to 200°C ³⁾ .	X	X ³⁾	-	X ³⁾
Paper, cardboard	X	-	-	-
Cling film	X	-	-	-
Microwaveable roasting bag ⁴⁾ .	X	X	-	X ⁴⁾
Metal roasting pans, e.g. enamel or cast-iron dishes.	-	X	X	-
Black-lacqued or silicone-coated baking tins.	-	X	-	-

X = suitable - = non suitable

- 1). excluding silver, gold, platinum or metal decoration
- 2). does not include glaze containing metal
- 3). please note the maximum temperature stated by the manufacturer
- 4). convection + microwave combined function

Cooking charts

BAKING USING THE GLASS TRAY WITH THE CONVECTION FUNCTION

MENU	TIME	MODE	POSITION
Quiche	Preheat	200°C	Cook base for 15'00, directly in glass tray, lower position, rotate after 1)
	1) 20'00	200°C	
	2) 12'00	200°C	
Banana Loaf Cake	Preheat	180°C	Place loaf tin in glass tray, lower position
	60'00	180°C	
Apricot & Pecan Loaf	Preheat	180°C	Place loaf tin in glass tray, lower position
	35'00	90 W & 180°C	
Cherry & Almond Cake	Preheat	180°C	Place loaf tin in glass tray, lower position
	40'00	90 W & 180°C	
Cheese Cake	Preheat	160°C	Place on the rack in glass tray, lower position
	54'00	160°C	
Frozen Pizza	Preheat	220°C	Place on the rack in glass tray, lower position
	12'00	220°C	
Garlic Baguette	Preheat	200°C	Place directly in glass tray, lower position
	15'00	90 W & 200°C	
Frozen Lasagne	Preheat	200°C	Place directly in glass tray, lower position
	25'00	270 W & 200°C	
Small Pastries (from dough) (e.g. Croissants)	Preheat	160°C	Place directly in glass tray lower position
	35'00	160°C	

USING THE GLASS TRAY WITH THE GRILL FUNCTION

MENU	TIME	MODE	POSITION
Gratin	1) 6'00	900 W	Place dish in glass tray, lower position Rotate after 2)
	2) 14'00	450 W & grill	
	3) 5'00	450 W & grill	
Kebabs	1) 10'00	270 W & grill	Place on the rack in glass tray, upper position
	2) 10'00	270 W & grill	
Onion Soup	1) 8'00	900 W	Place the soup bowls into the glass tray, lower position, add cheese & croutons after 1).
	2) 7'30	270 W & grill	
Chicken Noodle Casserole	1) 3'00	900 W	Place dish in glass tray, lower position
	2) 10'00	450 W & grill	
Steak	1) 9'00	Grill	Place on the rack in glass tray, lower position
	2) 4'00	Grill	
Thick sausages	1) 14'00	Grill	Place on the rack in glass tray, lower position Turnover after 1)
	2) 5'00	Grill	
Thin sausages	1) 12'00	Grill	Place on the rack in glass tray, lower position Turnover after 1)
	2) 6'00	Grill	
Toast	1) 4'30	Grill	Place on the rack in glass tray, lower position Turnover after 1).
	2) 1'30	Grill	
Cheese on Toast	1) Preheat 2'00	Grill	Place on the rack in glass tray, lower position turn over and add cheese after 2).
	2) 5'00	Grill	
	3) 4'30	Grill	
Mackerel	1) 6'00	90 W & Grill	Place on the rack in glass tray, lower position Turnover after 1).
	2) 6'00	90 W & Grill	
Sardines	1) 5'00	90 W & Grill	Place on the rack in glass tray, lower position Turnover after 1).
	2) 3'00	90 W & Grill	



The above information should be used as a guideline.

Adjust cooking times/power levels as required to give the best result



The times given are for guidance only, as they are dependent upon the type and quality of the meat.

Grilling is ideal for flat, pieces of meat and fish.

Unless otherwise stated, the settings given in the table are for use in a cold oven.

Flat foods should be turned only once. Thicker pieces should be turned more often.

Fish are best placed head to tail on the wire tray.

Recipes for glass tray & convection

Banana loaf

Ingredients

120 g	butter
170 g	caster sugar
1 tsp	coffee essence
2	ripe bananas
225 g	flour
1 tsp	bicarbonate of soda
1/4 tsp	baking powder
1	medium egg
100 ml	milk

Preheat the oven.

1. Grease and line loaf tin.
2. Cream butter and sugar together.
3. Add egg and coffee essence and beat again.
4. Peel and mash bananas and add to the mix, beat well.
5. Mix in the flour, bicarbonate of soda baking powder and milk until smooth.
6. Place in tin and smooth the surface.
7. Place loaf tin in glass tray, lower position.
60 min. ▲ 180°C
8. Stand for 5 mins in tin before turning onto a cooling rack.

Apricot & pecan loaf

Ingredients

	pinch of salt
1 1/2 tsp	baking powder
2 tsp	cinnamon
110 g	plain flour
110 g	wholemeal flour
110 g	butter
175 g	soft brown sugar
2	beaten eggs
3 tbsp	milk
175 g	ready to eat apricots, chopped
175 g	toasted pecans, chopped

Preheat the oven.

1. Grease and line loaf tin.
2. Mix the salt, baking powder, cinnamon and flour.
3. Add the rest of the ingredients, except the fruit and nuts, mix well.
4. Fold in the fruit and nuts.
5. Place in tin and smooth the surface.
6. Place loaf tin in glass tray, lower position.
35 min. ▲ ≈ 90 W / 180°C

Baked cheesecake

Ingredients

Base:

100 g	butter
4 tsp	brown sugar
200 g	plain flour
110 g	crushed digestive biscuits

Filling:

450 g	soft cheese
150 g	double cream
100 g	caster sugar
2	egg yolk
1	juice and zest of lemon

1. Line the base of the springform tin with greaseproof paper.
2. Melt the butter, add the sugar and crushed biscuits.
3. Push into base of the tin, then chill until set.
4. Put all the filling ingredients in a bowl and whisk until smooth.
5. Pour the filling onto the chilled base.
6. Place tin in glass tray, lower position.
54 min. ▲ 160°C
7. Allow to cool, decorate with fruit to serve.

Recipes for glass tray & convection

Cherry almond cake

Ingredients

175 g	margarine
175 g	caster sugar
3	medium eggs
175 g	plain flour
1 tsp	baking powder
100 g	glace cherries
75 g	ground almonds
1 tsp	almond essence
1 tbsp	milk

1. Grease and line the springform.
2. Cream the margarine and sugar until light and fluffy.
3. Beat in the eggs one at a time.
4. Fold in the flour and baking powder, stir in the cherries, ground almonds, almond essence and milk.
5. Spoon in the mixture and smooth the surface.
6. Place tin in glass tray, lower position.

40 min. ⤴ ≈ **90 W / 180°C**

Red onion quiche

Ingredients

500 g	shotcrust pastry
45 g	butter
300 g	red onions, sliced
3	eggs
150 ml	double cream
50 ml	milk
100 g	grated gouda
1/4 tsp	dijon mustard
	black pepper
1/4 tsp	salt

Preheat the oven.

1. Roll out the pastry and line the square dish.
 2. Prick the pastry all over with a fork.
 3. Line the pastry with baking paper.
 4. Bake in lower position
- 15 min.** ⤴ **200°C**
5. Remove from the oven and allow to cool.
 6. Cook the onions in the butter for

5 min. ≈ **900 W**

drain off the butter then cool.

7. Beat the eggs, cream, milk, mustard, salt and pepper together.
8. Add the onions and cheese, mix well.
9. Pour mixture into the pastry case and cook.

1. **20 min.** ⤴ **200°C**, rotate, then

2. **12 min.** ⤴ **200°C**

Recipes for glass tray & grill

Onion soup

Ingredients

20 g	butter
250 g	onions
500 ml	stock
	salt & pepper
2	slices of toast
80 g	emmental cheese

1. Slice the onions, place in a bowl with the stock, salt and pepper, cook for
8 min. ≈ **900 W**
2. Put the soup in to 4 soup bowls.
3. Cut the toast into cubes and put on top of the soup and place the cheese on the toast.
4. Place soup bowls in the glass tray, lower position and cook
7 1/2 min. ≈ **270 W / GRILL**

Gratin

Ingredients

450 g	potatoes, sliced thinly
150 g	sliced onion,
200 g	grated gouda
	salt & pepper
250 ml	cream
3	eggs

1. Grease a gratin dish.
2. Put a layer of potatoes, a layer of onions and 1/2 the cheese in to the dish.
3. Repeat, finishing with a top layer of potato.
4. Mix together cream and eggs, add salt & pepper. Pour over the potatoes.
5. Sprinkle the remaining cheese over the top.
6. Place dish in the glass tray, lower position, cook
 1. **6 min.** ≈ **900 W**
 2. **14 min.** ≈ **450 W / GRILL**, rotate, then
 3. **5 min.** ≈ **450 W / GRILL**

Chicken noodle casserole

Ingredients

30 g	butter
100 g	sliced mushrooms
100 g	diced onion
100 g	diced peppers
25 g	plain flour
175 ml	milk
300 ml	stock
150 g	sweetcorn
	salt & black pepper
250 g	diced, cooked chicken
150 g	cooked noodles
75 g	freshly grated gouda cheese

1. Place butter, onion, pepper and mushroom in a bowl and cook
2 min. ≈ **900 W**
2. Blend the flour with the milk until smooth, add the stock, sweetcorn, salt & pepper, mix well.
3. Add the chicken and noodles to the sauce.
4. Sprinkle the cheese over the top.
5. Place dish in the glass tray, lower position, cook
 1. **3 min.** ≈ **900 W**
 2. **10 min.** ≈ **450 W / GRILL**

Grilled sardines/mackerel

Ingredients

6	headless sardines/mackerel
Marinade	
4 tbs	olive oil
1 tsp	garlic puree
1 tbsp	balsamic vinegar
1 tsp	lemon juice
	salt & pepper
1 tsp	fennel

1. Mix all ingredients for marinade and spread on the fish, chill for one hour.
2. Place on the rack in the glass tray, lower position.
Cook Sardines:
 1. **5 min.** ≈ **90 W / GRILL** turnover
 2. **3 min.** ≈ **90 W / GRILL**Cook Mackerel
 1. **6 min.** ≈ **90 W / GRILL**, turnover
 2. **6 min.** ≈ **90 W / GRILL**

Automatic operations

The **AUTOMATIC OPERATIONS** automatically work out the correct cooking mode and cooking time. You can choose from 5 **AUTO COOK** menus, 4 **AUTO COOK FROM FROZEN** menus and 7 **AUTO DEFROST** menus.

Warning:

For **AUTO COOK** and **AUTO COOK FROM FROZEN**:

The oven cavity, door, outer cabinet, turntable, racks and dishes will become very hot. Use thick oven gloves when removing food or the turntable from the oven to prevent burns.

What you need to know when using this automatic function:

1. Enter the menu by pressing the **AUTO COOK**, **AUTO COOK FROM FROZEN** or **AUTO DEFROST** button until the desired menu number appears in the display. (See pages 26-28)
2. The weight or quantity of the food can be input by rotating the **TIMER/WEIGHT** knob until the desired weight/quantity is displayed.
 - Enter the weight of the food only. Do not include the weight of the container.
 - For food weighing more or less than weights/quantities given in the cooking chart, cook using manual programmes.
3. The programmed cooking times are average times. If you want to alter cooking times pre-programmed in the automatic operations, use the **LESS (▼)** or **MORE (▲)** buttons. See page 16 for details. For best results, follow cooking chart instructions.
4. To start cooking press **START/QUICK** button.

When action is required (e.g. to turn food over) the oven stops and the audible signals sound, the display shows the necessary action. To continue cooking, press the **START/QUICK** button.

The final temperature will vary according to the initial temperature. Check food is piping hot after cooking. If necessary, you can extend the cooking time and change the power level.

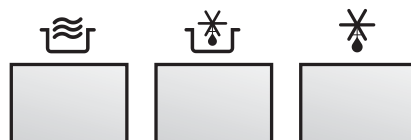

AUTOMATIC buttons

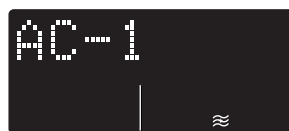
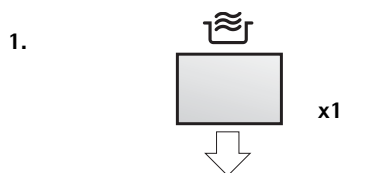

Menu Number

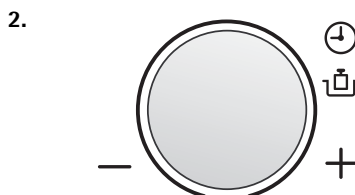

TIMER/WEIGHT knob



LESS/MORE buttons



START/QUICK button

NOTE: Please refer to the menu label for list of AUTOMATIC menus and weight ranges.



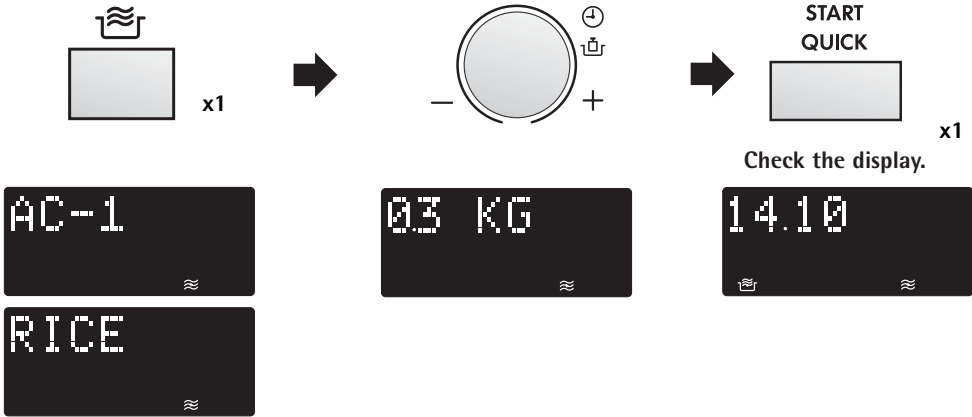

Automatic operations

Example: To cook 300 g of Rice using AUTO COOK (AC-1)





1. Press the **AUTO COOK** button once to select Rice.
2. Enter the weight by rotating the **TIMER/WEIGHT** knob until the desired weight is displayed.
3. Press the **START/QUICK** button to start cooking.









Auto cook chart

MENU NO.	WEIGHT (Increasing Unit) / UTENSILS	PROCEDURE						
AC-1  Rice (par-boiled) (initial temp rice 20°C)	0,1 - 0,3 kg (100 g) Big bowl & lid	<ul style="list-style-type: none"> Place in a big bowl and add boiling water. Cover with a lid. Place the dish in the centre of the turntable. When the audible signals sound, stir and recover. When the audible signals sound again, stir and recover, replace into the oven and press start. Stand for approx. 10 mins after cooking. 						
	<table border="1"> <thead> <tr> <th>Rice</th> <th>Boiling Water</th> </tr> </thead> <tbody> <tr> <td>100 g</td> <td>250 ml</td> </tr> <tr> <td>200 g</td> <td>450 ml</td> </tr> <tr> <td>300 g</td> <td>650 ml</td> </tr> </tbody> </table>		Rice	Boiling Water	100 g	250 ml	200 g	450 ml
Rice	Boiling Water							
100 g	250 ml							
200 g	450 ml							
300 g	650 ml							
AC-2  Roast Chicken (initial temp 5°C) Ingredients for 1,2 kg Roast chicken: Salt and Pepper, 1 tsp sweet paprika, 2 tbsp oil	0,9 - 2,0 kg (100 g) Low Rack	<ul style="list-style-type: none"> Mix the ingredients and spread on the chicken. Pierce the skin of the chicken. Put chicken breast side down on the low rack. When audible signals sound, turn the chicken over. After cooking, let the food stand for 3 minutes in the oven. 						
AC-3  Roast Pork (initial temp 5°C) Ingredients for 1 kg rolled lean pork: 1 garlic clove, crushed, 2 tbsp oil, 1 tbsp sweet paprika, a little cumin powder, 1 tsp salt	0,6 - 2,0 kg (100 g) Low Rack	<ul style="list-style-type: none"> Lean roast pork is recommended. Mix all ingredients and spread them onto the pork. Place the pork on the low rack and cook. When audible signals sound, turn the food over. After cooking, let the food stand wrapped in aluminium foil for approx. 10 minutes. 						
AC-4  Gratin (initial temp 20°C) e.g. Courgette pasta gratin and Broccoli-Mushroom-Potato gratin	0,5 - 2,0 kg (100 g) Shallow, oval or round gratin dish Low Rack	<ul style="list-style-type: none"> Prepare the gratin referring to the page 23. Place the gratin dish on the low rack. After cooking, let the food stand covered for approx. 5-10 minutes. 						
AC-5  Cake (initial temp 20°C) e.g. Carrot cake, Gugelhupf, Apple cake with Calvados	0,5 - 1,5 kg (100 g) Baking tin, Saucer Low rack	<ul style="list-style-type: none"> Prepare the cake referring to pages 31-32. Put a saucer upside down on the low rack and place the baking tin on it. Let the cake stand for approximately 10 minutes after baking. Remove the cake from the baking tin. 						

Auto cook from frozen chart

MENU NO.	WEIGHT (Increasing Unit) / UTENSILS	PROCEDURE
ACF-1 Cook  Frozen Ready Meals (initial temp -18°C) Stirrable type (e.g. Noodles Bolognese, Chinese Menus.)	0,3 - 1,0 kg* (100 g) Casserole dish & lid * If the manufacturer instructs to add water, please calculate the total amount for the program with additional liquid.	<ul style="list-style-type: none"> • Transfer meal to suitable casserole dish. • Add some liquid if recommended by the manufacturer. • Cover with a lid. • When the audible signals sound, stir and re-cover. • After cooking, stir and let stand for approx. 1-2 minutes.
ACF-2 Cook  Frozen Vegetables (initial temp -18°C) e.g. Brussel sprouts, cauliflower, peas, mixed vegetables, broccoli	0,1 - 0,8 kg (100 g) Casserole dish & lid	<ul style="list-style-type: none"> • Add 1tbsp water per 100 g. (For mushrooms no additional water is necessary). • Cover with a lid. • When the oven stops and the audible signals sound, stir and re-cover. • After cooking, let stand for approx. 1-2 minutes. <p>NOTE: If frozen vegetables are compacted together, cook manually.</p>
ACF-3 Cook  Frozen Gratin (initial temp -18°C) e.g. Frozen lasagne, Potato gratin	0,2 - 0,6 kg (100 g) Gratin dish Low rack	<ul style="list-style-type: none"> • Remove the gratin from original container and place in a suitable gratin dish. • Add 3-4 tbsp water if necessary. • Do not cover. • Place on the low rack. • After cooking, let stand, covered in aluminium foil for approximately 5 minutes.
ACF-4 Cook  Frozen French Fried Potato (recommended for conventional ovens) (initial temp -18°C)	0,20 - 0,40 kg (50 g) Flan Dish High Rack	<ul style="list-style-type: none"> • Remove the frozen french fried potatoes from the package and place them on a flan dish. • Place the dish on the high rack in the oven. • When the audible signals sound, turn over. • After cooking, remove from the dish and put on a plate for serving. (No standing time is necessary). • Add salt to taste. <p>NOTE: For thin type of French fried potatoes, cook with the LESS(▼) button.</p>

Auto defrost chart

MENU NO.	WEIGHT (Increasing Unit) / UTENSILS	PROCEDURE
AD-1 Defrost  Steaks, Chops (initial temp -18°C)	0,2 - 1,0 kg (100 g) (see note on page 29)	<ul style="list-style-type: none"> Place the food on a plate in the centre of the turntable. When the oven stops and the audible signals sound, turn the food over, rearrange and separate. Shield the thin parts and warm spots with aluminium foil. After defrosting, wrap in aluminium foil for 10-15 minutes, until thoroughly defrosted.
AD-2 Defrost  Meat Joint (initial temp -18°C)	0,6 - 2,0 kg (100 g) (see note on page 29)	<ul style="list-style-type: none"> Place a plate upside down on the turntable and put the meat on it. When the oven stops and the audible signals sound, turn the food over. Shield the defrosted parts with aluminium foil. If audible signals sound, turn the food over and shield again (for 1,1 kg - 2,0 kg). After defrosting, cover with aluminium foil and stand for 15-30 minutes until thoroughly defrosted.
AD-3 Defrost  Minced Meat (initial temp -18°C)	0,2 - 1,0 kg (100 g) Cling film (see note on page 29)	<ul style="list-style-type: none"> Cover the turntable with cling film. Place the block of minced meat onto the turntable. When the oven stops and the audible signals sound, turn the food over. Remove the defrosted parts if possible. After defrosting, cover in aluminium foil for 5-10 minutes, until thoroughly defrosted.
AD-4 Defrost  Chicken Legs (initial temp -18°C)	0,20 - 1,00 kg (50 g) (see note on page 29)	<ul style="list-style-type: none"> Place the food on a plate in the centre of the turntable. When the oven stops and the audible signals sound, turn the food over, rearrange and separate. Shield the thin parts and warm spots with aluminium foil. After defrosting, wrap in aluminium foil for 10-15 minutes, until thoroughly defrosted.
AD-5 Defrost  Poultry (initial temp -18°C)	0,9 - 2,0 kg (100 g) (see note on page 29)	<ul style="list-style-type: none"> Place a plate upside down on the turntable and put the poultry breast side down on the plate. When the oven stops and the audible signal sounds, turnover and shield the thin parts and warm spots with aluminium foil. After defrosting, cover with aluminium foil and stand for 15-30 minutes until thoroughly defrosted. Finally clean the poultry under running water.
AD-6 Defrost  Cake (initial temp -18°C)	0,1 - 1,4 kg (100 g) Plate	<ul style="list-style-type: none"> Remove all packaging from the cake. Place on a plate in the centre of the turntable. After defrosting, cut the cake into similar sized pieces. Keep space between each piece and let stand for 15-30 minutes until thoroughly defrosted.
AD-7 Defrost  Bread (initial temp -18°C)	0,1 - 1,0 kg (100 g) Plate	<ul style="list-style-type: none"> Distribute on a plate in the centre of the turntable. Only sliced bread is recommended for this programme. When the audible signals sound rearrange, and remove defrosted slices. After defrosting separate all slices and distribute on a large plate. Cover the bread with aluminium foil and let stand for 5-10 minutes until thoroughly defrosted.

i Auto defrost chart

NOTES:

1. Steaks, Chops and Chicken legs should be frozen in one layer.
2. Minced meat should be frozen in the thin shape.
3. After turning over, shield the defrosted portions with small, flat pieces of aluminium foil.
4. The poultry should be processed immediately after defrosting.
5. Gateaux topped and coated with cream are very sensitive to microwave energy.

For the best result, if the cream begins to soften rapidly, it is best to remove it from the oven immediately and stand for 10 - 30 minutes at room temperature.

6. For AD-1, AD-2, AD-4 and AD-5 arrange the food in the oven as shown:

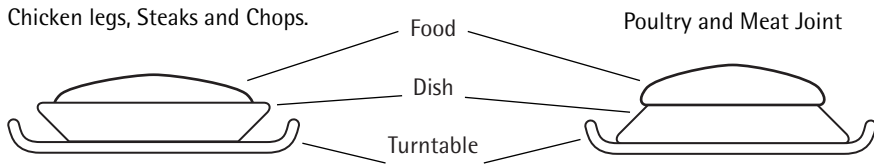

Recipes for auto cook AC-4

Baked courgettes and pasta

(This recipe makes approx. 1,5 kg).

Ingredients

500 ml	water
1/2 tsp	oil
	salt
80 g	Macaroni
400 g	tinned tomatoes, chopped
3	onion (150 g), finely chopped
	basil, thyme
	salt & pepper
1 tbsp	oil to grease the dish
450 g	courgette, sliced
150 g	sour cream
2	eggs
100g	grated cheddar

1. Put the water, oil and salt in the bowl, cover and bring to the boil.

3-5 min. ≈ 900 W

2. Break the macaroni into pieces and add them to the dish. Stir and allow to soak.

9-11 min. ≈ 270 W

Drain the pasta and allow to cool.

3. Mix the tomatoes with the onions and season well. Grease the ovenproof dish. Add the macaroni and pour the tomato sauce over. Arrange the courgette slices on top.

4. Beat the sour cream and the eggs and pour over the dish. Sprinkle the grated cheese.

Cook on the low rack using

AUTO COOK AC-4

Allow the dish to stand for approx. 5-10 minutes after cooking.

Baked broccoli and potato with mushrooms

(The recipe makes approx. 1,5 kg.)

Ingredients

400 g	potatoes, peeled and optionally halved
400 g	broccoli florets
6 tbsp	water (60 ml)
1 tsp	butter or margarine to grease the dish
400 g	mushrooms, sliced
1 tbsp	parsley, finely chopped
	salt & pepper
3	eggs
125 ml	cream
125 ml	milk
	salt & pepper
	nutmeg
100 g	grated gouda cheese

1. Put the potatoes and broccoli in the bowl.

Add the water, cover and cook.

Stir once during cooking.

9-12 min. ≈ 900 W

2. Slice the potatoes into discs.

3. Grease the oven-proof dish. Put in the broccoli, the mushrooms and the potatoes alternately in layers. Sprinkle over parsley and season with salt and pepper.

4. Combine the eggs with the liquid and seasoning, pour over the vegetables, then sprinkle the cheese over the dish.

Cook on the low rack using

AUTO COOK AC-4

Allow the dish to stand for approx. 10 minutes after cooking.

Recipes for auto cook AC-5

Carrot cake

(This recipe makes approx. 1,1 kg)

Ingredients

1 tsp	butter or margarine to grease the dish
5	egg yolks
250 g	sugar
250 g	carrot, finely grated
	juice of one lemon
250 g	ground almonds
80 g	flour
1 tbsp	baking powder
5	egg white

1. Grease the dish.
2. Cream the egg yolks and sugar with a hand mixer.
3. Add the carrots, lemon juice and almonds.
4. Combine the flour and the baking powder, add to the rest and mix well.
5. Beat the egg white until stiff and carefully fold it in. Put the mixture in the baking tin, place it on the low rack and bake using.
AUTO COOK AC-5
6. Allow to cool in the tin for 5 minutes after baking.

Gugelhupf

(Dough will weigh approx. 0,9 kg)

Ingredients

1 tsp	butter or margarine to grease the dish
170 g	butter or margarine
140 g	icing sugar
4	egg yolks
40 g	slivered almonds
40 g	raisins, washed, some finely grated lemon peel
4	egg whites
280 g	flour
1 Pck.	baking powder (15 g)

1. Grease the gugelhupf mould.
2. Beat the butter and the icing sugar with a mixer until smooth. Add the egg yolks one at a time.
3. Gradually stir in slivered almonds, raisins and the finely grated lemon peel. Mix well.
4. Beat the egg whites until stiff and fold into the mixture. Mix baking powder and flour, sift and carefully fold it into the mixture.
5. Transfer the dough to the mould and bake on the low rack using

AUTO COOK AC-5

Recipes for auto cook AC-5

Apple tart with calvados

(This recipe makes approx. 1,3 kg)

Ingredients

200 g flour
1 tsp baking powder
100 g sugar
1 Pck. vanilla sugar
1 pinch salt
1 egg
3-4 drop bitter almond oil
125 g butter
1 tsp butter or margarine to grease the dish
50 g ground hazelnuts
600 g apple (russets approx. 3-4)
cinnamon
2 eggs
1 pinch salt
4 tbsp sugar
4 tbsp calvados (apple liqueur)
11/2 tbsp cornflour
125 g double cream
icing sugar for dusting

1. Mix the flour with the baking powder. Add the sugar, vanilla sugar, salt, the egg, bitter almond oil and butter and knead to a paste with the kneading hook of a hand mixer.
2. Cover the pastry dough and leave in a cool place for about 30 minutes.
3. Grease the dish. Roll out the pastry dough between two sheets of foil and place it in the tin. Form an edge to the pastry dough approx. 3 cm high.
4. Distribute the hazel nuts over the pastry shell.
5. Peel the apples, cut them in quarters, remove the core and cut them in slices. Arrange the slices to overlap each other on top of the hazel nuts and lightly dust them with cinnamon.
6. Separate the eggs. Beat the egg whites until stiff, gradually trickling in a pinch of salt and 1 tbsp sugar.
7. Stir the egg yolk, the remaining sugar and the vanilla sugar until creamy.
8. Add Calvados, cornflour and double cream and mix them in. Fold in the beaten egg whites and spread the mixture evenly over the apple slice.
9. Place on the low rack and bake using.

AUTO COOK AC-5

Tip: Allow the tart to cool in the tin and dust it with icing sugar.

i Care & cleaning

CAUTION: DO NOT USE COMMERCIAL OVEN CLEANERS, STEAM CLEANERS, ABRASIVE, HARSH CLEANERS, ANY THAT CONTAIN SODIUM HYDROXIDE OR SCOURING PADS ON ANY PART OF YOUR MICROWAVE OVEN.

WARNING!

After **GRILL, DUAL, CONVECTION, AUTO COOK, AUTO COOK FROM FROZEN** modes, the oven cavity, door, oven cabinet and accessories will become very hot. Before cleaning, make sure they are completely cool.

CLEAN THE OVEN AT REGULAR INTERVALS AND REMOVE ANY FOOD DEPOSITS. Failure to maintain the oven in a clean condition could lead to a deterioration of the surface that could adversely affect the life of the appliance and possibly result in a hazardous situation.

Oven exterior

The outside of your oven can be cleaned easily with mild soap and water. Make sure the soap is wiped off with a moist cloth, and dry the exterior with a soft towel.

Oven controls

Open the door before cleaning to de-activate the oven controls. Care should be taken when cleaning the oven control. Using a cloth dampened with water only, gently wipe the panel until it becomes clean. Avoid using excessive amounts of water. Do not use any sort of chemical or abrasive cleaner.

Oven Interior

1. For cleaning, wipe any splatters or spills with a soft damp cloth or sponge after each use while the oven is still warm. For heavier spills, use a mild soap and wipe several times with a damp cloth until all residues are removed. Do not remove the waveguide cover.
2. Make sure that mild soap or water does not penetrate the small vents in the walls which may cause damage to the oven.
3. Do not use spray type cleaners on the oven interior.
4. Heat up your oven regularly by using the convection and grill, refer to "Heating without food" on page 11. Remaining food or fat splashed can cause smoke or bad smell.

Turntable & turntable support

Remove the turntable and turntable support from the oven. Wash the turntable and turntable support in mild soapy water. Dry with a soft cloth. Both the turntable and the turntable support are dishwasher safe.

Door

To remove all trace of dirt, regularly clean both sides of the door, the door seals and sealing surfaces with a soft, damp cloth.

NOTE: A steam cleaner should not be used.

What to do if...



... the microwave appliance is not working properly ?

Check that

- the fuses in the fuse box are working,
- there has not been a power outage.
- If the fuses continue to blow, please contact an authorised Service Force Centre.



... the microwave mode is not working ?

Check that

- the door is properly closed,
- the door seals and their surfaces are clean,
- the START/QUICK-button has been pressed



... the turntable is not turning ?

Check that

- the turntable support is correctly connected to the drive,
- the ovenware does not extend beyond the turntable,
- food does not extend beyond the edge of the turntable preventing it from rotating.
- there is nothing in the well beneath the turntable.



... the microwave will not switch off ?

- Isolate the appliance from the fuse box.
- Contact an authorised Service Force Centre.



... the interior light is not working ?

- Call an authorised Service Force Centre. The interior light bulb can be exchanged only by an authorised Service Force Centre.





... the food is taking longer to heat through and cook than before ?

- Set a longer cooking time (double quantity = nearly double time) or
- if the food is colder than usual, rotate or turn from time to time or
- set a higher power setting.

IMPORTANT: If the display shows nothing even if the power plug is properly connected, the energy save mode should carry on. To release it, open and then close the oven door. See page 8.

1. If you cook the food over the standard time with only 900 W, the power of the oven will lower automatically to avoid overheating. (The microwave power level will be reduced.)

Cooking mode	Standard time
Microwave 900 W cooking	20 min.
Grill cooking	15 min.
Dual 1 	Micro - 40 min.
Dual 2  (900 W microwave power)	Micro - 15 min. Grill - 15 min.
Dual 2  (630 W microwave power)	Micro - 40 min. Grill - 15 min

2. After **GRILL, DUAL, CONVECTION, AUTO COOK, AUTO COOK FROM FROZEN** the cooling fan will run and "NOW COOLING" may appear on the display. Also, when you press the **STOP** button and open the door during these cooking modes, the cooling fan will run; you may, therefore, feel air blowing from the ventilation openings.

Service & spare parts

If you wish to purchase spare parts or require an engineer, contact your local AEG-Electrolux Service Force Centre by telephoning:

08705 929 929

Your telephone call will be automatically routed to the Service Force Centre covering your post code area.

For the address of your local Service Force Centre and further information about Service Force, please visit the website at:

www.serviceforce.co.uk

When you contact the Service Force Centre they will need the following information:

1. Your name & address, including post code.
2. Your telephone number
3. Clear and concise details of the fault.
4. The model and serial number of the appliance (found on the rating plate).
5. The purchase date:
Please note that a valid purchase receipt or guarantee documentation is required for in-guarantee service calls.

Customer care

For general enquiries concerning your AEG-Electrolux appliance or for further information on AEG-Electrolux products please contact our Customer Care Department by letter or telephone at the address below or visit our website at:

www.aeg.co.uk

Customer Care Department
Major Appliances
Addington Way
Luton
Bedfordshire
LU4 9QQ

Tel. 08705 350350 (*)

(*) Calls may be recorded for training purposes.

For Customer Service in Ireland please contact us at the address below:

AEG-Electrolux
Electrolux Group (Irl) Ltd
Long Mile Road
Dublin 12
Republic of Ireland

Tel: + 353 (0)1 4090754

Email: service.eid@electrolux.ie

Guarantee conditions

Standard guarantee conditions

We, AEG-Electrolux, undertake that if within 12 months of the date of the purchase this AEG-Electrolux appliance or any part thereof is proved to be defective by reason only of faulty workmanship or materials, we will, at our discretion repair or replace the same FREE OF CHARGE for labour, materials or carriage on condition that:

- The appliance has been correctly installed and used only on the electricity or gas supply stated on the rating plate.
- The appliance has been used for normal domestic purposes only, and in accordance with the manufacturer's operating and maintenance instructions.
- The appliance has not been serviced, maintained, repaired, taken apart or tampered with by any person not authorised by us.
- All service work under this guarantee must be undertaken by a Service Force Centre. Any appliance or defective part replaced shall become the Company's property.
- This guarantee is in addition to your statutory and other legal rights.
- Home visits are made between 8.30am and 5.30pm Monday to Friday.
Visits may be available outside these hours in which case a premium will be charged.

Exclusions

This guarantee does not cover:

- Damage or calls resulting from transportation, improper use or neglect, the replacement of any light bulbs or removable parts of glass or plastic.
- Costs incurred for calls to put right an appliance which is improperly installed or calls to appliances outside the United Kingdom.
- Appliances found to be in use within a commercial environment, plus those which are subject to rental agreements.
- Products of AEG-Electrolux manufacture which are not marketed by AEG-Electrolux.

European Guarantee

If you should move to another country within Europe then your guarantee moves with you to your new home subject to the following qualifications:

- The guarantee starts from the date you first purchased your product.
- The guarantee is for the same period and to the same extent for labour and parts as exists in the new country of use for this brand or range of products.
- This guarantee relates to you and cannot be transferred to another user.
- Your new home is within the European Community (EC) or European Free Trade Area.
- The product is installed and used in accordance with our instructions and is only used domestically, i.e. a normal household.
- The product is installed taking into account regulations in your new country.

Before you move please contact your nearest Customer Care centre, listed below, to give them details of your new home. They will then ensure that the local Service Organisation is aware of your move and able to look after you and your appliances.

France	Senlis	+33 (0) 3 44 62 29 29
Germany	Nürnberg	+49 (0) 800 234 7378
Italy	Pordenone	+39 (0) 800 117511
Sweden	Stockholm	+46 (0) 8 672 5360
UK	Luton	+44 (0) 1753 219899

Specifications

AC Line Voltage	: 230-240V, 50 Hz, single phase
AC Power required:	Microwave : 1.55 kW Grill : 2.85 kW Grill/Microwave : 2.95 kW Convection : 2.85 kW Convection/Microwave : 2.95 kW
Output power:	Microwave : 900 W (IEC 60705) Grill heating elements : 1400 W (700 W x2) Convection : 1400 W
Microwave Frequency	: 2450 MHz * (Group 2/Class B)
Outside Dimensions	: 592 mm (W) x 462 mm (H) x 537 mm (D)
Cavity Dimensions	: 375 mm (W) x 272 mm (H) x 395 mm (D) **
Oven Capacity	: 40 litres **
Turntable	: ø362 mm, ceramic
Weight	: 30 kg
Oven lamp	: 25 W/240 - 250 V

- * This Product fulfils the requirement of the European standard EN55011.
In conformity with this standard, this product is classified as group 2 class B equipment.
Group 2 means that the equipment intentionally generates radio-frequency energy in the form of electromagnetic radiation for the heat treatment of food.
Class B equipment means that the equipment is suitable to be used in domestic establishments.

- ** Internal capacity is calculated by measuring maximum width, depth and height.
Actual capacity for holding food is less.



This equipment complies with the requirements of directives 89/336/EEC and 73/23/EEC as amended by 93/68/EEC.

As part of a policy of continuous improvement, we reserve the right to alter design and specifications without notice.

Important information



Ecologically responsible disposal of packaging materials and old appliances



Packaging materials

AEG-Electrolux microwave ovens require effective packaging to protect them during transportation.

Only the minimum packaging necessary is used.



Packaging materials (e.g. foil or styrofoam) can place children at risk.

Danger of suffocation. Keep packaging material away from children.



All packaging materials used are environment friendly and can be recycled. The cardboard is made from recycled paper and the wooden parts are untreated. Plastic items are marked as follows:

«PE» polyethylene eg packaging film

«PS» polystyrene eg packaging (CFC-free)

«PP» polypropylene eg packaging straps

By using and re-using the packaging, raw materials are saved and waste volume is reduced.

Packaging should be taken to your nearest recycling centre.

Contact your local council for information.



Disposal of old appliances

Old appliances should be made safe before disposal by removing the plug, and cutting off and disposing of the power cable.

It should then be taken to the nearest recycling centre. Check with your local Council or Environmental Health Office to see if there are facilities in your area for recycling the appliance.

i Installation

INSTALLING THE APPLIANCE

1. Remove all packaging and check carefully for any signs of damage.
2. If the microwave is fitted in position C, ensure that the minimum air gaps are maintained as shown in the diagram.
3. Secure four cupboard retention blocks in position using the setting template (TMAPTA004URRO).
4. Fit the appliance into the kitchen cupboard, lift over the bottom/front blocks then push slowly, and without force, until the front frame of the oven seals against the front opening of the cupboard.
5. Ensure the appliance is stable and not leaning.
6. Fix the oven in position with the screws provided. The fixing points are located within the louvre areas at the top and bottom of the oven (see diagram, item 1, on page 4).
7. Fit the frame fastener caps to the four fixing positions (2 spare caps are provided).
8. It is important to ensure that the installation of this product conforms to the instructions in this operation manual and the conventional oven or hob manufacturer's installation instructions.

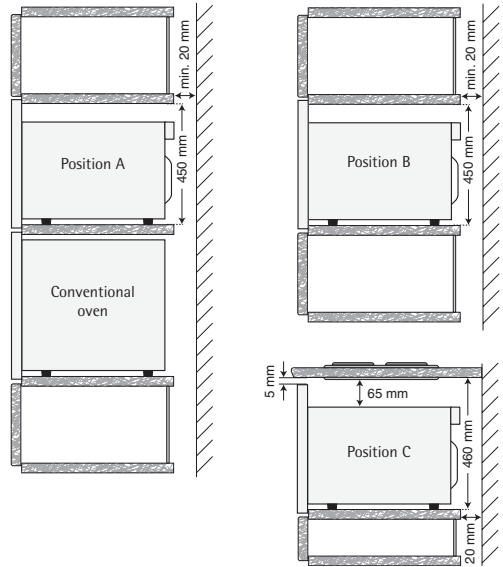

The microwave can be fitted in position A, B or C:

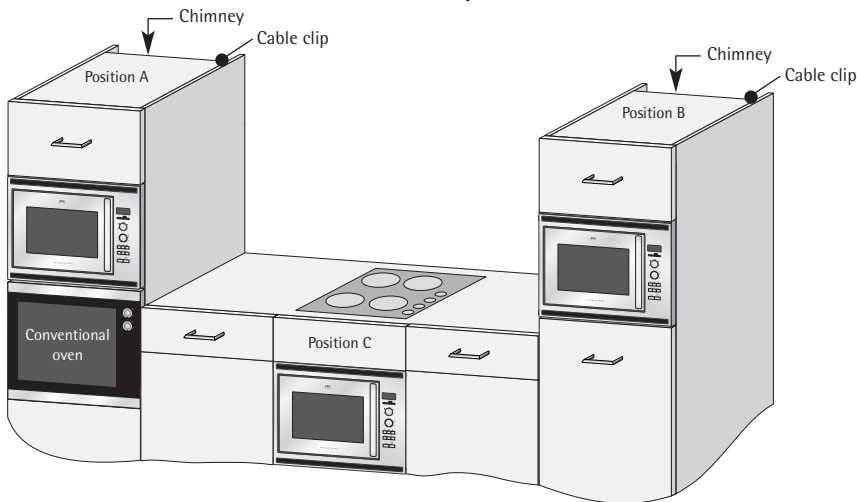

POSITION	NICHE SIZE			CHIMNEY (min)	Gap Between Cupboard & Ceiling
	W	D	H		
A	560	550	450	20	50
B	560	550	450	20	50
C	560	550	460	20	Not Applicable

Measurements in (mm)

Installation

CONNECTING THE APPLIANCE TO THE POWER SUPPLY

- The electrical outlet should be readily accessible so that the unit can be unplugged easily in an emergency.
- The socket should not be positioned behind the cupboard.
- The best position is above the cupboard, see (A).
If connection is to be made to position (A), remove the clip from position 15 on the rear of the oven (see page 4) and use the clip to secure the power supply cord to the top of the housing unit (see page 39). When not connecting the power supply cord to position (A), the power supply cord should be routed under the oven.
- Connect the appliance to a single phase 230-240V/50Hz alternating current via a correctly installed earth socket. The socket must be fused with a 16A fuse.
- If the appliance is to be operated in a non-European country, the supply voltage, current type and frequency of the appliance indicated on the rating plate must correspond with the specification of your power supply. The rating plate can be found on the inside face of the control panel.
- The power supply cord may only be replaced by an electrician.
- Before installing, tie a piece of string to the power supply cord to facilitate connection to point (A) when the appliance is being installed.
- When inserting the appliance into the high-sided cupboard, DO NOT crush the power supply cord.

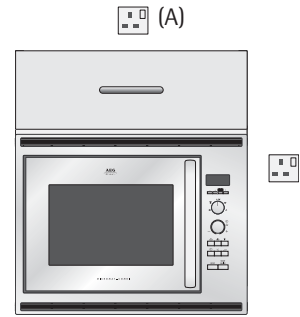

ELECTRICAL CONNECTIONS

 **WARNING:**
THIS APPLIANCE MUST BE EARTHED
The manufacturer declines any liability should this safety measure not be observed.

- If the plug that is fitted to your appliance is not suitable for your socket outlet, it must be cut off and the appropriate plug fitted.
- Remove the fuse from the cut off plug. The cut off plug should then be disposed of to prevent the hazard of shocks in case it should be plugged into a 13 Amp socket in another part of your home.

IMPORTANT

The wires in the mains lead are coloured in accordance with the following code:

GREEN AND YELLOW	EARTH
BLUE	NEUTRAL
BROWN	LIVE

If you fit your own plug, the colours of the wires in the mains lead of your appliance may not correspond with the markings identifying the terminals in your plug, proceed as follows:

- Connect the green and yellow (earth) wire to the terminal in the plug which is marked with the letter "E" or the earth symbol () or coloured green and yellow.
- Connect the blue (neutral) wire to the terminal in the plug which is marked with the letter "N" or coloured black.
- Connect the brown (live) wire to the terminal in the plug which is marked with the letter "L" or coloured red.

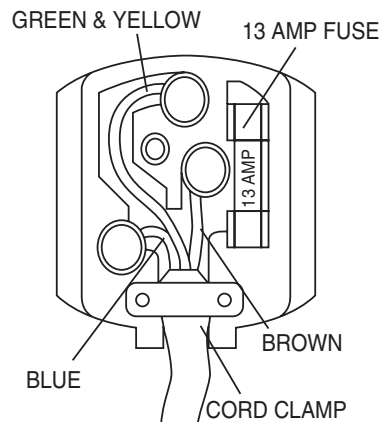

Major Appliances
Addington Way
Luton
Bedfordshire
LU4 9QQ

Telephone: 08705 350350

© Electrolux plc 2005

TINS-A391URR0△

Printed on paper manufactured with
environmentally sound processes.
He who thinks ecologically acts accordingly ...