

**JLWFF1102**

**Wine cooler fridge freezer**

Instruction manual

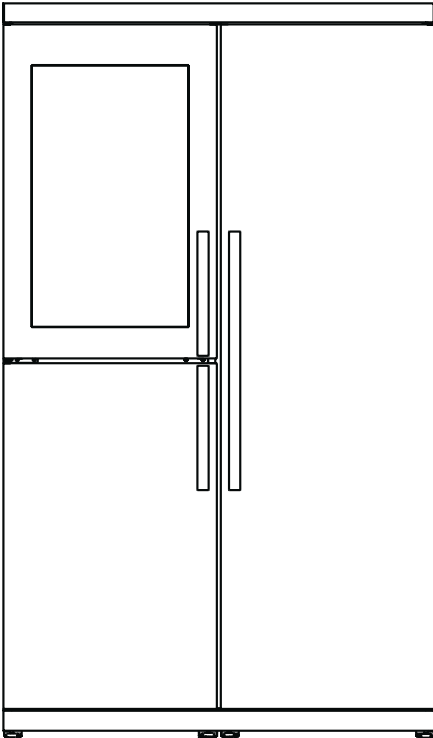

**John Lewis**

# Important Safety Information

It is most important that this instruction book should be retained with the appliance for future reference. Should the appliance be sold or transferred to another owner, or should you move house and leave the appliance, always ensure that the book is supplied with the appliance in order that the new owner can get to know the functioning of the appliance and the relevant warnings.

These warnings have been provided in the interest of safety. You **MUST** read them carefully before use of installation by a qualified person. If you are unsure of the meanings of these warnings contact the John Lewis branch from which you purchased the appliance.

## Installation

- Any electrical work required to install this appliance should be carried out by a qualified and competent personnel to the relevant National Standards.
- This appliance is heavy. Care should be taken when moving it.
- Do not attempt to modify this product in any way.
- Care must be taken to ensure that the appliance does not stand on the electrical supply cable. **Important:** if the supply cable is damaged, please contact our extended warranty administrators who will put you in touch with your local Service Force Repair Centre for further advice.
- The appliance should be left for 2 hours after installation before it is turned on, in order to allow the refrigerant to settle.
- Parts which heat up should not be exposed. Whenever possible, the back of the appliance should be close to a wall but leaving the required distance for ventilation as stated in the installation instructions.

## Child Safety

- This appliance is designed to be operated by adults. Do not allow children to tamper with the controls or play with the product.
- Keep all packaging away from children.

## General Safety

- This appliance contains hydrocarbons in its cooling unit; maintenance and recharging must therefore only be carried out by authorised technicians.
- Take utmost care when handling your appliance so as not to cause any damages to the cooling unit with consequent possible fluid leakages.
- The appliance must not be located close to cookers, radiators or boilers.
- Avoid prolonged exposure of the appliance to direct sunlight.
- Do not use other electrical appliances (such as ice cream makers) inside of refrigerating appliances.

## Use

- This appliance is designed for domestic use only, specifically for the storage of edible foodstuffs.
- Frozen food must NOT be re-frozen once it has thawed out.
- Do not place carbonated or fizzy drinks in the freezer.
- Do not remove items from the freezer if your hands are damp/wet, as this could cause skin abrasions or frost/freezer burns.
- Ice lollies can cause 'frost/freezer burns' if consumed straight from the freezer.
- Manufacturers' storage recommendations should be strictly adhered to. Refer to relevant instructions.
- The cooling plate or refrigerated freezer shelves in this appliance contain channels through which the refrigerant passes. If these are punctured this will cause substantial damage to the appliance and result in food loss. **DO NOT USE SHARP INSTRUMENTS** to scrape off frost or ice. Under NO circumstances should solid ice be forced off the lining or shelves. Solid ice should be allowed to thaw, when defrosting the appliance. See Defrost Instructions.

## Maintenance and Cleaning

- Switch off and unplug the appliance before carrying out any cleaning or maintenance work.

## Service

- This product should be serviced by an authorised engineer and only genuine spare parts should be used.



## Environmental Information

- After installation, please dispose of the packaging with due regard to safety and the environment.
- When disposing of your appliance use an authorised disposal site. Remove the plug and ensure that all locks and catches are removed to prevent young children being trapped inside.
- The symbol  on the product or on its packaging indicates that this product may not be treated as household waste. Instead it should be taken to the appropriate collection point for the recycling of electrical and electronic equipment. By ensuring this product is disposed of correctly, you will help prevent potential negative consequences for the environment and human health, which could otherwise be caused by inappropriate waste handling of this product. For more detailed information about recycling of this product, please contact your local council, your household waste disposal service or the shop where you purchased the product.



## Ecological hints

To save energy and help protect the environment, we recommend that you follow these hints.

Do not install the appliance close to sources of heat such as a boiler or radiator.

Locate the appliance in a well-ventilated room and make sure that any air openings of the appliance are not obstructed.

Pack all foods into airtight packages before placing them into the freezer compartment.

Food, which is to be frozen (when cool), should be placed in the fridge compartment before being transferred to the freezer.

Try to avoid keeping the door open for long periods or opening the door too frequently as warm air will enter the cabinet and cause the compressor to switch on unnecessarily often.

Ensure there are no obstructions preventing the door from closing properly.



## Warning

IF YOU ARE DISCARDING AN OLD APPLIANCE THAT HAS A LOCK OR CATCH ON THE DOOR, YOU MUST ENSURE THAT IT IS MADE UNUSABLE TO PREVENT YOUNG CHILDREN BEING TRAPPED INSIDE.

## Positioning

This appliance should only be installed at a location where the ambient temperature corresponds to the climate classification indicated on the rating plate, which is located at the left on the inside of the appliance.

The following table shows which ambient temperature is correct for each climate classification:

SN	+10°C	to	+32°C
N	+16°C	to	+32°C
ST	+18°C	to	+38°C
T	+18°C	to	+43°C

It should be located in a dry atmosphere, out of direct sunlight and away from extreme temperature e.g. not next to a boiler or radiator, or in a very cold room e.g. an outhouse. If these temperatures are exceeded i.e. colder or warmer, then the appliance may not operate correctly.

## Important

It must be possible to disconnect the appliance from the mains power supply; the plugs must therefore be easily accessible after installation.

# Contents

## For the user

Important safety information	2
Description of the appliance	5
Electrical connection	6
The control panel refrigerator	7
When the fridge is first installed	7
Switching off	7
Temperature setting buttons	7
Using the refrigerator	8
Before use	8
Temperature display	8
Quick cool	8
Fresh food refrigeration	8
Normal operating sounds	8
Movable shelves	9
Positioning the door shelves	9
Air recycling	9
Storage time chart (refrigerator)	10
The control panel wine cooler	11
When the wine cooler is first installed	11
Temperature setting buttons	11
Temperature display	12
Switching the appliance off	12
Using the wine cooler	13
Wine cooler	13
Movable shelves	13
Normal operating sounds	13
The control panel freezer	14
Temperature setting buttons	14
Temperature display	14
Starting up - setting the temperature	14
Quick freeze	15

Alarm reset button	15
Switching the appliance off	15
Using the freezer	16
Before use	16
Freezing fresh food	16
Frozen food storage	16
Thawing	16
How to make ice cubes	16
Cold accumulators	16
Hints and tips	17
Maintenance and cleaning	18
Internal cleaning	18
When the appliance is not in use	18
External cleaning	18
Changing the light bulb	18
Defrosting	19
Something not working	20
Repairs - After sales service	21
Installation	22
Technical specifications	22

## Guide to use the instruction manual

The following symbols will be found in the text to guide you throughout the instructions:

 Safety instructions

 Hints and tips

 Environmental information

 This appliance complies with the following E.E.C. Directives:

- \* 73/23 - 90/683 (Low Voltage Directive);
- \* 93/68 ("General Product Safety Directive");
- \* 87/308 (Radio Interference Suppression);
- \* 89/336 (Electromagnetic Compatibility Directive) and subsequent modifications.

# Description of the appliance

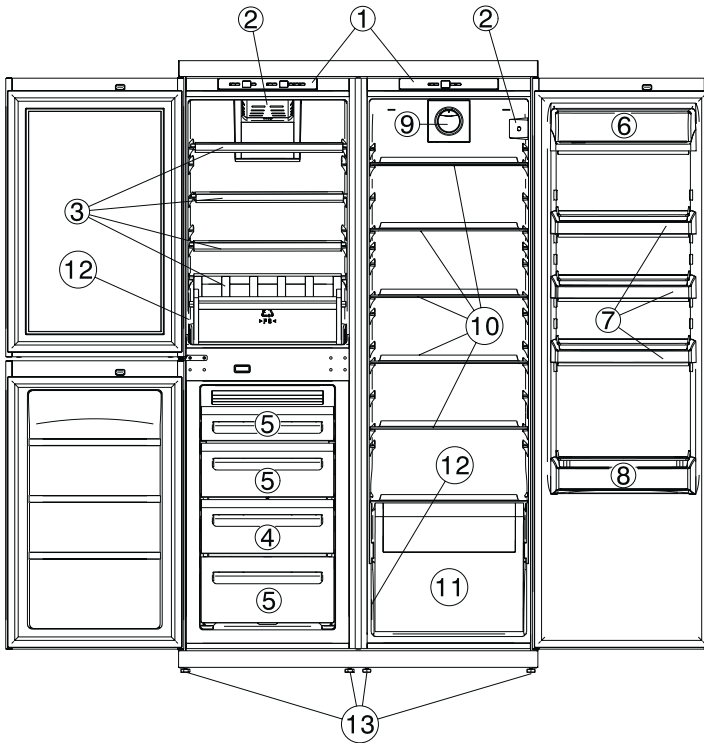

- |    |                                  |     |                        |
|----|----------------------------------|-----|------------------------|
| 1. | Control panel                    | 8.  | Bottle shelf           |
| 2. | Interior lights                  | 9.  | Quick cool system      |
| 3. | Bottle shelves                   | 10. | Glass shelves          |
| 4. | Freezing fresh food compartment  | 11. | Salad/vegetable drawer |
| 5. | Frozen food storage compartments | 12. | Rating plate           |
| 6. | Dairy compartment                | 13. | Adjustable feet        |
| 7. | Moveable storage shelves         |     |                        |

# Electrical connection

Any electrical work required to install this appliance should be carried out by a qualified electrician or competent person.



**WARNING: THIS APPLIANCE MUST BE EARTHED.**

Should the appliance power supply cables need to be replaced, this must be carried out by a Service Force agent (see page 22)

The manufacturer declines any liability should this safety measure not be observed.

Before switching on, make sure the electricity supply voltage is the same as that indicated on the appliance's rating plate. (See picture on page 5).

The appliances are supplied with 2 x 13amp independent plugs.

In the event of having to change the fuse in the plug supplied, a 13amp ASTA approved BS 1363/A fuse must be used.

Should the plug need to be replaced for any reason, proceed as described below. The wires in the mains lead are coloured in accordance with the following code:

Green and Yellow	- Earth
Blue	- Neutral
Brown	- Live

If you fit your own plug, the colours of the wires in the mains lead of your appliance may not correspond with the markings identifying the terminals in your plug.

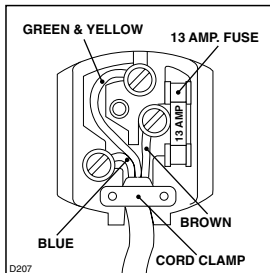

**Proceed**

**as follows:**

1. Connect the Green and Yellow (earth) wire to the terminal in the plug which is marked with the letter "E" or the earth symbol  $\oplus$  or coloured green and yellow.
2. Connect the Blue (neutral) wire to the terminal in the plug which is marked with the letter "N" or coloured black.
3. Connect the Brown (live) wire to the terminal in the plug which is marked with the letter "L" or coloured red.

4. Upon completion there must be no cut, or stray strands of wire present and the cord clamp must be secure over the outer sheath.



**WARNING: A cut off plug inserted into a 13 amp socket is a serious safety (shock) hazard.**

Ensure that the cut off plug is disposed of safely.



The plugs must still be accessible after the appliance has been installed.



The appliance should not be connected to the electrical supply by means of an extension cable.

# The control panel refrigerator

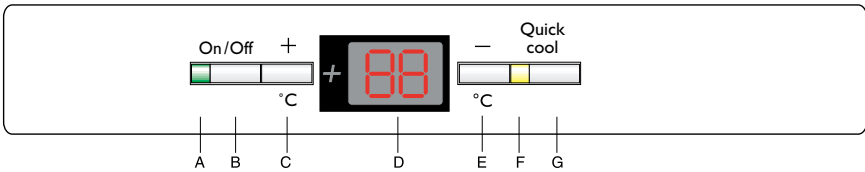

- A. Mains indicator light (green)
- B. Fridge compartment ON/OFF
- C. Temperature setting button (+) (for warmer temperatures)
- D. Temperature display
- E. Temperature setting button (-) (for colder temperatures)
- F. Quick cool function "on" indicator light (yellow)
- G. Quick cool button

## When the fridge is first installed



### Warning

**Allow the appliance to stand for 2 hours after installation.**

Insert the plugs into the wall socket.

If the display is OFF press the ON/OFF button.

The green mains indicator light illuminates.

The appliance starts.

Press either the "C" (+) or "E" (-) button. The temperature display switches over and the DESIRED temperature currently set flashes on the temperature display.

Set the required temperature by pressing the "C" (+) or "E" (-) buttons (see section "Temperature setting buttons"). The temperature display will immediately show the changed setting. Each time a button is pressed the temperature is adjusted by 1 °C.

From a food safety point of view +5 °C should be considered sufficiently cold for storing food in the fridge.

Once the required temperature has been set, after a short period (approx. 5 sec.) the temperature display will change and again indicate the current ACTUAL temperature inside the fridge. The display will change from flashing to continuous illumination.

**Information!** When the setting is changed, the compressor does not start immediately if automatic defrosting is currently taking place. As the storage temperature within the fridge is reached quickly you can store food immediately after switching on.

## Switching off

The appliance is switched off by holding in button (B) for more than 1 second. After this, a countdown on the temperature display from -3 -2 -1 will be shown.

When the appliance is switched off, the display (D) also goes off.

## Temperature setting buttons

The temperature is adjusted using the "C" (+) and "E" (-) buttons. These buttons are connected to the temperature display.

The temperature display is switched over from the display of the ACTUAL temperature (Temperature display is illuminated) to the display of the DESIRED temperature (Temperature display flashes) by pressing one of the two buttons, "C" (+) or "E" (-).

Each time one of the two buttons is pressed again the DESIRED temperature is adjusted by 1 °C. The DESIRED temperature must be reached within 24 hours.

If neither button is pressed, the temperature display automatically switches back after a short period (approx. 5 sec.) to the display of the ACTUAL temperature.

### DESIRED temperature means:

The temperature that has been selected for inside the fridge. The DESIRED temperature is indicated by flashing numbers.

### ACTUAL temperature means:

The temperature display indicates the current temperature inside the fridge. The ACTUAL temperature is indicated with illuminated numbers.

# Using the refrigerator

## Before use

Remove all securing tapes. Wash inside the appliance with lukewarm water and bicarbonate of soda (5 ml to 0.5 litre of water).

**Do not use soap or detergent as the smell may linger. Dry thoroughly.**

## Temperature display

The temperature display can indicate several pieces of information.

During normal operation, the temperature currently present in the fridge (ACTUAL temperature) is displayed.

When the temperature is being adjusted a flashing display indicates the fridge temperature currently set (DESIRED temperature).

## Quick cool

The Quick cool function is suitable for quickly cooling large quantities of fresh food in the refrigerator.

The Quick cool function is switched on by pressing the Quick cool button "G". The yellow light illuminates. The Quick cool function is ended automatically after a period of 6 hours.

The Quick cool function can be ended manually at any time by pressing the Quick cool button again.

The yellow light goes out.

## Fresh food refrigeration

To obtain the best performance, do not store warm food or evaporating liquids in the refrigerator; do cover or wrap the food, particularly if it has a strong flavour.

Do not cover the shelves with any protective material, such as paper, cardboard or plastic, which may obstruct the air circulation through them.

To help you use your refrigerator correctly, here are some more useful hints:

**Raw meat** (beef, pork, lamb & poultry): wrap in polythene bags and place on top of the salad drawer.

**Meat can only be stored safely in this way for one or two days at the most.**

**Fruit & vegetables:** these should be thoroughly cleaned and placed in the bottom salad drawer.

**Butter & cheese:** these should be placed in special airtight containers or wrapped in aluminium foil or polythene bags to exclude as much air as possible.

**Milk bottles:** these should have a cap and should be stored in the bottle rack on the door.

## Normal operating sounds

- You may hear faint gurgling or bubbling sounds when the refrigerant is pumped through the coils or tubing at the rear, to the cooling plate/evaporator or to the fixed freezer shelves.
- When the compressor is on, the refrigerant is being pumped round, and you will hear a whirring sound or pulsating noise from the compressor.



## Movable shelves

The walls of the refrigerator have runners so that the shelves can be positioned as desired.

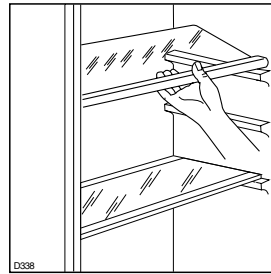

## Positioning the door shelves

To accommodate the storage of larger items, the door shelves can be adjusted in height.

To adjust the shelves proceed as follows:

Gradually pull the shelf in the direction of the arrows until it comes off, then reposition as required.

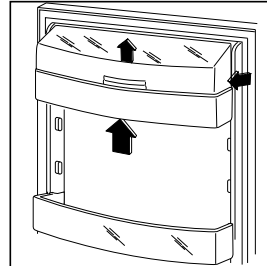

## Air recycling

The refrigerator compartment is equipped with a special D.A.C.(Dynamic Air Cooling) fan which can be turned on with the switch (fig.1).When the green light is on, the fan system is working.

It is recommended that the fan (D.A.C.) be used when the ambient room temperature exceeds 25°C.

This feature enables the rapid cooling of foods and a more uniform temperature in the compartment.

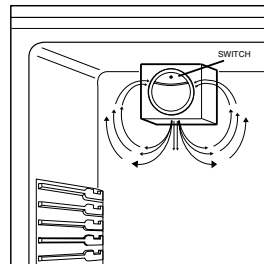

Fig. 1

# Storage time chart (refrigerator)

## Time and method of storage of fresh foods in the refrigerator

Foods	Storage time in days							Method of packaging
	1	2	3	4	5	6	7	
Raw meat	X	X	x	x	x			cling film, airtight
Cooked meat	X	X	X	x	x	x		dish covered
Roasted meat	X	X	X	x	x			dish covered
Raw minced meat	X							dish covered
Cold cuts, Vienna sausage	X	X	x	x				cling film, cellophane, grease-proof paper
Fresh fish	X	x	x					cling film, airtight
Cooked fish	X	X	x	x				dish covered
Fried fish	X	X	x	x	x			dish covered
Tinned fish, open	X	x	x					dish covered
Fresh chicken	X	X	X	x	x	x		cling film, airtight
Fried chicken	X	X	X	x	x	x		dish covered
Fresh duck, goose	X	X	X	x	x	x		cling film, airtight
Roasted duck, goose	X	X	X	X	x	x	x	dish covered
Butter unopened	X	X	X	X	X	X	X	original packaging
Butter opened	X	X	X	X	X	X	X	original packaging
Milk	X	X	X	x	x			original packaging
Cream	X	X	x	x				plastic box
Sour cream	X	X	X	X	x	x	x	plastic box
Cheese (hard)	X	X	X	X	X	X	X	aluminium foil
Cheese (soft)	X	X	X	X	x	x	x	cling film
Curds	X	X	X	X	x	x	x	cling film
Egg	X	X	X	X	X	X	X	
Spinach, sorrel	X	X	x	x				cling film
Green peas, green beans	X	X	X	X	x	x	x	cling film
Mushroom	X	X	x	x	x			cling film
Carrot, roots	X	X	X	X	X	X	X	cling film
Bell-pepper	X	X	x	x	x			cling film
Tomato	X	X	X	X	X	X	X	cling film
Cabbage	X	X	X	X	X	x	x	cling film
Soft fruits (strawberries, raspberries, etc.)	X	X	X	x	x			cling film
Other fruits	X	X	X	X	x	x	x	cling film
Tinned fruits opened	X	X	X	x	x			dish covered
Cakes filled with cream	X	X	x	x				dish covered

### Notation:

**X** usual storage time

**x** possible storage time (concerns to really fresh product only)

# The control panel wine cooler

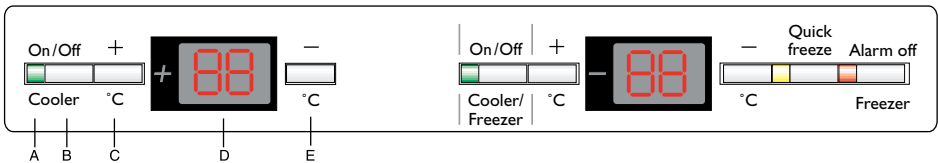

- A. Mains indicator light (green)
- B. Wine cooler button On/Off
- C. Temperature setting button (+) (for warmer temperatures)
- D. Temperature display
- E. Temperature setting button (-) (for colder temperatures)

## When the wine cooler is first installed



### Warning

**Allow the appliance to stand for 2 hours after installation.**

Insert the plug into the wall socket.

Press On/Off, button B can function the Wine cooler separately with the appliance in function.

The green mains indicator light illuminates.

Press either the "C" (+) or "E" (-) button. The temperature display switches over and the DESIRED temperature currently set flashes on the temperature display.

Set the required temperature by pressing the "C" (+) or "E" (-) buttons (see section "Temperature setting buttons"). The temperature display will immediately show the changed setting. Each time the button is pressed the temperature is adjusted by 1 °C.

Once the required temperature has been set, after a short period (approx. 5 sec.) the temperature display will change and again indicate the current ACTUAL temperature inside the Wine Cooler.

The display will change from flashing to continuous illumination.

**Information!** When the setting is changed, the compressor does not start immediately if automatic defrosting is currently taking place. As the storage temperature within the Wine cooler is reached quickly you can store beverage immediately after switching on.

**Important:** If the wine cooler is switched off, the door must be closed to ensure that the freezer is working properly.

**When switched off, the electronic control of the appliance functions automatically and periodically circulating the air to prevent unpleasant smells and humidity within the compartment.**

## Temperature setting buttons

The temperature is adjusted using the "C" (+) and "E" (-) buttons. These buttons are connected to the temperature display.

The temperature display is switched over from the display of the ACTUAL temperature (Temperature display is illuminated) to the display of the DESIRED temperature (Temperature display flashes) by pressing one of the two buttons, "C" (+) or "E" (-).

Each time one of the two buttons is pressed again the DESIRED temperature is adjusted by 1 °C. The DESIRED temperature will be reached within 24 hours.

If neither button is pressed, the temperature display automatically switches back after a short period (approx. 5 sec.) to the display of the ACTUAL temperature.

### DESIRED temperature means:

The temperature that has been selected for inside the wine cooler. The DESIRED temperature is indicated by flashing numbers.

**ACTUAL temperature means:**

The temperature display indicates the current temperature inside the wine cooler. The ACTUAL temperature is indicated with illuminated numbers.

## Temperature display

The temperature display can indicate several pieces of information.

During normal operation, the temperature currently present in the wine cooler. (ACTUAL temperature) is displayed.

When the temperature is being adjusted a flashing display indicates the wine cooler temperature currently set (DESIRED temperature).

## Switching the appliance off

The wine cooler can be switched off independently of the freezer compartment. By switching off the freezer compartment you also switch off the wine cooler. To switch off the wine cooler, hold down the On/Off button (B) for the wine cooler for a count of 5 Sec. To switch off the appliance hold down the On/Off button (G) for approx.5 seconds. This will result in a count down from "3" to "1" taking place in the temperature display. On reaching "1" the appliance will switch off. The temperature display will go off.

# Using the wine cooler

## Wine cooler

To obtain the best performance the temperature can be adjusted between +6 and + 16°C.

This compartment is ideal for storing and refining red or white wines for long periods.

**Lay the bottles down** in such a way that the corks do not dry.

**Keep the wine in the dark.** The door is anti-UV darkened double glazed glass to protect the wine from the light in case the appliance is located in a well-lit place.

**Handle the bottles with care,** to avoid agitating the wine.

**Follow the recommendations** and advice received at the time of purchase or given in the technical documentation regarding the quality, duration and optimum storage temperature for the wine.

### Air circulation

Do not cover the shelves with any protective material, such as paper, cardboard or plastic, which may obstruct the air circulation through them.

Do not place the bottles at directly against the back wall of the compartment which will obstruct the air circulation through them.

## Movable shelves

The shelves can be inclined between the two guides, making sure that the smallest pins are properly inserted in the upper guide seat and the front part of the shelf is resting on the front guide.

Adjust the wooden shelves as follows:

The short shelf can be placed on the two short guides at the top.

The long shelf can be placed on the three long middle guides and inclined between the last short guide at the bottom and the shelf support structure.

The shelf support structure must be placed in the bottom of the compartment.

**Important:** Only the long shelves can be inserted in the shelf support structure.

## Normal operating sounds

- You may hear faint gurgling or bubbling sounds when the refrigerant is pumped through the coils or tubing at the rear, to the cooling plate/evaporator or to the fixed freezer shelves.
- When the compressor is on, the refrigerant is being pumped round, and you will hear a whirring sound or pulsating noise from the compressor.

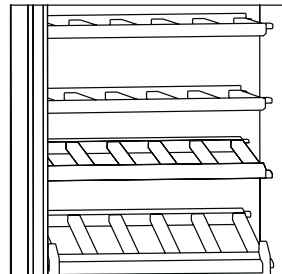

# The control panel freezer

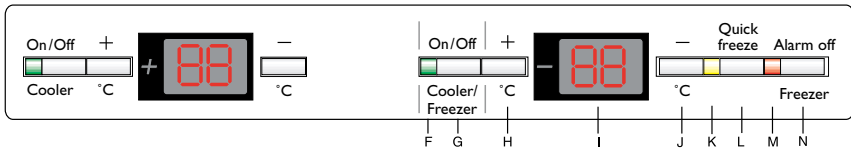

- F. Mains indicator light (green)
- G. Button On/Off for the appliance
- H. Temperature setting button (for warmer temperatures)
- I. Temperature display
- J. Temperature setting button (for colder temperatures)
- K. Quick freeze function "on" indicator (yellow)
- L. Quick freeze button
- M. Alarm off reset light
- N. Alarm off reset button

## Temperature setting buttons

The temperature is adjusted using the "H" and "J" buttons. These buttons are connected to the temperature display.

The temperature display is switched over from the display of the ACTUAL temperature (Temperature display is illuminated) to the display of the DESIRED temperature (Temperature display flashes) by pressing one of the two buttons, "H" or "J".

Each time one of the two buttons is pressed again the DESIRED temperature is adjusted by 1 °C. The DESIRED temperature must be reached within 24 hours.

If neither button is pressed, the temperature display automatically switches back after a short period (approx. 5 sec.) to the display of the ACTUAL temperature.

### DESIRED temperature means:

The temperature that has been selected for inside the freezer. The DESIRED temperature is indicated by flashing numbers.

### ACTUAL temperature means:

The temperature display indicates the current temperature inside the freezer. The ACTUAL temperature is indicated with illuminated numbers.

## Temperature display

The temperature display can indicate several pieces of information.

During normal operation, the temperature currently present in the freezer (ACTUAL temperature) is displayed.

When the temperature is being adjusted a flashing display indicates the freezer temperature currently set (DESIRED temperature).

## Starting up - setting the temperature

Plug the mains plug into the mains socket.

Press ON/OFF button (G) for the functioning of the whole appliance. The green mains pilot indicator illuminates. The alarm light flashes until the temperature is reached. The buzzer sounds.

Pressing button "N" stops the buzzer.

Press either the H" or "J" button. The temperature display switches over and the DESIRED temperature currently set flashes on the temperature display.

Set the required temperature by pressing the "H" or "J" buttons (see section "Temperature setting buttons"). The temperature display will immediately show the changed setting. Each time the button is pressed the temperature is adjusted by 1 °C.

From a food safety point of view -18 °C should be considered sufficiently cold for storing food in the freezer.

The alarm light goes off, when the set temperature is reached.

## Quick freeze

The Quick freeze function accelerates the freezing of fresh food and, at the same time, protects foodstuffs already stored from undesirable warming.

The Quick freeze function is switched on by pressing the Quick freeze button. The yellow light illuminates.

If the Quick freeze function is not ended manually, the appliance will switch off the Quick freeze function after 52 hours. The yellow light goes out.

The Quick freeze function can be ended manually at any time by pressing the Quick freeze button again.

The yellow light goes out.

## Alarm reset button

In the event of an abnormal temperature rise inside the freezer (e.g. power cut) warning light (M) will start to flash and a buzzer will sound.

After the temperature has returned to normal, the warning light (M) will continue to flash, although the buzzer has stopped.

When the alarm button is pushed, the warmest temperature reached in the compartment flashes on the indicator.

## Switching the appliance off

**By switching off the freezer compartment you also switch off the Wine Cooler.**

To switch off the appliance hold down the On/Off button (G) for approx. 5 seconds. This will result in a count down from "3" to "1" taking place in the temperature display. On reaching "1" the appliance will switch off. The temperature display will go off.

### **Note:**

The appliance cannot be switched on or off if unplugged, or if there is no power being supplied to it. Following connection to the mains power supply, the appliance returns to the same operating state as before the interruption of main power.

If the appliance is not going to be used for an extended period:

Switch off the appliance, holding down the On/Off button (G) until the display goes off (see above).

Remove the main plug .

Finally, leave the doors open so as to avoid a build up of odours.

# Using the freezer

## Before use

Remove all securing tapes. Wash inside the appliance with lukewarm water and bicarbonate of soda (5 ml to 0.5 litre of water).

**Do not use soap or detergent as the smell may linger. Dry thoroughly.**

## Freezing fresh food

The 4-star compartment is suitable for the long term storage of commercially frozen food and for freezing fresh food.

To freeze fresh foods it is not necessary to move the thermostat knob from the normal setting. Push the quick freeze switch at least 3 hours before loading food.

In any 24 hours you can freeze up to 10 kg. of fresh food.

Place the food to be frozen in drawer 4 as indicated in the diagram on page 5, as this is the coldest part.

To guarantee a good operation of the appliance during normal use, the drawers should not be removed.

## Frozen food storage

When first starting-up or after a period out of use, before putting the the frozen food products in the compartment let the appliance run for at least two hours on the coldest setting, then turn the thermostat knob to the normal operating position.

Do not exceed the storage period indicated by the manufacturer.

Finally, do not open the door frequently or leave it open longer than is absolutely necessary.



### Warning

Do not put carbonated liquids, (fizzy drinks etc.), in the freezer compartment.

Ice lollies, if consumed immediately after removal from the freezer, can cause low temperature skin burns.

Do not remove items from the freezer if your hands are damp/wet, as this could cause skin abrasions or "frost/freezer burns".



### Important

In the event of a power cut the food in the freezer will not be affected if the power cut is short and if the freezer is full. Do not open the door. Should the food begin to thaw, it must be consumed quickly and must not be re-frozen.

## Thawing

Frozen food, prior to being used, can be thawed in the fridge or at room temperature depending on the time available. Small food items may even be cooked from frozen; in this case cooking will take longer.

Any frozen food which is allowed to thaw accidentally should either be eaten as soon as possible or thrown away. Alternatively, if the food is uncooked and has not been completely defrosted it can be cooked and then refrozen.

Meat, fish and fruit should be thawed in the refrigerator compartment and small pieces of meat can even be cooked while still frozen, but you must ensure that it is thoroughly cooked through.

Vegetables should be directly immersed in boiling water; ready-cooked dishes can be placed directly in the oven in their aluminium wrapping.

A microwave oven is particularly suitable for thawing any type of frozen or deep-frozen food: follow the oven instructions, particularly regarding the placement of aluminium wrapping or containers in the oven.

**Defrosted cooked food must never be refrozen.**

## How to make ice cubes

The appliance is provided with a tray for making ice cubes.

Fill the tray(s) 3/4 full to give the ice space to expand and place them in the freezer compartment.

To release the ice cubes simply give the tray a slight twist.

Do not use sharp or metallic instruments to remove the trays from the freezer.

## Cold accumulators

Two cold accumulators are supplied in the freezer; these increase the length of time the food will keep in the event of a power failure or breakdown.

They must be placed in the top drawer.





# Hints and tips

## Food storage

- To obtain the best results from your appliance, neither hot foods nor liquids which may evaporate, should be placed in the larder compartment.
- Keep the time between buying chilled food and placing it in your fridge as short as possible.
- Do not push food together too much, try to allow air to circulate around each item.
- Do not store food uncovered.
- Remove suspect food from your refrigerator and clean, refer to 'Maintenance and Cleaning'.
- Ensure that food placed in the freezer is dated and labelled and used in date order to ensure that food is consumed at its best.
- Avoid buying frozen food if you cannot store it straight away. The use of an insulated container is advisable. When you arrive home place the frozen food in the freezer immediately.
- The symbols on the drawers show different types of frozen goods. The numbers indicate storage times in months for the appropriate types of frozen goods. Whether the upper or lower value of the indicated storage time is valid depends on the quality of the foods and pre-freezing before freezing.

## Energy saving advice

- Do not install the cabinet close to sources of heat, i.e. boiler or radiator.
- Locate the appliance in a cool well ventilated room and make sure that the air openings of the cabinet are not obstructed.
- Avoid unnecessary frosting in the cabinet by packing all foodstuffs into airtight packages before placing them in the freezer.
- Always leave warm food to cool down to room temperature before placing in the freezer.
- Food which is to be frozen (when cool) should be placed in the fridge before being transferred to the freezer.
- Try to avoid keeping the door open for long periods, or opening the door too frequently as warm air will enter the cabinet, and cause the compressor to switch on unnecessarily often.
- Ensure there are no obstructions preventing the door from closing properly.

## In the event of a power failure

If there is a power failure during the storage of frozen foods, keep the door closed. If the temperature within your freezer should rise do not refreeze the food without checking it's condition. The following guidelines should assist you.

### **Ice Cream:**

Once thawed should be discarded.

### **Fruit and Vegetables:**

If soft should be cooked and used up.

### **Bread and Cakes:**

Can be refrozen without danger.

### **Shellfish:**

Should be refrigerated and used up quickly.

### **Cooked Dishes:**

i.e. casseroles, should be refrigerated and used up.

### **Large Pieces of Meat:**

Can be re-frozen providing there are ice crystals remaining within them.

### **Small Joints:**

Should be cooked and then re-frozen as cooked dishes.

### **Chicken:**

Should be cooked and re-frozen as a fresh dish.

# Maintenance and cleaning

Before any maintenance or cleaning work is carried out, **DISCONNECT** the appliance from the **ELECTRICITY** supply.

## Internal cleaning

Clean the inside and accessories with warm water and bicarbonate of soda (5ml to 0.5 litre of water). Rinse and dry thoroughly.



**NEVER USE DETERGENTS, ABRASIVE POWDERS, HIGHLY PERFUMED CLEANING PRODUCTS OR WAX POLISHES, TO CLEAN THE INTERIOR AS THESE WILL DAMAGE THE SURFACE AND LEAVE A STRONG ODOUR.**

## When the appliance is not in use

When the appliance is not in use for long periods, disconnect from the electricity supply, empty all foods and clean the appliance, leaving the doors ajar to prevent unpleasant smells.

## External cleaning

Once or twice a year dust the condenser (black grill) and the compressor at the back of the appliance, with a brush or vacuum cleaner, see figure, as an accumulation of dust will affect the performance of the appliance and cause excessive electricity consumption.

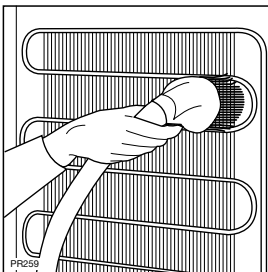

## Changing the light bulb

### Refrigerator

Should the interior light fail to work, first switch off the appliance and disconnect from the electricity supply, then replace the bulb as follows;

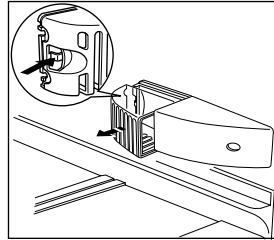

Press on the rear hook and at the same time slide the cover in the direction indicated by the arrow.

Unscrew the bulb and replace it with one of the same power (the maximum power is shown on the light diffuser) available from your nearest Service Force Centre.

Replace the light cover by sliding it into its original position.

### Wine cooler

Should the interior light fail to work, first switch off the appliance and disconnect from the electricity supply, then replace the bulb as follows;

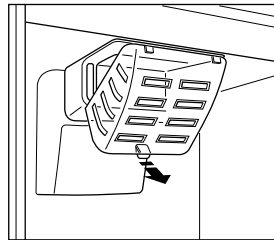

press on the rear hook and at the same time slide the cover in the direction indicated by the arrow.

Unscrew the bulb and replace it with one of the same power (the maximum power is shown on the light diffuser) available from your nearest Service Force Centre.

Replace the light cover by sliding it into its original position.

# Maintenance and cleaning

## Defrosting

### Freezer

Your appliance is frost free, which means there is no need to manually defrost your appliance as this will be carried out automatically.

### Refrigerator

The refrigerator automatically defrosts every time the compressor stops. The water is discharged, via the pipe, into a tray located at the back of the appliance above the compressor, where it evaporates.

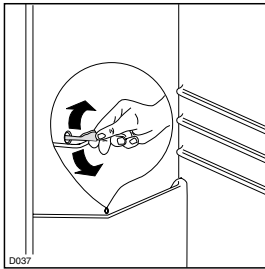

### Important

To avoid defrost water overflowing into the fridge, periodically clean the water discharge hole in the centre of the V shaped drip collector at the back of the refrigerator compartment behind the fruit and vegetable drawer. Use the defrost cleaner provided which you will find already inserted into the discharge hole.

Remember to wash the defrost cleaner in hot soapy water at regular intervals. Dry thoroughly before replacing.

# Something not working

Certain problems are due to a lack of simple maintenance or oversights, which can be solved easily without calling out an engineer. Please carry out the following checks before contacting the extended warranty administrators see Repairs - After Sales Service.

**IMPORTANT:** If you call out an engineer to a fault listed below, or to repair a fault caused by incorrect use or installation, a charge will be made even if the appliance is under guarantee.

Symptom	Cause	Solution
<ul style="list-style-type: none"> <li>It is too warm in the refrigerator.</li> </ul>	<ul style="list-style-type: none"> <li>Thermostatic control can be set incorrectly.</li> <li>If products are not cold enough or placed incorrectly.</li> <li>The door does not close tightly or it is not shut properly.</li> </ul>	<ul style="list-style-type: none"> <li>Set the thermostat knob to higher position.</li> <li>Place the products to the appropriate place.</li> <li>Check if the door closes well and the gasket is undamaged and clean.</li> </ul>
<ul style="list-style-type: none"> <li>It is too warm in the freezer.</li> </ul>	<ul style="list-style-type: none"> <li>Thermostatic control can be set incorrectly.</li> <li>The door does not close tightly or it is not shut properly.</li> <li>Products in big quantity to be frozen were put in.</li> <li>Products to be frozen are placed too closely to each other.</li> </ul>	<ul style="list-style-type: none"> <li>Set the thermostat knob to higher position.</li> <li>Check if the door closes well and the gasket is undamaged and clean.</li> <li>Wait some hours and then check the temperature again.</li> <li>Place the products in a way so that cold air could circulate among them.</li> </ul>
<ul style="list-style-type: none"> <li>Water flows at the back plate of the refrigerator.</li> <li>Water flows into the chamber.</li> <li>Water flows onto the floor.</li> </ul>	<ul style="list-style-type: none"> <li>It is normal. During automatic defrosting frost melts on the back plate.</li> <li>The outlet of the chamber can be clogged up.</li> <li>Products placed in can prevent water from flowing into the collector.</li> <li>The melting water does not flow into the evaporative tray above the compressor.</li> </ul>	<ul style="list-style-type: none"> <li>Clean the outlet.</li> <li>Replace the products so that they can not touch the back plate directly.</li> <li>Put the melting water outlet to the evaporative tray.</li> </ul>
<ul style="list-style-type: none"> <li>There are too much frost and ice.</li> </ul>	<ul style="list-style-type: none"> <li>Products are not wrapped properly.</li> <li>Doors are not shut properly or do not close tightly.</li> <li>The thermostatic control can be set incorrectly.</li> </ul>	<ul style="list-style-type: none"> <li>Wrap the products better.</li> <li>Check if the doors close well and the gaskets are undamaged and clean.</li> <li>Set the thermostat knob to a position that gives higher temperature.</li> </ul>
<ul style="list-style-type: none"> <li>The compressor operates continually.</li> </ul>	<ul style="list-style-type: none"> <li>The thermostatic control is set incorrectly.</li> <li>Doors are not shut properly or do not close tightly.</li> <li>Products in big quantity to be frozen were put in.</li> <li>Too warm food was put in.</li> <li>The appliance is in too warm place.</li> </ul>	<ul style="list-style-type: none"> <li>Set the thermostat knob to a position that gives higher temperature.</li> <li>Check if the doors close well and the gaskets are undamaged and clean.</li> <li>Wait some hours and then check the temperature again.</li> <li>Put food at max. room temperature.</li> <li>Try to reduce the temperature in the room where the appliance stands.</li> </ul>
<ul style="list-style-type: none"> <li>The appliance does not work at all. Neither cooling, nor lighting works.</li> </ul>	<ul style="list-style-type: none"> <li>Plug is not connected to the mains socket properly.</li> <li>The fuse burnt out.</li> <li>The thermostatic control is not on.</li> <li>There is no voltage in the mains socket. (Try to connect another appliance into it.)</li> </ul>	<ul style="list-style-type: none"> <li>Connect the mains plug properly.</li> <li>Change the fuse.</li> <li>Start the appliance according to instructions in chapter 'Putting it into use'.</li> <li>Call an electrician.</li> </ul>
<ul style="list-style-type: none"> <li>The appliance is noisy.</li> </ul>	<ul style="list-style-type: none"> <li>The appliance is not supported properly.</li> </ul>	<ul style="list-style-type: none"> <li>Check if the appliance stands stable (all the four feet should be on the floor).</li> </ul>

In as much as the advice does not lead to result, call the nearest brand-mark service.

# Repairs - after sales service

In the unlikely event of your appliance requiring service, or if you wish to purchase spare parts, please contact our extended warranty administrators by telephoning:

**0870 010 7887**

They will give you details for your local Service Force Centre.

Before calling out an engineer, please ensure you have read the details under the heading "Something Not Working".

When you contact your local Service Force Centre you will need to give the following details:

1. Your name, address and post code
2. Your telephone number
3. Clear and concise details of fault
4. The purchase date found on your receipt.
5. The model and serial number of the appliance (found on the rating plate - see picture on page 5)

So that you always have these numbers at hand, we recommend you to make a note of them here:

Mod. : .....

PNC : .....

S.N. : .....

**Your Wine Cooler Fridge Freezer is covered by a 3 year parts and labour guarantee (see separate details given at point of sale). Please retain your purchase receipt safely for the service engineer to verify the purchase details.**

## Spare parts



Always insist on genuine spare parts.

An authorised service engineer should service this product, and only genuine spare parts should be used.

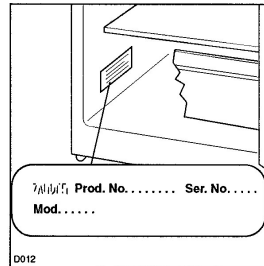
Under no circumstances should you attempt to repair the machine yourself. Repairs carried out by inexperienced persons may cause injury or serious malfunctioning. Contact your local Service Force Centre.



# Installation

-  It is dangerous to alter the specifications or attempt to modify this product in any way.
-  Care must be taken to ensure that the appliance does not stand on the electrical supply cable.
-  Any electrical work required to install this appliance should be carried out by a qualified electrician or competent person.

## Technical specifications

Dimensions	Width Height Depth	1090 mm 1855 mm 547 mm
Power supply voltage		230-240V/50Hz
Rated current		1.1 A + 1.1 A
Gross capacity	Refrigerator Wine cooler Freezer	332 l 164 l 91 l
Net capacity	Refrigerator Wine cooler Freezer	330 l 162 l 78 l
Freezing capacity		10 kg/24 h
Energy consumption		1,345 kWh/24h 491 kWh/year
Energy class, according to EU standards		A
Rising time		25 h
Noise Lc		38 dB
Weight		129 kg
Number of compressors		2



