



MF68-00258A

# DIGITAL SATELLITE RECEIVER



**DSR 9500AX / 9500AY / 9500AZ  
DSR 9510X / 9510Y / 9510Z**

# Instructions for use

---



REV. 1.4

**DIGITAL SATELLITE RECEIVER**

# SAFETY INSTRUCTIONS

This STB has been manufactured to satisfy international safety standards. Please read the following recommended safety precautions carefully.

- MAINS SUPPLY:** AC 100-240V ~, 50/60Hz
- OVERLOADING:** Do not overload wall outlets, extension cords or adapters as this can result in fire or electrical shock.
- LIQUIDS:** Keep liquids away from the STB.
- CLEANING:** Before cleaning, disconnect the STB from the wall socket. Use a cloth lightly dampened with water(no solvents) to clean the exterior.
- VENTILATION:** Do not block the STB ventilation holes. Ensure that free airflow is maintained around the STB. Never store the STB where it is exposed to direct sunlight or near heating equipment e.g. a radiator.  
Never stack other electronic equipment on top of the STB.  
Place the STB at least 30mm from the wall.
- ATTACHMENTS:** Do not use any attachment that is not recommended by the manufacturer; it may cause a hazard or damage the equipment.
- CONNECTION TO THE SATELLITE DISH LNB:**  
The LNB connector cable has voltage in its center core. It is therefore recommended that the STB be disconnected from the mains power before connecting or disconnecting this cable.  
**FAILURE TO DO SO COULD DAMAGE THE LNB.**
- SERVICING:** Do not attempt to service this product yourself. Any attempt to do so will make the warranty invalid. Refer all servicing to a qualified service agent.
- LIGHTNING:** If the STB is installed in an area subject to intense lightning activity, protection devices for the STB mains connector and modem telephone line are essential.  
The individual manufacturer's instruction for safeguarding other equipment, such as TV set, Hi-Fi, etc., connected to the STB must also be followed during lightning storms.
- GROUNDING:** The ground of the LNB cable must be directly connected to the system ground for the satellite dish.  
The grounding system must comply with local regulations

*Note :* Dispose the used batteries at designated place for environment protection

# CONTENT

<b>Safety Instructions</b> . . . . .	1
<b>General Features</b> . . . . .	3
<b>Connecting Your STB</b> . . . . .	4
<b>Description</b> . . . . .	6
Front Panel . . . . .	6
Rear Panel . . . . .	7
Remote Control Unit . . . . .	8
<b>Basic Functions</b> . . . . .	10
<b>Operating The Receiver</b> . . . . .	15
<b>Main Menu</b> . . . . .	15
<b>1. Installation</b> . . . . .	15
1.1 LNB Setting . . . . .	16
1.2 Positioner Setting . . . . .	16
1.2.1 User Mode . . . . .	17
1.2.2 Installer Mode . . . . .	18
1.3 Solarsat Setting . . . . .	18
1.4 Auto Scanning . . . . .	18
1.5 Manual Scanning . . . . .	19
1.6 SMATV Scanning . . . . .	20
1.7 Reset to Factory Defaults . . . . .	20
<b>2. Channel Organising</b> . . . . .	21
2.1 Delete Satellite . . . . .	21
2.2 Delete Transponder . . . . .	21
2.3 Delete Channel . . . . .	22
2.4 Delete All Channel . . . . .	22
2.5 Delete Scrambled Channels . . . . .	22
2.6 Favorite Channel . . . . .	22
2.7 Move & Edit Channel . . . . .	23
<b>3. Parental Lock</b> . . . . .	24
3.1 Set Channel Lock . . . . .	24
3.2 Change PIN Code . . . . .	25
<b>4. System Setup</b> . . . . .	26
4.1 Language Selection . . . . .	26
4.2 OSD Setting . . . . .	26
4.3 Media Settings . . . . .	27
4.4 Modem Setting . . . . .	27
4.5 Time &Timer Setting . . . . .	27
4.6 System Information . . . . .	28
4.7 Software Upgrade . . . . .	28
4.8 Copy Channel Data . . . . .	28
<b>5. Common Interface</b> . . . . .	29
<b>6. Embedded CAS</b> . . . . .	29
<b>Troubleshooting</b> . . . . .	30
<b>Disposal</b> . . . . .	30
<b>Technical Specifications</b> . . . . .	31

# GENERAL FEATURES

## 1. USER SECTION

- ▶ 4000 PROGRAMMABLE CHANNELS
- ▶ SOFTWARE DOWNLOAD VIA SATELLITE & PC(Secured)
- ▶ ADVANCED ELECTRONIC PROGRAM GUIDE
- ▶ MULTI LANGUAGE SUPPORTED FOR OSD
- ▶ SUBTITLE & TELETEXT(OSD & VBI)SUPPORTED WITH MULTI LANGUAGE
- ▶ DiSeqC 1.2 SUPPORTED
- ▶ FULL FUNCTION INFRARED REMOTE CONTROL UNIT
- ▶ 7 SEGMENT LED DISPLAY
- ▶ AUTO AND MANUAL SCAN FACILITY
- ▶ CHANNEL ORGANIZING(PROGRAMMABLE)
- ▶ SCARTS & RCA OUTPUT
- ▶ LOW POWER CONSUMPTION
- ▶ 9 FAVORITE LISTS
- ▶ AUTO UPDATED EPG
- ▶ PASS LOOP FOR RGB SIGNAL

## 2. TUNER SECTION

- ▶ 950~2150 MHz WIDE BAND TUNER
- ▶ IF OUTPUT WITH DC PASS LOOP FOR ANALOG RECEIVER
- ▶ SUPPORTING DiSeqC 1.2 VERSION
- ▶ 13V/18V SWITCHING
- ▶ 22KHz CONTINUOUS TONE CONTROL

## 3. VIDEO SECTION

- ▶ DVB-S COMPLIANT
- ▶ MPEG-2 VIDEO(MP@ML)
- ▶ 2~45 MS/s SYMBOL RATE
- ▶ COMPATIBLE FOR BOTH SCPC/MCPC
- ▶ SUPPORTS ASPECT RATIO 4:3(NORMAL) AND 16:9(WIDE SCREEN)
- ▶ MODULATOR OUTPUT

## 4. AUDIO SECTION

- ▶ MPEG 1 AUDIO LAYER I & II
- ▶ MONO, DUAL, STEREO AND JOINT STEREO AUDIO MODE
- ▶ 32, 44.1 AND 48 kHz SAMPLING FREQUENCIES
- ▶ VOLUME CONTROL AND MUTE FUNCTION THROUGH REMOTE CONTROL UNIT
- ▶ SPDIF DIGITAL AUDIO OUTPUT

# CONNECTING YOUR "STB"

## 1. LOCATION OF THE RECEIVER

Your STB should be placed under proper ventilation.

Don't put in completely enclosed cabinet that will restrict the flow of air, resulting in overheating.

The location should be safeguarded from direct sunlight, excess moisture, rough handling or household pets.

Avoid stacking other electronic components on the top of the receiver.

The location should be safely accessible by the cable from your antenna system.

## 2. CONNECTING THE RECEIVER WITH DISH SYSTEM

After installing your antenna system, connect the coaxial cable from the LNB of your antenna to "LNB" terminal marked at the rear of the STB.

All cable connectors should be finger tightened; do not use any kind of wrench while tightening connectors. The cable should be 75ohm impedance coaxial twisted at the end with an "F" type connector.

## 3. CONNECTING THE RECEIVER TO TV

To connect the receiver with your television, you can use four methods; via SCART cable, RF cable, RCA cable or S-VHS cable. S-VHS provides the better screen quality.

Connect the RF cable to the terminal marked "TV" at the rear panel of STB and its other end to the TV RF input socket.

In the case of connecting your TV through SCART cable, connect the SCART connector marked TV to the respective SCART port on the TV.

## 4. CONNECTING YOUR ANALOG RECEIVER

To facilitate the user using analog receiver to view analog channels, STB has been provided with a loop through terminal marked as "LOOP".

Connect the coaxial cable from this terminal to the IF input terminal of your analog receiver. Now by keeping the STB in standby, you will be able to tune and view analog channels from your analog receiver.

## 5. CONNECTING YOUR VCR

To connect a VCR or DVD player, the STB has been provided with SCART at the rear marked "AV2".

Using a SCART connector, the VCR or DVD player can be connected to the receiver.

*Note* : This is supported by standby.

## 6. CONNECTING EXTERNAL AUDIO / HI-FI SYSTEM

To connect any external Audio Hi-Fi system, the receiver has been provided with two RCA connectors at the back of the receiver, marked with AUDIO L and R respectively to connect the left and right Audio.

### 7. CONNECTING DIGITAL AUDIO SYSTEM

Connect a fiber optic cable between Optical SPDIF on the receiver and Optical SPDIF on the Digital Audio System.

### 8. INSERTING SMARTCARDS FOR CAS SERVICES

In order to view a scrambled service, you need to have the appropriate CAM (Conditional Access Module) and a valid smartcard.

*Note* : Insert the Smartcard with the gold coloured chip facing downwards.

### 9. INSERTING COMMON INTERFACE CAM AND SMARTCARD

The STB supports Common Interface CAMs under DVB specification.  
The CI CAMs include a built-in smart card reader.

- Insert the smart card into the CAM gently with the gold colored chip upwards
- Slide in the CAM gently inside the slot so that it sits in the socket tightly.
- To remove the CAM push the button provided by the side of the CAM slot.  
The CAM will be ejected from the socket.

*Note* : The following Common Interface CAMs are available now:

IRDETO, CONAX, CRYPTOWORKS, VIACCESS, NAGRAVISION, SECA, Etc.

Connecting Figure

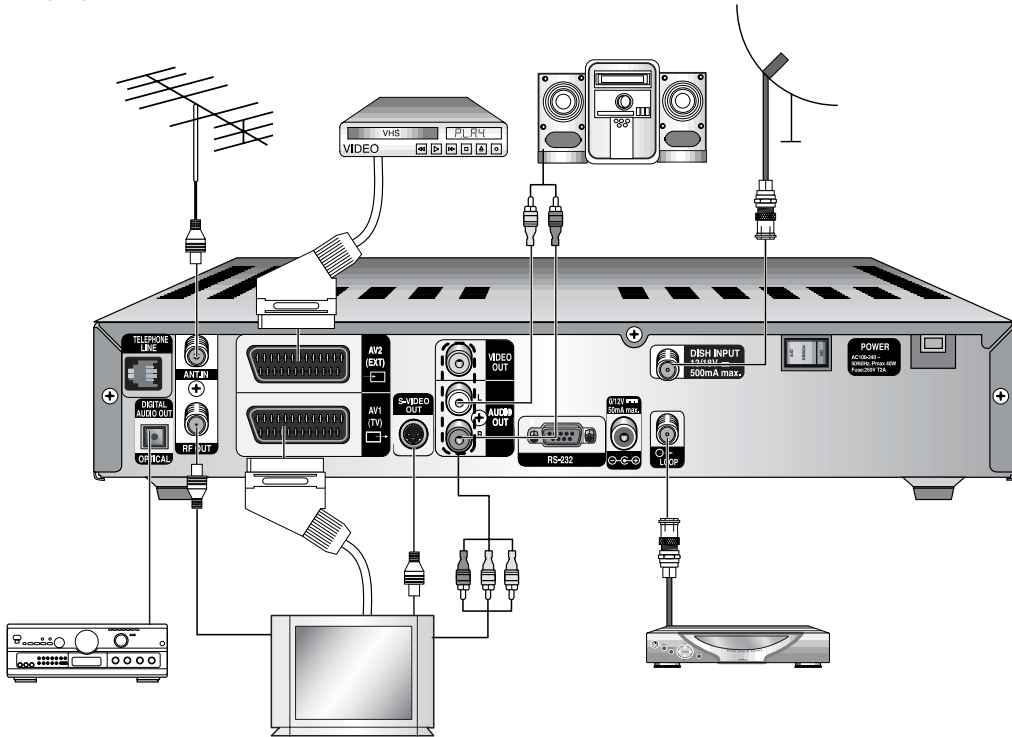

# DESCRIPTION

## Front Panel

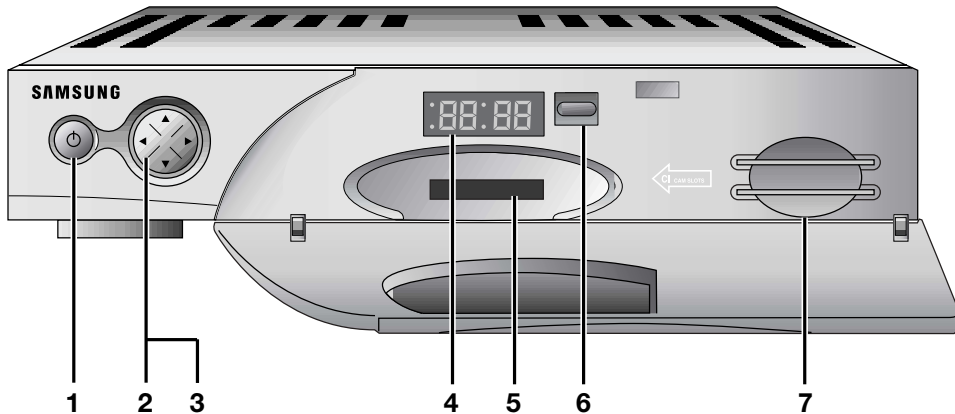

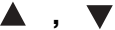
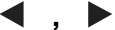
1.  This key is for turning the receiver on and Standby.
2.  These keys are for changing the channels.
3.  These keys are for increasing and decreasing the volume level manually.
4. **7 Segment Display** This LED display will show the current channel number. While the receiver is in Standby mode, the display will show the current time.
5. **CA Module Slot** In the slot you can use a CA module from a service provider of your own choice.  
(For models DSR 9500AY, DSR 9510Y, DSR 9500AZ, DSR 9510Z)
6. **Infrared Sensor** This is to receive the IR commands from the Remote Control Unit.
7. **Smart Card Slot** The STB is equipped with a built in decoder for the CAS encryption.  
**DSR 9500AX, DSR 9500AY, DSR 9510Y and DSR 9510X** models are valid for the Viaccess and CONAX smart card encryption at all. Only a CONAX smart card can be used for **DSR 9500AZ** and **DSR 9510Z**.

*Note* : CA modules and smart cards are only distributed by service Providers and special distributors, not by SAMSUNG.



## Rear Panel

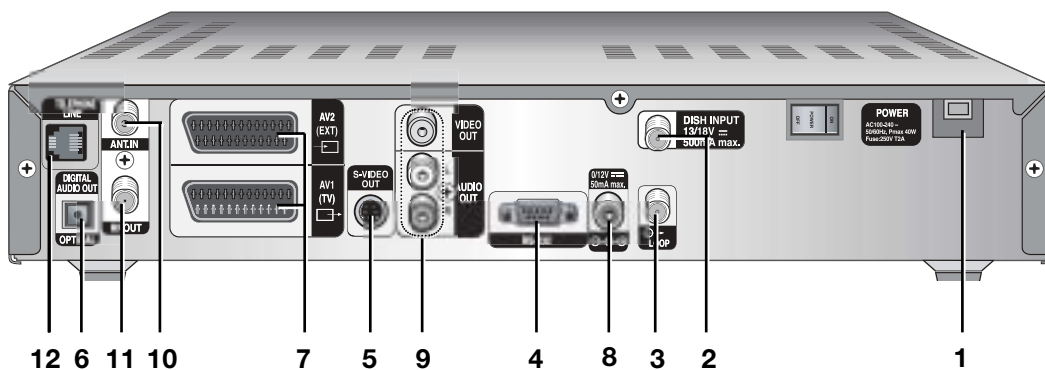





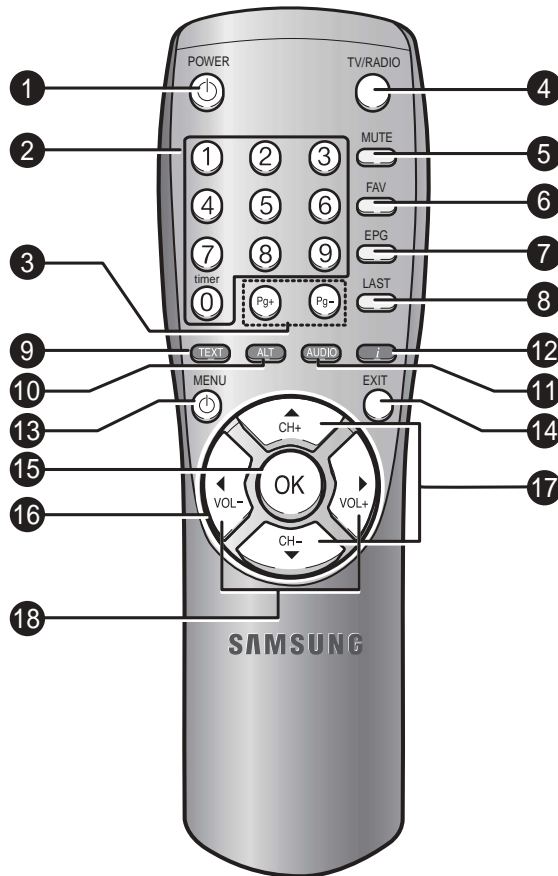



- 1. AC MAINS** This is to plug in the AC mains power cord. The input AC voltage range is 100V to 240V, 50Hz/60Hz supply.
- 2. LNB** This port is to connect the coaxial cable from LNB of your dish. The IF input is provided through this port and the input frequency range is 950-2150 MHz. Also the voltage switching 13V and 18V is passed through this port.
- 3. LOOP** To enable the connection of an Analog receiver, The receiver is provided with this 'LOOP' port.
- 4. RS 232 DATA PORT** This is for connecting your receiver to a computer for reading and loading data information. This is for the external modem for future purposes only, too.
- 5. S-VHS** This is for connecting STB to your TV by using S-VHS cable.
- 6. SPDIF** Output for connection to a digital amplifier.
- 7. AV SCARTS** This is for connecting to your AV scarts for TV & VCR or DVD player.
- 8. 0/12V** This is for connecting to an external LNB switch.
- 9. VIDEO, AUDIO R/L** These RCA connectors are for connecting any external video and audio.
- 10. ANT.IN** This is for connecting your local RF channels to your TV through Loop.
- 11. TV** This is for connecting to your TV via RF cable.
- 12. TELEPHONE LINE** The telephone lead(labeled in the diagram above) is intended for connection to standard NORDIC telephone lines. (Only 3models can be used for **DSR 9510X**, **DSR 9510Y** and **DSR 9510Z**.)

## Remote Control Unit



*Note* : When inserting batteries, make sure that the polarity(+/-) is correct.

- 1. POWER (⏻)** This is for switching the receiver ON/STANDBY mode.
- 2. 0-9 Numerical keys (0~9)**  
These keys are to enter numeric values and to select the channel directly by entering its number.
- 3. Pg+/Pg- (⏮, ⏭)** These keys are for moving up or down pages on the menu.
- 4. TV/RADIO** This key is for toggling between the TV channel and Radio channel.
- 5. MUTE** This key is for toggling between normal & muted audio.

- 6. FAV** Use the key to switch between favorite lists.
- 7. EPG** Electronic Program Guide button displays the TV/Radio Program guide.
- 8. LAST** This key is for calling up directly whatever channel you were watching from the list.
- 9. TEXT(GREEN)**  
 This key is for selecting the subtitle mode. This button functions same as the GREEN button on the menu. Press once and subtitle appears. You can select the language you want using the channel +/- keys. Press twice it. Then Teletext will be displayed on TV Screen without operating anything on TV. This Teletext can be displayed on TV which doesn't support Teletext functionality. Press three times it. Then Teletext will be available on TV. It means that Teletext can be chosen by TV with TV RCU.
- 10. ALT(YELLOW)**  
 This key is for selecting the soundtrack list for the current service. This button functions same as the YELLOW button on the menu. Press once and sound track appears. Press twice and video track appears. The sound and video track services are not provided for every channel and depend on the conditions the operator is in.
- 11. AUDIO(BLUE)**  
 This key is for changing the Audio to the left, right or both channels, This button functions same as the BLUE button on the menu.
- 12. INFORMATION (RED) ()** This key is for displaying the programe information box in the screen. This button functions same as the RED button on the menu. Press once and you can get simple information on the program. Press twice and you can get detailed information on the channel in text box.
- 13. MENU** This key is for opening up the menu or returning to the previous menu.
- 14. EXIT** This key is for exiting a menu or returning to the previous menu.
- 15. OK()** This key is for entering and confirming any data to the receiver in the menu system. This key is for selecting the item. Press while viewing TV and a list of channels is displayed.
- 16. ** These keys are for moving the highlight bar for selecting options on the menu, and this button is used to change channels and increase or decrease the volume.
- 17. CH+/CH-()** These keys are for changing channels.
- 18. VOL+/VOL-()** These keys are for increasing or decreasing the volume. These keys are for moving up or down pages on the channel list.

# BASIC FUNCTIONS





## 1. Display Screen

Before you can view the television program, you must perform the installation.

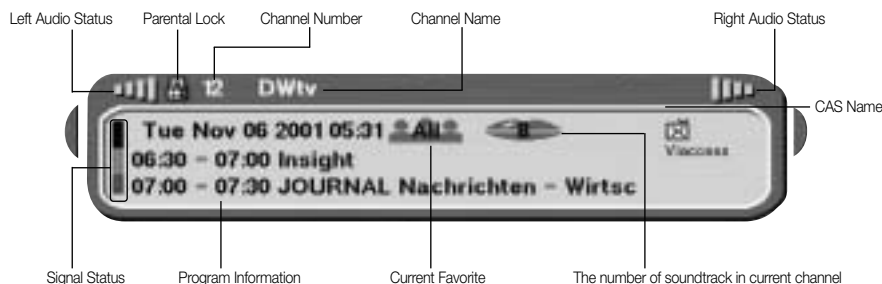
Therefore you will see only menu images at first.

After the television channels have been programmed, you will see the following picture(banner) each time you switch channels:



- Press the **RED** () key in view mode.
- Select the channel by pressing **NUMERICAL** (~) keys or  /  keys and select **TV/RADIO** key to move to TV or Radio channel.



You will also see this picture each time you change channels.

When you press **TV/RADIO** key on the Remote Control Unit, **TV** and **RADIO** program are toggled.

### Detailed program information

- Press the **RED** () key twice while you are viewing a program.

First you will see the banner described above.





After the **RED** () key is pressed in the second time, detailed information for current program can be displayed on another banner, if there is more information. When this information is more than one page,  /  can be used for page up and down.

*Note* : This service depends on service provider.



## 2. Volume Control



To control the volume level :



- Press  /  keys to adjust the volume level.
- Press **MUTE** key to turn to silence mode.
- Press **MUTE** key again or  /  keys in order to cancel the mute function.

### 3. Select Soundtrack

- Press **YELLOW** (**ALT**) key to see the soundtrack list.
- Press / and  key to select one.



### 4. Select Videotrack





- Press **YELLOW** (**ALT**) key twice to see the videotrack list.
- Press / and  key to select one.



### 5. Service List

- Press  key to while you are viewing a program.
- Select list by pressing **TV/RADIO** or **FAV** key.

The icon  behind the channel name symbolises scrambled channel, and the  icon behind the channel name shows parental lock channel.

- Select the channel by pressing /, /.
- Press  key to watch that channel.



The colour key corresponds the following service list.

- **GREEN** (**TEXT**) key - **Favorites**
- **YELLOW** (**ALT**) key - **Alphabetical**
- **BLUE** (**AUDIO**) key - **Provider**
- **RED** (**i**) key - **Transponder**

### 5.1 Service Favorites

- Press the **GREEN (TEXT)** key on the control unit to select the Favorites list.
- Press the **GREEN (TEXT)** key to switch between favorite list and channel list.
- Use the / , / keys to select a favorite group that you want.



### 5.2 Service Alphabetical

- Press the **YELLOW (ALT)** key on the remote control unit to select the Alphabetical list.
- Press the **YELLOW (ALT)** key to switch between alphabet list and channel list.
- Use the / , / keys to select a Alphabetical group that you want.



### 5.3 Service Provider

- Press the **BLUE (AUDIO)** key on the remote control unit to select the Provider list.
- Press the **BLUE (AUDIO)** key to switch between Provider list and channel list.
- Use the / , / keys to select a Provider group that you want.



### 5.4 Service Transponder

- Press the **RED (i)** key on the remote control unit to select the Transponder list.
- Press the **RED (i)** key to switch between Transponder list and channel list.
- Use the / , / keys to select a Transponder group that you want.



## 6. Program Information

### EPG-Electronic Program Guide

The electronic program guide gives you information for the channels.

**Note :** 1. This service depends on service provider.  
 2. After receiver recognized the GMT-time from the signal which takes few seconds, it can display correct EPG information.

- Press **EPG** key while you are viewing a program.



This function is displayed on the screen by using only time. You will see "**EPG**" in the LED display of the receiver.

- **GREEN** (**TEXT**) key: Green key is for moving back to the previous date.
- **YELLOW** (**ALT**) key: Yellow key is for moving to the next coming date.
- **BLUE** (**AUDIO**) key can be used for page up, if there is more information than one page.
- **RED** (**i**) key can be used for page down, if there is more information than one page.

Time interval can be adjusted by press keys as followings on EPG screen:

**1 key:** 1 hour and 30 minutes    **2 key:** 30 minutes    **3 key:** 15 minutes

With the **TV/RADIO** or **FAV** key you can browse among the various programs lists.

- Select the channel by pressing /, /, / keys and press key to watch this channel.

## 7. Subtitle

When the current broadcasting program provides subtitle, press the **GREEN** (**TEXT**) key to see the current subtitle language list. If Subtitle is available on current program, [S] is displayed on the banner after changing program( channel) or pressing **RED** (**i**) key.



To change the subtitle language:



- Press the **GREEN** (**TEXT**) key to see the subtitle language List.
- Use the / keys to select a subtitle language you want.
- Press the key and then the subtitle language you want is displayed.

The menu display is carefully created and user friendly to assure the easy operation of the receiver by the user.

## 8. Teletext OSD

When the current broadcasting program provides Teletext OSD, press the **GREEN (TEXT)** key twice to see the current Teletext OSD list.

### To change the Teletext OSD:



- Use the  /  keys to select a **Teletext OSD** you want.
- Press the  key and then the **Teletext OSD** you want is displayed on the screen.



## 9. Teletext VBI

When the current broadcasting program provides **Teletext VBI**, press the **GREEN (TEXT)** key three times to see the current Teletext VBI list.

### To change the Teletext VBI:

- Use the  /  keys to select a **Teletext VBI** you want.
- Press the  key and then the **Teletext VBI** you want is displayed on the screen.



## 10. Audio Mode

You can choose a mode among left, right or stereo using the **AUDIO** key.

### To change the audio mode:

- Press the **AUDIO** key to select the left, right or stereo.
- Press the **EXIT** key to save and escape from this menu.





# OPERATING THE RECEIVER

## Main Menu

After installing your antenna system and STB with appropriate connectors.

- Plug in the AC main power and switch on the receiver.
- Press **MENU** key to bring up the main menu.  
The **LED** display will show "**MENU**".

**The following on screen display will appear:**

The sub menu topics will be displayed.

For the sub-menus 1, 2 and 3 you need the PIN Code.

- You must follow the help message at the bottom of the screen!

**Before you begin with the "Installation" menu, you should check in the 4th menu "System Setup" whether all the information there is applicable for you.**



## 1. Installation

The menu provides settings for customizing, adding new services and displaying the status of the receiver.

- Select "**Installation**" in the main menu mode to select the sub menu.
- Enter the **PIN Code**.

If you have not entered your own PIN Code then the PIN Code **0000** applies, which was set at the factory.



## 1.1 LNB Setting

You can select the satellite and LNB setting conditions to execute channel search and you can alter the settings for 22KHz tone. The parameters set in this menu are needed for programming the channels for the **"Auto scanning"** and **"Manual scanning"**. The necessary information can be found at your antenna and LNB brochures, or you can ask your dealer.



- Select LNB power supply **"On"**.
- Select the desired satellite name.
- Select the LNB type (frequency).
- Select the DiSEqC Mode  
(Off, DiSEqC A, DiSEqC B, DiSEqC C, DiSEqC D, Tone Burst A, Tone Burst B)

If you are using a Positioner, select this option. (**"Yes"** or **"No"**)

**22KHz:** In case you are using a dual LNB or two antennas connected to a 22KHz tone switch box, with the 22 KHz tone switch (**"On"**, **"Off"** or **"Auto"**) you can switch between both LNB or antennas.

## 1.2 Positioner Setting

If you have a DiSEqC 1.2 motorized system which is fully compatible with DiSEqC1.2, then you can take advantage of the DiSEqC 1.2 functions available.



- Select Satellite.
- Select any transponder from above satellites and check out the Frequency, Symbol Rate, FEC and Polarity.

In case problems arise, ask your dealer.

- Select from Menu Mode:









**"User"** mode : Enables control of basic positioner function recommended for beginners. General user uses **"User"** mode.

**"Installer"** mode : This is used to search for the position of a satellite manually.

### 1.2.1 User Mode

- **Select Driving Mode:**

You have an option to choose the positioner's movement type: Continuous, Step or Time.

- Position the antenna with north, south, east and west and use the  / ,  /  key to drive motor.  key drives to west,  key drives to east,  key drives to north and  key drives to south.
- If you finished driving of motor, select **"Store current Position."** and press  key, to reset new driving motor.



**Note :** The level indicated in the "Signal Status" is only for reference. The signal quality may be adequate even though the level indicated is not maximum.





- Go to Stored Position.

When the stored position is reached then screen displays **"Stop"**, you can now continue with the further operations.

- Select the Calculate Sat Positions to recalculate the satellite position and  key.

### 1.2.2 Installer Mode

After checking the positioner's state, installer should use this menu. He should set the **"Disable Limits"** before using User mode.

- Select the Drive Motor West/East and use the  /  keys to drive motor.  key drives to west and  key drives to east.
- Select **"Enable Limit"**, in order to enable **"Set Limit"**.
- Select **"Disable Limit"**, in order to disable **"Set Limit"**.
- Select **"Reset Positioner"** and  key to reset positioner.









### 1.3 Solarsat Setting

This menu is only for the Solarsat antenna.

When you press this menu, you will get this message,

**“This menu is only for the Solarsat antenna.  
If you have one-press OK, otherwise-press EXIT.”**

You can set the value according to your location.

- To set the Value of Date and Time, use the / keys to change the value.
- Use the / keys to change position.
- Use the / keys to move each filed.



### 1.4 Auto Scanning

The sub menu **“Auto Scanning”** will enable download the channels automatically from the preprogrammed satellites.

**To download channels automatically:**

You can select All/Off/Only Free option mode in each satellite.

- Off :** No Scan
- All :** Scan all the channels
- Only Free :** Scan free channels

- Press  key.

Auto Scanning menu will be displayed.

All the channels in the list from the selected satellite will be automatically downloaded.

After scanning you will see **“Your digital receiver found...”** .

Then, you should press  key to store all channels into STB.



## 1.5 Manual Scanning

To tune-in new channels and weak signals, the STB has been provided with the option "**Manual Scanning**" where the channel data can be entered by the user.

After selecting the "**5. Manual Scanning**" from the Installation Menu, the following screen will be displayed:



- Select the target satellite for manual search.
- Load a transponder.  
This option will enable the user to load any transponder from the preprogrammed list available within the receiver.

**Note :** Especially on New transponder at Load TR, this new transponder can be added into transponder list so that you can use it on Auto Scanning later, only if at least one channel is found with this new transponder. In order to save it, press  key.

- Input the frequency of the transponder you want to find.
- Input the symbol rate of the transponder you want to find.
- Select the FEC(Forward Error Correction)of the transponder you want to find.  
You can select the value of 1/2, 2/3, 3/4, 5/6, 7/8 or Auto.
- Select the polarization of the transponder you want to find.  
**(Horizontal/Vertical/Circular Left/Circular Right)**  
In the case of horizontal, 18V and in the case of vertical, 13V are output through LNB line.
- Select Scan Mode "**All**" or "**Only Free**".
- Set "**Yes**" on Network Search. You can get more channels from transponder using the homing transponder. Additionally, you can get '**Provider Name**' on the screen.
- Select PID searching "**Yes**". You can manually search by entering individual PID (Packet Identifier)(Video/Audio/PCR) values.
- After select option, press  key to start the scan process.

## 1.6 SMATV Scanning

In case that several generations use Antenna and LNB in common, search the service the from 950 to 2150MHz.

- Select Searching Type “**Automatic**” or “**Manual**”.
- Select Scan Mode “**All**” or “**Only Free**”.
- You can input alternative symbol rate from 1 to 4



**Note :** 1. When your searching type is set to Automatic during **SMATV** scanning, you have only to enter the alternative symbol rate(1~4) you want.

2. When your searching type is set to Manual during **SMATV** scanning, you must enter both frequency and symbol rate.



When you select "**Automatic**", STB will search all available channels based on symbol rates over whole frequencies. On the other hand, it will scan channels with exact information for symbol rate and frequency on "**Manual**".

## 1.7 Reset to Factory Defaults

This is to recover the Factory set values in case the user has encountered some problems after changing any values of channel data and others which may be in error.

**The screen display will be as follows:**

At the request window, if you press  key, the receiver will be reset to factory default settings automatically.

**Note :** This cause your previous settings to be deleted!

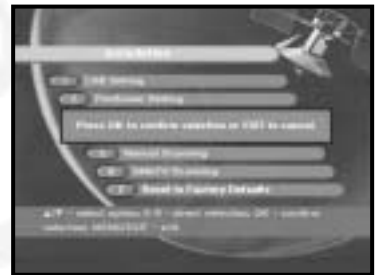

## 2. Channel Organising

The "**Channel Organising**" menu has seven functions:  
 This menu is for removing some channels from channel list which are related with designated Satellite or Transponder. And it provides making favorite list and moving channel position as you want.

- Enter the **PIN Code**.

If you have not entered your own PIN Code **0000** applies, which was set at the factory.



### 2.1 Delete Satellite

- Select the desired satellite list you want to delete by pressing **RED (i)** key.
- Press **OK** key for confirmation.

**Note :** This feature doesn't delete satellite itself but deletes the list of channels registered at the selected Satellite.



### 2.2 Delete Transponder

- Select the desired transponder list you want to delete by pressing **RED (i)** key.
- Press **OK** key for confirmation.

**Note :** This feature doesn't delete transponder itself but deletes the list of channels registered at the selected transponder.



### 2.3 Delete Channel

- Select the desired channel you want to delete by pressing **RED (i)** key.
- Press **OK** key for confirmation.



## 2.4 Delete All Channel

At the request window, press **OK** key to delete all channels and press **MENU / EXIT** to exit.

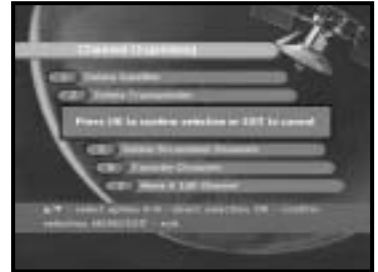

## 2.5 Delete Scrambled Channels

At the request window, press **OK** key to delete scrambled channels and press **MENU / EXIT** to exit.

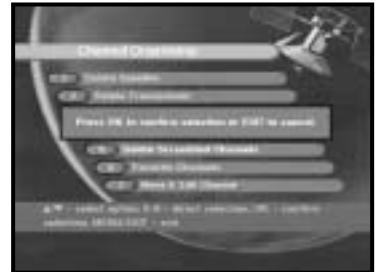

## 2.6 Favorite Channel

You can immediately register the present channel to the desired Favorite Group.

In addition, you can register a channel to multiple favorite groups.

- Select the desired Favorite Group (FAV1~FAV9) using the **FAV** key.
- Select the desired channel list using the **TV**/**RADIO** or **PG-/PG+** keys at the **TV** or **RADIO** list window.
- Press the **RED** (**i**) key and then register the selected channel at the Favorite Group.
- Then press the **OK** key for confirmation.



You can change TV list or Radio list by the **TV/RADIO** key and change favorite list by the **FAV** key.

- When you press the **TV/RADIO** key, TV list and Radio list are toggled.
- Press the **FAV** key to select another favorite list.

### To delete channels from Favorite Group:

- Select a channel list to delete with **TV**/**RADIO** or **PG-/PG+** keys.
- Press the **RED** (**i**) key to delete the selected channel from the favorite channels.



## 2.7 Move & Edit Channel

- Select the TV/RADIO list with / keys.
- Select the TV/RADIO list with / or **PG-/PG+** keys.
- Select channel by pressing the **RED** () key.
- Press the / or **PG-/PG+** keys to change the position of the channel you want, and press the key for confirmation.
- If you want to return the channel to the initial position, do not press the key but press the **BLUE** () key.



### To edit Channel Name

- Select the TV/RADIO list with / keys.
- Select a channel list to move to other location with / or **PG-/PG+** keys.
- Press **GREEN** () key. Font Table will be displayed.
- Select desired font table using the **Num.1~5** keys.
- Select desired character with / , / and then press the key to paste character to the string.



**Note :** **PG-** key : Backspace.

- Press the **MENU** key and then press the key to save the set data.

### 3. Parental Lock

This "**Parental Lock**" feature sets viewing restrictions and prevents unauthorized access to your STB through the PIN (Personal Identification Number), which is a 4 digit number. (The factory preset PIN Code : **0000**)

On selecting this menu, you will have two options: to set lock for any desired channel and to change your PIN value.

- Enter PIN Code.

If you have not entered your own PIN Code then the **PIN Code 0000** applies, which was set at the factory.



#### 3.1 Set Channel Lock

- Select the channel by pressing / , / , / .
- When you press the **TV/RADIO** key, TV list and Radio list are toggled.
- Select the channel lock by pressing **RED** () key.
- Press key for confirmation.



This will lock the channel. Whenever you need to view the channel, you will have to enter the PIN at the request window.

After entering PIN Code to able to access a parental locked channel, it will work on all parental locked channels.

It means that you can access all parental locked channels with entering PIN Code on any parental locked channel successfully.

#### To cancel the lock :

- Press **RED** () key again in order to cancel the lock.

### 3.2. Change PIN Code

To change the PIN Code, select the second option "**Change PIN Code**".

**This will take you to the following menu:**

In this option, you need to enter the current PIN Code at the first cursor, and at the second cursor enter the desired PIN Code.

To confirm, you need to enter the new PIN Code again.

Please remember the PIN Code should be a 4 digit numerical value.

THE FACTORY PRESET PIN Code : **0 0 0 0**.



## 4. System Setup

This option enables you to change the factory preset system settings as per your requirements.



### 4.1. Language Selection

The "**Language Selection**" option allows the user to select the desired language of the OSD, Soundtrack, Teletext, Subtitle or EPG.

- To accommodate user from different regions speaking different languages, OSD languages are available 19 languages.
- To select the desired language menu, press / keys to change language and press .
- The OSD Language, Soundtrack, Teletext, Subtitle, or EPG will vary according to the selected language.





## 4.2 OSD Setting

You can set the OSD transparency and the display time.

- Select OSD Transparency level.

The OSD Transparency level from 0 to 100%.

Setting is made with the numeric keys,   keys or **PG-/PG+** keys.

  keys : Setting in increment of 1%.

**PG-/PG+** keys : Setting in increment of 10%.

- Set the display duration of the information(banner) box displayed in the screen.

The time ranges from 0.5 to 60.0 seconds.

Setting is made with the numeric keys,   keys or **PG-/PG+** keys.

  keys : Adjusting in increment of 0.5sec.





**PG-/PG+** keys : Adjusting in increment of 1 sec.



## 4.3 Media Settings

You can set the various media settings you want.

Place the cursor on this sub menu and press .

- Press the  /  keys to move the sub items and press the   keys to select the option.
- Press the  key to confirm.
- Press the **MENU/EXIT** keys to exit the menu.
- Select the TV system : PAL, SECAM.
- Select the TV type according to your TV: **STANDARD** 4: 3 ratio or **WIDE SCREEN** 16 : 9 ratio type.
- Select the aspect ratio conversion : Letter box, Pan & Screen, Mixed or Full.
- Select the Video Signal Type : Composite+RGB or Composite.
- Select the RF Channel.
- Select Broadcasting System : B/G, I or D/K.

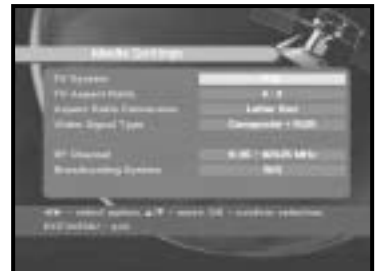

## 4.4 Modem Setting

**Note :** DSR 9510X, DSR 9510Y and DSR 9510Z are supported Internal modem & External modem at all. DSR 9500AX, DSR 9500AY and DSR 9500AZ are supported only External modem.

- **Modem Type:**

If I internal Modem is installed in DSR 9510X, DSR 9510Y and DSR 9510Z, "**Internal**" will be displayed. Otherwise, "**External**" will be displayed. Additionally, you can select it as Advanced external so that you can set parameters for your external modem.



- **Prefix:** If you are using extension line, please enter prefix number.
- **Dialing:** Please choose between Tone and Pulse.

## 4.5 Time & Timer Setting

- Place the cursor on this sub menu and press **OK**.
- Press the **PP**, **PP**, **←**, **→** keys to change the Local time in Time Zone. The local time will be changed according to your location.



GMT is referred to the standard time of Greenwich. This cannot be changed.

- Press the **←**, **→** keys to choose event repetition you want to reserve : Daily, Every Sunday, Every Monday, Every Tuesday, Every Wednesday, Every Thursday, Every Friday, Every Saturday, Once.
- Press the **Numerical (0~9)** keys to set the time you want and press the **←**, **→** keys to choose a switch time you want to reserve.
- Select TV program to set the event program by pressing **←**, **→** keys. When you press the **TV/RADIO** key, TV program and Radio program are toggled.
- Even you can set timers on Daily and Every Monday or Every Sunday, etc. The priority has the repetition event which is less. For example, when you set timers on Once and daily, "Once" will work in stead of "daily" at that day.

## 4.5 System Information

If you have to contact your service provider or a service center they might ask for information available from this menu. Place the cursor on this sub menu and press **OK** key. The following will be the on-screen display.



## 4.6 Software Upgrade

You can download and upgrade the software of this **STB** through ASTRA and Hotbird satellite when the new software is released.

During downloading don't turn off the **STB**.

If there is a new version of software to download, you are asked if you will update or not.

If you press **OK** key, the update starts right away.

In case update is impossible, you get this message

**"You can't update software!"** Or in case you don't need to update, **"You don't need to update software!"** will be displayed.

If you get information that a Transponder is changed to different one for Samsung software, you should select "User Advanced Mode" at Menu mode by using Vol-/Vol+ key.

Then you should set exact parameters for the new transponder for Samsung.



## 4.7 Copy Channel Data

If you want to copy the channel data from one receiver to another, please follow the instruction below.

Please make your own channel data, such as favorite & lock channel with your own master box.

Then take your master box when you install another box.

1. Plug on both master & slave receivers
2. Master Box(Installed Box) : Stand-by Mode
3. Slave Box(Installing Box) : Menu Mode
4. Connect 2 Boxes with RS232 serial cable  
(Both end should have male connector)
5. Select '**4. System Setup**'
6. Press '**7**' key on RCU
7. Press '**OK**' to start channel data copy



**Note :** Use this function after removing SMART CARD or CAM modules.

## 5. Common Interface

This STB is equipped with two PCMCIA slots, which enable the use of two CI-CAMS.

When a Common Interface CAM is inserted inside the PCMCIA slot, the system detects the type of the CAM automatically and display in the main menu.

On choosing this menu, you will be able to access the different options available with the type of the CAM like authorizations, pre-booking, package details etc.,



**SLOT A:** You can see the Common Interface CAM's name which has been inserted.

**SLOT B:** "**Not installed**" is displayed when there is no CAM in slot.

During inserting any CAM, you may have distorted video or audio. It doesn't mean STB is wrong.

## 6. Embedded CAS

### 1. Change PIN code:

Change the PIN code of the Smartcard, if necessary.

### 2. Change Parental Rating:

Change the setting for the family filter, if necessary.

*Note :* This service is not offered by all channels.

### 3. Change Lock indicator:

You can change the lock status of the Smartcard.

### 4. Issuer Information:

Here you can call up all information stored on the Smartcard by the publisher.

### 5. Authorization:

This option would indicate the authorization status of the Smartcard.

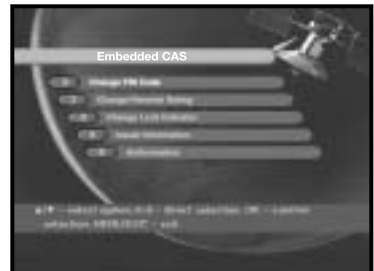

# TROUBLESHOOTING

Problem	Possible cause	Solution of the problem
No display LED on the front panel; No power supply	Power cord not plugged in correctly	Power cord plug in correctly
No pictures on the screen	Receiver in Standby mode; Scart not connected tightly to video output of television; incorrect channel or video output selected on television	Set receiver to "On"; Check connection and correct;  Check channel and video output and correct (TV instruction manual)
No sound	Audio cord connected incorrectly; Loudness level = 0; Muting active	Check connection and correct;  Increase loudness on television set; Press the MUTE key
Remote Control does not operate directly	incorrect operation;  Batteries dead or inserted incorrectly	Point remote control towards the Receiver. Replace batteries or insert correctly
Poor picture quality	Signal strength to low	Check the signal strength in the "Auto Scan" menu, correct alignment of your antenna
On-Screen Error Message "Searching for signal"	Antenna cable not connected or not tight; LNB defective; incorrect position of the satellite antenna;	Check connection and correct;  Change LNB; Check position and correct, Check the signal strength in the "Auto Scan" menu
On-Screen Error Message "Channel data does not exist."	Satellite not yet set	Scan of in "Automatic scanning" or "Manual scanning" menu
On-Screen Error Messages: "Please check the Smartcard"; "Please insert the Smartcard".	Smartcard: - not plugged in correctly; - not plugged in.	(depend on model) Check the Smartcard. "Insert the Smartcard."

## DISPOSAL

The device, packaging material (e.g. Styrofoam) and the batteries must never be disposed of with household refuse.

Please obtain appropriate information about the regulations in your community, and dispose of all refuse in accordance with regulations at the separate locations provided.



# TECHNICAL SPECIFICATIONS

## 1. User section

4000 programmable channels,  
software download via satellite &  
PC(Secured), advanced Electronic  
Program Guide, multi-language  
supported for OSD, DiSEqC 1.2  
supported full function infrared remote

control unit, 7 segment LED display,  
auto and manual scan facility,  
channel organizing (programmable),  
SCARTS & RCA output,  
low power consumption

## 2. Tuner section

950 ~ 2150 MHz wide band tuner,  
IF output with DC pass loop for analog  
receiver, supporting DiSEqC 1.2 version,

13 V/18 V switching,  
22 kHz continuous tone control

## 3. Video section

DVB-S compliant,  
MPEG-2 video (MP@ML)  
2 - 45 Ms/s symbol rate

modulator output,  
compatible for both SCPC/MCPC,  
supports aspect ratio 4:3 (normal) and  
16:9 (wide screen)

## 4. Audio section

MPEG 1 audio layer I & II  
mono, dual, stereo and joint stereo audio  
mode, 32, 44.1 and 48 kHz sampling

frequencies,  
volume control and mute function through  
Remote Control Unit.

## Power supply

Type:  
Input voltage:  
Fuse rating:

SMPS  
AC 100-240V ~, 50/60 Hz  
250 V/T2 A

## Tuner

Freq. Range:  
Input signal level:  
Channel selection:  
Input impedance:  
Connector type:  
LNB power control:  
DiSEqC:

950 ~ 2150 MHz  
-65 ~ -25 dBm  
PLL frequency synthesizer  
75  $\Omega$  unbalanced  
F type female  
13 V/18 V, 22 kHz tone  
1.2 supported

## Demodulator

Type:  
Symbol rate:  
Inner FEC:

QPSK DEMODULATION (DVB-S)  
2 ~ 45 Ms/s  
Viterbi Convolutional  
Coding Rate - 1/2,2/3,3/4,5/6,7/8  
Reed Solomon Coding (204,188) t, = 8

Outer FEC:

# TECHNICAL SPECIFICATIONS

## Video decoder

System decoding:	MPEG 2 ISO/TEC 13818 (transport stream)
Profile and level:	MPEG 2 MP@ML (4:2:2)
Data rate:	1~ 15 Mb/s
Video formats:	4:3 (normal) & 16:9 (widescreen)
Picture resolution:	720(H) x 576(V) x 50 fields/sec

## Audio Decoder

System decoding:	MPEG 1 ISO/TEC 11172~3 layer I & II
Audio mode:	mono, dual, stereo, joint stereo
Sampling frequency:	32, 44.1, 48 kHz

## A/V output

TV SCART:	VIDEO (CVBS, RGB), AUDIO R&L
VCR SCART:	VIDEO (CVBS), AUDIO R&L
RCA JACK:	VIDEO (CVBS), AUDIO R&L
SPDIF:	Digital Audio Output
S-VHS:	YC p_p 1Volt ( $\pm 10\%$ )

## RF modulator

Modulator output:	CH 21_69 (preset to CH 21)
Video type:	PAL B/G, K, I (preset to PAL B/G)
UHF output level:	$70 \pm 5$ dB $\mu$ V
Output connector:	IEC male
Ant. O/P connector:	IEC female
Tuning method:	PLL frequency synthesizer

### Serial data interface

Standard: RS232C, Max. 115.2 kB  
Connector type: 9 pin D-type female

### Internal modem (For models DSR 9510X, DSR 9510Y, DSR 9510Z)

External Modem Port: RS232C  
Connector Type: RJ-11 modular jack  
Data Rate: V.22 2400bps

This connector is for future purposes only.

### Embedded descrambler

2 slots, embedded CAS: Interface & descramble

**DSR 9500AX, DSR 9500AY, DSR 9510Y** and **DSR 9510X** models are valid for the Viaccess and CONAX smart card encryption at all.

Only a CONAX smart card can be used for **DSR 9500AZ** and **DSR 9510Z**.

### Common Interface (For models DSR 9500AY, DSR 9510Y, DSR 9500AZ, DSR 9510Z)

Module Type: PCMCIA TYPE II x 2  
Available CAM: VIACCESS, IRDETO, NAGRAVISION,  
CRYPTOWORKS, CONAX, SECA, Etc.